

# AGILITY™

## Planning Guide + Price List

---

### QUICK LINKS

[PLANNING GUIDE](#)

[AGILITY PRICING](#)

[POWER AND DATA OPTIONS](#)

[GENERAL INFORMATION](#)

[FINISH INFORMATION](#)

[SURFACE MATERIALS](#)



# STATEMENT OF LINE

## RECONFIGURABLE TABLES

---

Pages 15-16

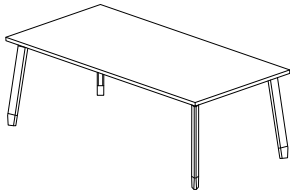

Rectangle

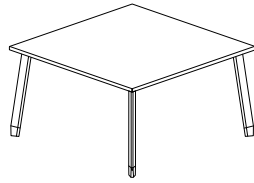

Square

## BRIDGE TABLES

---

Page 17-18

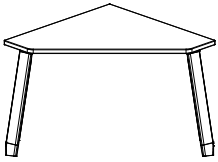

90° Bridge

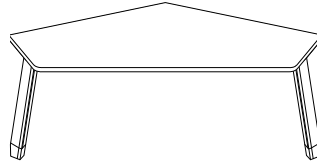

135° Bridge

## BRIDGE TOPS

---

Page 19-20



45° Bridge Top



# DETAIL OVERVIEW

Agility tables feature an elegant blending of form and function in a single product, supporting the needs of the table to be both changeable yet static. Crisp, clean lines create a signature statement wherever reconfigurable tables are needed. Whether the need is high-end modular tables, elegant conference tables, small meeting or café tables, or a combination achieved via reconfiguration, Agility offers a wide range of application choices.

## TOP MATERIALS

- Veneer with 3/16" deep hardwood edge
- Laminate with 3/16" deep hardwood edge
- Laminate with 2mm edge band

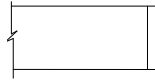

Hardwood Edge



Square Edge

## TOP SHAPES

### Reconfigurable Tables

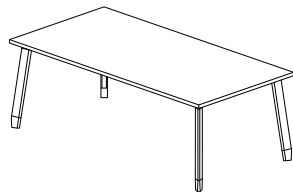

**Rectangle**  
 Depths: 26", 30", 36"  
 Widths: 60", 66", 72", 78", 84", 90", 96"

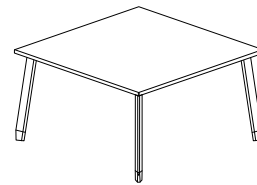

**Square**  
 Sizes: 36", 42", 48", 54", 60"

### Bridge Tables

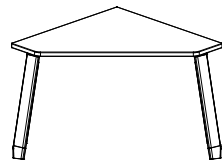

**90° Bridge Table**  
 Depths: 26", 30", 36"

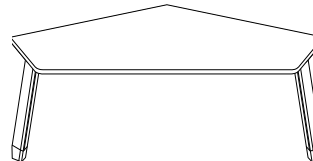

**135° Bridge Table**  
 Depths: 26", 30", 36"

Note: Bridge Tables only have two legs and are not freestanding. They are intended for use with Rectangle Reconfigurable Tables and must be secured to those tables with ganging connectors. Each Bridge Table includes two ganging connectors.

### Bridge Tops



**45° Bridge Top**  
 Depths: 26", 30", 36"

Note: Bridge Tops have no legs. They are intended for use with Rectangle Reconfigurable Tables and must be secured to those tables with ganging connectors. Each Bridge Top includes a two-direction ganging connector.



# GRAIN DIRECTION

Grain direction on Agility table tops always runs parallel to the longest side of the top, ensuring a continuous grain direction regardless of how the tables may be configured relative to each other.

Nucraft takes great pride in providing our customers with the best quality veneers available. However, it is important to note that wood is a natural material and, as such, is prone to natural color and grain variations. In some cases, color variation can occur due to metamerism (sometimes referred to as “flip”). This is an effect produced by wood where two very similar pieces appear to be different (one lighter, one darker) based on the viewing angle when the grain on each top is not running in a parallel direction relative to each other. As the viewing angle changes, the color of the wood appears to change (“flip”) with the lighter one becoming darker and vice versa. Because Agility Reconfigurable tables are intended to be rearranged into multiple configurations, grain direction may end up running in multiple directions as well, resulting in this effect.

Tables are not grain-matched. A grain-matched configuration can be requested by contacting our quote department. A drawing of the desired configuration is required.

## Reconfigurable Tables

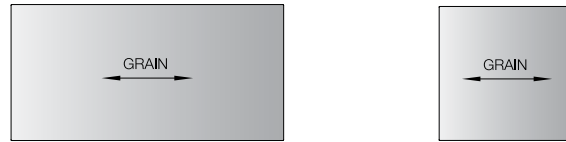

## Bridge Tables

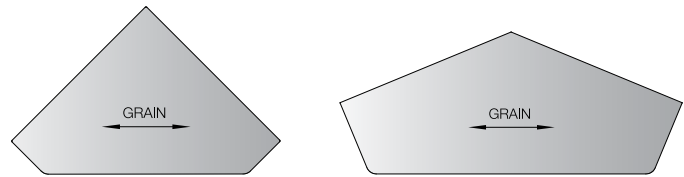

## Bridge Tops

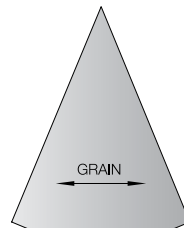

## Sample Configurations

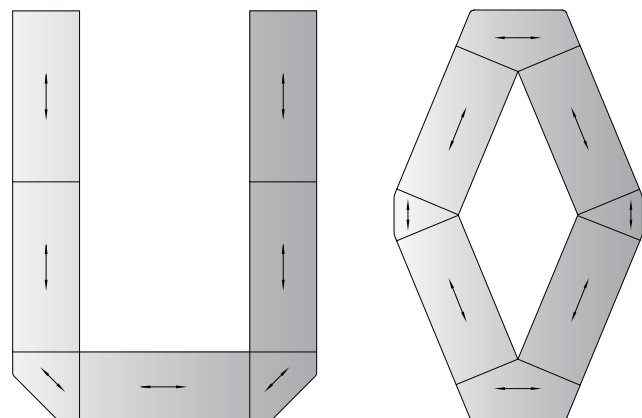



## LEG OPTIONS

### LEGS

The canted posture of the triangular-shaped legs creates a solid stance on individual tables, striking a delicate balance between a lightweight aesthetic and a sense of stability. This angled posture (8° tilt) creates a rhythm for when tables are joined together, as adjacent legs become a singular visual gesture. Legs are mounted at a 45° angle to the corner of the table such that, when paired with an adjacent table, the same relationship is formed no matter their orientation to one another. Each leg includes a wire management channel along the inside surface. A removable cap hides cables running from the floor. Note: When planning seating to coordinate with the table, clearance between table legs is approximately 10" less than the length of the table.

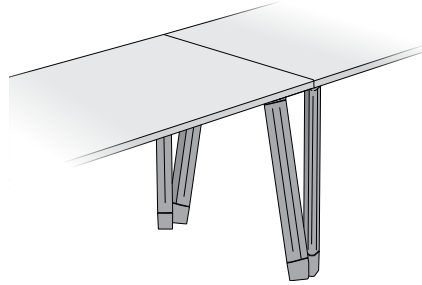

### LEG TYPES

Agility tables are available with two leg types; fixed and knock-down. When storage of tables is not a consideration, fixed legs provide a clean, permanent attachment to the table top. When the need exists to store unused Agility tables, the optional knock-down leg allows each table to be compressed into a minimal 5-1/4" thick package by removing the legs. This is accomplished by rotating the locking knob counter-clockwise to release the leg, removing the leg from the shoulder mount, and attaching the leg to the convenient leg pegs located on the underside of the table top. This compacted table, with the legs securely attached to the table top, can then be loaded onto the optional Agility dolly for transport.

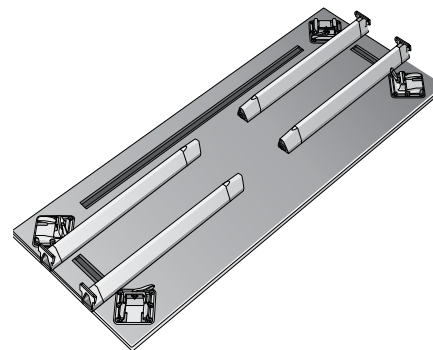
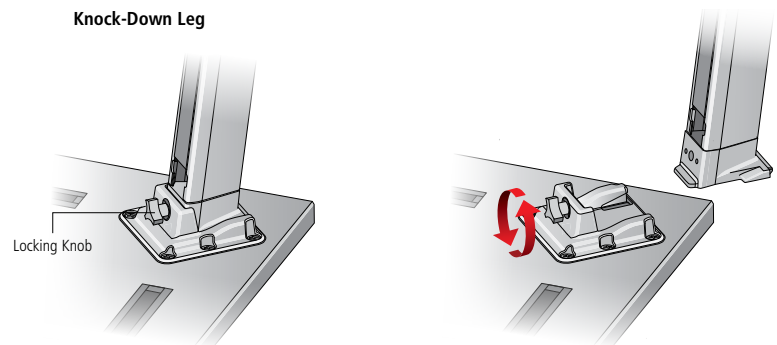

### CASTERS OR GLIDES

Agility can be specified with either glides or casters. Agility tables ship standard with glides, for applications when reconfiguration will not be frequent and a cleaner aesthetic is preferred. These glides feature a smooth, high tech polymer surface that all but eliminates friction for ease of movement on carpeted floors. When reconfiguration will be more frequent, the 3½-inch dual wheel casters with built-in brake mechanism allow tables to be easily repositioned. Both glides and casters are capable of being retrofitted in the field with no change in table height.

Glides

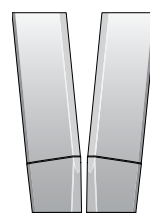

Castors

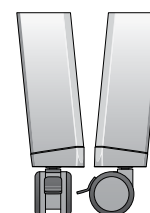



# GANGING AND MODESTY PANELS

## GANGING

When a secure connection between tables is required, Agility's low profile ganging connector can quickly and easily make a strong, mechanical connection between tables. Stored in a conveniently hidden mounting track on the underside of the Agility table, the ganging connector simply swings over to the adjacent table and, with a few turns of the low-profile rubber knob, locks the device in the track of the other table. When specified, each Agility table includes two ganging connectors. Because every Agility table includes the mounting track on the underside of the top, these ganging connectors can also be retrofitted in the field.

Agility tables can be ganged end-to-end, front-to-front and front-to-end.

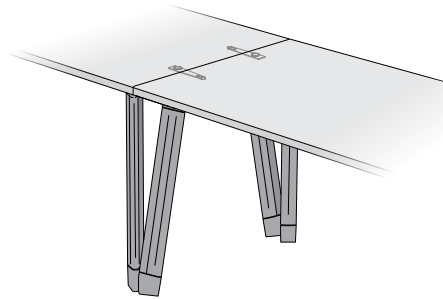

Not Engaged

Engaged

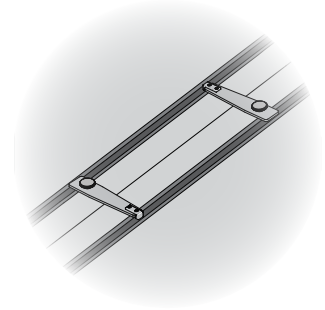
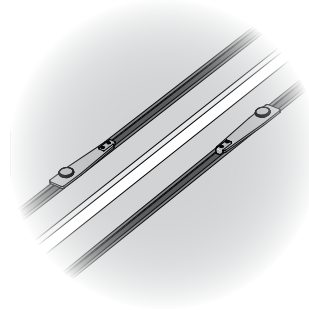

## MODESTY PANELS

Agility tables can be specified with or without modesty panels. Modesty panels are offered in veneer or painted options, and extend to within 1/8" of the edge of the table top, minimizing the gap between adjacent modesty panels for a refined aesthetic when tables are ganged together. The modesty panel mounting brackets attach to the hidden mounting track on the underside of the table, allowing for modesty panels to also be retrofittable in the field. There is a 3/4" gap between the top of the modesty panel and the underside of the table top to allow clearance for cables and ganging connectors. A black brush material provides a visual block in this 3/4" gap.

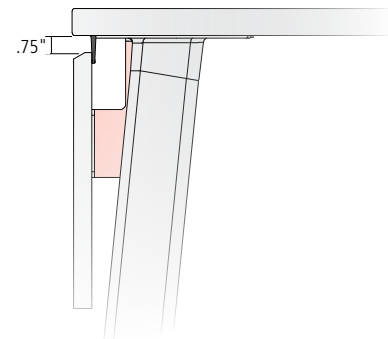
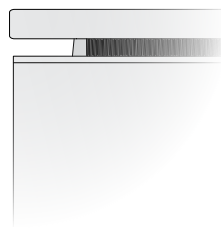
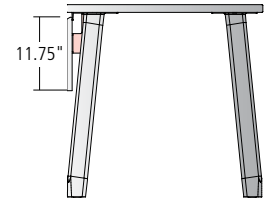



# TABLE TOP POWER OPTIONS

From simple to heavy duty, Agility can handle a wide range of power & data connectivity.

## POWER AND DATA INFEEED

Each Agility table comes standard with a wire management channel on the inside of each leg (1.25" x .75" running vertically up the leg). This channel includes a removable aluminum cap and hides cables running from the floor to the wire management trough.

## WIRE MANAGEMENT TROUGH

All Agility tables ordered with a table top power option include a wire management trough Under Surface to covertly manage cables between tables.

## TABLE TOP POWER

For easy access to power & data connectivity, the power options available on Agility table tops include:

### Grommet

- 2" Removable metal cap
- Mounted flush to the table top

### Tech Node

- Clear or Black Anodized Aluminum
- Fluid one touch accessibility
- Overall dimensions - 4-7/16" x 8-5/16"
- Power: - 2 simplex receptacles
  - 12' 15-Amp plug-in power infeed (3' cord when specified with two-circuit modular power system)
  - UL Listed
- Voice/Data: Up to two mounting locations (includes adaptor kits)
- Optional powered USB-A+C

Wire Management Channel

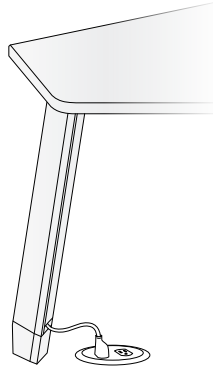

Wire Management Trough

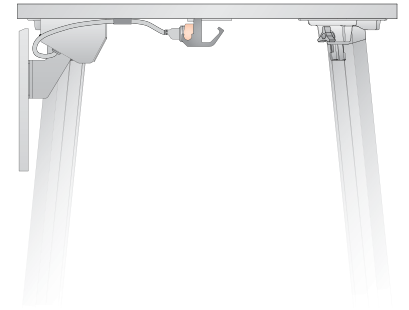

Grommet

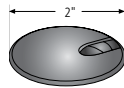

Tech Node - Cover Open

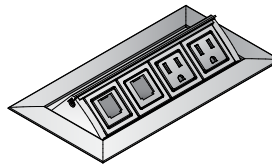

Tech Node - Cover Open with Optional USB-A+C

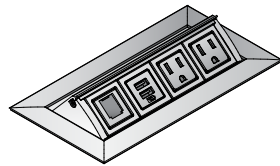

Tech Node - Cover Closed

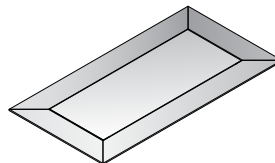

Tech Node - Open Front View

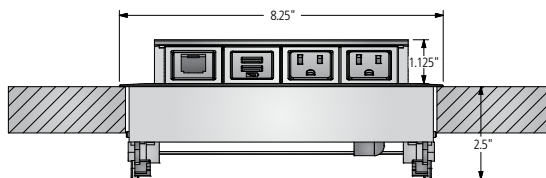

Tech Node - Open Side View

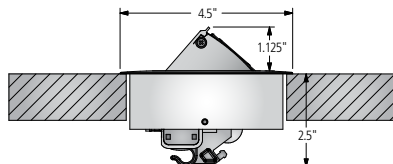



# TABLE TOP POWER OPTIONS

Power Matrix is filled with a broad array of high performance features and refined aesthetic elements.

## POWER

Power Matrix features two simplex receptacles for power connectivity. An optional USB-A+C charger can also be specified in place of one of the simplex receptacles when desired. Corded or hardwired infeed options add flexibility.

## DATA/AV FACEPLATES

Power Matrix accommodates Modular AV Inserts/Plates for unparalleled flexibility in data and AV connectivity.

## DESIGN

Power Matrix units feature a clear anodized aluminum body and a bezel-free flush mount design on wood tables for an elegant appearance. Laminate table tops include a bezel, available in powder coat, polished chrome or clear anodized finish options.

## PERFORMANCE

Friction hinges ensure smooth travel through the door's range of motion and can hold the door in any position. Hidden door stops maintain the minimalist aesthetic.

## DOORS

Power Matrix is offered in multiple door material options, including metal, glass and grain-matched wood cut from the same table top.

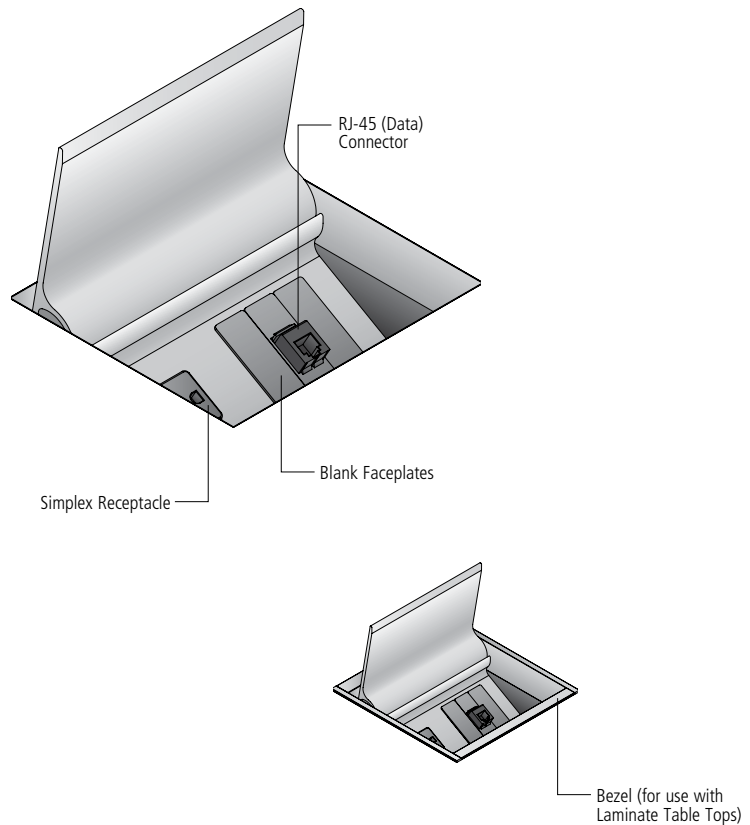



# TABLE TOP POWER OPTIONS

## STANDARD CONFIGURATION

Power Matrix is offered with a pre-determined quantity of simplex outlets and AV faceplates. An optional 2 amp USB-A+C charger (1 amp per port) replaces one of the simplex outlets.

### Compact

- Single door design
- 5.375" x 6" cutout
- Two simplex outlets
- Three AV faceplates. Standard configuration includes two blank faceplates & one faceplate with two RJ-45 (data) connectors.
- (1) 12' plug-in infeed cord

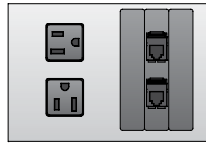

## DIMENSIONS

The compact Power Matrix unit includes a low-profile pan beneath the work surface to conceal the unit.

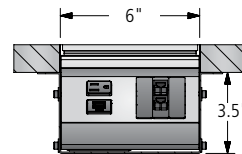
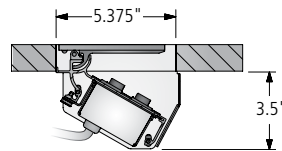

## FIELD-WIRED

Some local electrical codes may require field-wiring during installation. In such instances, a Field-Wired option may be specified. In this configuration, each Power Matrix unit will be supplied with a 6' flexible metal conduit with hot, ground and neutral wires.

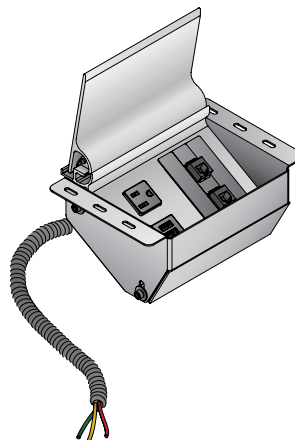



# UNDER SURFACE POWER OPTIONS

If additional power connectivity between tables is desired, two options are offered under surface:

### Plug Strip

- Inexpensive, flexible means of providing power outlets

### Two-Circuit Modular Power System

- 4-wire, 2-circuit modular system (20 amps)
- Transfers power between adjacent tables from a single point of entry
- Hardwired (2-circuit capability) or direct plug infeed (1-circuit capability) options. Power infeeds must be ordered separately.
- All components, except the direct plug infeed, are UL and cULus listed and meet NEC requirements; the direct plug infeed is not UL listed but does meet NEC standards.
- Each table ships with two duplex receptacles, as well as one jumper to connect to an adjacent table.
- Neutral (white) wires are 10 gauge, hot and ground wires are 12 gauge

Electrical Diagram — Hardwire Power Infeed Only

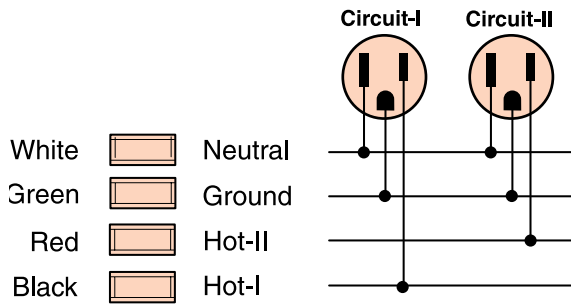

20-Amp Plug-In Infeed

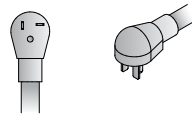

Hardwire Infeed





# FREESTANDING POWER OPTION: TECH ZONE

## TECH ZONE

Simple, easy to use and portable, this freestanding table top power option allows you to easily charge all of your devices.

Available in two configurations with a variety of power and data connectivity options. Includes a 72"-long plug-in infeed cord.

### ZONE-USB-C

Includes two simplex receptacles, one data port and one charging USB-A+C charging port

### ZONE-DATA

Includes two simplex receptacles and two open data ports

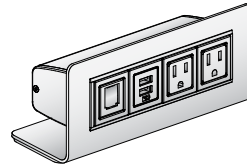

Tech Zone - Side View

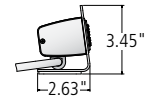

ZONE-USB-C



ZONE-DATA





# POWER LOCATION OPTIONS

## GROMMETS, TECH NODE AND POWER MATRIX LOCATION OPTIONS

### Rectangle

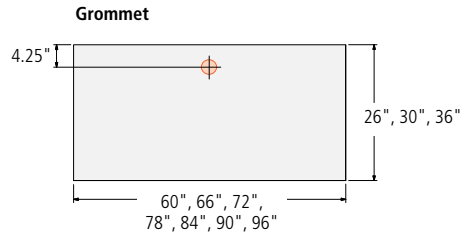

### Square

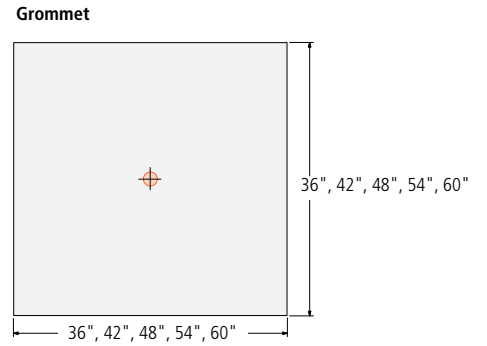

### Tech Node

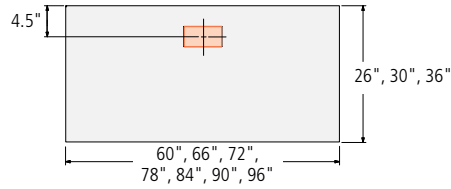

### Tech Node

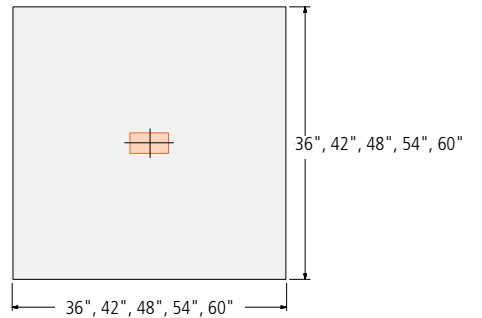

### Power Matrix

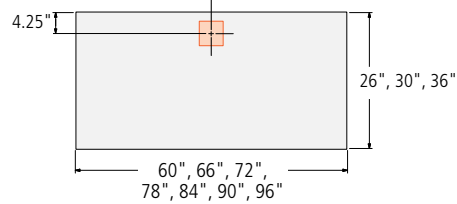

### Power Matrix

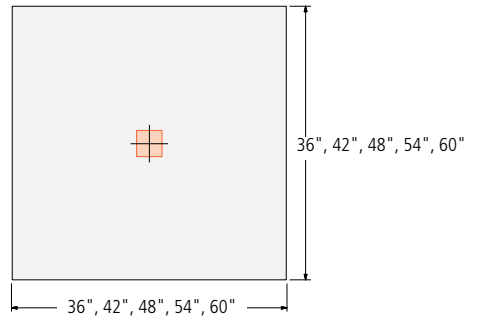



# POWER LOCATION OPTIONS

## GROMMETS, TECH NODE AND POWER MATRIX LOCATION OPTIONS

### 135-Degree Bridge

Grommet

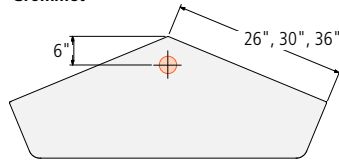

Tech Node

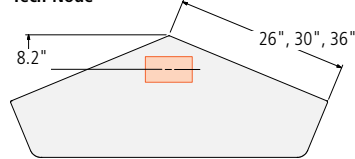

Power Matrix

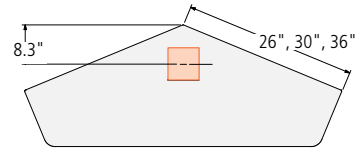

135-Degree Bridge Dimensions

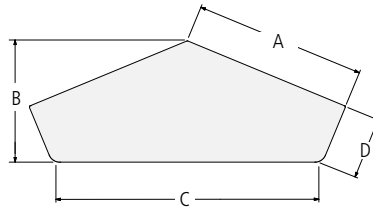

A	B	C	D
26"	23.8"	33.9"	15"
30"	25.3"	41.3"	15"
36"	27.6"	52.4"	15"



# CONFIGURATION EXAMPLES

With a simple vocabulary of pragmatic shapes, Agility is able to create a wide range of configuration options to address a broad array of application needs.

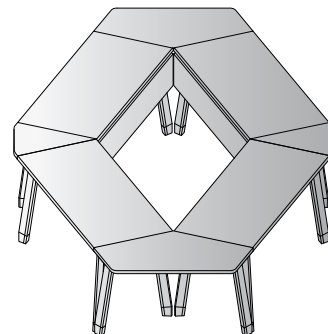
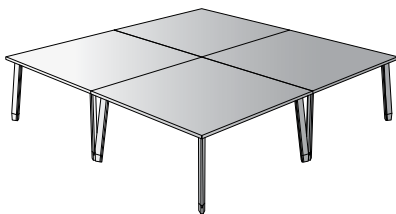
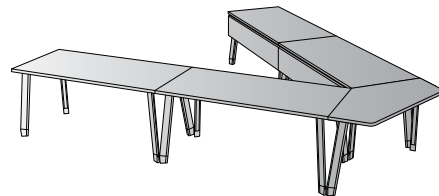
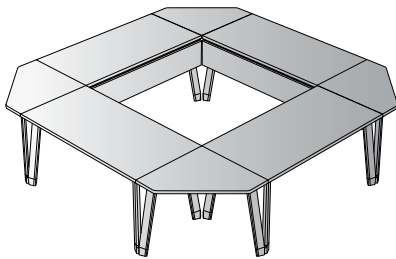
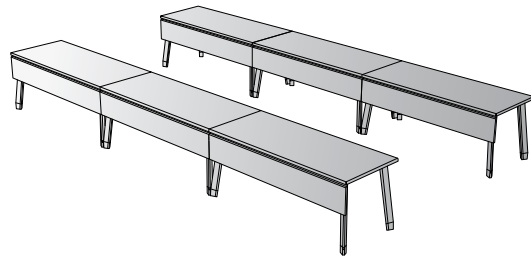
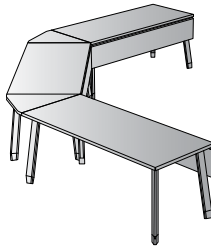
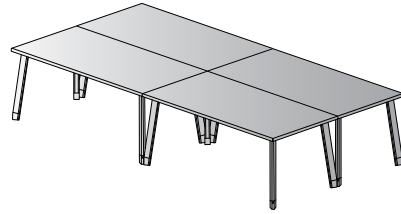
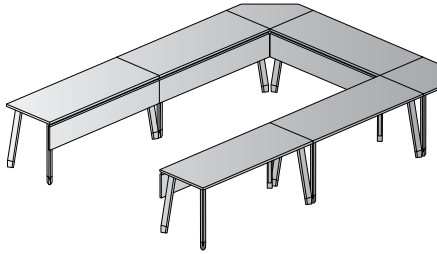



# RECONFIGURABLE TABLES

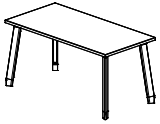

RECTANGLE TOP  
FIXED LEG OR KNOCK-DOWN LEG

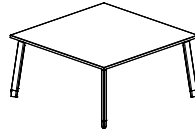

SQUARE TOP  
FIXED LEG OR KNOCK-DOWN LEG

## TOP SURFACE MATERIAL KEY

3MP	Laminate Top with Square Edge
SQP	Laminate Top with Square Wood Edge
SQ	Veneer Top with Square Wood Edge

### RECTANGLE TABLE // FIXED LEG // EDGE-MOUNTED

MODEL #	DEPTH	WIDTH	-3MP	-SQP	-SQ
<b>WITHOUT MODESTY PANEL</b>					
AGF-2660-FE	26	60	3,606	3,966	4,269
AGF-2666-FE	26	66	3,733	4,127	4,457
AGF-2672-FE	26	72	3,857	4,285	4,645
AGF-2678-FE	26	78	3,985	4,448	4,835
AGF-2684-FE	26	84	4,113	4,608	5,023
AGF-2690-FE	26	90	4,237	4,768	5,212
AGF-2696-FE	26	96	4,366	4,927	5,401
AGF-3060-FE	30	60	3,802	4,213	4,559
AGF-3066-FE	30	66	3,944	4,398	4,776
AGF-3072-FE	30	72	4,091	4,584	4,993
AGF-3078-FE	30	78	4,237	4,768	5,212
AGF-3084-FE	30	84	4,386	4,954	5,427
AGF-3090-FE	30	90	4,531	5,139	5,648
AGF-3096-FE	30	96	4,677	5,322	5,865
AGF-3672-FE	36	72	4,443	5,030	5,516
AGF-3678-FE	36	78	4,619	5,250	5,777
AGF-3684-FE	36	84	4,793	5,472	6,041
AGF-3690-FE	36	90	4,967	5,693	6,300
AGF-3696-FE	36	96	5,144	5,915	6,564

### RECTANGLE TABLE // KNOCK-DOWN LEG // EDGE-MOUNTED

MODEL #	DEPTH	WIDTH	-3MP	-SQP	-SQ
<b>WITHOUT MODESTY PANEL</b>					
AGF-2660-KE	26	60	5,182	5,545	5,846
AGF-2666-KE	26	66	5,307	5,705	6,033
AGF-2672-KE	26	72	5,436	5,864	6,222
AGF-2678-KE	26	78	5,561	6,023	6,412
AGF-2684-KE	26	84	5,689	6,186	6,602
AGF-2690-KE	26	90	5,815	6,346	6,790
AGF-2696-KE	26	96	5,941	6,505	6,976
AGF-3060-KE	30	60	5,376	5,788	6,134
AGF-3066-KE	30	66	5,523	5,976	6,353
AGF-3072-KE	30	72	5,668	6,160	6,569
AGF-3078-KE	30	78	5,815	6,346	6,790
AGF-3084-KE	30	84	5,962	6,531	7,006

### SQUARE TABLE // FIXED LEG // EDGE-MOUNTED

MODEL #	DEPTH	WIDTH	-3MP	-SQP	-SQ
AGS-3636-FE	36	36	3,391	3,694	3,948
AGS-4242-FE	42	42	3,772	4,177	4,516
AGS-4848-FE	48	48	4,210	4,730	5,169
AGS-5454-FE	54	54	4,707	5,360	5,908
AGS-6060-FE	60	60	5,261	6,063	6,736

### SQUARE TABLE // KNOCK-DOWN LEG // EDGE-MOUNTED

MODEL #	DEPTH	WIDTH	-3MP	-SQP	-SQ
AGS-4848-KE	48	48	5,785	6,308	6,743
AGS-5454-KE	54	54	6,284	6,936	7,486



# RECONFIGURABLE TABLES

OPTIONS	CODE	PRICE	NOTES
<b>Painted Modesty Panel Options:</b>			
60" Long	-PM60	\$1,329	Note: Modesty Panels are only available on Rectangle tables.
66" Long	-PM66	\$1,383	
72" Long	-PM72	\$1,443	
78" Long	-PM78	\$1,767	
84" Long	-PM84	\$1,832	
90" Long	-PM90	\$1,901	
96" Long	-PM96	\$1,966	
<b>Wood Modesty Panel Options:</b>			
60" Long	-WM60	\$1,564	Note: Modesty Panels are only available on Rectangle tables. Wood Modesty Panels are available with Hardwood Edge, and will match the finish of the edge.
66" Long	-WM66	\$1,633	
72" Long	-WM72	\$1,696	
78" Long	-WM78	\$1,729	
84" Long	-WM84	\$1,761	
90" Long	-WM90	\$1,827	
96" Long	-WM96	\$1,890	
Locking Casters	Add -LC	No Charge	- Includes two Ganging Connectors per table - Ganging Connectors are for end-to-end, front-to-front and front-to-end connections
High Polish Leg Finish	Add -HPFA	Add \$1,130 per table	
Ganging Connectors	Add -GCA	Add \$333 per table	
<b>Under Surface Power and Data Options (specify only one option from below):</b>			
Modular Power System	Add -MOD	Add \$488 per table	- Only available on Rectangle tables - Includes two duplex receptacles per table and one jumper to connect to adjacent table - Power infeed must be specified separately (see page 23)
Plug Strip	Add -PLUG	Add \$176 per table	
<b>Table Top and Freestanding Power and Data Options:</b>			See pages 22-25

## EDGE PROFILES

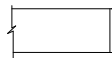

SQUARE EDGE  
-3MP

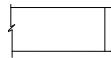

SQUARE WOOD EDGE  
-SQP or -SQ

## GENERAL INFORMATION

- Tables are not grain-matched. A grain-matched configuration can be requested by contacting our quote department.
- Overall table height 29-1/2"
- Tops are 1-1/8" thick
- Tables ship standard with glides
- If tables are planned to be ganged to other tables, the ganging connector option must be specified
- When table storage is required, the Knock Down (KD) Leg option allows legs to be removed and attached to the bottom of the table creating a compact 5-1/4" thick package for storage
- Caster color will default based on leg finish (High Polish Finish, Cloud, Burnished, and Foil legs have Smoke casters; Shadow and Galaxy legs have Black casters)
- Standard veneer tops feature quarter cut veneers

### REQUIRED INFORMATION (ORDER CANNOT BE ENTERED WITHOUT THIS INFORMATION)

See appendix pages vi-vii for surface material options.

#### Laminate Top with Square Edge (-3MP)

- Choose Laminate
- Choose Edge Band Finish
- Choose Leg Finish. Add \$1,130 per table for HPFA option.
- Choose Painted Modesty Color, if selected

#### Laminate Top with Square Wood Edge (-SQP)

- Choose Laminate
- Choose Veneer Finish
- Choose Leg Finish. Add \$1,130 per table for HPFA option.
- Choose Painted Modesty Color, if selected

#### Veneer Top with Square Wood Edge (-SQ)

- Choose Veneer Finish (Note: Tables are not grain-matched)
- Choose Leg Finish. Add \$1,130 per table for HPFA option.
- Choose Painted Modesty Color, if selected



# BRIDGE TABLES AND TOPS

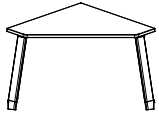

90-DEGREE FIXED LEG

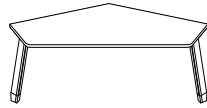
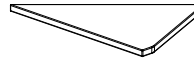
135-DEGREE  
FIXED LEG OR KNOCK-DOWN LEG

45-DEGREE BRIDGE TOP

## TOP SURFACE MATERIAL KEY

3MP	Laminate Top with Square Edge
SQP	Laminate Top with Square Wood Edge
SQ	Veneer Top with Square Wood Edge

### 90-DEGREE BRIDGE TABLE // FIXED LEG // EDGE-MOUNTED

MODEL #	DEPTH	-3MP	-SQP	-SQ
AGB90-26-FE	26	2,027	2,269	2,469
AGB90-30-FE	30	2,285	2,595	2,856
AGB90-36-FE	36	2,742	3,172	3,534

### 135-DEGREE BRIDGE TABLE // FIXED LEG // EDGE-MOUNTED

MODEL #	DEPTH	-3MP	-SQP	-SQ
AGB135-26-FE	26	2,078	2,332	2,543
AGB135-30-FE	30	2,350	2,678	2,950
AGB135-36-FE	36	2,833	3,287	3,668

### 135-DEGREE BRIDGE TABLE // KNOCK-DOWN LEG // EDGE-MOUNTED

MODEL #	DEPTH	-3MP	-SQP	-SQ
AGB135-26-KE	26	2,866	3,120	3,331
AGB135-30-KE	30	3,138	3,465	3,737

### 45-DEGREE BRIDGE TOP

MODEL #	DEPTH	-3MP	-SQP	-SQ
AGB45-26	26	901	1,142	1,341
AGB45-30	30	1,160	1,470	1,725
AGB45-36	36	1,615	2,046	2,407



# BRIDGE TABLES AND TOPS

OPTIONS	CODE	PRICE	NOTES
Locking Casters	Add <b>-LC</b>	No Charge	
High Polish Leg Finish	Add <b>-HPFA</b>	Add \$566 per table	
<b>Under Surface Power and Data Options (specify only one option from below):</b>			
Modular Power System (135-Degree Bridge Table)	Add <b>-MOD</b>	Add \$488 per table	- Includes two duplex receptacles per table and one jumper to connect to adjacent table - Power infeed must be specified separately (see page 23)
Modular Power System (90-Degree Bridge Table and 45-Degree Bridge Top)	Add <b>-MODJ</b>	Add \$240 per table	- Includes one jumper to connect to adjacent table - Power infeed must be specified separately (see page 23)
Plug Strip	Add <b>-PLUG</b>	Add \$176 per table	
<b>Table Top and Freestanding Power and Data Options:</b>			See pages 22-25
Table top power options not available on 90-Degree Bridge Tables or 45-Degree Bridge Tops			

## EDGE PROFILES



SQUARE EDGE  
-3MP

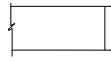

SQUARE WOOD EDGE  
-SQP or -SQ

## GENERAL INFORMATION

- Tables are not grain-matched. A grain-matched configuration can be requested by contacting our quote department.
- Overall table height 29-1/2"
- Tops are 1-1/8" thick
- Tables ship standard with glides
- If tables are planned to be ganged to other tables, the ganging connector option must be specified
- When table storage is required, the Knock Down (KD) Leg option allows legs to be removed and attached to the bottom of the table creating a compact 5-1/4" thick package for storage
- Caster color will default based on leg finish (High Polish Finish, Cloud, Burnished, and Foil legs have Smoke casters; Shadow and Galaxy legs have Black casters)
- Standard veneer tops feature quarter cut veneers
- Bridge Tables and Tops include ganging connectors

### REQUIRED INFORMATION (ORDER CANNOT BE ENTERED WITHOUT THIS INFORMATION)

See appendix pages vi-vii for surface material options.

#### Laminate Top with Square Edge (-3MP)

- Choose Laminate
- Choose Edge Band Finish
- Choose Leg Finish. Add \$566 per table for HPFA option.

#### Laminate Top with Square Wood Edge (-SQP)

- Choose Laminate
- Choose Veneer Finish
- Choose Leg Finish. Add \$566 per table for HPFA option.

#### Veneer Top with Square Wood Edge (-SQ)

- Choose Veneer Finish (Note: Tables are not grain-matched)
- Choose Leg Finish. Add \$566 per table for HPFA option.



# DOLLIES



S-DOLLY

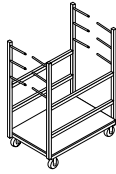

S-DOLLY-R

## MOBILE TABLE STORAGE DOLLY

MODEL #	DESCRIPTION	W x D x H	PRICE
SDOLLY	Standard dolly	48 x 31 x 39-1/2	4,410
SDOLLY-R	With Modesty Panel Racks	48 x 31 x 68-1/2	5,354

## GENERAL INFORMATION

- 6" casters
- Black finish
- Accommodates all table sizes
- Five table capacity per dolly
- Optional modesty panel rack holds six modesty panels
- Shipped Set-up
- Dollies are for use with knock-down leg tables only



# ACCESSORIES

CASTERS	MODEL #	DESCRIPTION	PRICE
	AG-CST	Casters, set of 4	402

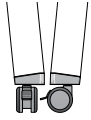

### GENERAL INFORMATION

- For retrofitting in the field
- All four casters feature lock
- Wheels are hard ABS edge

**REQUIRED INFORMATION: (ORDER CANNOT BE ENTERED WITHOUT THIS INFORMATION)**

- See appendix pages vi-vii for surface material options.
- Choose Caster Color: Black or Smoke
  - Choose Metal Collar color. Add \$74 for HPFA option.

GLIDES	MODEL #	DESCRIPTION	PRICE
	AG-GLD	Glides, set of 4	402

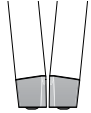

### GENERAL INFORMATION

- For retrofitting in the field
- All four glides include an adjustable glide with 1-1/4" range

**REQUIRED INFORMATION: (ORDER CANNOT BE ENTERED WITHOUT THIS INFORMATION)**

- See appendix pages vi-vii for surface material options.
- Choose Glide Finish. Add \$74 for HPFA option.

GANGING CONNECTOR	MODEL #	DESCRIPTION	PRICE
	AG-GNG	Ganging Connectors, set of 2	334

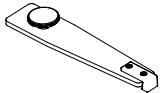

### GENERAL INFORMATION

- For retrofitting in the field

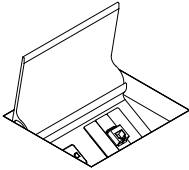

# POWER AND DATA OPTIONS

POWER MATRIX COMPACT	MODEL #	DESCRIPTION	W x D	SIMPLEX OUTLETS	BLANK	DATA*	PRICE
	PM-SM-G-C	Small - Glass Door	6 x 5.375	2	2	1	1,635
	PM-SM-M-C	Small - Metal Door	6 x 5.375	2	2	1	1,635
	PM-SM-W-C	Small - Wood Door	6 x 5.375	2	2	1	2,062

\*Each data faceplate includes two RJ-45 (Data) connectors

OPTIONS	CODE	PRICE	NOTES
4 Simplex Receptacles	Add <b>-FOUR</b>	No Charge	Replace Modular AV Inserts/Plates with 2 simplex receptacles
3 Simplex Receptacles/Charging USB-A+C	Add <b>-THREE-C</b>	No Charge	Replace Modular AV Inserts/Plates with 1 simplex receptacle and 1 charging USB-A+C
USB-A+C Charging	Add <b>-USB-C</b>	\$128 per unit	USB-A+C charger, replaces one of the simplex outlets
Polished Chrome Door	Add <b>-PD</b>	\$245 per unit	Only available with metal door option
Polished Chrome Bezel	Add <b>-PB</b>	\$349 per unit	Only available on laminate top tables
Field-Wired	Add <b>-FW</b>	Deduct \$48 per unit	May be required in New York City, Chicago and San Francisco. Check with an electrician for local codes and requirements.

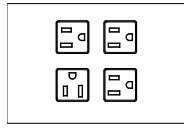

-FOUR

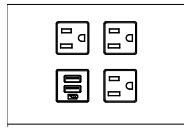

-THREE-C

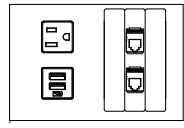

-USB-C

### GENERAL INFORMATION

- Wood species and finish will default to the same as the table top if wood door version is specified
- Glass & wood doors are 1/4" -thick, metal doors are 1/8" -thick
- Glass door is back-painted low-iron glass
- Interior body is clear anodized aluminum
- Each unit includes a 15 amp, 12' power infeed (plug in only). If specified with modular power, the infeed will be 3' long.
- Standard configuration: Two simplex receptacles, two RJ-45 data connectors and two single blank faceplates
- When specified on tables with laminate tops, each Power Matrix unit will include a metal bezel and is limited to the glass and metal door options. (-B) will be added to the model number for the bezel.
- Additional data/AV faceplate options are below

### REQUIRED INFORMATION: (ORDER CANNOT BE ENTERED WITHOUT THIS INFORMATION)

- See appendix pages vi-vii for surface material options.
- Choose Glass Door Finish, if glass door version is specified
  - Choose Metal Finish, if metal door version is specified or for the bezel finish on laminate tables

DATA FACEPLATES	MODEL #	DESCRIPTION	STYLE	W x H	PRICE
	FLDF-1	Blank faceplate, single height	Single	3-1/2 x 5/8	81
	FLDF-2	One VGA 15-pin HD Female to Female Gender Changer, one 3.5mm Stereo Mini Jack to Solder Tabs	Single	3-1/2 x 5/8	284
	FLDF-3	One VGA 15-pin HD Female to Female Gender Changer	Single	3-1/2 x 5/8	223
	FLDF-4	One RJ-11 Female to Punch Down - Phone	Single	3-1/2 x 5/8	223
	FLDF-5	One RJ-45 Female to Female Barrel - Data	Single	3-1/2 x 5/8	182
	FLDF-6	Two RJ-45 Female to Female Barrels, single height	Single	3-1/2 x 5/8	244
	FLDF-7	Two RJ-45 Female to Punch Down for CAT 6 - AMP	Single	3-1/2 x 5/8	345
	FLDF-8	Two RJ-45 Female to Punch Down for CAT 6 - Leviton	Single	3-1/2 x 5/8	345
	FLDF-10	Two RJ-45 Female to Punch Down for CAT 6 - Panduit	Single	3-1/2 x 5/8	345
	FLDF-11	Two USB A Female to Two USB A Female on 10" Pigtailed	Single	3-1/2 x 5/8	386
	FLDF-12	Blank faceplate, double height	Double	3-1/2 x 1-3/8	101
	FLDF-13	Two RJ-45 Female to Female Barrels, double height	Double	3-1/2 x 1-3/8	244
	FLDF-14	Cable Pass-Through Set - one top, one bottom	Double	3-1/2 x 1-3/8	426
	FLDF-15	One HDMI Female to Female Barrel	Single	3-1/2 x 5/8	284

### GENERAL INFORMATION

- Faceplates are black

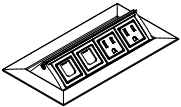

# POWER AND DATA OPTIONS

TECH NODE	MODEL #	W X D	SIMPLEX RECEPTACLES	OPEN DATA PORTS	CHARGING USB-A+C	PRICE
 PUP	PUP	8 x 4	2	2	-	597
	PUP-USB-AC	8 x 4	2	1	1	711

OPTIONS	CODE	PRICE	NOTES
Field-Wired	Add <b>-FW</b>	No Charge	May be required in New York City, Chicago and San Francisco. Check with an electrician for local codes and requirements.

**GENERAL INFORMATION**

- PUP option includes two simplex receptacles and two voice/data openings
- PUP-USB-C option includes two simplex receptacles, one USB-A+C charger and one voice/data opening
- 12' 15-Amp plug-in power infeed standard. 3' cord when specified with modular power system (UL Listed).
- Voice/data modules must be ordered separately; contact your local AV integrator
- PUP defaults to color of metal finish specified on tables (Shadow, Storm, Black, Aged Bronze, Satin Bronze and Galaxy receive Black Anodized Tech Node; Cloud, Burnished and Foil receive Clear Anodized Tech Node)
- UL listed
- Not available on 90-Degree Bridge Tables or 45-Degree Bridge Tops
- Center of Table option only available on Square Tables
- Includes a Voice/Data Adapter Kit to accept couplers and jacks when required

GROMMET	MODEL #	DESCRIPTION	DIAMETER	PRICE
 GR	GR	Round Grommet	2" Dia	242

OPTIONS	CODE	PRICE	NOTES
Polished Chrome Grommet	Add <b>-PCG</b>	\$98 per unit	

**GENERAL INFORMATION**

- Not available on 90-Degree Bridge Tables or 45-Degree Bridge Tops
- Center of Table option only available on Square Tables
- Metal finish will default to metal finish on table

**REQUIRED INFORMATION: (ORDER CANNOT BE ENTERED WITHOUT THIS INFORMATION)**  
 See appendix pages vi-vii for surface material options.

- Choose Metal Finish: Powder Coat, Clear Anodized or Polished Chrome (upcharge applies)

MODULAR POWER SYSTEM POWER INFEEDES	MODEL #	DESCRIPTION	PRICE
 AGP-H	AGP-H	Hardwire Power Infeed (20 amp)	168
	AGP-P	Plug-In Power Infeed (20 amp)	225
	AGP-P-SPLUG	Plug-In Power Infeed (20 amp) Straight Plug Head	225

**GENERAL INFORMATION**

- Plug-in power infeed will only utilize one circuit of the two-circuit modular power system. To utilize both circuits, the hardwire power infeed must be specified.
- Power infeeds can be placed at any location along a string of connected tables
- Plug-in power infeed can accommodate a maximum of 6 tables per infeed. Hardwire power infeed can accommodate a maximum of 12 tables per infeed.

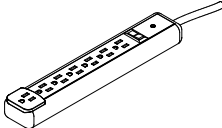
PLUG STRIP RETROFIT KIT	MODEL #	W x D x H	PRICE
 MOA-10	MOA-10	2.05 x 11.69 x 1.32	201

**GENERAL INFORMATION**

- 15 amps - Mounts into Wire Trough
- Includes (7) outlets, surge protection and 12' electrical cord



# POWER AND DATA OPTIONS

## MODULAR POWER SYSTEM RETROFIT KITS - RECTANGLE TABLES

MODEL #	PRICE
AG-MOD60R	476
AG-MOD66R	476
AG-MOD72R	476
AG-MOD78R	476
AG-MOD84R	476
AG-MOD90R	476
AG-MOD96R	476

OPTIONS	CODE	PRICE	NOTES
Two-Circuit Version	Add <b>-2CIR</b>	No Charge	- Includes two receptacles, each accessing a different circuit - Only works with hardwired power infeeds

### GENERAL INFORMATION

- Includes two receptacles (each on the same circuit unless the -2CIR option is specified) and one jumper to connect to adjacent table
- Standard version works with either hardwired or direct plug-in power infeeds (unless -2CIR option is selected, in which case it only works with hardwired power infeeds)

## MODULAR POWER SYSTEM RETROFIT KITS - 90-DEGREE BRIDGE TABLES

MODEL #	PRICE
AG-MOD90B26	243
AG-MOD90B30	243
AG-MOD90B36	243

### GENERAL INFORMATION

- Includes a jumper to connect to adjacent tables
- Works with either hardwired or direct plug-in power infeeds

## MODULAR POWER SYSTEM RETROFIT KITS - 135-DEGREE BRIDGE TABLES

MODEL #	PRICE
AG-MOD135B26	476
AG-MOD135B30	476
AG-MOD135B36	476

OPTIONS	CODE	PRICE	NOTES
Two-Circuit Version	Add <b>-2CIR</b>	No Charge	- Includes two receptacles, each accessing a different circuit - Only works with hardwired power infeeds

### GENERAL INFORMATION

- Includes two receptacles (each on the same circuit unless the -2CIR option is specified) and one jumper to connect to adjacent table
- Standard version works with either hardwired or direct plug-in power infeeds (unless -2CIR option is selected, in which case it only works with hardwired power infeeds)

## MODULAR POWER SYSTEM RETROFIT KITS - 45-DEGREE BRIDGE TOPS

MODEL #	PRICE
AG-MOD45B26	243
AG-MOD45B30	243
AG-MOD45B36	243

### GENERAL INFORMATION

- Includes a jumper to connect to adjacent tables
- Works with either hardwired or direct plug-in power infeeds



# FREESTANDING POWER OPTION

TECH ZONE	MODEL #	DESCRIPTION	SIMPLEX OUTLETS	OPEN DATA PORTS	CHARGING USB A+C	PRICE
	ZONE-DATA	(2) Simplex receptacles, (2) Open data ports	2	2	-	375
	ZONE-USB-C	(2) Simplex receptacles, (1) charging USB A+C, (1) Open data port	2	1	1	449

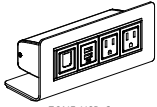

ZONE-USB-C



ZONE-DATA



ZONE-USB-C

## GENERAL INFORMATION

- 72" long plug-in infeed cord
- Finish is black
- Includes a Voice/Data Adapter Kit to accept couplers and jacks when required



# Appendix

---



# GENERAL INFORMATION

This price book supercedes all previous versions.

**Before placing your order, confirm you have all required information necessary. Lead times for orders begin after all required information is included and correct.**

## Delivery Information

We know lead times are important and sticking to them even more so. We work to maintain a 6-8 week lead time on all standard products in this book from receipt of a clean order. All orders are acknowledged with an approximate shipping date and will be invoiced with the price in effect at the date the purchase order is received. For current lead times, please review [www.nucraft.com/resources/lead-times](http://www.nucraft.com/resources/lead-times).

Shipping charges are prepaid (within the continental U.S.). Therefore, pricing is a delivered price based on normal ground transportation. If you have special instructions, need to ship by air, or are shipping to Alaska or Hawaii, contact Nucraft Customer Service. Nucraft can also help arrange to have products blanket wrapped for an additional charge. Contact the Nucraft Customer Service team or specify it on your purchase order.

**Minimum Freight Charge: Any order below \$3,000 net will be assessed a \$500 net minimum freight charge (one per order).**

Orders are subject to acquiring the materials required for manufacturing. Fulfillment can be affected by strikes, fires, embargoes and acts of government. These elements are beyond our control.

Nucraft offers a variety of services to accommodate a wide range of delivery requirements. Availability of these services is dependent on a number of factors and may not be offered with all shipments. Examples of delivery services that have additional fees include:

- Specific date
- Specific time of day, morning or afternoon
- Delivery to a warehouse before delivery to its final destination (unless product is picked up at the warehouse)

Contact the Nucraft Customer Service team for availability and pricing on these services.

## Freight Terms

Shipping charges for Nucraft products are prepaid for standard delivery in the continental United States. Standard delivery is defined as follows: Product is delivered on a 53' trailer being pulled by a long-haul tractor (total length of 85'). Facility will receive delivery Monday through Friday between the hours of 8:00 AM and 4:00 PM. Facility has docks with levelers and a fork truck for unloading. Product will be loaded on load bars two levels high. Receiving facility is responsible to have personnel on hand to unload the truck upon arrival, drivers do not unload. Delivery sites or times that do not meet these criteria may be accommodated, but will incur a charge to cover additional shipping costs. Please **notify Nucraft a minimum of two weeks prior to shipment** to arrange special services and determine additional charges.

## Storage

Nucraft has no storage facilities for finished product. If a customer cannot accept an order when it is ready for shipment, the customer must designate an alternative shipping address. If no address is provided, Nucraft may, at its discretion, transfer the product to storage. If product is transferred to an off-site storage facility, the customer may be charged for transportation to the facility and for any associated storage fees. Nucraft considers transfer of the product to a storage facility the equivalent of shipment, including invoicing and payment. Customers assume the risk of damage or loss during storage.

## Transportation Times and Delays

Third party carriers that Nucraft contracts with will make reasonable efforts to accommodate requested delivery times and dates. Scheduled delivery appointments may, however, be delayed for a variety of reasons, including inclement weather, traffic, transportation equipment problems, and delays encountered at other delivery locations along the delivery route. Nucraft does not recommend scheduling activities that depend on the delivery appointment (for example, scheduling furniture installers to install furniture the day of the delivery appointment). Nucraft shall not be liable for any costs incurred as a result of a missed delivery appointment.

## Shipment Damage Claims

Legal title to merchandise passes to the buyer upon acceptance by the carrier. Inspect all cartons upon delivery. Details of visible damage should be noted on the delivery receipt. Do not destroy packaging, transport to site, or install product if damage is found upon inspection. Inspection of products should be completed upon delivery to the receiver. If visible damage is apparent, a claim should be filed immediately with Nucraft Customer Service. If visible damage is not apparent, sign the delivery receipt "No visible damage." This will allow recourse for a concealed damage claim. Concealed damage claims must be filed within 15 days of receipt, **prior to transporting or installing any product.**

Do not destroy packing materials until shipment has been inspected. If damage is found, proceed to file a claim with Nucraft Customer Service.

**Failure to make any claims against Nucraft within 15 days shall constitute acceptance of the merchandise and a waiver of any defects, errors or shortages discovered upon inspection.**

## Cancellations

Cancellations must be reviewed by our Customer Service team. Because we build your products to order, orders cannot be cancelled once processing has begun. Processing includes but is not limited to development of shop drawings and other engineering drawings. If cancellation is approved, a processing fee of 20-100% will be assessed based on the status of the order.

## Change Order Policy

Nucraft will make every attempt to honor any reasonable change request to product provided that the request is received prior to start of production. Change orders will be accepted only if the request is made in writing and received in time to make the change. Nucraft reserves the right to increase our acknowledged price and ship date if necessary to make the requested changes. Please submit any change order request to our Customer Service team. Nucraft will assess charges to the customer as stipulated in the following:

- Standard Orders: Change orders received prior to production will be charged \$400 net to cover administrative costs.
- Special Orders: Change orders received prior to production will be charged \$400 net to cover administrative costs. There may be additional costs associated with engineering labor required for the change order.
- Change orders received after production must be evaluated by Nucraft. If approved, the charge will be \$400 net plus any restocking charges accumulated. There may be additional costs associated with engineering and/or manufacturing labor, as well as material costs, required for the change order.



# GENERAL INFORMATION

## Repair Authorization

Prior written approval is required for repairs of merchandise charged to Nucraft. Failure to do so will result in customer funded repairs.

## Payment Terms

Deposits are required at the time of order due to the custom nature of our products. See information regarding Cancellations above.

Credit terms are available to qualified customers. Please contact AR@Nucraft.com to start the application process. Note that the credit application process requires a valid sales tax exemption or resale tax certificate, Form W-9, and three current trade references.

Credit Card Payments are accepted via web portal. Please contact AR@Nucraft.com for payment instructions. Note that a 2% convenience fee will be added for using this payment method and no early pay discounts are allowed on credit card payments.

## Warranty

Nucraft Furniture is warranted to be free from defects in materials and workmanship for a period of ten years of single shift use. Limitations include:

- Mechanical Devices such as latches, casters, and other moving components are warranted for five years of the date of original delivery.
- Height adjustable components are warranted for two years of the date of original delivery.
- The following are warranted for one year of the date of original delivery:
  - Textiles
  - Electrical Components
  - Refrigeration Units
  - Custom Products not described in Nucraft's Catalogue

This warranty is applicable only if furniture is properly installed and maintained in an office environment. This warranty extends only to products manufactured and sold in North America and only to original purchasers acquiring new Nucraft product through authorized dealers or approved sellers.

During this warranty period, Nucraft's sole obligation is to repair or replace, at Nucraft's discretion, products which prove to be defective during the warranty period.

This warranty does not cover:

- Damage caused by a carrier.
- Damage from user modification, misuse, abuse, accident, or negligence.
- Customer's Own Material (COM) specified by the customer that is not a standard product offering.
- Color, grain, or texture of wood and other covering material.

**Nucraft extends no other warranties, expressed or implied, including warranty of merchantability or fitness for a particular purpose. Nucraft shall not be liable for loss of time, inconvenience, commercial loss, incidental or consequential damages.**

## Environmental Statement

Nucraft is committed to supporting responsible environmental policies and practices in all that we do. We strive for sustainability, weighing our business decisions against the costs to the ecological, social and economic systems they affect.

Our products are manufactured to meet the credit requirements of the U.S. Green Building Council's LEED rating systems in one or more of the following categories:

- Recycled Content
- Certified Wood
- Low-Emitting Materials

## Computer Aided Planning

Nucraft products and pricing are available via CET and 2020 Worksheet, an AutoCAD®-based space planning tool.

2020 Worksheet is an integrated software system developed specifically for interior designers and facility planners to enhance workplace performance. This modern suite of applications works together seamlessly, in concert. Navigate catalogs, select products, design in plan view and 3D, assign options, create worksheets and build a project where you want, when you want. Take your pick. It's dynamic and interactive. Design projects are a work in progress. And now you can perform any of the many discrete tasks that go into a project any time, any place.

Product symbols (Revit, 2D and 3D) are available on the Nucraft website at [www.nucraft.com/resources/designer-tools/product-symbols](http://www.nucraft.com/resources/designer-tools/product-symbols).

## iSpec®

Nucraft offers a free online product configuration and specification service that saves you time and allows you to be creative while leaving the nuts and bolts to someone else. No specific software is required, nor is there any learning curve. This service applies to all Nucraft products. For additional information, visit [www.nucraft.com/resources/designer-tools/ispec](http://www.nucraft.com/resources/designer-tools/ispec).



# FINISH INFORMATION

## Surface Materials Palette

We crafted our materials palette using the same demanding standards that distinguish our furniture. Thoughtful design and attention to every detail elevate your possibilities.

Anchored by Nucraft veneers, unrivaled for clarity, quality, and depth of finish, our collection of surface materials comprises a sophisticated set of balanced elements that supports your design vision.

Some elements have their roots in Nucraft's rich heritage. Others are new materials and reflect current trends and taste. Together, they ensure that you're ready for today and positioned well for the future. Beautifully.

## Custom Finishes

Nucraft specializes in expert custom finish matching. For a nominal upcharge we can provide custom finishes, and we are frequently asked to match the finishes of other furniture manufacturers. For finishes that appear unusual to match or for customers directly requesting a sample, a finish sample will be sent for approval prior to entering the order.

Custom finishes requiring colored varnishes to create a painted look can only be applied to Maple veneer and require one extra week in addition to the standard lead time. Nucraft's standard black finish (G82) can be applied to all Nucraft standard veneers. Walnut is the standard black veneer. Other species must be specified when ordering.

Clear coat on a special veneer requires an approved sample.

Custom finishes carry a 10% upcharge per item, per finish, capped at \$2,200 List.

Custom finish upcharges are not applied to any item that is not wood. Example: casters, ganging connectors, power options..

## Treatments

**Note: Default veneer sheen will vary per finish and product. Default finish is bolded on pages vi-vii. If no direction is provided on incoming orders, default sheen will be selected. In addition, default veneer cut is noted in the price list. If no direction is provided on incoming orders, default cut will be selected.**

**Gloss:** Gloss is a durable finish that tends to nicely mask normal wear and leaves wood grain visible to the eye. It achieves a medium gloss open pore appearance (40 – 50 sheen range). Finish numbers preceded by the letter "G" indicate a Gloss finish.

**Matte:** Like Gloss, Matte is durable, tends to nicely mask normal wear and leaves wood grain visible to the eye. It achieves a low luster, open pore appearance (10 – 20 sheen range). Finish numbers preceded by the letter "M" indicate a Matte finish.

Since each veneer type responds differently to both types of treatment, all will have a distinctive look and feel when finished. For example, a Walnut veneer with a Gloss treatment will remain much more textured than a Cherry veneer with the same treatment.

## About the Wood

All Nucraft veneers are carefully selected for uniformity of color and grain. Still, wood is a natural substance and minor variations may occur due to its own uniqueness. Because of this, the furniture you receive may not be an exact match to our samples.

Nucraft takes great pride in our finish color consistency. However, wood is a natural product that will have color variation within a single piece of furniture, as well as from one piece to the next. Other factors also affect color over time, such as exposure to light (both intensity and duration). For example, lighter finishes cause more variation in colors over time.

In cases where a returning customer wants a precise match with existing furniture, we recommend sending a sample of the existing furniture finish. Please contact Nucraft Customer Service to determine an appropriate sample. This will ensure a finish match between old and new orders. This type of order is considered a control sample. There will be a 10% upcharge on an order of this type. Due to natural aging of veneers, natural finishes may vary.

## Care and Maintenance of Wood Finishes

Our finish material is a crystal clear, urethane acrylic blend. This type of finish may be repaired in the field by a qualified refinisher.

Nucraft recommends using a damp cloth to clean your fine wood furniture. Always wipe with the grain of the wood. Should your wood furniture require a more thorough cleaning, we recommend using a mild cleaner such as Joy dish soap or Murphy's oil soap, thoroughly diluted in water (one part soap to thirty parts water). Water will not damage Nucraft's finish, but it may leave surface spots when it dries. To avoid this, dry the surface with a soft cloth after it is cleaned. Marks that cannot be removed with the cleaning methods above may be able to be removed using naphtha, a mild degreasing solvent.

Caution: while the use of polishes that contain wax, petroleum solvents or silicones may immediately enhance the "shine" of a product, it may also eventually remove the fine original finish applied in our factory. Silicone on the surface of wood may also make it very difficult to respray or refinish.

All Nucraft furniture is inspected and polished before it leaves our factory. In some instances, the packing materials may imprint on the factory polish. Cleaning and polishing the furniture once it is unpacked will normally restore the furniture to its original beauty.

In some cases, the rubber support feet used on the bottom of common office equipment (teleconferencing phones, laptops, microphones, copiers, etc.) can create unsightly marks in the surface of wood tops, due to oxidation of the lacquer finish. We suggest these machines be placed on a protective type of padding, such as felt.

Wood will fade as a result of exposure to UV light. This is particularly prevalent with light finishes. If color changes due to fading are a concern for your application, the impact can be minimized by selecting medium to dark stains for your wood surfaces. Our top coat includes a UV inhibitor which makes the finishes less prone to fading.



# FINISH INFORMATION

## Laminates

Selected Formica®, Nevamar®, and Wilsonart® laminates are available on Training Tables, Conference Tables, Conference Room Furniture and select Occasional Tables. For standard laminate and wood pricing, refer to individual item pricing columns. It is important to note that wood grain laminates are unable to be grain matched over multi-piece table top applications.

## Non-Standard Laminates and Linoleums

To order a color other than those on our list (see pages vi-vii), refer to Nevamar or Formica standard grade, matte texture laminate offerings and Forbo Furniture Linoleums (excluding manufacturers' non-standard matte offering).

Nucraft can support other laminate and linoleum options beyond what can be found as standard options on pages vi-viii. For pricing, please send a request to quotes@nucraft.com.

## Care and Maintenance of Laminate and Novawrap

Laminate and Novawrap surfaces may be cleaned with a damp cloth and ordinary soap or non-abrasive household liquid detergent. Dry the surface with a clean cloth or soft paper towel to prevent streaks from appearing.

## Care and Maintenance of Metal

Metal surfaces can be wiped with a damp cloth and rubbed dry. A mild non-abrasive household liquid detergent can be used if necessary. Regular maintenance of metal components, including tightening of fasteners and light lubrication of moving parts, will extend the life of your furniture.

## Satin Etched Glass

Glass color may vary slightly on multi-piece conference table tops over 180" x 60" when satin etched glass is specified due to the iron content and etching process of the glass.

## Care and Maintenance of Glass

Clear or frosted glass may be cleaned with commercial glass cleaner. Be sure to use a lint-free cloth if cleaning the frosted side of the glass.

## Stone and Solid Surface Material

Despite its reputation for durability, natural stone can easily be broken during handling and/or installation if proper techniques are not followed. In addition, Nucraft is not responsible for the installation of natural stone or solid surface materials on its products. Therefore, installers specifically trained in the installation of these materials must be utilized to ensure a quality installation. Nucraft shall not be liable for any damages incurred during the handling and/or installation of natural stone or solid surface materials on its products.

## Care and Maintenance of Granite

Granite surfaces may be cleaned with a damp cloth and ordinary soap or non-abrasive household liquid detergent. Dry the surface with a clean cloth or soft paper towel to prevent streaks from appearing.

## Care and Maintenance of Leather

Genuine leather requires very little care. Nucraft recommends that leather be dusted regularly. If a more thorough cleaning is needed, use lukewarm water and a mild, non-abrasive soap. Generate some lather and lightly rub the surface with cheesecloth. Rinse off any soap film with clean water and towel dry. The leather may dry dull. To restore the leather to a normal gloss, rub it with a clean towel. Never use furniture polish, oil, varnish or ammonia. Saddle soap may be used to prevent the leather from becoming brittle or cracked and to maintain the original supple finish.

## Touch Up Finish Kits

Model #	Description	Price
KIT-M	Metal Kit	85
KIT-P	Paint Kit	85
KIT-S	Stain Kit	85

### REQUIRED INFORMATION: (ORDER CANNOT BE ENTERED WITHOUT THIS INFORMATION)

- Kit model number
- Quantity of kits
- Specify finish (See pages vi-vii)

### General Information:

- Touch-up kits must be ordered on a purchase order separate from Nucraft product due to Hazmat shipping

### Retrofit & Replacements

If needing a partial placement or retrofit solution, please reach out to our quote team. Grain/color matched in a set.



## VENEER

### STANDARD

Default veneer sheen will vary per finish and were determined by a team of experts who reviewed the colorways to determine if gloss or matte best highlighted the natural characteristics of the species of wood and the color of the stain. Default finish is bolded. If no direction is provided, default sheen will be selected.

	Matte	Gloss
<b>Rift Cut Oak</b>		
Carbon	M03	<b>G03</b>

### Flat Cut Oak

Artisan	<b>M68</b>	G68
Coco	<b>M67</b>	G67
Dove	<b>M66</b>	G66
Dune	<b>M05</b>	G05
Midnight	<b>M69</b>	G69
Portobello	<b>M7413</b>	G7413
Winter	<b>M70</b>	G70

### Flaky Oak

Sahara	<b>M61</b>	G61
--------	------------	-----

### Cherry

Auburn	M93	<b>G93</b>
Cognac	M21	<b>G21</b>

### Walnut

Marron	<b>M35</b>	G35
Mocha	<b>M33</b>	G33
Onyx	M82	<b>G82</b>
Otter	M31	<b>G31</b>
Zinc	M30	<b>G30</b>

### Maple

Natural Maple	M60	<b>G60</b>
---------------	-----	------------

### Linea

Euro Birch Linea	<b>M09</b>	G09
Oak Linea	<b>M08</b>	G08
Silver Birch Linea	M10	<b>G10</b>
Walnut Linea	<b>M27</b>	G27

### Paldao

Canyon	M77	<b>G77</b>
Paldao	<b>M76</b>	G76
Thicket	<b>M75</b>	G75

## LAMINATE

Coordinating wood finish and edgeband options listed below.

		Solid Edge Band
<b>Solid Laminates</b>		
Formica Brite White	459-58	R01
Formica Dover White	7197-58	R01
Formica Folkstone	927-58	R03
Formica Graphite	837-58	R05
Formica Graystone	464-58	R02
Formica Pearl	934-58	R02

### Patterned Laminates

Nevamar Calm Distinction	VA6001T	R05
Nevamar Cool Chic	VA7002T	R02
Nevamar Easy Elegance	VA5002T	R05
Nevamar Serene Stardom	VA5001T	R05
Wilsonart Sheer Mesh	4876-38	R02
Wilsonart Grey Mesh	4877-38	R02
Wilsonart Pewter Mesh	4878-38	R05

		Wood Finish	Woodgrain Edge Band
<b>Wood Grain Laminates</b>			
Formica Aged Ash	8844-58	M8844	R8844
Formica Blackened Legno	8848-58	M8848	R8848
Formica Bleached Legno	8845-58	M8845	R8845
Formica Chestnut Woodline	5884-58	M5884	R5884
Formica Espresso Pear	5489-58	M5489	R5489
Formica Natural Ash	8843-58	M8843	R8843
Formica Oiled Legno	8846-58	M8846	R8846
Formica Pecan Woodline	5883-58	M5883	R5883
Formica Planked Coffee Oak	7413-58	M7413	F7413
Formica Sand Maple	9237-58	G60	W7909
Formica Smoky Brown Pear	5488-58	M5488	R5488
Formica Thermo Walnut	6402-58	M6402	R6402
Formica Urban Planked Oak	9312-58	M9312	R9312
Formica Weathered Ash	8842-58	M8842	R8842
Formica White Ash	8841-58	M8841	R8841

## GLASS\*

	Satin	Gloss
<b>Satin or Gloss Glass</b>		
Black	BS	-
Clove	VS	VG
Meringue	MS	MG
Moonlight	MLS	MLG
Storm	STS	STG
Quill	QS	QG
White	WS	WG

\*Available on Power Matrix only.



## METAL

---

### Powder Coat

Aged Bronze	A8010
Black	A44
Burnished	A8009
Cloud	A8004
Foil	A8006
Galaxy	A8007
Moonlight	A87
Satin Bronze	A8011
Shadow	A8005
Storm	A8012

### Metal

Clear Anodized*	CA
Polished Chrome (upcharge applies)	PC

\*Available on Grommet and Power Matrix only.

## PAINT

---

Aged Bronze	S8010
Black	S44
Burnished	S88
Cloud	S8004
Foil	S8006
Galaxy	S8007
Moonlight	S87
Satin Bronze	S8011
Shadow	S8005
Storm	S8012

### Paint to Match

To request a custom paint color, contact Nucraft Customer Service.  
A paint sample must be matched and approved prior to order.

## EDGE BAND

---

Ashen	R04
Parchment	R02
Shale	R05
Stone	R03
Whitecap	R01