

ALEV™ MEETING

Planning Guide + Price List

QUICK LINKS

[PLANNING GUIDE](#)

[ALEV PRICING](#)

[POWER AND DATA OPTIONS](#)

[GENERAL INFORMATION](#)

[FINISH INFORMATION](#)

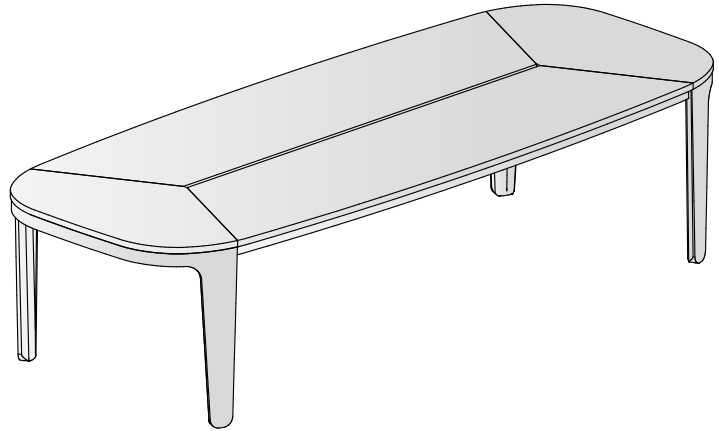
[SURFACE MATERIALS](#)



TABLE OF CONTENTS

Click the shortcuts below to jump to each section.

General Information	ii-iii
Finish Information	iv-v
Surface Materials	vi-vii
Statement of Line	3
Specification Overview	4
Planning Guide	5
Price List	
Segmented Tables	26
Classic Tables	27
Power and Data Options	28-34

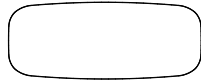
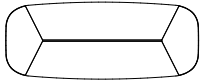




STATEMENT OF LINE

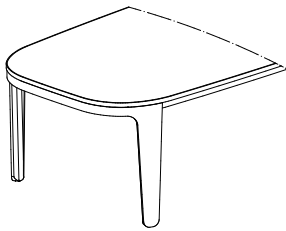
TABLE TOPS

Pages 26-27



BASES

Pages 26-27





SPECIFICATION OVERVIEW

1. Select the Top Style

Alev Meeting table tops are available in two types:
Segmented and Classic.

2. Select the Top Size and Finish

Table sizes: 84" to 240" long and 42" to 60" wide.

3. Select Power Option (if desired)

Table Top Options: Sliding USB is available on Segmented tops only. Power Cap, Tech Node, and Power Matrix Small or Medium are available on Classic tops only.

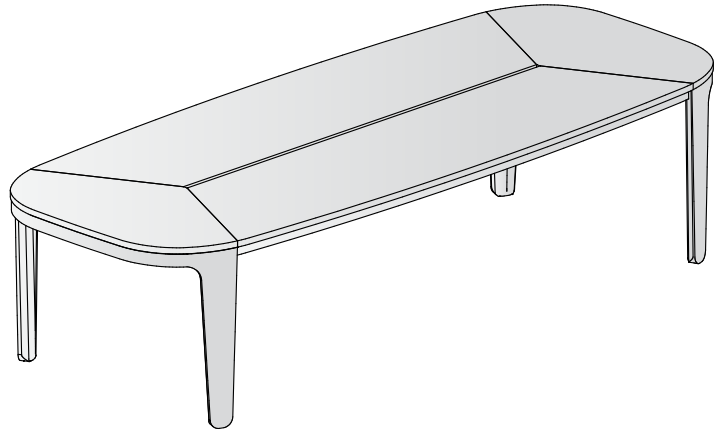
Under Surface Options: Low Profile Perimeter Power which is housed in the metal rail that runs the lengths of the table.



DETAIL OVERVIEW

ALEV MEETING TABLE

Whether in a community setting or formal meeting space, Alev Meeting fits any need, any space, or any design. The table design appears understated at first glance, but on closer review, the details are highly complex and thoughtfully developed. Seamlessly crafted hardwood legs are positioned to be celebrated even once chairs surround the table. An intricate veneer layup is featured on the Segmented table top. Sliding USB integrates into the open channel of the Segmented top and Low Profile Perimeter Power fits into the metal apron that runs the lengths of the table.





GRAIN DIRECTION

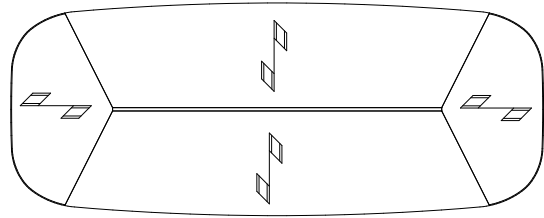
Nucraft takes great pride in providing our customers with the best quality veneers available. However, wood is a natural material and, as such, is prone to natural color and grain variations.

Grain direction on segmented tops runs the width of the table on the center pieces, with the end pieces running the length of the table. The changes in grain direction are intentional for the design of the table and will create color variation (sometimes referred to as "flip"). This is an effect

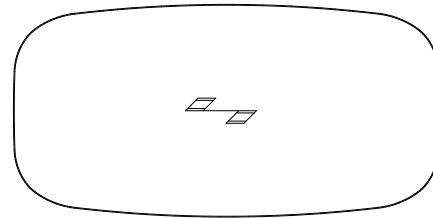
produced by wood where two very similar pieces appear to be different (one lighter, one darker) based on viewing angle (and intentional grain placement as shown in this design) when the grain on each top is not running in a parallel direction relative to each other. As the viewing angle changes, the color of the wood appears to change ("flip") with the lighter one becoming darker and vice versa.

Grain direction on classic tops runs the length of the table up to 96" long. On tables longer than 96" the grain direction runs the width of the table.

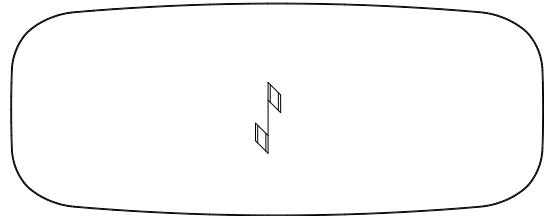
Segmented Tops



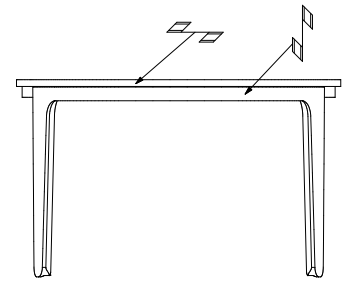
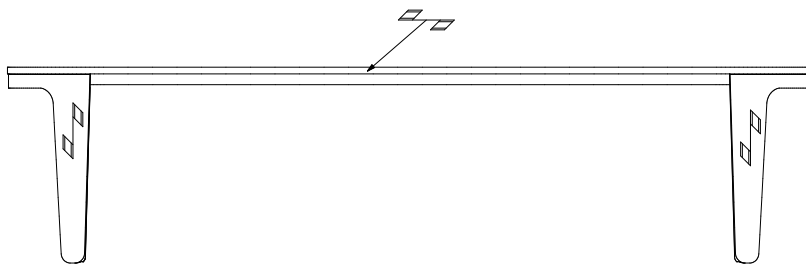
Classic Tops 96" and Shorter



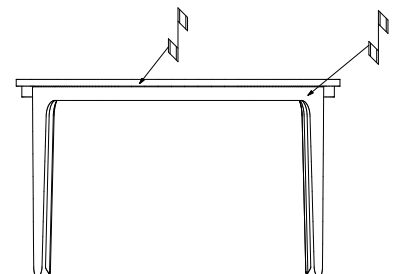
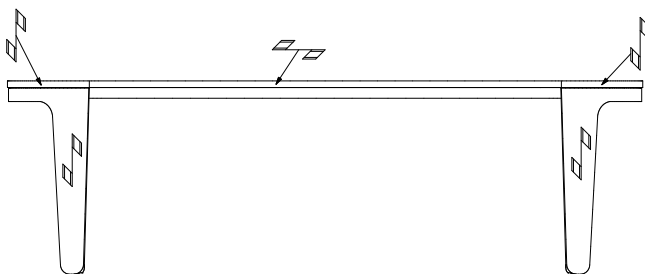
Classic Tops Longer Than 96"



Classic Top Tables



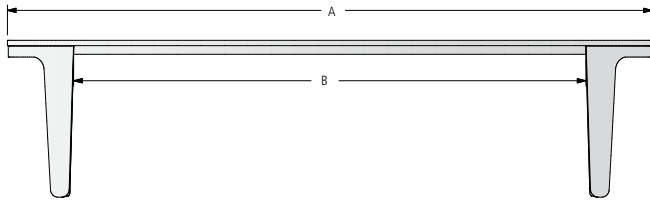
Segmented Top Tables





MAXIMUM SEATING CAPACITY

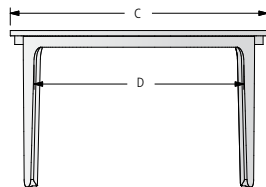
Note: Seating capacity is based on 27" per person.



WIDTH

LENGTH	42"	48"	54"	60"
84"	6	6	-	-
90"	6	6	-	-
96"	6	6	-	-
102"	6	6	-	-
108"	8	8	8	-
114"	8	8	8	-
120"	8	8	8	-
132"	-	8	8	-
144"	-	10	10	-
156"	-	10	10	10
168"	-	12	12	12
180"	-	-	12	12
192"	-	-	14	14
204"	-	-	14	14
216"	-	-	16	16
228"	-	-	16	16
240"	-	-	18	18

A	B			
	42"	48"	54"	60"
84"	59.25"	59.25"	-	-
90"	65.25"	65.25"	-	-
96"	71.25"	71.25"	-	-
102"	77.25"	77.25"	-	-
108"	83.25"	83.25"	84.25"	84.25"
114"	89.25"	89.25"	90.25"	90.25"
120"	95.25"	95.25"	96.25"	96.25"
132"	-	107.25"	108.25"	108.25"
144"	-	119.25"	120.25"	120.25"
156"	-	131.25"	132.25"	132.25"
168"	-	-	144.25"	144.25"
180"	-	-	156.25"	156.26"
192"	-	-	168.25"	168.25"
204"	-	-	180.25"	180.25"
216"	-	-	192.25"	192.25"
228"	-	-	204.25"	204.25"
240"	-	-	216.25"	216.25"

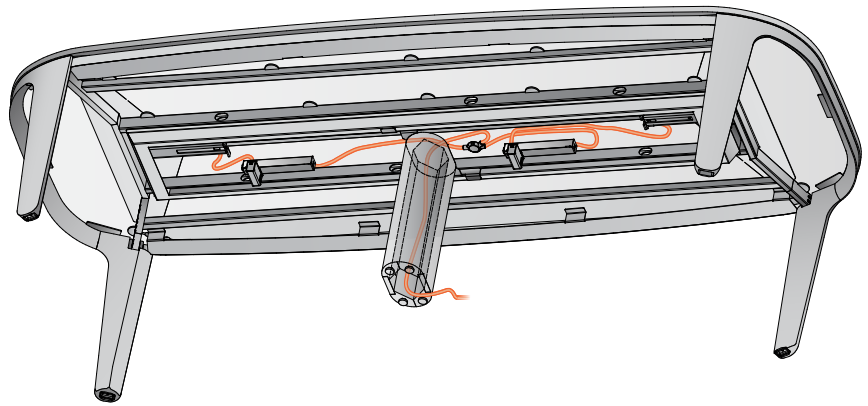


C	D
42"	31.00"
47"	36.75"
54"	42.50"
60"	48.00"

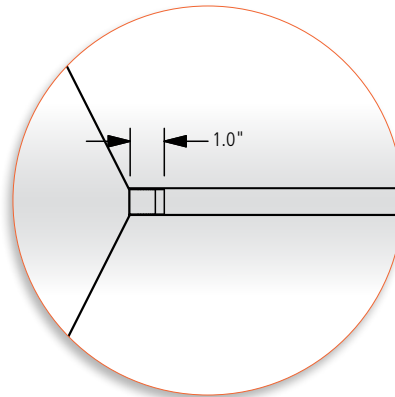


TABLETOP POWER OPTION: SLIDING USB

A unique feature of the table is a long 3/4"-wide channel down the center of the table that cuts through the perpendicular veneer grain pattern. Cleverly concealed, the sliding USB end units pull open 6" to reveal USB power access. When not in use, just slide the unit back to hide it. On a table with a center USB unit, it will be static. Sliding USB end units are 14.75" from each end of the table. Each Sliding USB unit includes (3) USB-A and (1) USB-C connectors.



Sliding USB - Closed



Sliding USB - Open

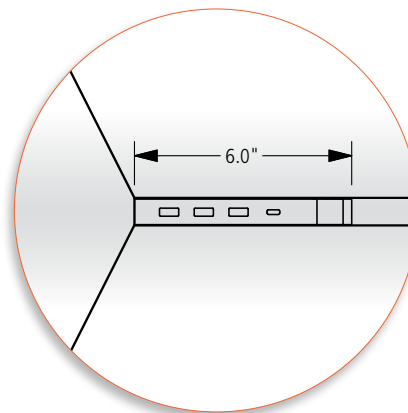




TABLE TOP POWER OPTION: POWER CAP

For table top access, Power Cap is offered in three configurations and four locations; center, on either end, three equally spaced, or four equally spaced. Locations are based on table length.

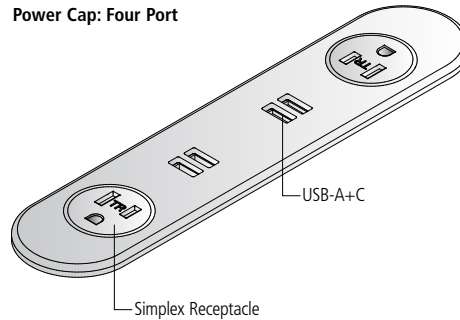
POWER

Where more power is desired and AV connectivity is not required, the standard configuration includes two simplex receptacles and two USB-A+C chargers.

DATA/AV FACEPLATES

Power Cap can be specified with two Extron Architectural Adaptor Plates (AAPs) for unparalleled flexibility in data and AV connectivity. Optional faceplates provide a wide range of AV connectivity choices.

Power Cap: Four Port



DESIGN

Power Cap's sleek profile is available in powder coat and polished chrome finish options. Braided direct plugin infeed cord with optional hardwire infeed available.

PERFORMANCE

Intended for high use and quick access, Power Cap's low-profile aesthetic is non-lidded for ample space for plug-heads of all sizes.

STANDARD CONFIGURATIONS

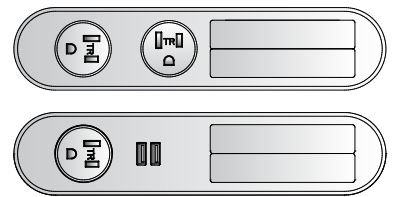
Power Cap is offered in three configurations:

- Two simplex receptacles and two USB-A+C chargers
- One Simplex, one USB-A+C charger, and two single space Extron Architectural Adapter Plates (AAP's)
- Two Simplex receptacles and two single space Extron Architectural Adapter Plates (AAP's)

Four Port Default Configuration



Four Port Optional Configurations



DIMENSIONS

- Four Port Power Cap: 2" x 9"
- Power Caps are 3/16" in height



TABLE TOP POWER OPTION: POWER CAP

POWER PLANNING

Power Cap is available with two options for connection with building power:

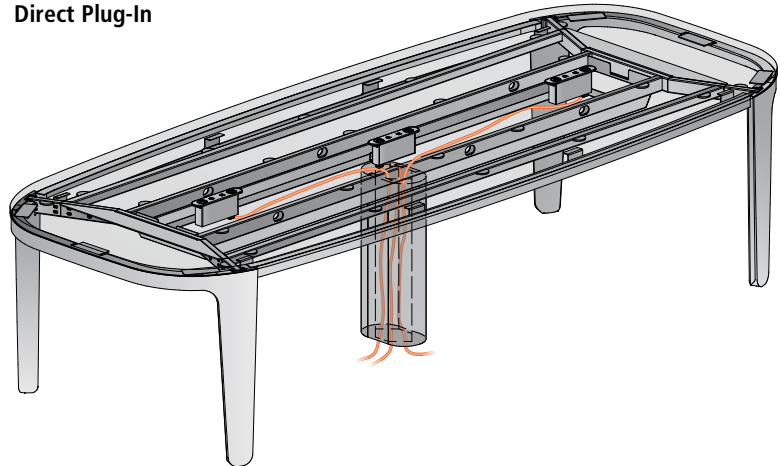
DIRECT PLUG-IN

The 15-amp power cord from each Power Cap unit is plugged into a floor monument. The floor monument must have at least one power outlet per Power Cap unit in the table (e.g., a table with four Power Cap units would need four power outlets in the floor monument).

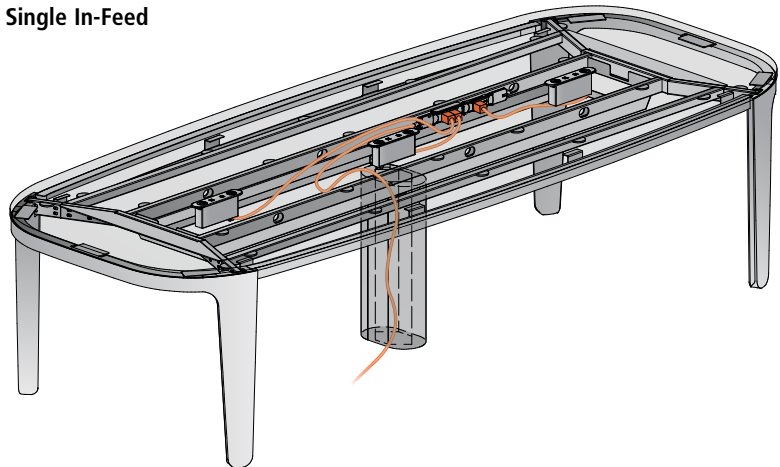
SINGLE IN-FEED

Each Power Cap unit is plugged into a two-circuit modular electrical system in the table from which a single connection is made to a floor monument. This connection can be either hardwired (to utilize both of the circuits in the modular electrical system) or corded (which requires a 20-amp power outlet in the floor monument and reduces the modular electrical system in the table to a single circuit).

Direct Plug-In



Single In-Feed



Two-Circuit Modular Electrical System

- 4-wire, 20-amp, 2-circuit modular electrical system.
- Only present on tables specified with the Single In-Feed option.
- Hardwire or corded (20-amp) in-feed options. A licensed electrician is required to complete hardwire connections to building's power source.
- Neutral (white) wires are 10 gauge, hot and ground wires are 12 gauge.
- All electrical components satisfy National Electrical Code (NEC) requirements and are UL listed

Electrical Diagram — Hardwire Power Infeed Only

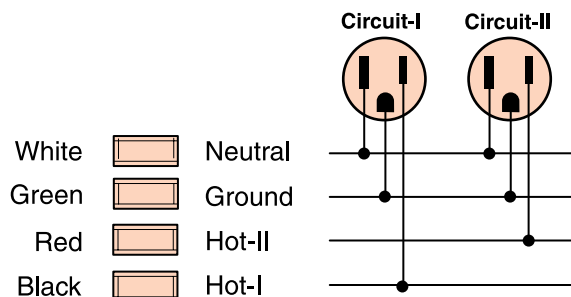
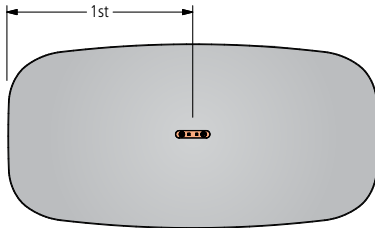




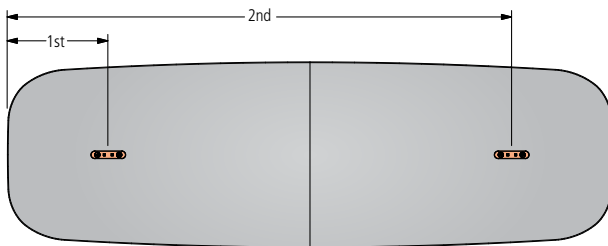
TABLE TOP POWER OPTION: POWER CAP

POWER CAP LOCATION OPTIONS



POWER CAP AT CENTER

Length	Center of Power Cap
84	42
90	45
96	48
102	51
108	54
114	57
120	60

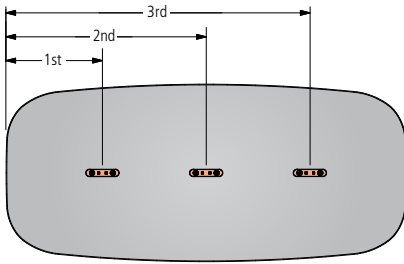


POWER CAP AT EACH END

Length	Center of 1st Power Cap	Center of 2nd Power Cap
84	26	58
90	26	64
96	26	70
102	26	76
108	26	82
114	26	88
120	26	94
132	26	106
144	26	118
156	26	130
168	26	142
180	26	154
192	26	166
204	26	178
216	26	190
228	26	202
240	26	214

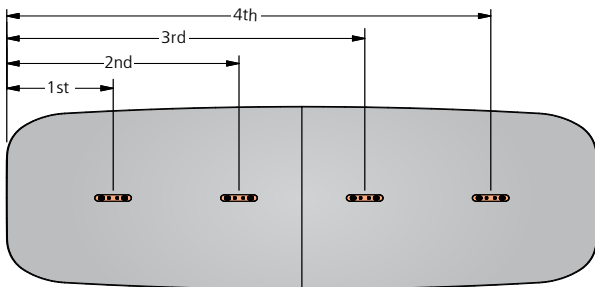


TABLE TOP POWER OPTION: POWER CAP



POWER IN CENTER AND AT EACH END

Length	Center of 1st Power Unit	Center of 2nd Power Unit	Center of 3rd Power Unit
96	26	48	70
102	26	51	76
108	26	54	82
114	26	57	88
120	26	60	94
132	26	66	106
144	26	72	118
156	26	78	130
168	26	84	142
180	26	90	154
192	26	96	166
204	26	102	178
216	26	108	190
228	26	114	202
240	26	120	214



FOUR POWER UNITS EQUALLY SPACED

Length	Center of 1st Power Unit	Center of 2nd Power Unit	Center of 3rd Power Unit	Center of 4th Power Unit
132	26	53	79	106
144	26	57	87	118
156	26	61	95	130
168	26	65	103	142
180	26	69	111	154
192	26	73	119	166
204	26	77	127	178
216	26	81	135	190
228	26	85	143	202
240	26	89	151	214

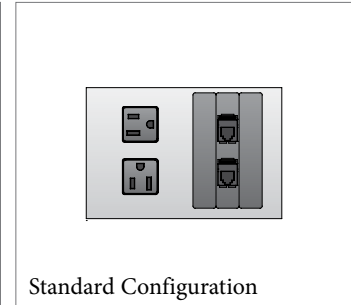
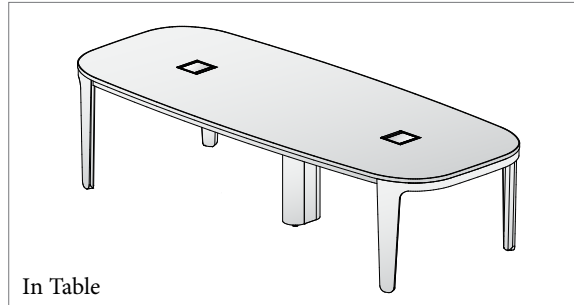


TABLE TOP POWER OPTION: POWER MATRIX

Available in small or medium sizes with a variety of styles and connectivity options, Power Matrix is Nucraft's most versatile power option. Power Matrix incorporates a broad array of scalable features and is available across multiple product lines, making it the "go to" solution for power and AV connectivity needs.

Offered in small or medium sizes and two door configurations (single and double), Power Matrix can handle any power and AV connectivity need, from the simplest to the most demanding.

Small



Medium

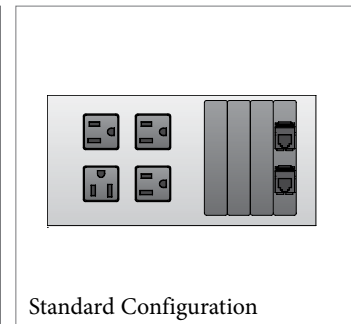
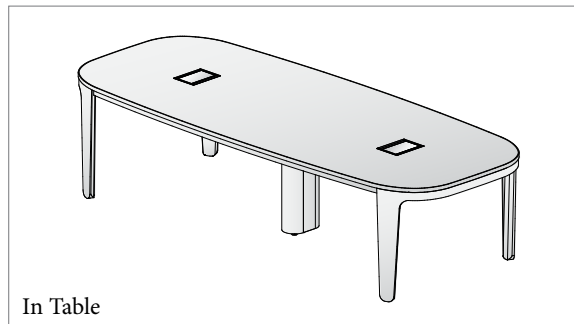
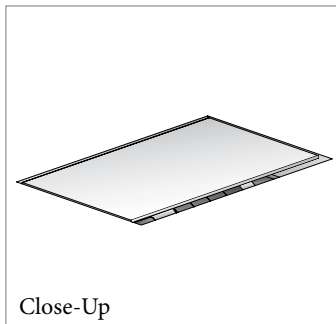




TABLE TOP POWER OPTION: POWER MATRIX

Power Matrix is filled with a broad array of high performance features and refined aesthetic elements.

POWER

Power Matrix features simplex receptacles for power connectivity, the quantity of which is pre-determined based on the size of the unit. An optional USB-A+C charger can also be specified in place of one of the simplex receptacles when desired. Corded or hardwired in-feed options add flexibility.

DATA/AV FACEPLATES

Power Matrix accommodates Extron Architectural Adaptor Plates (AAPs) for unparalleled flexibility in data and AV connectivity.

DESIGN

Power Matrix units feature a clear anodized aluminum body and a bezel-free flush mount design on wood tables for an elegant appearance.

PERFORMANCE

Friction hinges ensure smooth travel through the door's range of motion and can hold the door in any position. Hidden door stops maintain the minimalist aesthetic. Cable storage is both concealed and ample.

DOORS

Power Matrix is offered in multiple door material options, including metal, glass and grain-matched wood cut from the same table top.

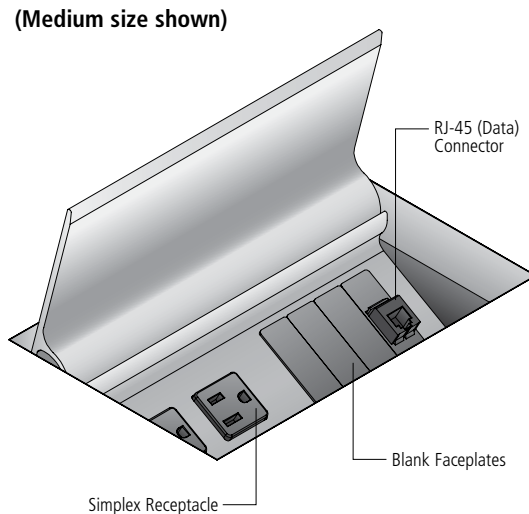




TABLE TOP POWER OPTION: POWER MATRIX

STANDARD CONFIGURATIONS

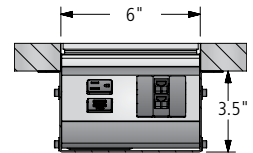
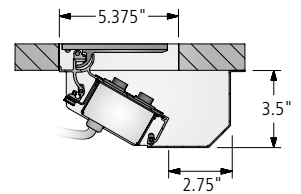
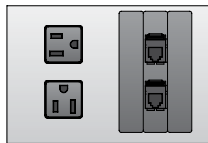
Power Matrix is offered in small or medium sizes, each with a pre-determined quantity of simplex outlets and AV faceplates. With each size, an optional 2 amp USB-A+C charger (1 amp per port) replaces one of the simplex outlets.

Each Power Matrix unit includes a low-profile pan beneath the work surface to conceal the unit and provide ample storage capacity for excess cables. The size of the cutout in the table top varies with each size of Power Matrix unit.

SMALL

- Single door design
- 5.375" x 6" cutout
- Two simplex outlets
- Three AV faceplates. Standard configuration includes two blank faceplates & one faceplate with two RJ-45 (data) connectors.
- (1) 12' plug-in infeed cord

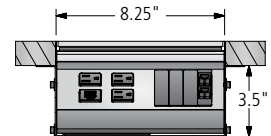
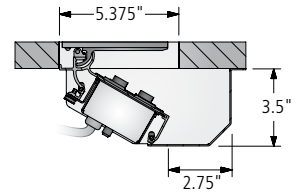
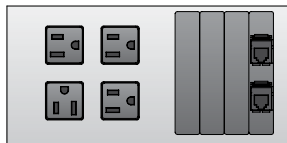
Power Matrix Small



MEDIUM

- Single door design
- 5.375" x 8.25" cutout
- Four simplex outlets
- Four AV faceplates. Standard configuration includes three blank faceplates & one faceplate with two RJ-45 (data) connectors.
- (1) 12' plug-in infeed cord

Power Matrix Medium



FIELD-WIRED

Some local electrical codes may require field-wiring during installation. In such instances, a Field-Wired option may be specified. In this configuration, each Power Matrix unit will be supplied with a 6' flexible metal conduit with hot, ground and neutral wires.





TABLE TOP POWER OPTION: POWER MATRIX

LOCATION CODES

Power Matrix is offered in a variety of locations and quantities per table size, offering a broad range of performance and pricing options.

POWER MATRIX SMALL	POWER MATRIX MEDIUM	LOCATION	QUANTITY OF UNITS TO ORDER
PS-1	PM-1	One at center	1
PS-2	PM-2	One at each end	2
PS-3	PM-3	One at center and one at each end	3
PS-4	PM-4	Four equally spaced (tables 132" and longer)	4

DOOR MATERIAL AND LOCATION AVAILABILITY BY TABLE SIZE

W = Wood Door G = Glass Door M = Metal Door

LENGTH	TOP SECTIONS	POWER MATRIX SMALL				POWER MATRIX MEDIUM			
		PS-1	PS-2	PS-3	PS-4	PM-1	PM-2	PM-3	PM-4
72	1	W/G/M	W/G/M	-	-	W/G/M	W/G/M	-	-
78	1	W/G/M	W/G/M	-	-	W/G/M	W/G/M	-	-
84	1	W/G/M	W/G/M	-	-	W/G/M	W/G/M	-	-
90	1	W/G/M	W/G/M	-	-	W/G/M	W/G/M	-	-
96	1	W/G/M	W/G/M	W/G/M	-	W/G/M	W/G/M	W/G/M	-
102	1	W/G/M	W/G/M	W/G/M	-	W/G/M	W/G/M	W/G/M	-
102	2	-	W/G/M	-	-	-	W/G/M	-	-
108	1	W/G/M	W/G/M	W/G/M	-	W/G/M	W/G/M	W/G/M	-
108	2	-	W/G/M	-	-	-	W/G/M	-	-
114	1	W/G/M	W/G/M	W/G/M	-	W/G/M	W/G/M	W/G/M	-
114	2	-	W/G/M	-	-	-	W/G/M	-	-
120	1	W/G/M	W/G/M	W/G/M	-	W/G/M	W/G/M	W/G/M	-
120	2	-	W/G/M	-	-	-	W/G/M	-	-
132	2	-	W/G/M	-	W/G/M	-	W/G/M	-	W/G/M
144	2	-	W/G/M	-	W/G/M	-	W/G/M	-	W/G/M
156	2	-	W/G/M	-	W/G/M	-	W/G/M	-	W/G/M
168	2	-	W/G/M	-	W/G/M	-	W/G/M	-	W/G/M
180	2	-	W/G/M	-	W/G/M	-	W/G/M	-	W/G/M
192	2	-	W/G/M	-	W/G/M	-	W/G/M	-	W/G/M
192	4	-	W/G/M	-	W/G/M	-	W/G/M	-	W/G/M
204	2	-	W/G/M	-	W/G/M	-	W/G/M	-	W/G/M
204	4	-	W/G/M	-	W/G/M	-	W/G/M	-	W/G/M
216	2	-	W/G/M	-	W/G/M	-	W/G/M	-	W/G/M
216	4	-	W/G/M	-	W/G/M	-	W/G/M	-	W/G/M
228	2	-	W/G/M	-	W/G/M	-	W/G/M	-	W/G/M
228	4	-	W/G/M	-	W/G/M	-	W/G/M	-	W/G/M
240	2	-	W/G/M	-	W/G/M	-	W/G/M	-	W/G/M
240	4	-	W/G/M	-	W/G/M	-	W/G/M	-	W/G/M



TABLE TOP POWER OPTION: POWER MATRIX

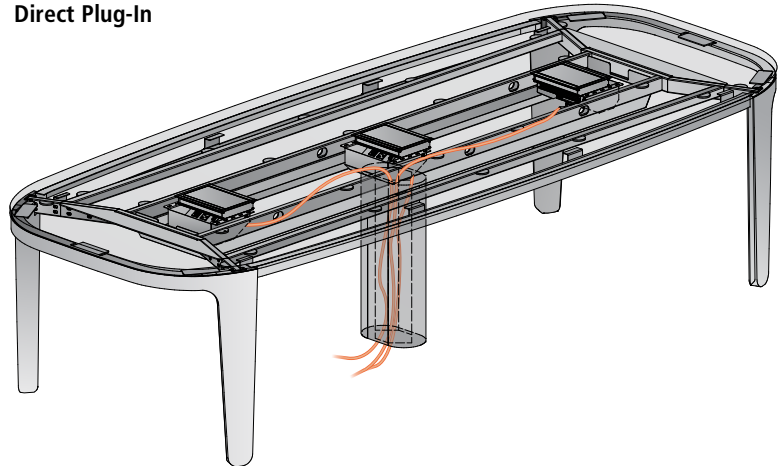
POWER PLANNING

Power Matrix is available with two options for connection with building power:

DIRECT PLUG-IN

The 15-amp power cord from each Power Matrix unit is plugged into a floor monument. The floor monument must have at least one power outlet per small or medium Power Matrix unit in the table (e.g., a table with four small or medium Power Matrix units would need four power outlets in the floor monument).

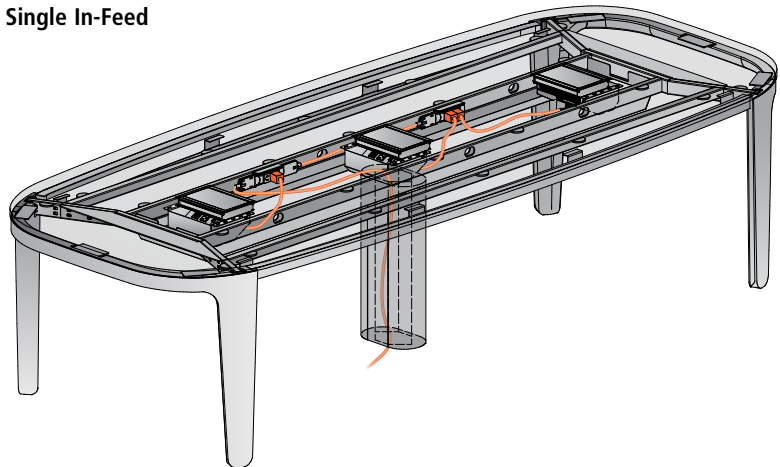
Direct Plug-In



SINGLE IN-FEED

Each Power Matrix unit is plugged into a two-circuit modular electrical system in the table from which a single connection is made to a floor monument. This connection can be either hardwired (to utilize both of the circuits in the modular electrical system) or corded (which requires a 20-amp power outlet in the floor monument and reduces the modular electrical system in the table to a single circuit).

Single In-Feed



Two-Circuit Modular Electrical System

- 4-wire, 20-amp, 2-circuit modular electrical system.
- Only present on tables specified with the Single In-Feed option.
- Hardwire or corded (20-amp) in-feed options. A licensed electrician is required to complete hardwire connections to building's power source.
- Neutral (white) wires are 10 gauge, hot and ground wires are 12 gauge.
- All electrical components satisfy National Electrical Code (NEC) requirements and are UL listed

Electrical Diagram — Hardwire Power Infeed Only

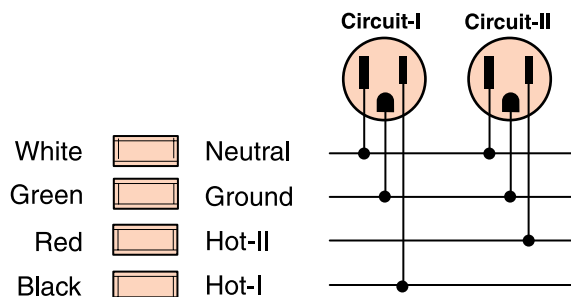
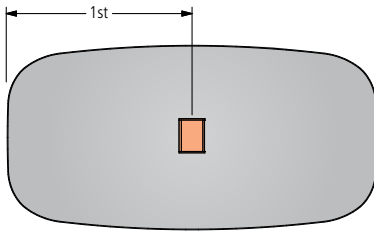




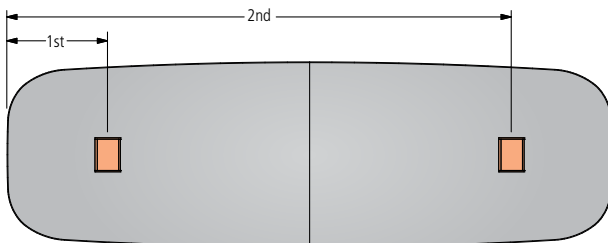
TABLE TOP POWER OPTION: POWER MATRIX

POWER MATRIX SMALL OR MEDIUM LOCATION OPTIONS



PS-1 or PM-1

PS-1 or PM-1	
Length	Center of Power Matrix
84	42
90	45
96	48
102	51
108	54
114	57
120	60



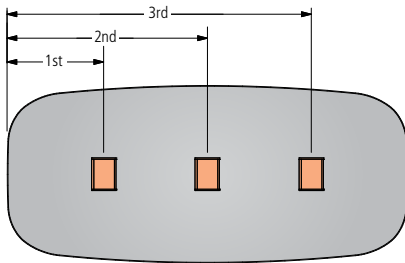
PS-2 or PM-2

PS-2 or PM-2		
Length	Center of 1st Power Matrix	Center of 2nd Power Matrix
84	26	58
90	26	64
96	26	70
102	26	76
108	26	82
114	26	88
120	26	94
132	26	106
144	26	118
156	26	130
168	26	142
180	26	154
192	26	166
204	26	178
216	26	190
228	26	202
240	26	214



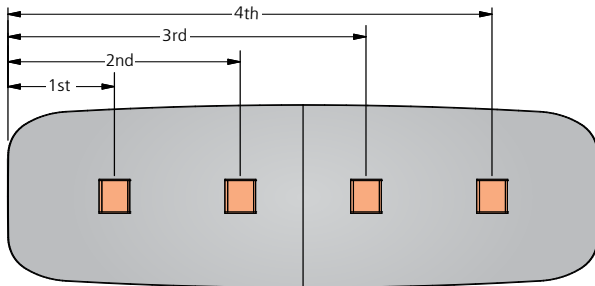
TABLE TOP POWER OPTION: POWER MATRIX

POWER MATRIX SMALL OR MEDIUM LOCATION OPTIONS



PS-3 or PM-3

PS-3 or PM-3			
Length	Center of 1st Power Matrix	Center of 2nd Power Matrix	Center of 3rd Power Matrix
96	26	48	70
102	26	51	76
108	26	54	82
114	26	57	88
120	26	60	94



PS-4 or PM-4

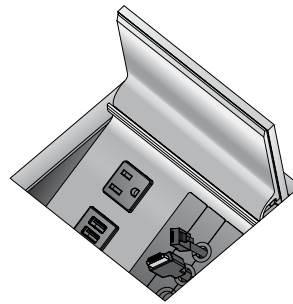
PS-4 or PM-4				
Length	Center of 1st Power Matrix	Center of 2nd Power Matrix	Center of 3rd Power Matrix	Center of 4th Power Matrix
132	26	53	79	106
144	26	57	87	118
156	26	61	95	130
168	26	65	103	142
180	26	69	111	154
192	26	73	119	166
204	26	77	127	178
216	26	81	135	190
228	26	85	143	202
240	26	89	151	214



TABLE TOP POWER OPTION: POWER MATRIX

RETRACTORS

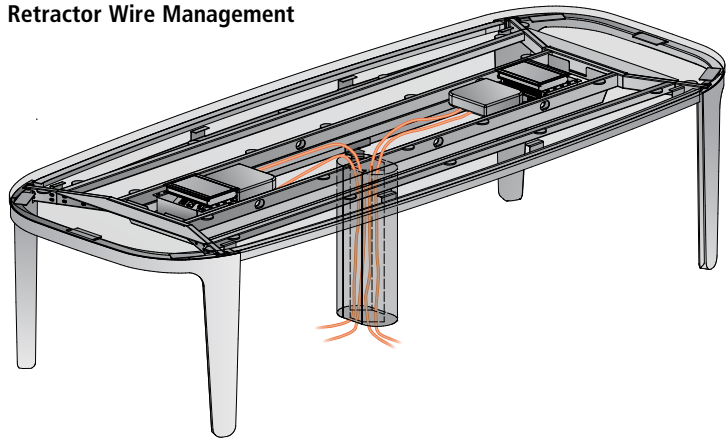
Cable retractors, for use with Power Matrix Small and Medium only, mount directly to the underside of conference room tables using the included mounting bracket. Loaded with 12' of cable that extends out 5' from the retractor. Retractors have a female input from the building infrastructure and a male connector on the output side.



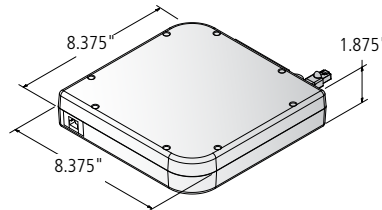
Retractor Availability on Alev Tables
X = Available as Standard

Length	PS-1/ PM-1	PS-2/ PM-2	PS-3/ PM-3	PS-4/ PM-4
84	X	X		
90	X	X		
96	X	X		
102	X	X		
108	X	X		
114	X	X	X	
120	X	X	X	
132		X		
144		X		X
156		X		X
168		X		X
180		X		X
192		X		X
204		X		X
216		X		X
228		X		X
240		X		X

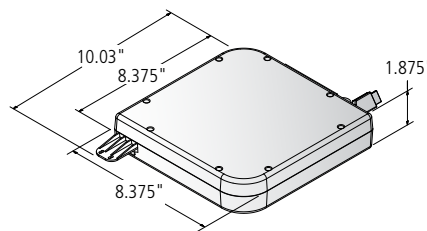
Retractor Wire Management



CAT6 Retractor



HDMI Retractor



Data USB Retractor

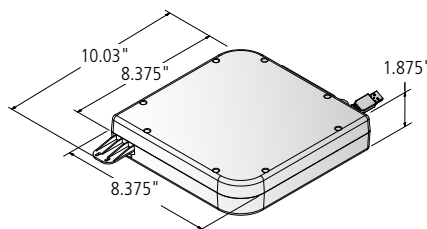




TABLE TOP POWER OPTION: TECH NODE

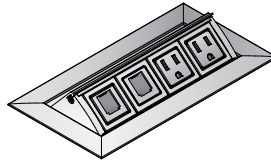
Tech Node offers convenient access to power and voice/data connections. Tech Node features include a push/push open design that conceals internal components.

Tech Node components:

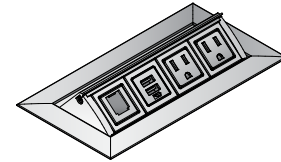
- Clear or Black Anodized Aluminum
- Fluid one touch accessibility
- Two (2) Simplexes
- Up to two voice/data ports
- 2' 15-Amp cord
- Voice/Data Adapter Kit p/n BE01421 to accept couplers & jacks
- UL Listed
- Overall dimensions - 4-7/16" x 8-5/16"
- Optional powered USB-A+C

All electrical components are UL listed.

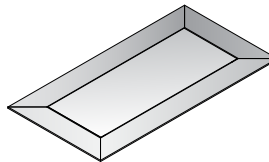
Tech Node - Cover Open



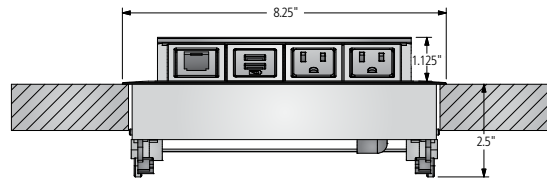
Tech Node - Cover Open with Optional USB-A+C



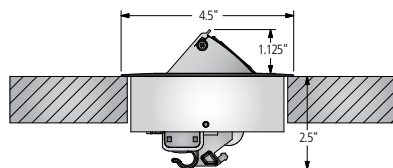
Tech Node - Cover Closed



Tech Node - Open Front View



Tech Node - Open Side View



VOICE/DATA PLANNING

Two (2) simplex voice/data cutouts accept customer supplied, field-installed snap-in connectors.

Nucraft recommends consulting an audio/visual (AV) integrator for assistance with voice/data planning.

Voice/Data Product Manufacturers

Manufacturer	Phone Number	Web Site
AMP	1-800-522-6752	www.tycoelectronics.com
Avaya	1-866-462-8292	www.avaya.com
Leviton	1-800-722-2082	www.leviton.com
Panduit	1-800-777-3300	www.panduit.com
Siemon	1-860-945-4200	www.siemon.com

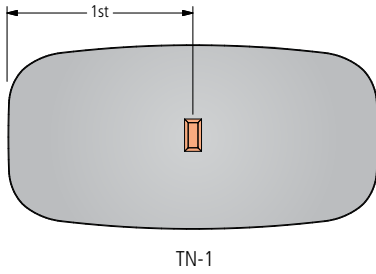
LOCATION CODES

TECH NODE	LOCATION	QUANTITY OF UNITS TO ORDER
TN-1	One at center	1
TN-2	One at each end	2
TN-3	One at center and one at each end	3
TN-4	Four equally spaced	4

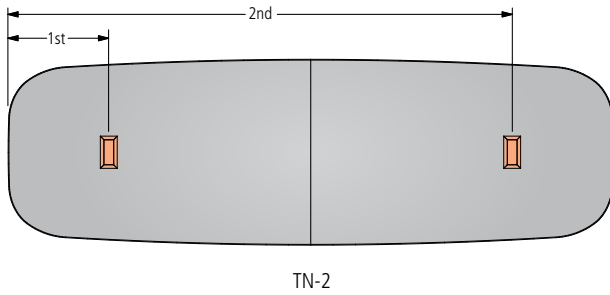


TABLE TOP POWER OPTION: TECH NODE

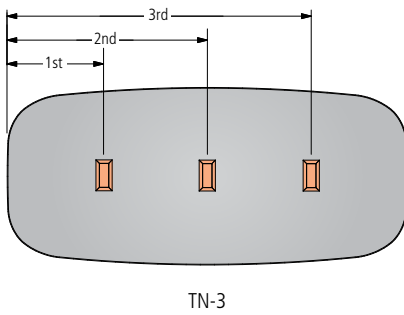
TECH NODE LOCATION OPTIONS



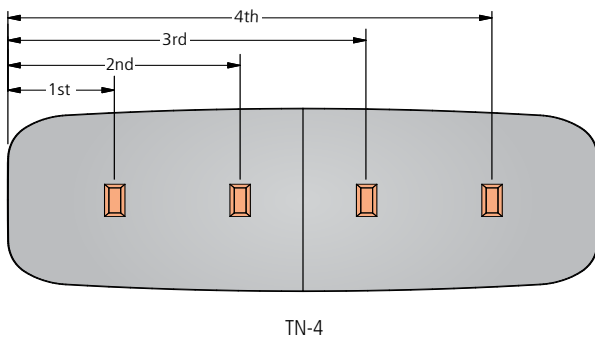
TN-1	
Length	Center of Tech Node
84	42
90	45
96	48
102	51
108	54
114	57
120	60



TN-2		
Length	Center of 1st Tech Node	Center of 2nd Tech Node
84	26	58
90	26	64
96	26	70
102	26	76
108	26	82
114	26	88
120	26	94
132	26	106
144	26	118
156	26	130
168	26	142
180	26	154
192	26	166
204	26	178
216	26	190
228	26	202
240	26	214



TN-3			
Length	Center of 1st Tech Node	Center of 2nd Tech Node	Center of 3rd Tech Node
96	26	48	70
102	26	51	76
108	26	54	82
114	26	57	88
120	26	60	94

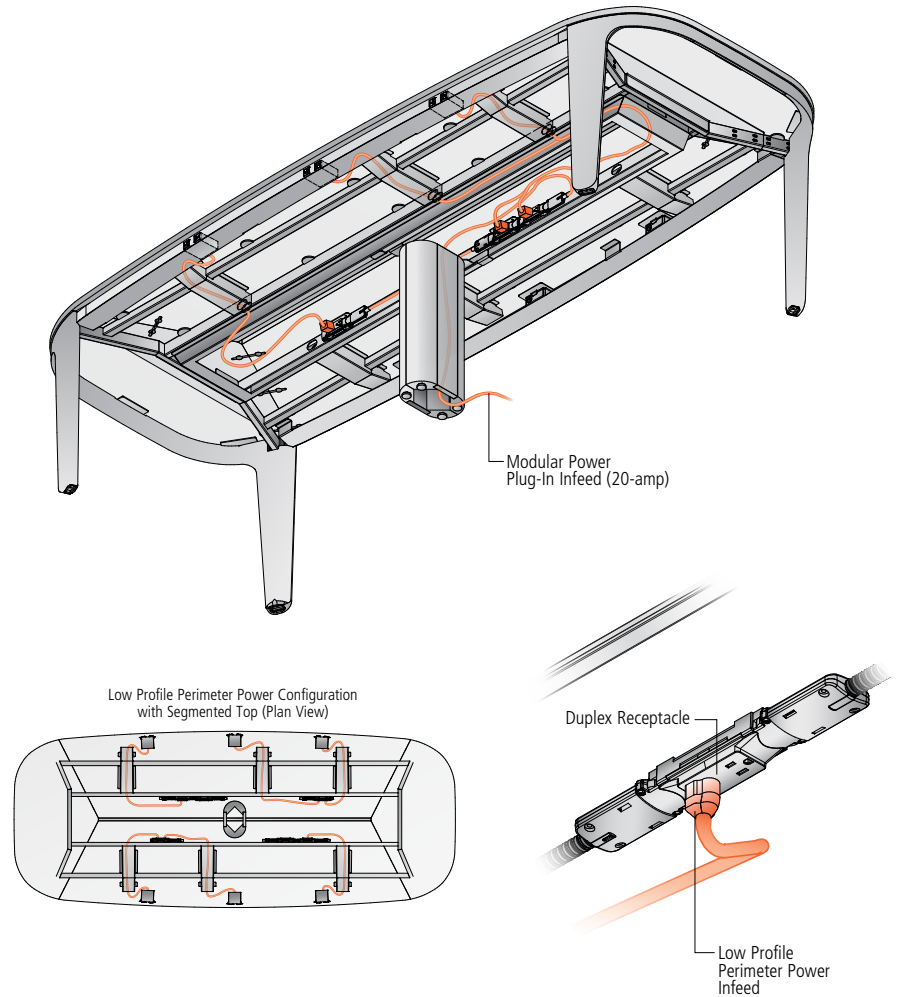


TN-4				
Length	Center of 1st Tech Node	Center of 2nd Tech Node	Center of 3rd Tech Node	Center of 4th Tech Node
132	26	53	79	106
144	26	57	87	118
156	26	61	95	130
168	26	65	103	142
180	26	69	111	154
192	26	73	119	166
204	26	77	127	178
216	26	81	135	190
228	26	85	143	202
240	26	89	151	214



UNDER SURFACE POWER OPTION: LOW PROFILE PERIMETER POWER

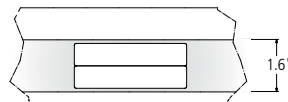
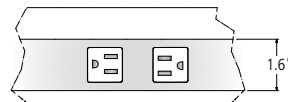
This low-profile option addresses the need for power & data connectivity just below the table top. Housed in the metal rail that runs the length of the table, it offers easy access while also allowing the table top to be visually uninterrupted. The location and total quantity of Low Profile Perimeter Power units are pre-determined based on table length, making specification easy.



Low Profile Perimeter Power is available in three configurations:

- One simplex receptacle and one charging USB-A+C connector (UL Listed)
- Two simplex receptacles (UL Listed)
- Two single space A/V faceplate designed for use with Extron Architectural Adaptor Plates (AAPs)

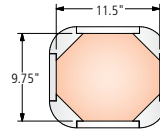
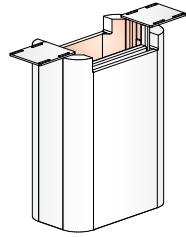
Front Elevation



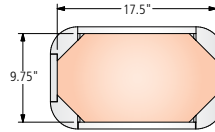


WIRE MANAGEMENT OPENINGS

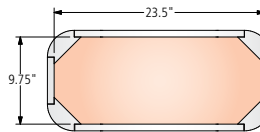
CENTER BASE



48" Wide Tops

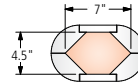


54" Wide Tops



60" Wide Tops

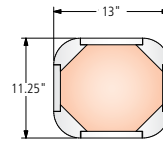
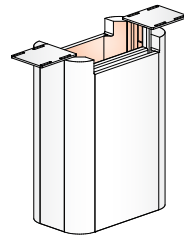
WIRE CHASE COLUMN (NON-STRUCTURAL)



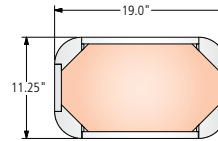


BASE DIMENSIONS

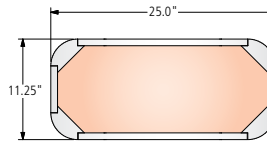
CENTER BASE



48" Wide Tops

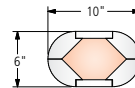


54" Wide Tops



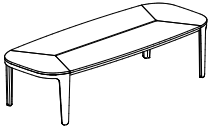
60" Wide Tops

WIRE CHASE COLUMN (NON-STRUCTURAL)





SEGMENTED TABLE TOPS



TOP SURFACE MATERIAL KEY

V Veneer

SOFT RECTANGLE

MODEL #	L x W	TOP SECTIONS	CENTER SUPPORT	SEATING CAPACITY	-V
AMS-8442	84 x 42	4	No	6	14,189
AMS-8448	84 x 48	4	No	6	14,838
AMS-9042	90 x 42	4	No	6	15,006
AMS-9048	90 x 48	4	No	6	15,704
AMS-9642	96 x 42	4	No	6	15,088
AMS-9648	96 x 48	4	No	6	15,801
AMS-10242	102 x 42	4	No	6	16,013
AMS-10248	102 x 48	4	No	6	16,780
AMS-10842	108 x 42	4	No	8	16,099
AMS-10848	108 x 48	4	No	8	16,882
AMS-10854	108 x 54	4	No	8	17,870
AMS-11442	114 x 42	4	No	8	17,036
AMS-11448	114 x 48	4	No	8	17,877
AMS-11454	114 x 54	4	No	8	18,937
AMS-12042	120 x 42	4	No	8	17,127
AMS-12048	120 x 48	4	No	8	17,984
AMS-12054	120 x 54	4	No	8	19,063
AMS-13248	132 x 48	4	Yes	8	23,171
AMS-13254	132 x 54	4	Yes	8	24,520
AMS-14448	144 x 48	6	Yes	10	24,329
AMS-14454	144 x 54	6	Yes	10	25,773
AMS-14460	144 x 60	6	Yes	10	27,527
AMS-15648	156 x 48	6	Yes	10	24,813
AMS-15654	156 x 54	6	Yes	10	26,313
AMS-15660	156 x 60	6	Yes	10	28,131
AMS-16854	168 x 54	6	Yes	12	26,588
AMS-16860	168 x 60	6	Yes	12	28,453
AMS-18054	180 x 54	6	Yes	12	26,863
AMS-18060	180 x 60	6	Yes	12	28,774
AMS-19254	192 x 54	6	Yes	14	27,138
AMS-19260	192 x 60	6	Yes	14	29,096
AMS-20454	204 x 54	6	Yes	14	28,527
AMS-20460	204 x 60	6	Yes	14	30,613
AMS-21654	216 x 54	6	Yes	16	29,515
AMS-21660	216 x 60	6	Yes	16	31,702
AMS-22854	228 x 54	6	Yes	16	30,093
AMS-22860	228 x 60	6	Yes	16	32,351
AMS-24054	240 x 54	6	Yes	18	30,733
AMS-24060	240 x 60	6	Yes	18	33,068

OPTIONS	CODE	PRICE	NOTES
Power and Data Options			See pages 28-34
Wire Chase Column	-WC	\$892	For tables 84"-120"L with two bases
Multi-Section Tops: 102", 108", 114", 120" or 132" four-piece tops split into six sections	Specify -6	\$757	Table top power options (center of table location only) cannot be specified when this option is selected
204", 216", 228" or 240" six-piece tops split into eight sections	Specify -8	\$1,512	

GENERAL INFORMATION

- Seating capacity based on 27" per person
- Overall table height is 29.5"
- An optional Wire Chase Column can be specified for more robust wire management needs. See page 34.

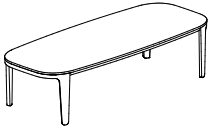
REQUIRED INFORMATION (ORDER CANNOT BE ENTERED WITHOUT THIS INFORMATION)

See appendix pages vi-vii for surface material options.

- Choose Veneer Finish
- Choose Metal Finish for apron



CLASSIC TABLE TOPS



TOP SURFACE MATERIAL KEY

V Veneer

SOFT RECTANGLE

MODEL #	L x W	TOP SECTIONS	CENTER SUPPORT	SEATING CAPACITY	-V
AMC-8442	84 x 42	1	No	6	12,929
AMC-8448	84 x 48	1	No	6	13,535
AMC-9042	90 x 42	1	No	6	13,681
AMC-9048	90 x 48	1	No	6	14,334
AMC-9642	96 x 42	1	No	6	13,763
AMC-9648	96 x 48	1	No	6	14,430
AMC-10242	102 x 42	1	No	6	14,614
AMC-10248	102 x 48	1	No	6	15,334
AMC-10842	108 x 42	1	No	8	14,700
AMC-10848	108 x 48	1	No	8	15,435
AMC-10854	108 x 54	1	No	8	16,359
AMC-11442	114 x 42	1	No	8	15,564
AMC-11448	114 x 48	1	No	8	16,354
AMC-11454	114 x 54	1	No	8	17,346
AMC-12042	120 x 42	1	No	8	15,655
AMC-12048	120 x 48	1	No	8	16,461
AMC-12054	120 x 54	1	No	8	17,472
AMC-13248	132 x 48	2	Yes	8	21,584
AMC-13254	132 x 54	2	Yes	8	22,864
AMC-14448	144 x 48	2	Yes	10	22,680
AMC-14454	144 x 54	2	Yes	10	24,050
AMC-14460	144 x 60	2	Yes	10	25,712
AMC-15648	156 x 48	2	Yes	10	23,147
AMC-15654	156 x 54	2	Yes	10	24,572
AMC-15660	156 x 60	2	Yes	10	26,297
AMC-16854	168 x 54	2	Yes	12	24,847
AMC-16860	168 x 60	2	Yes	12	26,619
AMC-18054	180 x 54	2	Yes	12	25,122
AMC-18060	180 x 60	2	Yes	12	26,941
AMC-19254	192 x 54	2	Yes	14	25,397
AMC-19260	192 x 60	2	Yes	14	27,263
AMC-20454	204 x 54	2	Yes	14	26,715
AMC-20460	204 x 60	2	Yes	14	28,706
AMC-21654	216 x 54	2	Yes	16	27,660
AMC-21660	216 x 60	2	Yes	16	29,748
AMC-22854	228 x 54	2	Yes	16	28,219
AMC-22860	228 x 60	2	Yes	16	30,378
AMC-24054	240 x 54	2	Yes	18	28,838
AMC-24060	240 x 60	2	Yes	18	31,072

OPTIONS	CODE	PRICE	NOTES
Power and Data Options			See pages 28-34
Wire Chase Column	-WC	\$892	For tables 84"-120"L with two bases
Multi-Section Tops: 102", 108", 114", 120" or 132" four-piece tops split into six sections	Specify -6	\$757	Table top power options (center of table location only) cannot be specified when this option is selected
204", 216", 228" or 240" six-piece tops split into eight sections	Specify -8	\$1,512	

GENERAL INFORMATION

- Seating capacity based on 27" per person
- Overall table height is 29.5"
- An optional Wire Chase Column can be specified for more robust wire management needs. See page 34.

REQUIRED INFORMATION (ORDER CANNOT BE ENTERED WITHOUT THIS INFORMATION)

See appendix pages vi-vii for surface material options.

- Choose Veneer Finish
- Choose Metal Finish for apron



POWER AND DATA OPTIONS

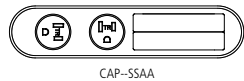
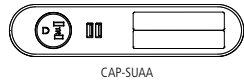
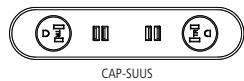
LOW PROFILE PERIMETER POWER	MODEL #	TABLE LENGTH	USB-A+C PORTS	SIMPLEX RECEPTACLES	PRICE	
<p>DEFAULT</p>	LPPP-84-C	84	8	4	5,007	
	LPPP-90-C	90	8	4	5,007	
	LPPP-96-C	96	8	4	5,007	
	LPPP-102-C	102	8	4	5,007	
	LPPP-108-C	108	8	4	5,007	
	LPPP-114-C	114	8	4	5,007	
	LPPP-120-C	120	12	6	7,464	
	LPPP-132-C	132	12	6	7,464	
	LPPP-144-C	144	12	6	7,464	
	LPPP-156-C	156	12	6	7,464	
<p>-LPPWR</p>	LPPP-168-C	168	16	8	9,919	
	LPPP-180-C	180	16	8	9,919	
	LPPP-192-C	192	16	8	9,919	
	LPPP-204-C	204	16	8	9,919	
	LPPP-216-C	216	16	8	9,919	
	LPPP-228-C	228	16	8	9,919	
	LPPP-240-C	240	16	8	9,919	
	<p>-LPDATA</p>					

OPTIONS	CODE	PRICE	NOTES
Two Simplex Receptacles	Add -LPPWR	\$296	
Data	Add -LPDATA	No Charge	
Field-Wired	Add -FW	No Charge	May be required in New York City, Chicago and San Francisco. Check with an electrician for local codes and requirements.

GENERAL INFORMATION

- All electrical components included (unless -FW option is chosen)
- 27" clearance from floor to underside of rail
- Modular power included with both hardwire and direct plug-in infeed options
- When -LPPWR is specified, all power units will have two simplex receptacles
- When -LPDATA is specified, one power unit per length will be replaced to have two single space AAP's
- Detailed information on Low Profile Perimeter Power found on pages 23

FOUR PORT POWER CAP	MODEL #	DESCRIPTION	L x W	SIMPLEX OUTLETS	CHARGING USB-A+C	DATA	PRICE
For use with Rectangle and Ellipse Tables	CAP-SUUS-B-C	Black Simplex	2 x 9	2	2	-	1,620
	CAP-SUUS-W-C	White Simplex	2 x 9	2	2	-	1,620
	CAP-SUAA-B-C	Black Simplex/AAP	2 x 9	1	1	2	1,345
	CAP-SUAA-W-C	White Simplex/Black AAP	2 x 9	1	1	2	1,345
	CAP-SSAA-B-C	Black Simplex/AAP	2 x 9	2	-	2	1,180
	CAP-SSAA-W-C	White Simplex/Black AAP	2 x 9	2	-	2	1,180



OPTIONS	CODE	PRICE	NOTES
Polished Chrome Plate	Add -PCP	\$73 per unit	
Field-Wired	Add -FW	Add \$105 per unit	May be required in New York City, Chicago and San Francisco. Check with an electrician for local codes and requirements.

GENERAL INFORMATION

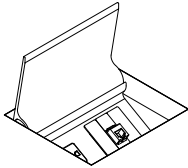
- Available on Classic tops only
- Data includes two single space Extron Architectural Adapter Plates (AAP's)

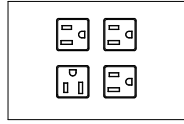
REQUIRED INFORMATION: (ORDER CANNOT BE ENTERED WITHOUT THIS INFORMATION)

- See appendix pages vi-vii for surface material options.
- Choose Metal Finish (unless Polished Chrome has been specified)
 - Choose location code and quantity from chart below

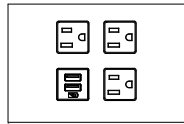


POWER AND DATA OPTIONS

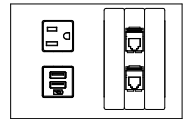
POWER MATRIX SMALL	MODEL #	DESCRIPTION	W x D	SIMPLEX OUTLETS	BLANK	DATA	PRICE
	PM-SM-G	Small - Glass Door	6 x 5.375	2	2	1	1,549
	PM-SM-M	Small - Metal Door	6 x 5.375	2	2	1	1,549
	PM-SM-W	Small - Wood Door	6 x 5.375	2	2	1	1,954



-FOUR



-THREE-C



-USB-C

OPTIONS	CODE	PRICE	NOTES
4 Simplex Receptacles	Add -FOUR	No Upcharge	Replace AAP's with 2 additional simplex receptacles
3 Simplex Receptacles/Charging USB-A+C	Add -THREE-C	No Upcharge	Replace AAP's with 1 additional simplex receptacle and 1 charging USB-A+C
USB-A+C Charging	Add -USB-C	\$121 per unit	USB-A+C charger, replaces one of the simplex outlets
Polished Chrome Door	Add -PD	\$232 per unit	Only available with metal door option
Field-Wired	Add -FW	Deduct \$45 per unit	May be required in New York City, Chicago and San Francisco. Check with an electrician for local codes and requirements.
Single Infeed Option Available	See page 31		

GENERAL INFORMATION

- Power Matrix cord is 144" -long
- Available on Classic tops only
- Wood species and finish will default to the same as the table top if wood door version is specified
- Glass & wood doors are 1/4"-thick, metal doors are 1/8"-thick
- Glass door is back painted low-iron glass
- Interior body is clear anodized aluminum
- Each unit includes a 15 amp, 12' power infeed (plug in only)
- If Field-Wired option is specified, each unit includes a 6' flexible metal conduit and requires a hardwire connection
- Standard configuration: Two simplex receptacles, two RJ-45 data connectors and two single blank faceplates
- Additional data/AV faceplate options are on page 33

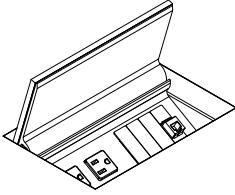
REQUIRED INFORMATION: (ORDER CANNOT BE ENTERED WITHOUT THIS INFORMATION)

See appendix pages vi-vii for surface material options.

- Choose location code & quantity from the chart on page 31
- Choose Glass Door Finish, if glass door version is specified
- Choose Metal Finish, if metal door version is specified



POWER AND DATA OPTIONS

POWER MATRIX MEDIUM	MODEL #	DESCRIPTION	W x D	SIMPLEX OUTLETS	BLANK	DATA	PRICE
	PM-MD-G	Medium - Glass Door	6 x 8.25	4	3	1	2,441
	PM-MD-M	Medium - Metal Door	6 x 8.25	4	3	1	2,441
	PM-MD-W	Medium - Wood Door	6 x 8.25	4	3	1	2,849

OPTIONS	CODE	PRICE	NOTES
USB-A+C Charging	Add -USB-C	\$121 per unit	USB-A+C charger, replaces one of the simplex outlets
Polished Chrome Door	Add -PD	\$312 per unit	Only available with metal door option
Field-Wired	Add -FW	Deduct \$45 per unit	May be required in New York City, Chicago and San Francisco. Check with an electrician for local codes and requirements.
Single Infeed Option Available	See page 31		

GENERAL INFORMATION

- Power Matrix cord is 144" -long
- Available on Classic tops only
- Wood species and finish will default to the same as the table top if wood door version is specified
- Glass & wood doors are 1/4"-thick, metal doors are 1/8"-thick
- Glass door is back painted low-iron glass
- Interior body is clear anodized aluminum
- Each unit includes a 15 amp, 12' power infeed (plug in only)
- If Field-Wired option is specified, each unit includes a 6' flexible metal conduit and requires a hardwire connection
- Standard configuration: Four simplex receptacles, two RJ-45 (data) connectors and three single space blank faceplates
- Additional data/AV faceplate options are on page 33

REQUIRED INFORMATION: (ORDER CANNOT BE ENTERED WITHOUT THIS INFORMATION)

See appendix pages vi-vii for surface material options.

- Choose location code & quantity from the chart on page 31
- Choose Glass Door Finish, if glass door version is specified
- Choose Metal Finish, if metal door version is specified



POWER AND DATA OPTIONS

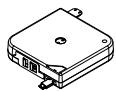
LOCATION CODES	FOUR PORT POWER CAP	POWER MATRIX SMALL	POWER MATRIX MEDIUM	LOCATION	QUANTITY OF UNITS TO ORDER
CP4-1	PS-1	PM-1		One at center	1
CP4-2	PS-2	PM-2		One at each end	2
CP4-3	PS-3	PM-3		One at center and one at each end	3
CP4-4	PS-4	PM-4		Four equally spaced (tables 132" and longer)	4

DOOR MATERIAL AND LOCATION AVAILABILITY BY TABLE SIZE

W = Wood Door G = Glass Door M = Metal Door

LENGTH	TOP SECTIONS	POWER MATRIX SMALL				POWER MATRIX MEDIUM			
		PS-1	PS-2	PS-3	PS-4	PM-1	PM-2	PM-3	PM-4
84	1	W/G/M	W/G/M	-	-	W/G/M	W/G/M	-	-
90	1	W/G/M	W/G/M	-	-	W/G/M	W/G/M	-	-
96	1	W/G/M	W/G/M	W/G/M	-	W/G/M	W/G/M	W/G/M	-
102	1	W/G/M	W/G/M	W/G/M	-	W/G/M	W/G/M	W/G/M	-
108	1	W/G/M	W/G/M	W/G/M	-	W/G/M	W/G/M	W/G/M	-
114	1	W/G/M	W/G/M	W/G/M	-	W/G/M	W/G/M	W/G/M	-
120	1	W/G/M	W/G/M	W/G/M	-	W/G/M	W/G/M	W/G/M	-
132	2	-	W/G/M	-	W/G/M	-	W/G/M	-	W/G/M
144	2	-	W/G/M	-	W/G/M	-	W/G/M	-	W/G/M
156	2	-	W/G/M	-	W/G/M	-	W/G/M	-	W/G/M
168	2	-	W/G/M	-	W/G/M	-	W/G/M	-	W/G/M
180	2	-	W/G/M	-	W/G/M	-	W/G/M	-	W/G/M
192	2	-	W/G/M	-	W/G/M	-	W/G/M	-	W/G/M
204	2	-	W/G/M	-	W/G/M	-	W/G/M	-	W/G/M
216	2	-	W/G/M	-	W/G/M	-	W/G/M	-	W/G/M
228	2	-	W/G/M	-	W/G/M	-	W/G/M	-	W/G/M
240	2	-	W/G/M	-	W/G/M	-	W/G/M	-	W/G/M

RETRACTORS



CR-HDMI

MODEL #	DESCRIPTION	PRICE
CR-CAT6	CAT6 Retractor	944
CR-HDMI	HDMI Retractor	944
CR-DISPLAY	Display Port Retractor	944
CR-USB	Data USB Retractor	944

GENERAL INFORMATION

- Mounting bracket and attaching hardware included with each retractor
- Can only be used with Power Matrix Small or Medium units
- One Cable Pass Through Set (one top, one bottom) AAP FLDF-14 included. Double style AAP
- Two Retractors maximum recommended per each Power Matrix unit. Additional Retractors become visible under the tabletop.
- See page 20 for availability by table size

SINGLE INFEED OPTION

MODEL #	DESCRIPTION	PRICE
SI-H	Single In-Feed Option, Hard-wired	576
SI-C	Single In-Feed Option, Corded (Plug-in)	695

GENERAL INFORMATION

- Tables 72"-120" in length include 2 duplex receptacles with the modular power system
- Tables 132"-240" in length include 3 duplex receptacles with the modular power system
- Hardwired and Corded Single In-Feed options are 7' long
- If Low Profile Perimeter Power is specified, infeed is already provided
- Single In-Feed option cannot be specified in conjunction with the Field-Wired (-FW) option
- Corded Single In-Feed option will require a 20-amp power outlet in the floor monument and reduces the modular electrical system in the table to a single circuit



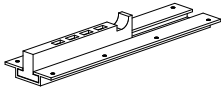
POWER AND DATA OPTIONS

DATA FACEPLATES	MODEL #	DESCRIPTION	STYLE	W x H	PRICE
	FLDF-1	Blank faceplate, single height	Single	3-1/2 x 5/8	77
	FLDF-2	One VGA 15-pin HD Female to Female Gender Changer, one 3.5mm Stereo Mini Jack to Solder Tabs	Single	3-1/2 x 5/8	270
	FLDF-3	One VGA 15-pin HD Female to Female Gender Changer	Single	3-1/2 x 5/8	212
	FLDF-4	One RJ-11 Female to Punch Down - Phone	Single	3-1/2 x 5/8	212
	FLDF-5	One RJ-45 Female to Female Barrel - Data	Single	3-1/2 x 5/8	173
	FLDF-6	Two RJ-45 Female to Female Barrels, single height	Single	3-1/2 x 5/8	232
	FLDF-7	Two RJ-45 Female to Punch Down for CAT 6 - AMP	Single	3-1/2 x 5/8	328
	FLDF-8	Two RJ-45 Female to Punch Down for CAT 6 - Leviton	Single	3-1/2 x 5/8	328
	FLDF-10	Two RJ-45 Female to Punch Down for CAT 6 - Panduit	Single	3-1/2 x 5/8	328
	FLDF-11	Two USB A Female to Two USB A Female on 10" Pigtailed	Single	3-1/2 x 5/8	367
	FLDF-12	Blank faceplate, double height	Double	3-1/2 x 1-3/8	96
	FLDF-13	Two RJ-45 Female to Female Barrels, double height	Double	3-1/2 x 1-3/8	232
	FLDF-14	Cable Pass-Through Set - one top, one bottom	Double	3-1/2 x 1-3/8	405
	FLDF-15	One HDMI Female to Female Barrel	Single	3-1/2 x 5/8	270

GENERAL INFORMATION

- All connectors and faceplates are Extron® Architectural Adapter Plates (AAP)
- Faceplates are black

SLIDING USB	MODEL #	DESCRIPTION	PRICE
	AM-SL-USB-1	One at center (static)	1,450
	AM-SL-USB-2	One at each end (sliding)	2,896
	AM-SL-USB-3	One at each end (sliding) and one at center (static)	4,341



AM-SL-USB-2

OPTIONS	CODE	PRICE	NOTES
Field-Wired	Add -FW	No Charge	May be required in New York City, Chicago and San Francisco. Check with an electrician for local codes and requirements.

GENERAL INFORMATION

- End units slide open and closed, center unit is stationary
- Each USB unit includes (3) USB-A and (1) USB-C connectors
- Available on Segmented tops only
- Not available in Clear or Black Anodized

REQUIRED INFORMATION: (ORDER CANNOT BE ENTERED WITHOUT THIS INFORMATION)

- See appendix pages vi-vii for surface material options.
- Choose Metal Finish

RETROFIT SLIDING USB	MODEL #	DESCRIPTION	PRICE
	AM-RETRO-USB-1	Static placement - one at center	1,450
	AM-RETRO-USB-2	Static placement - one at each end	2,896
	AM-RETRO-USB-3	Static placement - one at each end and one at center	4,341

OPTIONS	CODE	PRICE	NOTES
Field-Wired	Add -FW	No Charge	May be required in New York City, Chicago and San Francisco. Check with an electrician for local codes and requirements.

GENERAL INFORMATION

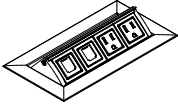
- Retro-fit applications only allow for static power option
- Each USB unit includes (3) USB-A and (1) USB-C connectors
- Available on Segmented tops only
- Not available in Clear or Black Anodized

REQUIRED INFORMATION: (ORDER CANNOT BE ENTERED WITHOUT THIS INFORMATION)

- See appendix pages vi-vii for surface material options.
- Choose Metal Finish



POWER AND DATA OPTIONS

TECH NODE	MODEL #	W X D	SIMPLEX RECEPTACLES	OPEN DATA PORTS	CHARGING USB-A+C	PRICE
 PUP	PUP	8 x 4	2	2	-	565
	PUP-USB-AC	8 x 4	2	1	1	673

OPTIONS	CODE	PRICE	NOTES
Field-Wired	Add -FW	No Charge	May be required in New York City, Chicago and San Francisco. Check with an electrician for local codes and requirements.

GENERAL INFORMATION

- 12' cord and a 15amp plug-in power in-feed
- Available on Classic tops only
- Voice/data modules must be ordered separately; contact your local AV integrator
- Default color to metal finish specified on tables (Shadow, Storm, Black, Aged Bronze, Satin Bronze and Galaxy receive Black Anodized Tech Node; Cloud, Burnished and Foil receive Clear Anodized Tech Node)
- Round tables with cylinder bases do not have visible metal components, specify metal finish for Tech Node: Clear or Black Anodized
- UL listed
- Includes a Voice/Data Adapter Kit to accept couplers and jacks when required
- Detailed planning information found on pages 21-22

REQUIRED INFORMATION: (ORDER CANNOT BE ENTERED WITHOUT THIS INFORMATION)
 See appendix pages vi-vii for surface material options.
 ▪ Choose location code and quantity from chart below

LOCATION CODES	TECH NODE	LOCATION	QUANTITY OF UNITS TO ORDER
	TN-1	One at center	1
	TN-2	One at each end	2
	TN-3	One at center and one at each end	3
	TN-4	Four equally spread	4

GROMMET	MODEL #	DESCRIPTION	DIAMETER	PRICE
	GR	Round Grommet	2" Dia	229

OPTIONS	CODE	PRICE	NOTES
Polished Chrome Grommet	Add -PCG	\$90 per unit	

GENERAL INFORMATION

- Metal finish will default to the metal chosen for the table unless otherwise specified
- Available at center location only
- Available on Classic tops only

REQUIRED INFORMATION: (ORDER CANNOT BE ENTERED WITHOUT THIS INFORMATION)
 See appendix pages vi-vii for surface material options.
 ▪ Choose Metal Finish: Powder Coat, Clear Anodized or Polished Chrome (upcharge applies)



POWER AND DATA OPTIONS


WIRE CHASE COLUMN	MODEL #	DESCRIPTION	PRICE
	AM-WC	Wire Chase Column	892

GENERAL INFORMATION

- To be used with (2) base tables (Not intended as a center support)
- Wire management opening is 7" x 4.5"

REQUIRED INFORMATION: (ORDER CANNOT BE ENTERED WITHOUT THIS INFORMATION)
 See appendix pages vi-vii for surface material options.

- Choose Veneer Finish

POWER SILO	MODEL #	DESCRIPTION	PRICE
	VDEO	Power Silo with Cable Management Disc	935

GENERAL INFORMATION

- Use when power source (floor monument) falls outside of the leg or base solution
- The VDEO has a 9" range from centerline of table to floor monument
- Protects cables from the floor to the table
- Easily adjustable by adding or removing individual clip elements
- Flexible channel constructed of a durable polymer, 32" long with a 1" radius
- Weighted metal cable management disc is 1-3/4" H with 2" radius

REQUIRED INFORMATION: (ORDER CANNOT BE ENTERED WITHOUT THIS INFORMATION)
 See appendix pages vi-vii for surface material options.

- Choose Color: Gray or Black



Appendix



GENERAL INFORMATION

This price book supercedes all previous versions.

Before placing your order, confirm you have all required information necessary. Lead times for orders begin after all required information is included and correct.

Delivery Information

We know lead times are important and sticking to them even more so. We work to maintain a 6-8 week lead time on all standard products in this book from receipt of a clean order. All orders are acknowledged with an approximate shipping date and will be invoiced with the price in effect at the date the purchase order is received. For current lead times, please review www.nucraft.com/resources/lead-times.

Shipping charges are prepaid (within the continental U.S.). Therefore, pricing is a delivered price based on normal ground transportation. If you have special instructions, need to ship by air, or are shipping to Alaska or Hawaii, contact Nucraft Customer Service. Nucraft can also help arrange to have products blanket wrapped for an additional charge. Contact the Nucraft Customer Service team or specify it on your purchase order.

Minimum Freight Charge: Any order below \$2,900 net will be assessed a \$475 net minimum freight charge (one per order).

Orders are subject to acquiring the materials required for manufacturing. Fulfillment can be affected by strikes, fires, embargoes and acts of government. These elements are beyond our control.

Nucraft offers a variety of services to accommodate a wide range of delivery requirements. Availability of these services is dependent on a number of factors and may not be offered with all shipments. Examples of delivery services that have additional fees include:

- Specific date
- Specific time of day, morning or afternoon
- Delivery to a warehouse before delivery to its final destination (unless product is picked up at the warehouse)

Contact the Nucraft Customer Service team for availability and pricing on these services.

Freight Terms

Shipping charges for Nucraft products are prepaid for standard delivery in the continental United States. Standard delivery is defined as follows: Product is delivered on a 53' trailer being pulled by a long-haul tractor (total length of 85'). Facility will receive delivery Monday through Friday between the hours of 8:00 AM and 4:00 PM. Facility has docks with levelers and a fork truck for unloading. Product will be loaded on load bars two levels high. Receiving facility is responsible to have personnel on hand to unload the truck upon arrival, drivers do not unload. Delivery sites or times that do not meet these criteria may be accommodated, but will incur a charge to cover additional shipping costs. Please **notify Nucraft a minimum of two weeks prior to shipment** to arrange special services and determine additional charges.

Storage

Nucraft has no storage facilities for finished product. If a customer cannot accept an order when it is ready for shipment, the customer must designate an alternative shipping address. If no address is provided, Nucraft may, at its discretion, transfer the product to storage. If product is transferred to an off-site storage facility, the customer may be charged for transportation to the facility and for any associated storage fees. Nucraft considers transfer of the product to a storage facility the equivalent of shipment, including invoicing and payment. Customers assume the risk of damage or loss during storage.

Transportation Times and Delays

Third party carriers that Nucraft contracts with will make reasonable efforts to accommodate requested delivery times and dates. Scheduled delivery appointments may, however, be delayed for a variety of reasons, including inclement weather, traffic, transportation equipment problems, and delays encountered at other delivery locations along the delivery route. Nucraft does not recommend scheduling activities that depend on the delivery appointment (for example, scheduling furniture installers to install furniture the day of the delivery appointment). Nucraft shall not be liable for any costs incurred as a result of a missed delivery appointment.

Shipment Damage Claims

Legal title to merchandise passes to the buyer upon acceptance by the carrier. Inspect all cartons upon delivery. Details of visible damage should be noted on the delivery receipt. Do not destroy packaging, transport to site, or install product if damage is found upon inspection. Inspection of products should be completed upon delivery to the receiver. If visible damage is apparent, a claim should be filed immediately with Nucraft Customer Service. If visible damage is not apparent, sign the delivery receipt "No visible damage." This will allow recourse for a concealed damage claim. Concealed damage claims must be filed within 15 days of receipt, **prior to transporting or installing any product.**

Do not destroy packing materials until shipment has been inspected. If damage is found, proceed to file a claim with Nucraft Customer Service.

Failure to make any claims against Nucraft within 15 days shall constitute acceptance of the merchandise and a waiver of any defects, errors or shortages discovered upon inspection.

Cancellations

Cancellations must be reviewed by our Customer Service team. Because we build your products to order, orders cannot be cancelled once processing has begun. Processing includes but is not limited to development of shop drawings and other engineering drawings. If cancellation is approved, a processing fee of 20-100% will be assessed based on the status of the order.

Change Order Policy

Nucraft will make every attempt to honor any reasonable change request to product provided that the request is received prior to start of production. Change orders will be accepted only if the request is made in writing and received in time to make the change. Nucraft reserves the right to increase our acknowledged price and ship date if necessary to make the requested changes. Please submit any change order request to our Customer Service team. Nucraft will assess charges to the customer as stipulated in the following:

- Standard Orders: Change orders received prior to production will be charged \$400 net to cover administrative costs.
- Special Orders: Change orders received prior to production will be charged \$400 net to cover administrative costs. There may be additional costs associated with engineering labor required for the change order.
- Change orders received after production must be evaluated by Nucraft. If approved, the charge will be \$400 net plus any restocking charges accumulated. There may be additional costs associated with engineering and/or manufacturing labor, as well as material costs, required for the change order.



GENERAL INFORMATION

Repair Authorization

Prior written approval is required for repairs of merchandise charged to Nucraft. Failure to do so will result in customer funded repairs.

Payment Terms

Deposits are required at the time of order due to the custom nature of our products. See information regarding Cancellations above.

Credit terms are available to qualified customers. Please contact AR@Nucraft.com to start the application process. Note that the credit application process requires a valid sales tax exemption or resale tax certificate, Form W-9, and three current trade references.

Credit Card Payments are accepted via web portal. Please contact AR@Nucraft.com for payment instructions. Note that a 2% convenience fee will be added for using this payment method and no early pay discounts are allowed on credit card payments.

Warranty

Nucraft Furniture is warranted to be free from defects in materials and workmanship for a period of ten years of single shift use. Limitations include:

- Mechanical Devices such as latches, casters, and other moving components are warranted for five years of the date of original delivery.
- Height adjustable components are warranted for two years of the date of original delivery.
- The following are warranted for one year of the date of original delivery:
 - Textiles
 - Electrical Components
 - Refrigeration Units
 - Custom Products not described in Nucraft's Catalogue

This warranty is applicable only if furniture is properly installed and maintained in an office environment. This warranty extends only to products manufactured and sold in North America and only to original purchasers acquiring new Nucraft product through authorized dealers or approved sellers.

During this warranty period, Nucraft's sole obligation is to repair or replace, at Nucraft's discretion, products which prove to be defective during the warranty period.

This warranty does not cover:

- Damage caused by a carrier.
- Damage from user modification, misuse, abuse, accident, or negligence.
- Customer's Own Material (COM) specified by the customer that is not a standard product offering.
- Color, grain, or texture of wood and other covering material.

Nucraft extends no other warranties, expressed or implied, including warranty of merchantability or fitness for a particular purpose. Nucraft shall not be liable for loss of time, inconvenience, commercial loss, incidental or consequential damages.

Environmental Statement

Nucraft is committed to supporting responsible environmental policies and practices in all that we do. We strive for sustainability, weighing our business decisions against the costs to the ecological, social and economic systems they affect.

Our products are manufactured to meet the credit requirements of the U.S. Green Building Council's LEED rating systems in one or more of the following categories:

- Recycled Content
- Certified Wood
- Low-Emitting Materials

Computer Aided Planning

Nucraft products and pricing are available via CET and 2020 Cap, an AutoCAD®-based space planning tool.

2020 Cap is an integrated software system developed specifically for interior designers and facility planners to enhance workplace performance. This modern suite of applications works together seamlessly, in concert. Navigate catalogs, select products, design in plan view and 3D, assign options, create worksheets and build a project where you want, when you want. Take your pick. It's dynamic and interactive. Design projects are a work in progress. And now you can perform any of the many discrete tasks that go into a project any time, any place.

For additional information, you may contact 2020 Cap direct at 800-227-0038.

Product symbols (Revit, 2D and 3D) are available on the Nucraft website at www.nucraft.com/resources/product-symbols.

iSpec®

Nucraft offers a free online product configuration and specification service that saves you time and allows you to be creative while leaving the nuts and bolts to someone else. No specific software is required, nor is there any learning curve. This service applies to all Nucraft products. For additional information, call 1-877-NUCRAFT and ask for the iSpec Team or log on to www.nucraft.com/resources/ispec.



FINISH INFORMATION

Surface Materials Palette

We crafted our materials palette using the same demanding standards that distinguish our furniture. Thoughtful design and attention to every detail elevate your possibilities.

Anchored by Nucraft veneers, unrivaled for clarity, quality, and depth of finish, our collection of surface materials comprises a sophisticated set of balanced elements that supports your design vision.

Some elements have their roots in Nucraft's rich heritage. Others are new materials and reflect current trends and taste. Together, they ensure that you're ready for today and positioned well for the future. Beautifully.

Custom Finishes

Nucraft specializes in expert custom finish matching. For a nominal upcharge we can provide custom finishes, and we are frequently asked to match the finishes of other furniture manufacturers. For finishes that appear unusual to match or for customers directly requesting a sample, a finish sample will be sent for approval prior to entering the order.

Custom finishes requiring colored varnishes to create a painted look can only be applied to Maple veneer and require one extra week in addition to the standard lead time. Nucraft's standard black finish (G82) can be applied to all Nucraft standard veneers. Walnut is the standard black veneer. Other species must be specified when ordering.

Clear coat on a special veneer requires an approved sample.

Custom finishes carry a 10% upcharge per item, per finish, capped at \$2,100 List.

Custom finish upcharges are not applied to any item that is not wood. Example: casters, ganging connectors, power options..

Treatments

Note: Default veneer sheen will vary per finish and product. Default finish is bolded on pages vi-vii. If no direction is provided on incoming orders, default sheen will be selected. In addition, default veneer cut is noted in the price list. If no direction is provided on incoming orders, default cut will be selected.

Gloss: Gloss is a durable finish that tends to nicely mask normal wear and leaves wood grain visible to the eye. It achieves a medium gloss open pore appearance (40 – 50 sheen range). Finish numbers preceded by the letter "G" indicate a Gloss finish.

Matte: Like Gloss, Matte is durable, tends to nicely mask normal wear and leaves wood grain visible to the eye. It achieves a low luster, open pore appearance (10 – 20 sheen range). Finish numbers preceded by the letter "M" indicate a Matte finish.

Since each veneer type responds differently to both types of treatment, all will have a distinctive look and feel when finished. For example, a Walnut veneer with a Gloss treatment will remain much more textured than a Cherry veneer with the same treatment.

About the Wood

All Nucraft veneers are carefully selected for uniformity of color and grain. Still, wood is a natural substance and minor variations may occur due to its own uniqueness. Because of this, the furniture you receive may not be an exact match to our samples.

Nucraft takes great pride in our finish color consistency. However, wood is a natural product that will have color variation within a single piece of furniture, as well as from one piece to the next. Other factors also affect color over time, such as exposure to light (both intensity and duration). For example, lighter finishes cause more variation in colors over time.

In cases where a returning customer wants a precise match with existing furniture, we recommend sending a sample of the existing furniture finish. Please contact Nucraft Customer Service to determine an appropriate sample. This will ensure a finish match between old and new orders. This type of order is considered a control sample. There will be a 10% upcharge on an order of this type. Due to natural aging of veneers, natural finishes may vary.

Care and Maintenance of Wood Finishes

Our finish material is a crystal clear, urethane acrylic blend. This type of finish may be repaired in the field by a qualified refinisher.

Nucraft recommends using a damp cloth to clean your fine wood furniture. Always wipe with the grain of the wood. Should your wood furniture require a more thorough cleaning, we recommend using a mild cleaner such as Joy dish soap or Murphy's oil soap, thoroughly diluted in water (one part soap to thirty parts water). Water will not damage Nucraft's finish, but it may leave surface spots when it dries. To avoid this, dry the surface with a soft cloth after it is cleaned. Marks that cannot be removed with the cleaning methods above may be able to be removed using naphtha, a mild degreasing solvent.

Caution: while the use of polishes that contain wax, petroleum solvents or silicones may immediately enhance the "shine" of a product, it may also eventually remove the fine original finish applied in our factory. Silicone on the surface of wood may also make it very difficult to respray or refinish.

All Nucraft furniture is inspected and polished before it leaves our factory. In some instances, the packing materials may imprint on the factory polish. Cleaning and polishing the furniture once it is unpacked will normally restore the furniture to its original beauty.

In some cases, the rubber support feet used on the bottom of common office equipment (teleconferencing phones, laptops, microphones, copiers, etc.) can create unsightly marks in the surface of wood tops, due to oxidation of the lacquer finish. We suggest these machines be placed on a protective type of padding, such as felt.

Wood will fade as a result of exposure to UV light. This is particularly prevalent with light finishes. If color changes due to fading are a concern for your application, the impact can be minimized by selecting medium to dark stains for your wood surfaces. Our top coat includes a UV inhibitor which makes the finishes less prone to fading.



FINISH INFORMATION

Laminates

Selected Formica®, Nevama®, and Wilsonart® laminates are available on Training Tables, Conference Tables, Conference Room Furniture and select Occasional Tables. For standard laminate and wood pricing, refer to individual item pricing columns.

Non-Standard Laminates and Linoleums

To order a color other than those on our list (see pages vi-vii), refer to Nevamar or Formica standard grade, matte texture laminate offerings and Forbo Furniture Linoleums (excluding manufacturers' non-standard matte offering).

Nucraft can support other laminate and linoleum options beyond what can be found as standard options on pages vi-viii. For pricing, please send a request to quotes@nucraft.com.

Care and Maintenance of Laminate and Novawrap

Laminate and Novawrap surfaces may be cleaned with a damp cloth and ordinary soap or non-abrasive household liquid detergent. Dry the surface with a clean cloth or soft paper towel to prevent streaks from appearing.

Care and Maintenance of Metal

Metal surfaces can be wiped with a damp cloth and rubbed dry. A mild non-abrasive household liquid detergent can be used if necessary. Regular maintenance of metal components, including tightening of fasteners and light lubrication of moving parts, will extend the life of your furniture.

Satin Etched Glass

Glass color may vary slightly on multi-piece conference table tops over 180" x 60" when satin etched glass is specified due to the iron content and etching process of the glass.

Care and Maintenance of Glass

Clear or frosted glass may be cleaned with commercial glass cleaner. Be sure to use a lint-free cloth if cleaning the frosted side of the glass.

Stone and Solid Surface Material

Despite its reputation for durability, natural stone can easily be broken during handling and/or installation if proper techniques are not followed. In addition, Nucraft is not responsible for the installation of natural stone or solid surface materials on its products. Therefore, installers specifically trained in the installation of these materials must be utilized to ensure a quality installation. Nucraft shall not be liable for any damages incurred during the handling and/or installation of natural stone or solid surface materials on its products.

Care and Maintenance of Granite

Granite surfaces may be cleaned with a damp cloth and ordinary soap or non-abrasive household liquid detergent. Dry the surface with a clean cloth or soft paper towel to prevent streaks from appearing.

Care and Maintenance of Leather

Genuine leather requires very little care. Nucraft recommends that leather be dusted regularly. If a more thorough cleaning is needed, use lukewarm water and a mild, non-abrasive soap. Generate some lather and lightly rub the surface with cheesecloth. Rinse off any soap film with clean water and towel dry. The leather may dry dull. To restore the leather to a normal gloss, rub it with a clean towel. Never use furniture polish, oil, varnish or ammonia. Saddle soap may be used to prevent the leather from becoming brittle or cracked and to maintain the original supple finish.

Touch Up Finish Kits

Model #	Description	Price
KIT-M	Metal Kit	85
KIT-P	Paint Kit	85
KIT-S	Stain Kit	85

REQUIRED INFORMATION: (ORDER CANNOT BE ENTERED WITHOUT THIS INFORMATION)

- Kit model number
- Quantity of kits
- Specify finish (See pages vi-vii)

General Information:

- Touch-up kits must be ordered on a purchase order separate from Nucraft product due to Hazmat shipping

Retrofit & Replacements

If needing a partial placement or retrofit solution, please reach out to our quote team. Grain/color matched in a set.



ALEV SURFACE MATERIALS

WOOD FINISHES

STANDARD

Default veneer sheen will vary per finish and were determined by a team of experts who reviewed the colorways to determine if gloss or matte best highlighted the natural characteristics of the species of wood and the color of the stain. Default finish is bolded. If no direction is provided, default sheen will be selected.

	Matte	Gloss
Rift Cut Oak		
Carbon	M03	G03

Flat Cut Oak		
Dune	M05	G05
Portobello	M7413	G7413

Flaky Oak		
Sahara	M61	G61

Quarter Cut Cherry		
Cognac	M21	G21
Auburn	M93	G93

Quarter Cut Walnut		
Marron	M35	G35
Mocha	M33	G33
Zinc	M30	G30
Onyx	M82	G82
Otter	M31	G31

Quarter Cut Maple		
Natural Maple	M60	G60

METAL FINISHES

Powder Coat

Aged Bronze	A8010
Black	A44
Burnished	A8009
Cloud	A8004
Foil	A8006
Galaxy	A8007
Moonlight	A87
Satin Bronze	A8011
Shadow	A8005
Storm	A8012

Metal

Polished Chrome**	PC
Satin Bronze Plating*	SBP

*Only available on Sliding USB

**Only available on Grommet, Power Cap and Power Matrix. Upcharge applies.