

ASCARI™ CASEGOOD

Planning Guide + Price List

Product Design Consultant: Gensler

QUICK LINKS

[PLANNING GUIDE](#)

[ASCARI CASEGOOD TYPICALS](#)

[ASCARI CASEGOOD PRICING](#)

[SMALL MEETING TABLES](#)

[POWER AND DATA OPTIONS](#)

[GENERAL INFORMATION](#)

[FINISH INFORMATION](#)

[SURFACE MATERIALS](#)



TABLE OF CONTENTS

Click the shortcuts below to jump to each section.

General Information	ii-iii
Finish Information	iv-v
Surface Materials	vi-viii
Order of Specification	3
Work Surface Support Options	4-5
Applications	6-7
Typicals	8-18
Planning Guide	19-23
Price list	24-84



ORDER OF SPECIFICATION

STATIC ASCARI CASEGOOD APPLICATIONS

1. Determine Typical Shape:

- Freestanding
- T-Shape
- L-Shape
- U-Shape

2. Choose Desks

- Supports
- Modesty

3. Choose Secondary Work surface

- Access Panel (optional)
- Supports

4. Select Overhead and Back Panel Options

Starting from uppermost left corner working across to far right and then below left to right.

5. Choose Freestanding Options

- Tower
- Lateral File
- Meeting Table

HEIGHT ADJUSTABLE ASCARI CASEGOOD APPLICATIONS

1. Determine Typical Shape:

- Freestanding
- T-Shape
- L-Shape
- U-Shape

2. Choose Desk and Support

- Secondary Supports
- Modesty

3. Choose Secondary Work surface

- Supports

4. Select Overhead and Back Panel Options

Starting from uppermost left corner working across to far right and then below left to right.

5. Choose Freestanding Options

- Tower
- Lateral File
- Meeting Table

FREESTANDING

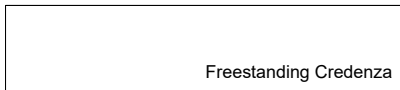

T-SHAPE

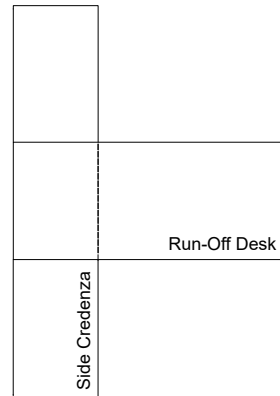

L-SHAPE

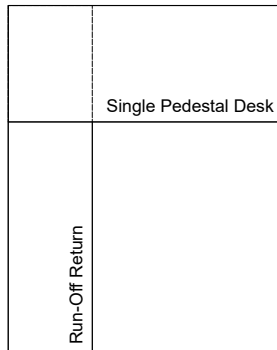

U-SHAPE

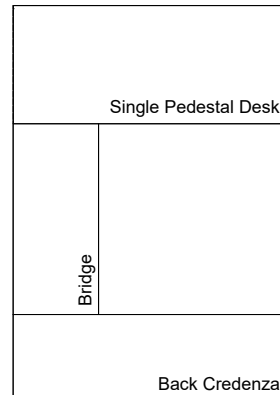



STATIONARY WORK SURFACE SUPPORTS

DESK SUPPORTS

Pages 28-29

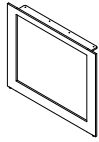

Hoop Leg

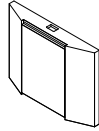

Faceted Panel Leg

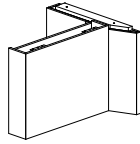

Faceted Peninsula Support

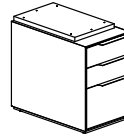

Box Box File Pedestal

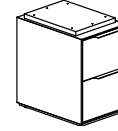

File File Pedestal

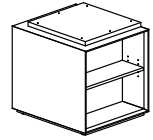

Bookcase

COMMON CASE

Pages 50-53

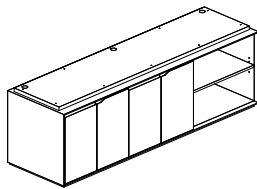

L-Shape Double Door & Open Shelf

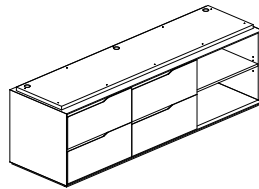

L-Shape Lateral File & Open Shelf

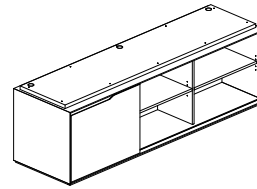

L-Shape Open Shelf with Sliding Doors

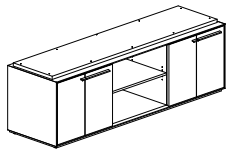

T-Shape Double Door & Open Shelf

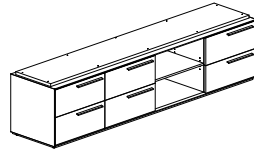

T-Shape Lateral File & Open Shelf

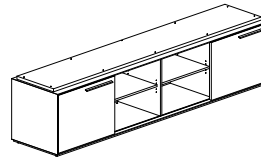

T-Shape Open Shelf with Sliding Doors

RETURN/CREDENZA SUPPORTS

Pages 43-44

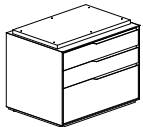

Box Box File

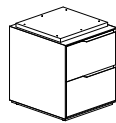

File File

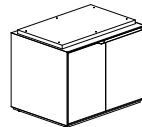

Double Door

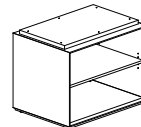

Open Shelf

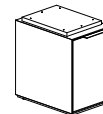

Trash/Recycle

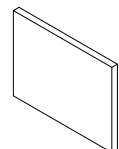

End Panel

ACCESS PANEL

Page 37

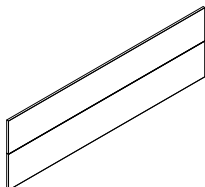



ADJUSTABLE HEIGHT WORK SURFACE SUPPORTS

DESK SUPPORTS

Pages 30-32

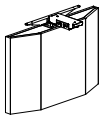

Faceted Panel Leg

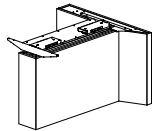

Faceted Peninsula Support

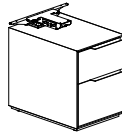

Box File Pedestal

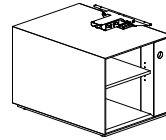

Bookcase

LOW COMMON CASE

Pages 47-49

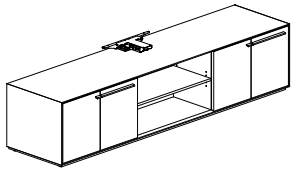

T-Shape Double Door & Open Shelf

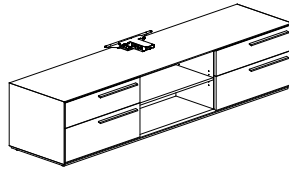

T-Shape Lateral File & Open Shelf

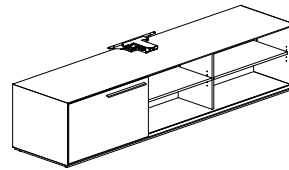

T-Shape Open Shelf with Sliding Doors

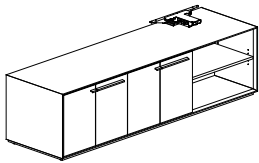

L-Shape Double Door & Open Shelf

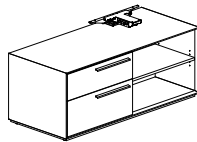

L-Shape Lateral File & Open Shelf

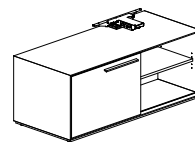

L-Shape Open Shelf with Sliding Doors

RETURN/CREDENZA SUPPORTS

Pages 47

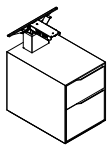

Box File

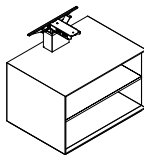

Open Shelf

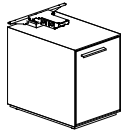

Single Door

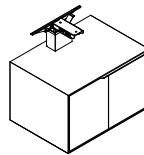

Double Door

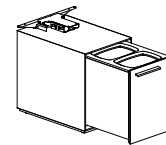

Trash/Recycle

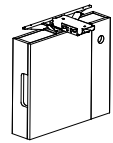

End Panel

ACCESS PANEL

Page 38

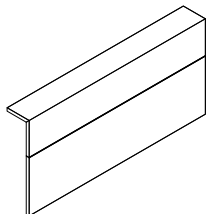



STANDARD HEIGHT APPLICATIONS

Ascari Casegood is available in two application planes: Low Height and Standard Height. Standard Height applications are on the same plane.

Shaded work surfaces illustrate which work surfaces are available as height adjustable. Dark gray indicates both work surfaces are height adjustable. Light gray indicates an independent height adjustable work surface.

T-Shape

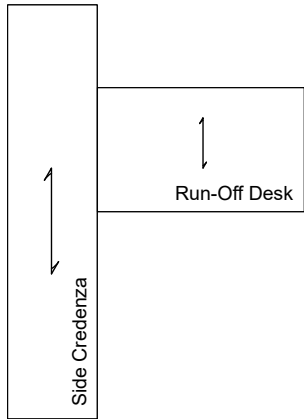

Freestanding

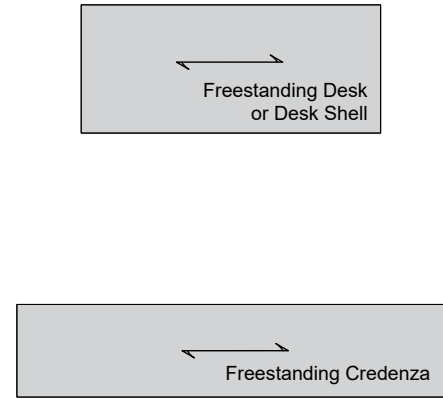

- Both Work surfaces Height Adjustable
- Independent Height Adjustable Work Surface

Back U-Shape

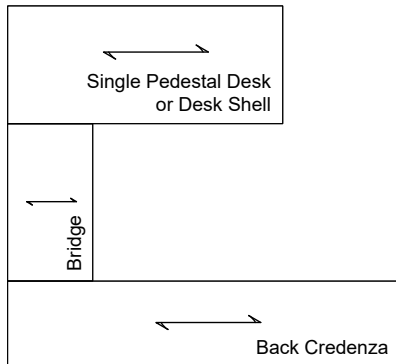

Back U-Shape

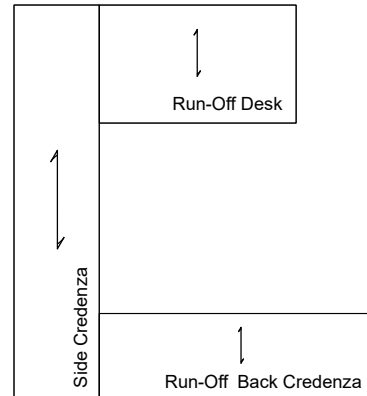

L-Shape with Single Pedestal Desk or Desk Shell

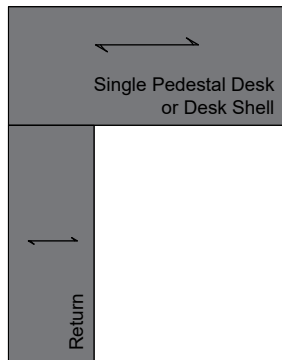

L-Shape with Run-Off Desk

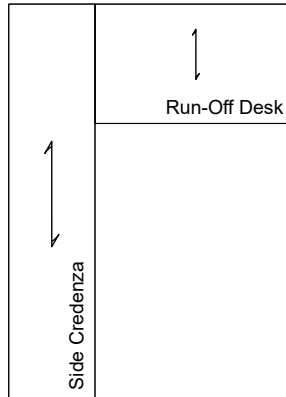

L-Shape

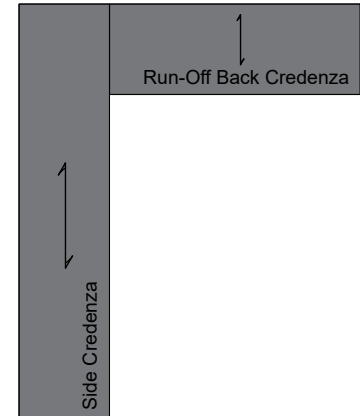



LOW HEIGHT APPLICATIONS

Ascari Casegood is available in two application planes: Low Height and Standard Height. Low Height applications are layered over a Low Credenza.

Shaded work surfaces illustrate which work surfaces are available as height adjustable. Dark gray indicates both work surfaces are height adjustable. Light gray indicates an independent height adjustable work surface. Grain direction will run the depth for run-off desks or the length for single pedestal desks.

L-Shape

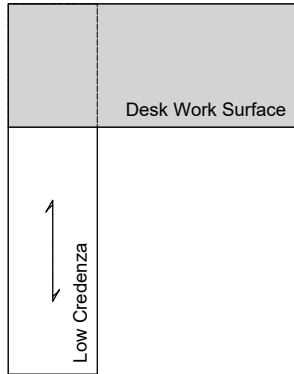

T-Shape

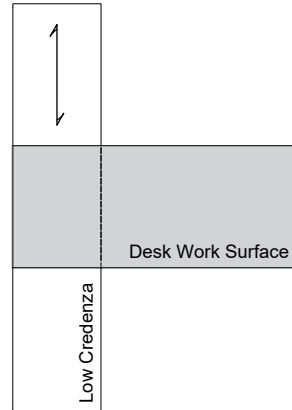

- Both Work surfaces Height Adjustable
- Independent Height Adjustable Work Surface

Side U-Shape

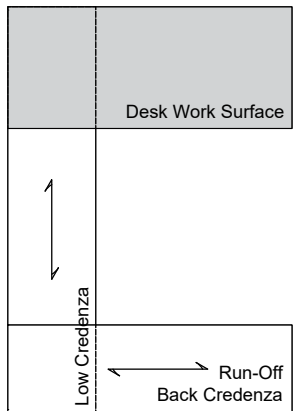

Back U-Shape

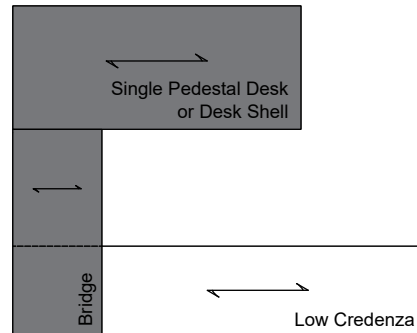

Side F-Shape

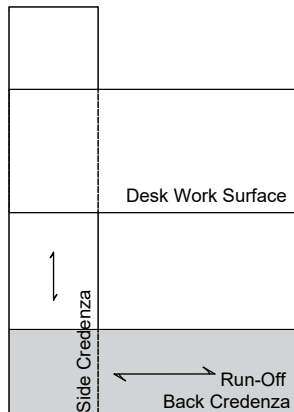

Freestanding

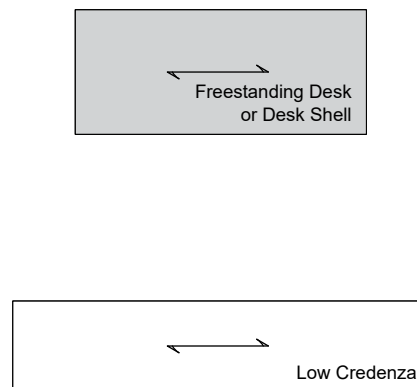



ASCARI CASEGOOD TYPICALS



FREESTANDING DESK WITH ADJUSTABLE HEIGHT PANEL BASE

PROGRAMMABLE CONTROLLER

The programmable controller features up/down buttons, four programmable preset stops, and a digital readout that displays the worksurface height.

RECOMMENDED ACCESSORIES

- Freestanding Storage Pedestal (page 80)
- Plug Strip (page 84)

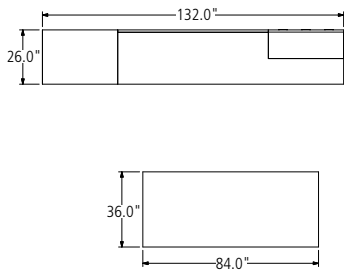
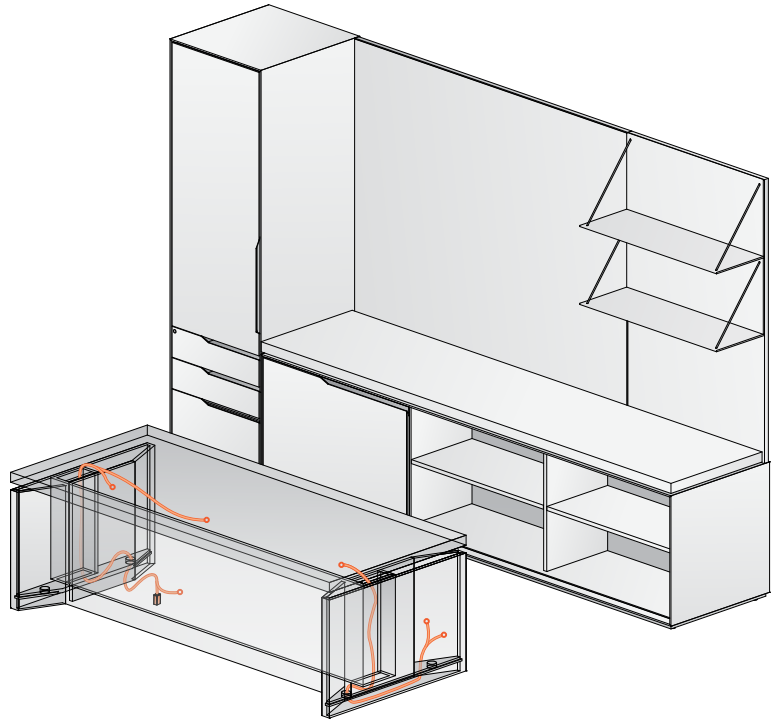

TYPICAL ASC-01-F

COMPONENT	MODEL #	DIMENSIONS	DESCRIPTION	PRICE
Height Adjustable Freestanding Desk	AAAFD-3684-V	36 X 84	Height Adjustable Faceted Panel Legs, Work Surface and Modesty	15,049
Tower	AABBF-2426-84-V-L	24 x 84 x 26	Box/Box/ File with Upper Doors Wardrobe	10,133
Work Surface	AAC-24108-V	24 X 108	Credenza Work Surface	4,981
Common Case Credenza	AACC-T-SD-10826-V	108 x 26 x 27	Common Case Credenza with (3) 36" w openings and (1) 36" w sliding door	10,962
Integrated Pull	-MIP		Integrated Pull with Metal Accent	-
Wall Panel	AAGB-7256	72 x 56.5	Magnetic Glass Wall Panel	5,381
Ascari Storage Shelves	AAS2-3656-V	36 x 56.5	Ascari Series Double Stacked 36" w Metal Storage Shelves with Veneer Wall Panel	2,862

Private Office List Price: \$49,368

PANEL BASE WIRE MANAGEMENT

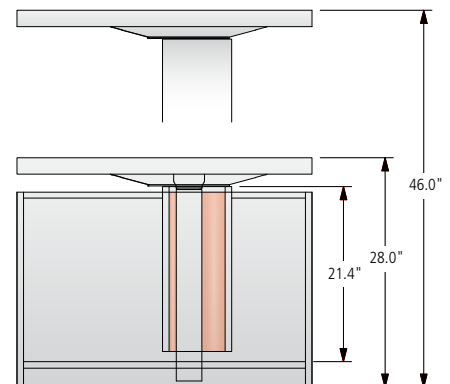
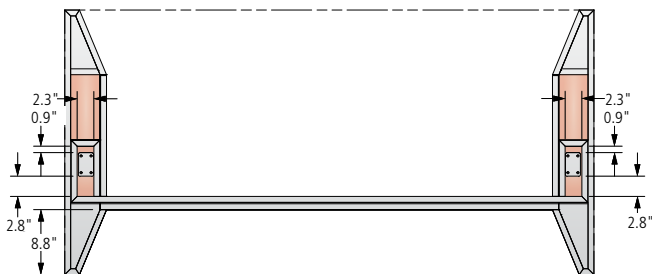



DESK WITH ADJUSTABLE HEIGHT PENINSULA BASE

PROGRAMMABLE CONTROLLER

The programmable controller features up/down buttons, four programmable preset stops, and a digital readout that displays the worksurface height.

RECOMMENDED ACCESSORIES

- Freestanding Storage Pedestal (page 80)
- Plug Strip (page 84)

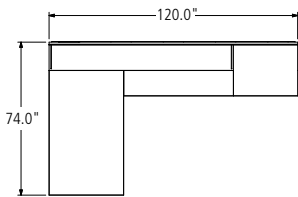
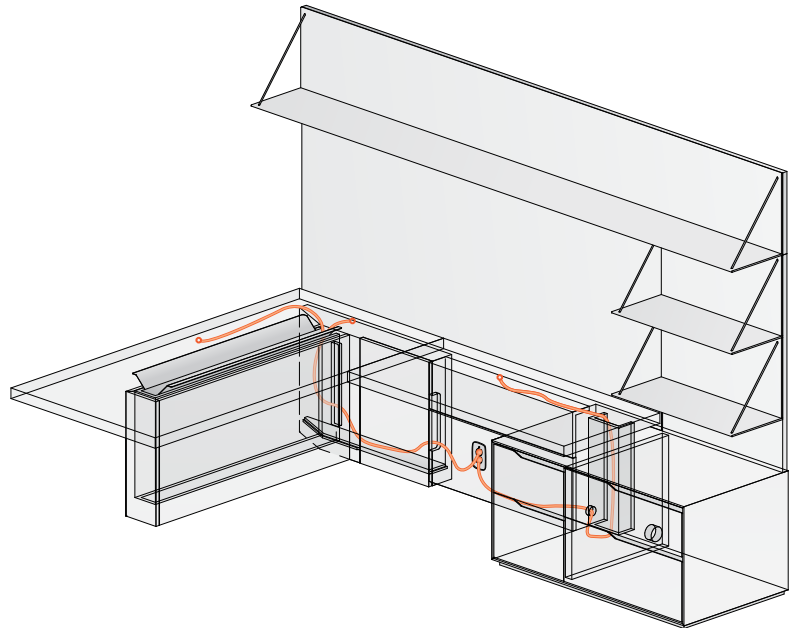

TYPICAL ASC-01-L

COMPONENT	MODEL #	DIMENSIONS	DESCRIPTION	PRICE
Work Surface	AASD-3672-V	36 x 72	Desk Work Surface	4,608
Height Adjustable Support	AAH-APN-3672-V-L	36 x 72	Height Adjustable Peninsula Base	5,621
Access Panel	AAAP-AH-36-V	36	Height Adjustable Access Panel	1,705
Work Surface	AAR-2454-V	24 x 54	Return Work Surface	3,313
Height Adjustable Support	AAH-MF-4826-S-L	26 x 48	Height Adjustable Multi File Support (18" and 30" Box Box File)	8,094
Integrated Pull	-MIP		Integrated Pull with Metal Accent	-
Overhead Shelf	AAOW-AM-120S-V	120	Ascari Series Single Metal Shelf with Veneer Back Panel	9,402
Wall Panel	AAGB-9044	90 x 44.5	Magnetic Glass Wall Panel- single overhead	6,172
Ascari Storage Shelves	AAS2-3044-V	30 x 44.5	Ascari Series Double Stacked 36" w Metal Storage Shelves with Veneer Wall Panel	2,311
Lift Controller	AALIFT-3		3-Lift Controller Box and Cables	-

Private Office List Price: \$41,226

PENINSULA BASE WIRE MANAGEMENT

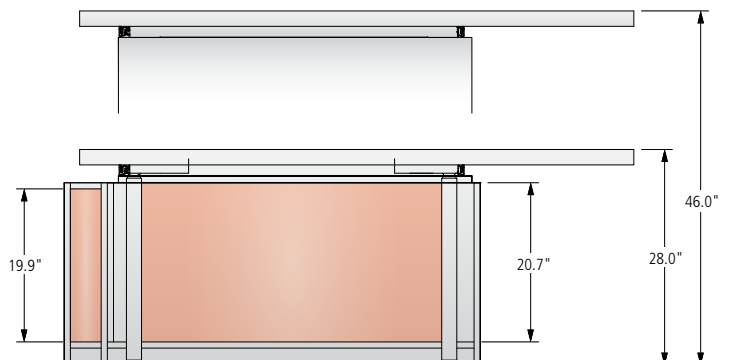
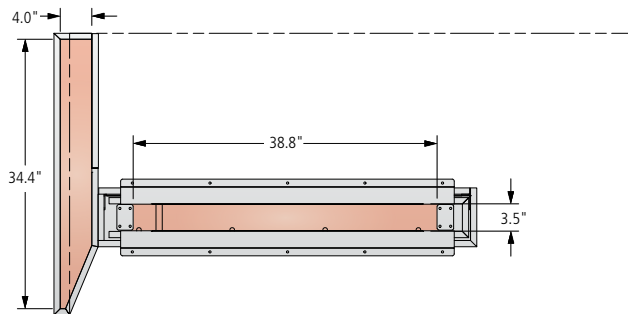



ADJUSTABLE HEIGHT DESK WITH COMMON CASE SUPPORT

PROGRAMMABLE CONTROLLER

The programmable controller features up/down buttons, four programmable preset stops, and a digital readout that displays the worksurface height.

RECOMMENDED ACCESSORIES

- Freestanding Storage Pedestal (page 80)
- Plug Strip (page 84)

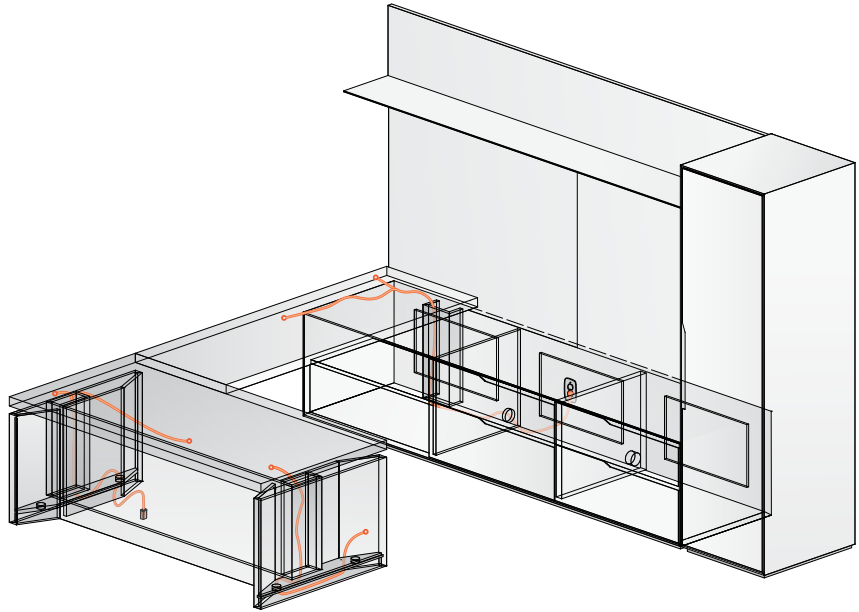
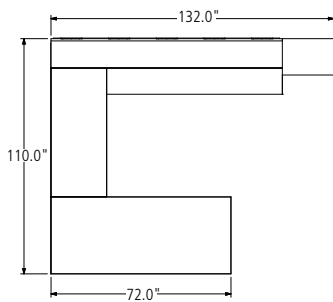

TYPICAL ASC-01-U

COMPONENT	MODEL #	DIMENSIONS	DESCRIPTION	PRICE
Height Adjustable Support	AAAFD-3672-V	36 x 72	Height Adjustable Desk with Lifts Worksurface and Modesty	14,438
Work Surface	AAR-2672-V-XR	26 x 72	Run-off Work Surface	3,405
Low Common Case	AACS-LL-BF-10826-V-L	26 x 108	Height Adjustable Low Common Case with (2) 36" W Box File & (1) 36" W Open Shelf	14,032
Integrated Pull	-MIP		Integrated Pull with Metal Accent	-
Metal Shelf	AAOW-MM-108S-V		Single Metal Shelf with Veneer Back Panel	8,615
Wall Panel	AATB-10844-COM	108 x 44.5	Fabric Wall Panel	1,487
Tower	AAFW-2426-84-V-R	24 x 84	Wardrobe with Upper Shelf	8,553
Integrated Pull	-MIP		Integrated Pull with Metal Accent	-
Lift Controller	AALIFT-3		3-Lift Controller Box and Cables	-

Private Office List Price: \$50,530

PANEL BASE WIRE MANAGEMENT

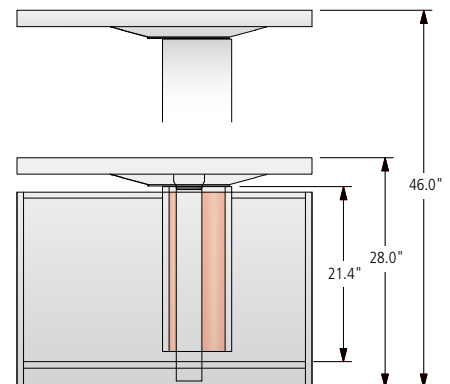
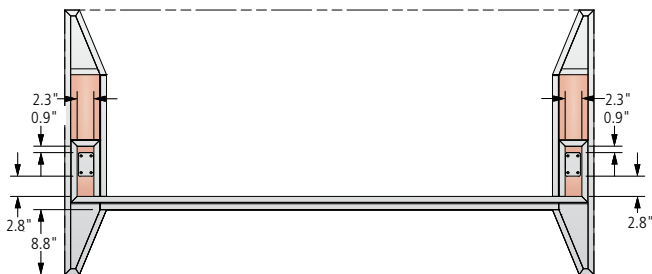



DESK WITH ADJUSTABLE HEIGHT BOOKCASE SUPPORT

PROGRAMMABLE CONTROLLER

The programmable controller features up/down buttons, four programmable preset stops, and a digital readout that displays the worksurface height.

RECOMMENDED ACCESSORIES

- Freestanding Storage Pedestal (page 80)
- Plug Strip (page 84)

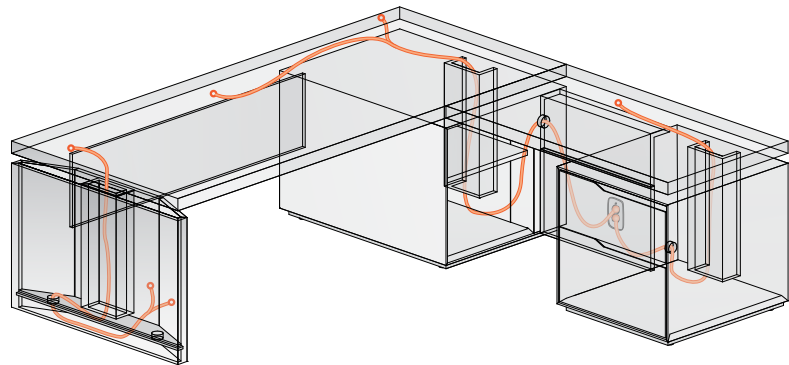
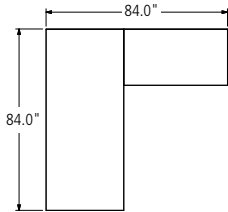

TYPICAL ASC-02-L

COMPONENT	MODEL #	DIMENSIONS	DESCRIPTION	PRICE
Work Surface	AASD-3684-V	36 x 84	Desk Work Surface	5,248
Height Adjustable Support	AAH-APL-36-V-L	36 x 5	Height Adjustable Faceted Panel Leg	3,510
Height Adjustable Support	AAH-BC-36-V-R	36 x 26	Height Adjustable Bookcase Corner Support	3,627
Modesty	MP-BC-F-84-V	12 x 48.31	1/2 Height Modesty	2,176
Work Surface	AAR-2648-V	26 x 48	Run off Credenza Work Surface	2,328
Access Panel	AAAP-AH-24-V	24	Height Adjustable Access Panel	1,532
Height Adjustable Support	AAH-BF-2426-V	26 x 24	Height Adjustable Box File Pedestal	6,783
Integrated Pull	-MIP		Integrated Pull with Metal Accent	-
Lift Controller	AALIFT-3		3-Lift Controller Box and Cables	-

Private Office List Price: \$25,204

BOOKCASE WIRE MANAGEMENT

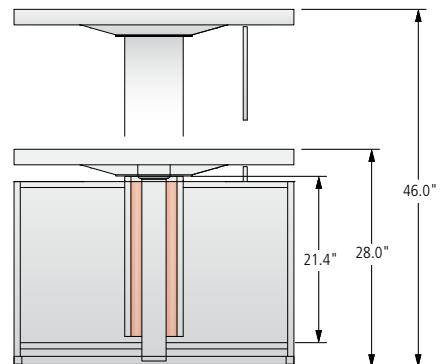
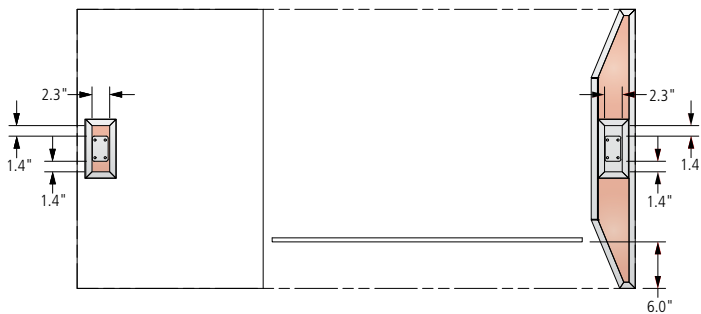



FREESTANDING DESK AND ADJUSTABLE HEIGHT BACK CREDENZA

PROGRAMMABLE CONTROLLER

The programmable controller features up/down buttons, four programmable preset stops, and a digital readout that displays the worksurface height.

RECOMMENDED ACCESSORIES

- Freestanding Storage Pedestal (page 80)
- Plug Strip (page 84)
- Pencil Drawer (page 84)

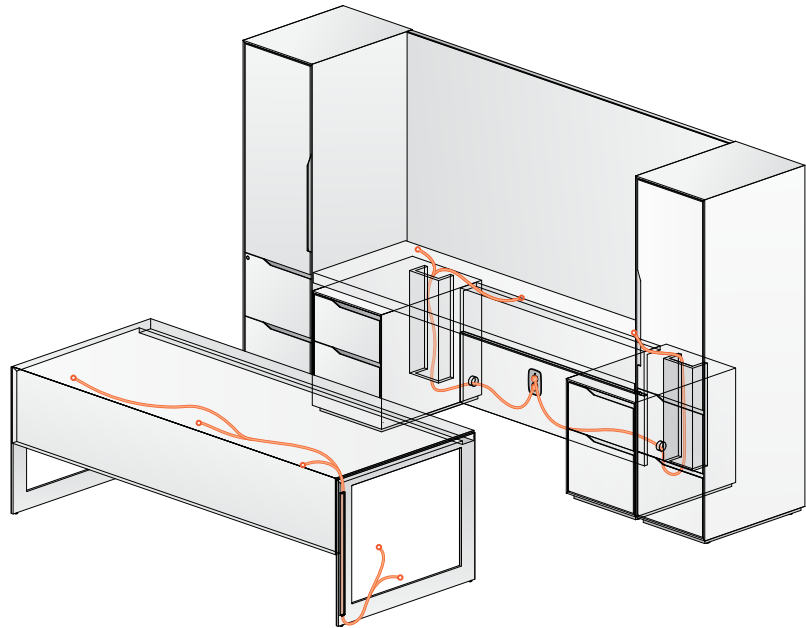
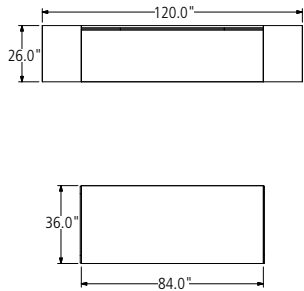

TYPICAL ASC-02-F

COMPONENT	MODEL #	DIMENSIONS	DESCRIPTION	PRICE
Static Freestanding Desk	AAHD-3684-V	36 x 84	Desk Work Surface, Mitered Modesty, and (2) Hoop Bases	11,113
Tower	AAFF-1826-68-V-L	18 x 26	File/ File with Upper Door Wardrobe	8,428
Integrated Pull	-WIP		Integrated Pull with Wood Accent	-
Work Surface	AAC-2484-V-TT	24 x 84	Credenza Work Surface	4,514
Height Adjustable Support	AAH-BF-1826-S	18 x 26	Adjustable Height Box File Support	6,277
Integrated Pull	-WIP		Integrated Pull with Wood Accent	-
Access Panel	AAAP-AH-48-V	48	Height Adjustable Access Panel	1,705
Height Adjustable Support	AAH-BF-1826-S	18 x 26	Adjustable Height Box File Support	6,277
Integrated Pull	-WIP		Integrated Pull with Wood Accent	-
Wall Panel	AAGB-8444	84 x 44	Magnetic Glass Wall Panel	5,761
Tower	AAFF2-1826-68-V-R	18 x 26	File/ File with Upper Door Wardrobe	8,778
Integrated Pull	-WIP		Integrated Pull with Wood Accent	-
Lift Controller	AALIFT-2		2-Lift Controller Box and Cables	-

Private Office List Price: \$52,853

WIRE MANAGEMENT

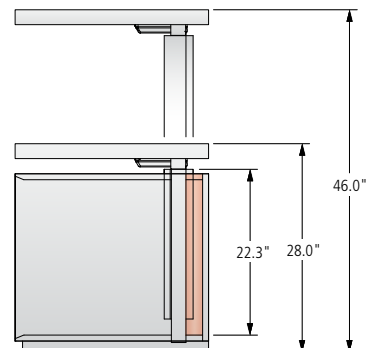
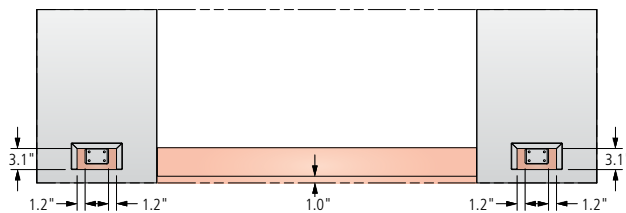



RUN-OFF DESK WITH LOW COMMON CASE CREDENZA SUPPORT

PROGRAMMABLE CONTROLLER

The programmable controller features up/down buttons, four programmable preset stops, and a digital readout that displays the worksurface height.

RECOMMENDED ACCESSORIES

- Freestanding Storage Pedestal (page 80)
- Plug Strip (page 84)
- Pencil Drawer (page 84)

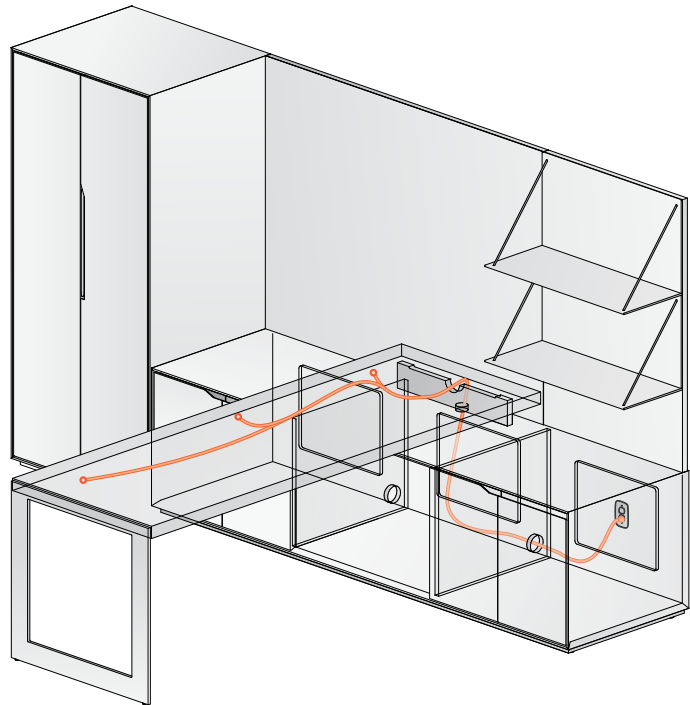
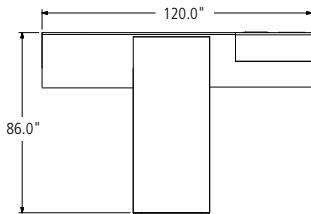

TYPICAL ASC-02-T

COMPONENT	MODEL #	DIMENSIONS	DESCRIPTION	PRICE
Work Surface	AASD-3084-V-XL	30 x 84	Run Off Desk Work Surface	4,495
Support	AAHL-30-L	30 x .5	Hoop Leg without Modesty Hardware	1,805
Spacer Leg	AASP-30-V		Spacer Leg	196
Tower	AAFW-3026-68-V-L	30 x 68	Wardrobe with (5) Adjustable Shelves	9,342
Integrated Pull	-MIP		Integrated Pull with Metal Accent	-
Low Common Case	AACS-T-DD-9026-V	90 x 26	Low Common Case Support (2) 30"w Double Door Units & (1) 30"w Open Shelf	9,878
Integrated Pull	-MIP		Integrated Pull with Metal Accent	-
Wall Panel	AAVB-6044	60 x 44.5	Magnetic Veneer Wall	3,260
Ascari Storage Shelves	AAS2-3044-V	30 x 44.5	Ascari Series Double Stacked 30"w Metal Storage Shelves with Veneer Wall Panel	2,311

Private Office List Price: \$31,287

CREDENZA SUPPORT WIRE MANAGEMENT

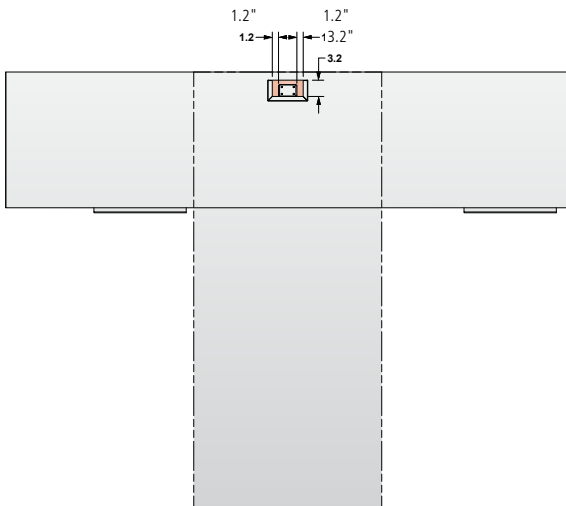



RUN-OFF DESK ADJUSTABLE HEIGHT COMMON CASE AND CREDENZA

PROGRAMMABLE CONTROLLER

The programmable controller features up/down buttons, four programmable preset stops, and a digital readout that displays the worksurface height.

RECOMMENDED ACCESSORIES

- Freestanding Storage Pedestal (page 80)
- Plug Strip (page 84)
- Pencil Drawer (page 84)

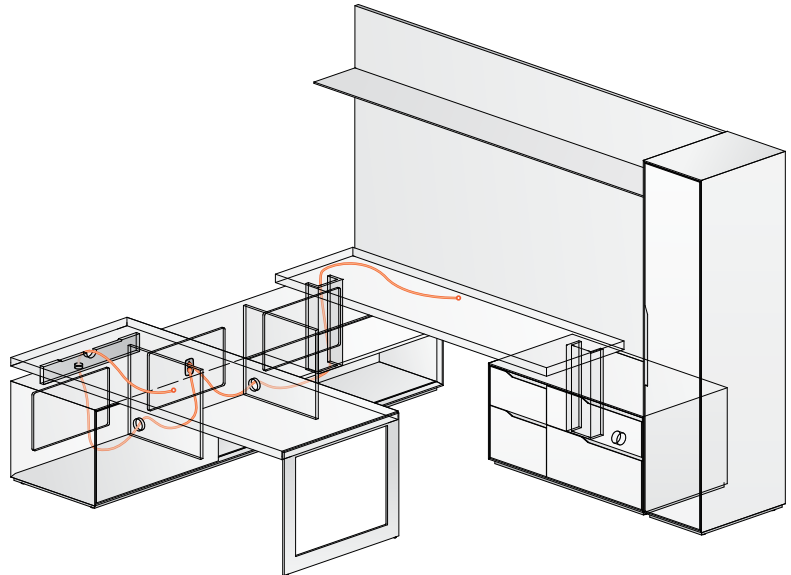
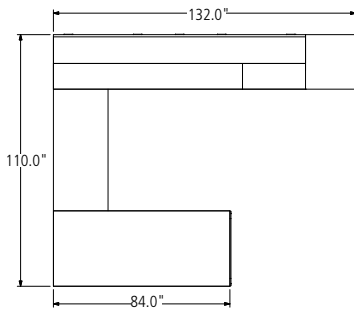

TYPICAL ASC-02-U

COMPONENT	MODEL #	DIMENSIONS	DESCRIPTION	PRICE
Work Surface	AASD-3684-V-XL	36 x 84	Run Off Work Surface	5,248
Support	AAHL-36-L	36 x .5	Metal Hoop Leg Desk without Modesty Hardware	2,029
Common Case Credenza	AACS-LL-SD-10826-V-R	108 x 26	Height Adjustable Common Case (2) 36" w Open Shelves with (1) 36" w Sliding Door	14,032
Spacer Leg	AASP-36-V		Spacer Leg	196
Work Surface	AAC-2484-V	26 x 84	Credenza Work Surface	4,514
Height Adjustable Support	AAH-MF-4826-V-L	48 x 26	Height Adjustable Multi File with Lift Support (18" and 30" Box Box File)	8,432
Shelf	AAOW-WW-1145-V	114 x 15	Single Wood Shelf	7,138
Wall Panel	AAGB-11444	114 x 44.5	Magnetic Glass Wall Panel	7,155
Tower	AAFV-1826-84-V-R	24 x 84	Wardrobe with Upper Shelf	7,334
Integrated Pull	-MIP		Integrated Pull with Metal Accent	-
Lift Controller	AALIFT-2		2-Lift Controller Box and Cables	-

Private Office List Price: \$56,078

WALL SUPPORT WIRE MANAGEMENT

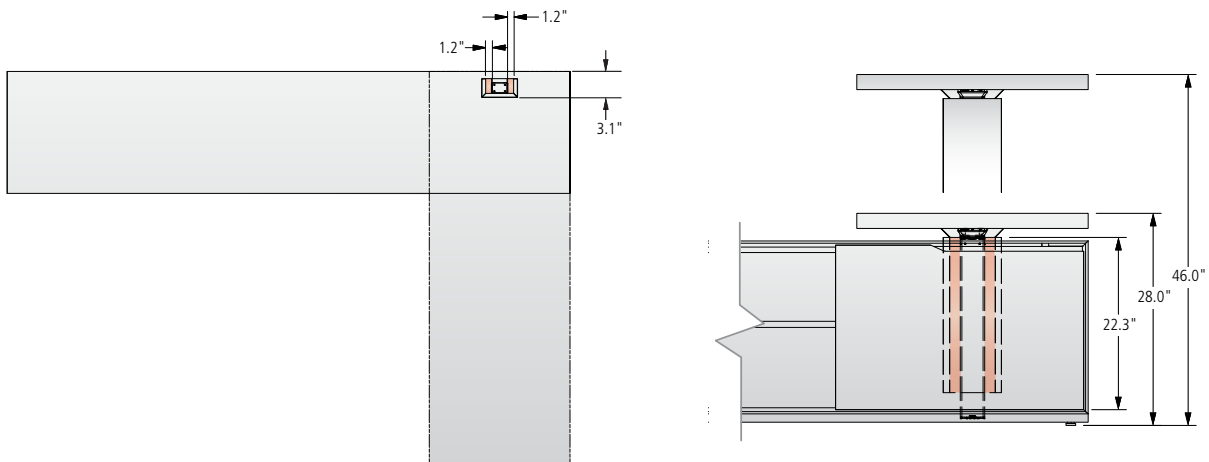



HEIGHT ADJUSTABLE CREDENZA AND RETURN WORK SURFACE

PROGRAMMABLE CONTROLLER

The programmable controller features up/down buttons, four programmable preset stops, and a digital readout that displays the worksurface height.

RECOMMENDED ACCESSORIES

- Freestanding Storage Pedestal (page 80)
- Plug Strip (page 84)

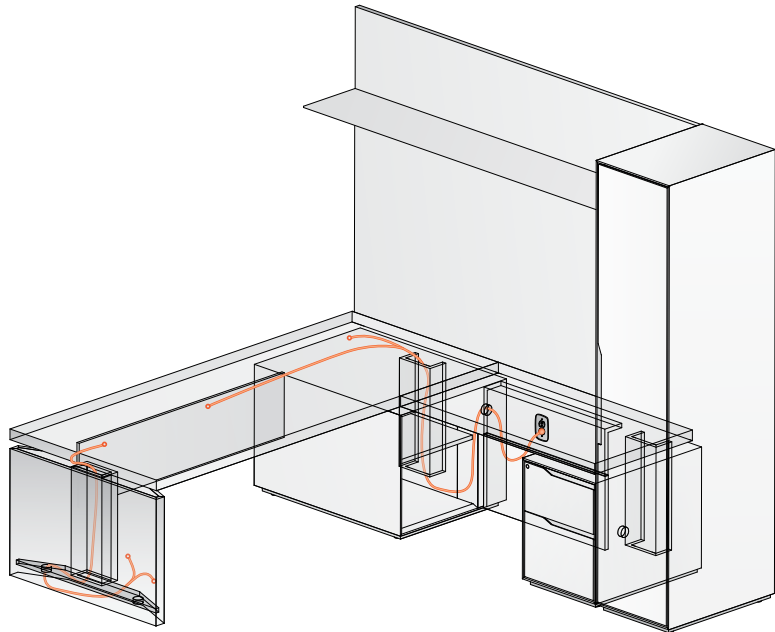
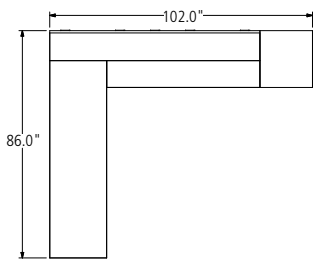

TYPICAL ASC-02-M

COMPONENT	MODEL #	DIMENSIONS	DESCRIPTION	PRICE
Work Surface	AASD-3684-V-XR	36 x 84	Desk Work Surface	5,248
Height Adjustable Support	AAH-APL-36-V-L	36 x 5	Height Adjustable Faceted Panel Base	3,510
Height Adjustable Support	AAH-BC-36-V	36 x 26	Height Adjustable Bookcase Corner Support	3,627
Modesty	MP-BC-F-84-V	48.3	1/2 Height Modesty Panel	2,176
Work Surface	AAR-2448-V-T	24 x 48	Run Off Work Surface	3,061
Access Panel	AAAP-AH-30-V	30	Height Adjustable Access Panel	1,532
Height Adjustable Support	AAH-BF-1826-V	26 x 18	Height Adjustable Box/ File Support	6,536
Integrated Pull	-MIP		Integrated Pull with Metal Accent	-
Shelf	AAOW-MM-84S-V	84 x 15.5	Single Metal Shelf	7,388
Wall Panel	AAVB-8441	84 x 41	Magnetic Veneer Wall Panel	3,958
Tower	AAFW-1826-84-V	18 x 84	Wardrobe with Upper Shelf	7,334
Integrated Pull	-MIP		Integrated Pull with Metal Accent	-
Lift Controller	AALIFT-3		3-Lift Controller Box and Cables	-

Private Office List Price: \$44,370

CREDENZA SUPPORT WIRE MANAGEMENT

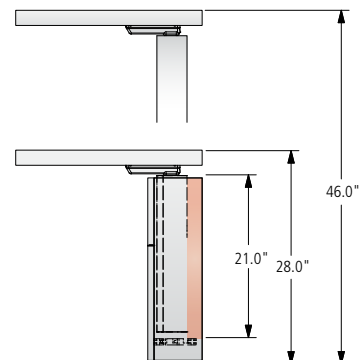
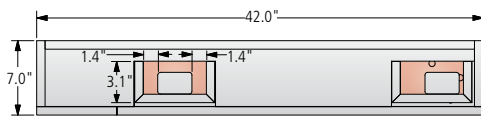



MEETING TABLE AND CREDENZA

PROGRAMMABLE CONTROLLER

The programmable controller features up/down buttons, four programmable preset stops, and a digital readout that displays the worksurface height.

RECOMMENDED ACCESSORIES

- Freestanding Storage Pedestal (page 80)
- Plug Strip (page 84)

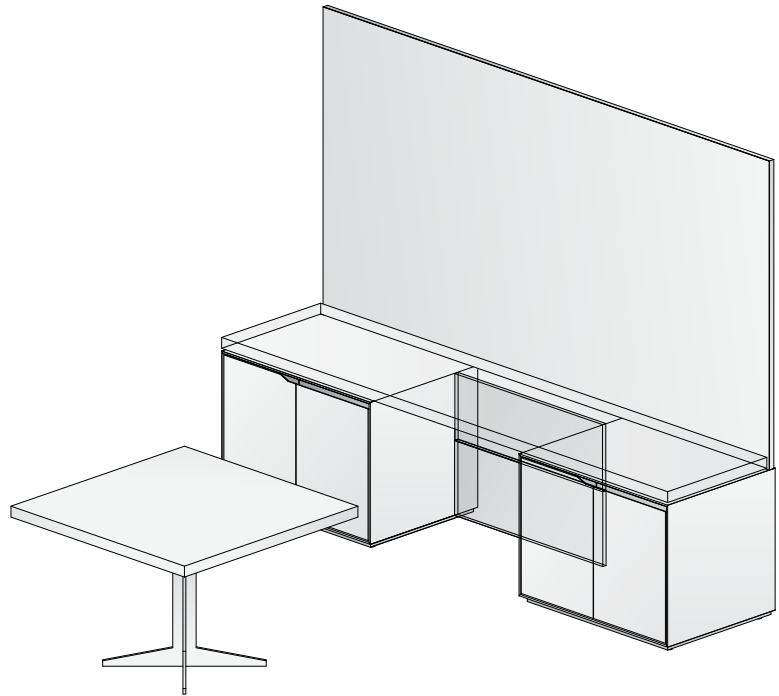
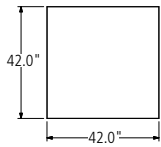
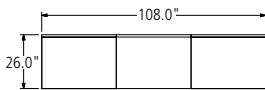

TYPICAL ASC-01-M

COMPONENT	MODEL #	DIMENSIONS	DESCRIPTION	PRICE
Meeting Table	AASQ-XC-42-V	42 x 42	Square Meeting Table with Column Base	5,250
Work Surface	AAC-24108-V	108 X 24	Veneer Credenza Work Surface	4,981
Support	AADD-3626-V	36 X 26	Double Door Storage Pedestal	4,701
Integrated Pull	-WIP		Integrated Pull with Wood Accent	-
Access Panel	AAAP-S-36-V	36	Static Access Panel	1,474
Support	AADD-3626-V	36 X 26	Double Door Storage Pedestal	4,701
Integrated Pull	-WIP		Integrated Pull with Wood Accent	-
Wall Panel	AAVB-10860	108 x 60	Veneer Back Wall	5,232
Grommet	-WPRC		2" Grommet	167

Private Office List Price: \$26,506



RUN-OFF DESK WITH LOW COMMON CASE CREDENZA

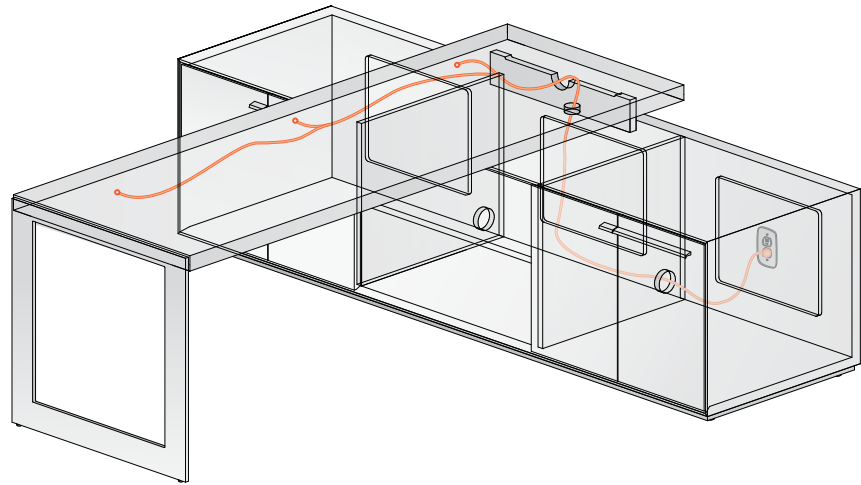
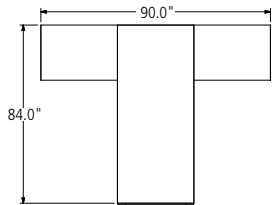

TYPICAL ASC-03-T

COMPONENT	MODEL #	DIMENSIONS	DESCRIPTION	PRICE
Work Surface	AARO-3084-V-L	30 x 84	Run Off Work Surface	4,495
Support	AAHL-30-L	30 x .5	Hoop Leg without Modesty Hardware	1,805
Spacer Leg	AASP-30-V	30	Spacer Leg	196
Low Common Case	AACC-T-DD-9026-V	90 x 26	Low Common Case with (2) 30" w Double Door Units & (1) 30" w Open Shelf	10,175
Metal Tab Pull	-MP		Metal Tab Pull	-

Private Office List Price: \$16,671



ASCARI CASEGOOD PLANNING GUIDE



SHALLOW-DEPTH TOWERS (ALIGN WITH OVERHEAD)

Single Door Wardrobe Tower:

- Hatshef above wardrobe bar is fixed
- Wardrobe bar runs front to back behind valance
- Optional mirror does not ship installed

Double Door Storage Tower:

- Lock option includes two locks, one per door, 35" High
- 68"h includes one fixed shelf, three adjustable shelves and can accept one additional set of adjustable shelves
- 84"h includes one fixed shelf, four adjustable shelves and can accept one additional set of adjustable shelves
- Side panels of tower are pre bored with 12 locations for optional shelf placement above and below the fixed shelf
- Optional mirror does not ship installed

68" and 84" Shallow-Depth Towers



68" Single Door Wardrobe Tower

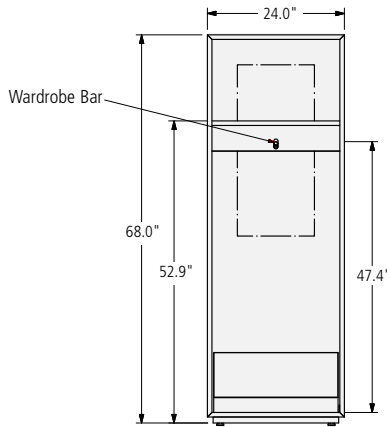

AAFW-2417-68

68" Double Door Storage Tower

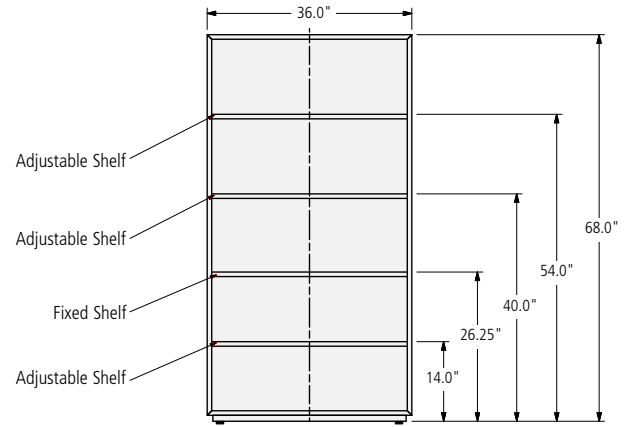

AABC-D-3617-68

84" Single Door Wardrobe Tower

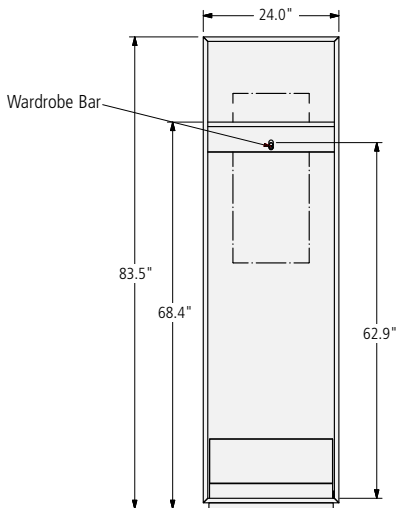

AAFW-2417-84

84" Double Door Storage Tower

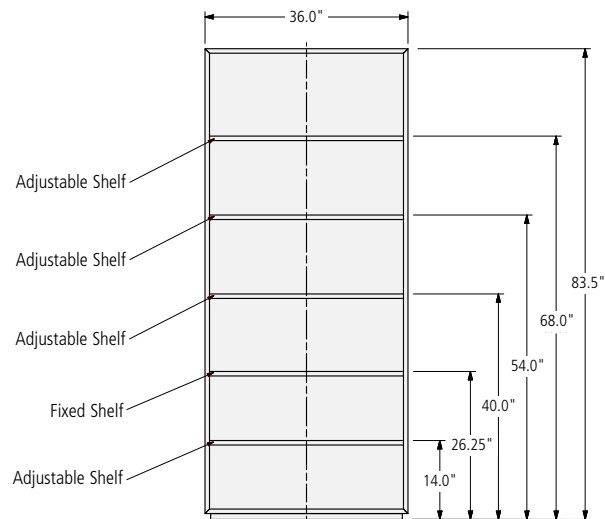

AABC-D-3617-84



FULL-DEPTH TOWERS (ALIGN WITH WORK SURFACE DEPTH)

- Double Door Tower is field reversible
- Double Door Towers include 3 adjustable shelves
- Optional mirror does not ship installed
- Hatshelf above wardrobe bar is fixed
- Double Door Lock option includes two locks, one per door, 35" High

68" and 84" Full-Depth Towers

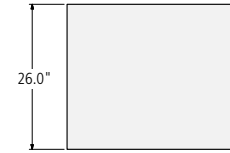

68" Single Door Tower

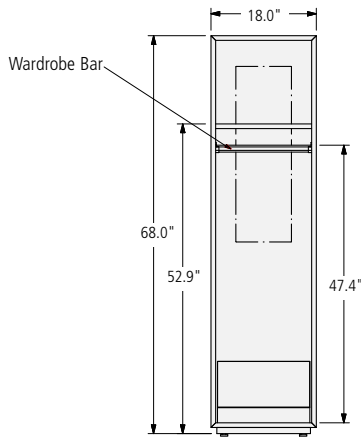

AAFW-1826-68

68" Double Door Tower

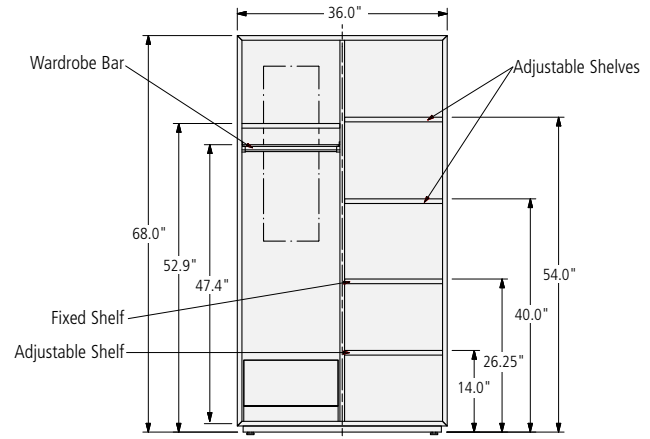

AAFW-3626-68-L

84" Single Door Tower

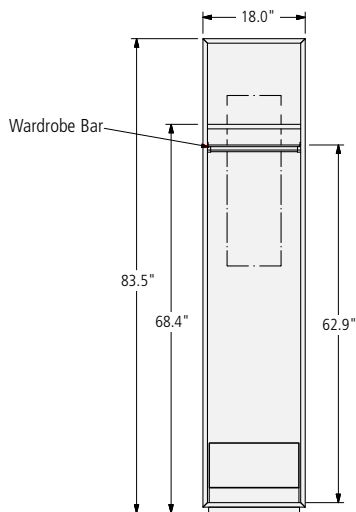

AAFW-1826-84

84" Double Door Tower

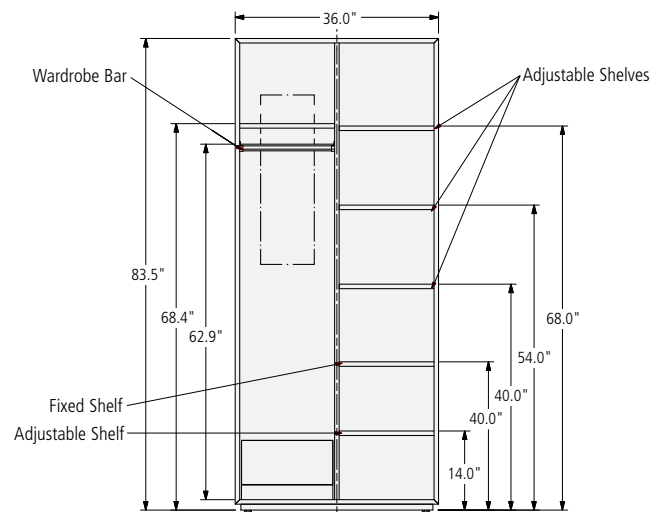

AAFW-3626-84-L



WORK SURFACE POWER OPTIONS

GROMMET

- Grommet is 2" diameter
- Available in Powder coat, Clear Anodized and Polished
- Height adjustable Bridges, Returns, and Credenzas are available with center grommet location only
- Grommets are included as an option within each work surface
- Grommets may not be placed directly over the end panel of a support pedestal below
- Only one Grommet or Spec may be specified per work surface

Freestanding Desks, Run-Off Desks, Hoop Run-Off Desks

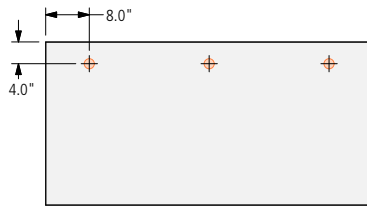

24"-Deep Credenzas

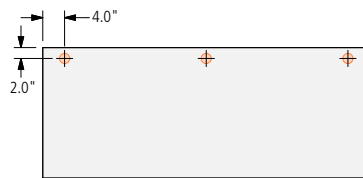

26"-Deep Credenzas

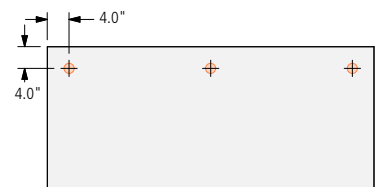

GROMMETS ON COMMON CASES

- When a grommet is specified on a common case, the grommet will be over the open bay of the case. The case will include a false back with wire management and access to the architectural wall.
- Wires can be routed through the open shelf location and into the back panel cavity of a common case when a grommet is specified on a run off work surface above or in alignment with the common case.

Freestanding Hoop Hoop Desk

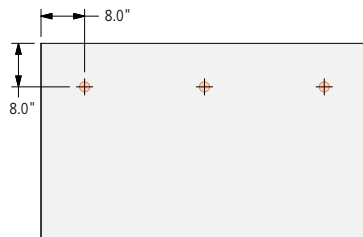

POWER SPEC AND USB SPEC

This compact unit allows for the addition of power or data to a work surface in a discreet way. Available in round or square shapes, and multiple finish options.

- Power or USB Spec is a work surface accessory, specified in addition to the work surface.
- Only one Grommet or Spec may be specified per work surface
- Power or USB Spec may not be placed directly over the end panel of a support pedestal below

Power Spec

- Spill-proof power simplex
- Compact design
- 1-3/4" cutout for installation
- UL Listed

Power Spec

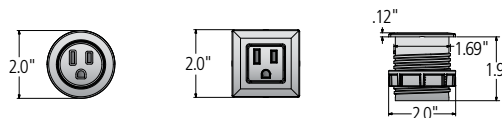

USB Spec

- Used to charge devices or transfer data
- Compact design
- Offered with USB-A+C
- 1-3/4" cutout
- UL Listed

USB Spec

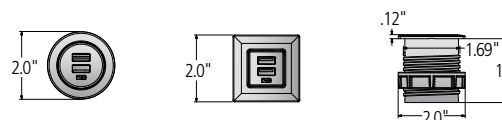



FREESTANDING POWER OPTION: TECH ZONE

TECH ZONE

Simple, easy to use and portable, this freestanding table top power option allows you to easily charge all of your devices.

Available in two configurations with a variety of power and data connectivity options. Includes a 72"-long plug-in infeed cord.

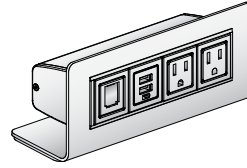

Tech Zone - Side View

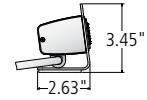

ZONE-USB-C

Includes two simplex receptacles, one data port and one charging USB-A+C charging port

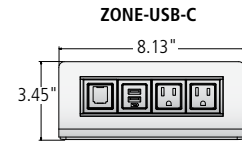

ZONE-DATA

Includes two simplex receptacles and two open data ports

ZONE-DATA





ASCARI CASEGOOD PRICE LIST



HOOP-HOOP FREESTANDING DESK WITH WATERFALL MODESTY

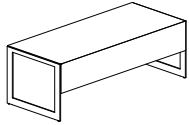

FREESTANDING

SURFACE MATERIAL KEY

V Veneer

FREESTANDING WORK SURFACE

MODEL #	DEPTH	WIDTH	DESCRIPTION	-V
AAHD-3060	30	60	Desk Work Surface, Mitered Modesty, (2) Hoop Bases	8,755
AAHD-3066	30	66	Desk Work Surface, Mitered Modesty, (2) Hoop Bases	9,057
AAHD-3072	30	72	Desk Work Surface, Mitered Modesty, (2) Hoop Bases	9,351
AAHD-3078	30	78	Desk Work Surface, Mitered Modesty, (2) Hoop Bases	9,636
AAHD-3084	30	84	Desk Work Surface, Mitered Modesty, (2) Hoop Bases	9,917
AAHD-3660	36	60	Desk Work Surface, Mitered Modesty, (2) Hoop Bases	9,795
AAHD-3666	36	66	Desk Work Surface, Mitered Modesty, (2) Hoop Bases	10,140
AAHD-3672	36	72	Desk Work Surface, Mitered Modesty, (2) Hoop Bases	10,479
AAHD-3678	36	78	Desk Work Surface, Mitered Modesty, (2) Hoop Bases	10,804
AAHD-3684	36	84	Desk Work Surface, Mitered Modesty, (2) Hoop Bases	11,113



OPTIONS

OPTIONS	CODE	PRICE	NOTES
Polished Chrome Hoop Legs:	-PC	\$3,555	For (2) Hoop Legs
2"-Diameter Grommet Options:			
Center Grommet	-WPRC	\$234	
Left Grommet	-WPRL	\$234	
Right Grommet	-WPRR	\$234	
Left and Right Grommet	-WPR2	\$465	
Polished Chrome Grommet	-PCG	\$98	per Grommet
Power Spec / USB Spec Options:			
Center Unit	-SP-C		Please Note: Power Spec and USB Spec are specified separately. See page 83.
Left Unit	-SP-L		
Right Unit	-SP-R		
Left and Right Units	-SP-LR		

GENERAL INFORMATION

- Veneer species often dictates cut; default veneer cut is flat
- Work surface height: 29-1/2"
- Work surface is 2"-thick with square edge profile
- Work surface tops will be grain-matched sets based on configuration
- Grommets available in Powder Coat, Clear Anodized, and Polished Chrome (upcharge applies)
- Modesty is 3/4 height
- Power Spec and USB Spec specified separately. See page 83.

REQUIRED INFORMATION (ORDER CANNOT BE ENTERED WITHOUT THIS INFORMATION)

See appendix pages vi-viii for surface material options.

- Choose Veneer Finish, if applicable
- Choose Metal Finish, if applicable
- Choose Paint Finish, if applicable



DESK: WORK SURFACE

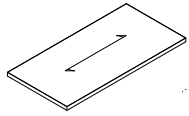

WORK SURFACE

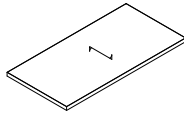

RUN-OFF

SURFACE MATERIAL KEY

V Veneer

WORK SURFACE: FREESTANDING // SINGLE PEDESTAL // RUN-OFF WITH LOW CREDENZA (L-SHAPE AND U-SHAPE)

MODEL #	DEPTH	WIDTH	DESCRIPTION	-V
AASD-3060	30	60	Desk Work Surface	3,333
AASD-3066	30	66	Desk Work Surface	3,637
AASD-3072	30	72	Desk Work Surface	3,930
AASD-3078	30	78	Desk Work Surface	4,215
AASD-3084	30	84	Desk Work Surface	4,495
AASD-3660	36	60	Desk Work Surface	3,930
AASD-3666	36	66	Desk Work Surface	4,275
AASD-3672	36	72	Desk Work Surface	4,608
AASD-3678	36	78	Desk Work Surface	4,936
AASD-3684	36	84	Desk Work Surface	5,248

RUN-OFF: L-SHAPE, T-SHAPE AND U-SHAPE

MODEL #	DEPTH	WIDTH	DESCRIPTION	-V
AARO-3048	30	48	Desk Work Surface	2,670
AARO-3054	30	54	Desk Work Surface	3,003
AARO-3060	30	60	Desk Work Surface	3,333
AARO-3066	30	66	Desk Work Surface	3,637
AARO-3072	30	72	Desk Work Surface	3,930
AARO-3078	30	78	Desk Work Surface	4,215
AARO-3084	30	84	Desk Work Surface	4,495
AARO-3648	36	48	Desk Work Surface	3,140
AARO-3654	36	54	Desk Work Surface	3,531
AARO-3660	36	60	Desk Work Surface	3,930
AARO-3666	36	66	Desk Work Surface	4,275
AARO-3672	36	72	Desk Work Surface	4,608
AARO-3678	36	78	Desk Work Surface	4,936
AARO-3684	36	84	Desk Work Surface	5,248

If using a single Hoop support with a Run-Off Desk **-HL or -HR** No Charge "L" and "R" designates Left or Right relative to the user

If using a Height Adjustable support against a work wall **-XL or -XR** No Charge "L" and "R" designates Left or Right relative to the user



DESK: WORK SURFACE



OPTIONS	CODE	PRICE	NOTES
2"-Diameter Grommet Options:			
Center Grommet	-WPRC	\$234	
Left Grommet	-WPRL	\$234	
Right Grommet	-WPRR	\$234	
Left and Right Grommet	-WPR2	\$465	
Polished Chrome Grommet	-PCG	\$98	per Grommet
Power Spec / USB Spec Options:			
Center Unit	-SP-C		Please Note: Power Spec and USB Spec are specified separately. See page 83.
Left Unit	-SP-L		
Right Unit	-SP-R		
Left and Right Units	-SP-LR		

GENERAL INFORMATION

- Veneer species often dictates cut; default veneer cut is flat
- Work surface is 2"-thick with square edge profile
- Grain direction on work surfaces should always run parallel to a seam
- Work surface tops will be grain-matched sets based on configuration
- Grommets available in Powder Coat, Clear Anodized, and Polished Chrome (upcharge applies)
- Power Spec and USB Spec specified separately. See page 83.

REQUIRED INFORMATION (ORDER CANNOT BE ENTERED WITHOUT THIS INFORMATION)

See appendix pages vi-viii for surface material options.

- Choose Veneer Finish, if applicable
- Choose Metal Finish, if applicable
- Choose Paint Finish, if applicable



DESK SUPPORTS: STATIC

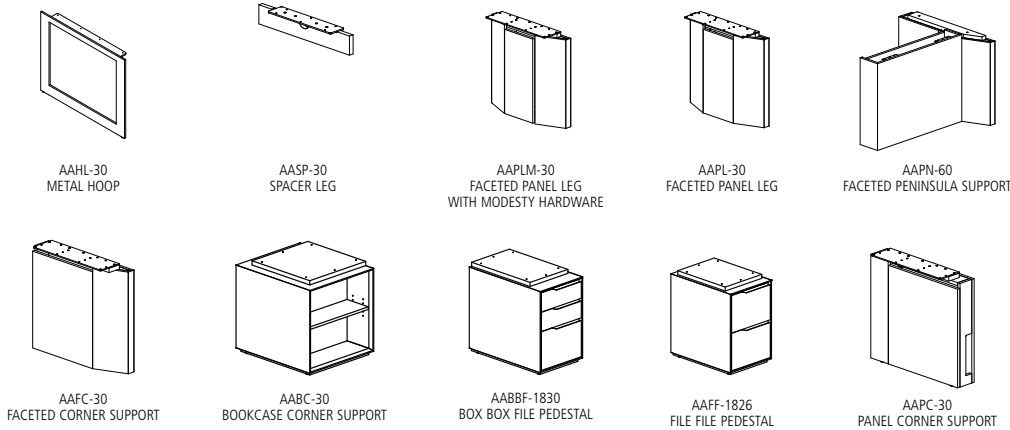

SURFACE MATERIAL KEY

- S All Paint
- V Veneer
- VS Veneer Case and Painted Front

DESK SUPPORTS

MODEL #	DEPTH	WIDTH	DESCRIPTION	PRICE	-S	-V	-VS
AAHL-30-[]	30	0.5	Metal Hoop Leg without Modesty Hardware	1,805	-	-	-
AAHL-36-[]	36	0.5	Metal Hoop Leg without Modesty Hardware	2,029	-	-	-
AASP-30	30		Spacer Leg (Low Cred Applications)		188	196	-
AASP-36	36		Spacer Leg (Low Cred Applications)		188	196	-
AAPLM-30-[]	30	5	Faceted Panel Leg with Modesty Hardware	1,786	1,881	-	-
AAPLM-36-[]	36	5	Faceted Panel Leg with Modesty Hardware	2,009	2,113	-	-
AAPL-30-[]	30	5	Faceted Panel Leg without Modesty Hardware	1,716	1,805	-	-
AAPL-36-[]	36	5	Faceted Panel Leg without Modesty Hardware	1,927	2,029	-	-
AAPN-3660-[]	60		Faceted Peninsula Support	3,570	3,757	-	-
AAPN-3666-[]	66		Faceted Peninsula Support	3,793	3,990	-	-
AAPN-3672-[]	72		Faceted Peninsula Support	4,012	4,223	-	-
AAPN-3678-[]	78		Faceted Peninsula Support	4,232	4,454	-	-
AAPN-3684-[]	84		Faceted Peninsula Support	4,453	4,689	-	-
AAFC-30-[]	30	5	Faceted Corner Support	1,716	1,805	-	-
AAFC-36-[]	36	5	Faceted Corner Support	1,927	2,029	-	-
AABC-30-[]	30	26	Bookcase Corner Support	1,888	1,987	-	-
AABC-36-[]	36	26	Bookcase Corner Support	2,117	2,229	-	-
AABBF-1526	26	15.5	Box Box File Pedestal	4,525	4,763	4,763	
AABBF-1530	30	15.5	Box Box File Pedestal	5,221	5,497	5,497	
AABBF-1826	26	18	Box Box File Pedestal	4,650	4,897	4,897	
AABBF-1830	30	18	Box Box File Pedestal	5,367	5,648	5,648	
AAFF-1526	26	15.5	File File Pedestal	4,230	4,452	4,452	
AAFF-1530	30	15.5	File File Pedestal	4,880	5,136	5,136	
AAFF-1826	26	18	File File Pedestal	4,349	4,575	4,575	
AAFF-1830	30	18	File File Pedestal	5,017	5,278	5,278	
AAPC-26-[]	26	5	Panel Corner Support	1,487	1,565	-	-
AAPC-30-[]	30	5	Panel Corner Support	1,716	1,805	-	-

[] Specify Left (-L) or Right (-R) relative to the user position



DESK SUPPORTS: STATIC

OPTIONS	CODE	PRICE	NOTES
Polished Chrome Hoop Leg:	-PC	\$1,779	per Hoop Leg
No Locks (Pedestals):	-NL	No Charge	
Pull Options:			
Integrated Pull (Metal Accent)	-MIP	No Charge	
Integrated Pull (Wood Accent)	-WIP	No Charge	
Metal Tab Pull	-MP	No Charge	
Polished Chrome Pulls	-PCP	\$309	per Pull

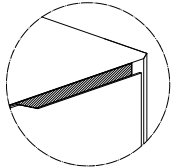

-MIP or -WIP

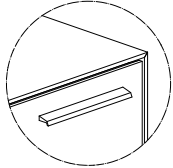

-MP

GENERAL INFORMATION

- Vertical grain direction
- Veneer species often dictates cut, default veneer cut is flat
- Case Height 28"
- Mitered case construction
- Face locking standard on all storage components
- Storage fronts will be grain-matched set
- All lateral, pedestal and box file drawers are standard with white drawer boxes and undermount soft closing slides
- Integrated pull includes a horizontal accent in which a finish must be specified; finish options include veneer, powdercoat, chrome accent, or clear anodized
- If a wood integrated pull (WIP) is selected on a veneer case with painted drawer fronts (VS), the finish of the wood on the integrated pull will default to the veneer of the case unless otherwise specified
- If a wood integrated pull (WIP) is selected on a painted case (S), the finish of the wood on the integrated pull will default to the paint color of the drawer unless otherwise specified
- Metal Tab Pull finish options include powdercoat, chrome, or clear anodized.
- Box drawers include fabric wrapped drawer bottoms. Felt (K1207) or Hopsack (K1206) selection required. If no selection is made, the default choice will be Knoll Felt - Pewter.
- Faceted peninsula base only compatible with 36"-wide work surfaces
- The back of the integrated pull will reflect the wood or metal selection (see shaded area of drawing)
- Spacer leg matches case finish
- Spacer support and pedestals are non handed
- Handedness of the peninsula base is defined by the open end of the work surface - opposite of the position of the base

REQUIRED INFORMATION (ORDER CANNOT BE ENTERED WITHOUT THIS INFORMATION)

- See appendix pages vi-viii for surface material options.
- Choose Veneer Finish, if applicable
 - Choose Metal Finish, if applicable
 - Choose Paint Finish, if applicable
 - Choose Pull option for Pedestals: Integrated Pull (-MIP or -WIP) or Metal Pull (-MP)
 - Choose Fabric option, if applicable



FREESTANDING DESK: ADJUSTABLE HEIGHT PANEL BASE

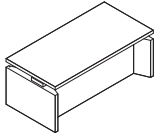

ADJUSTABLE HEIGHT
PANEL BASE

SURFACE MATERIAL KEY

V Veneer

ADJUSTABLE HEIGHT FREESTANDING DESK ASSEMBLY

MODEL #	DEPTH	WIDTH	DESCRIPTION	-V
AAAFD-3060	30	60	Height Adjustable Faceted Panel Legs, Work Surface & Modesty	12,688
AAAFD-3066	30	66	Height Adjustable Faceted Panel Legs, Work Surface & Modesty	12,977
AAAFD-3072	30	72	Height Adjustable Faceted Panel Legs, Work Surface & Modesty	13,254
AAAFD-3078	30	78	Height Adjustable Faceted Panel Legs, Work Surface & Modesty	13,529
AAAFD-3084	30	84	Height Adjustable Faceted Panel Legs, Work Surface & Modesty	13,797
AAAFD-3660	36	60	Height Adjustable Faceted Panel Legs, Work Surface & Modesty	13,794
AAAFD-3666	36	66	Height Adjustable Faceted Panel Legs, Work Surface & Modesty	14,119
AAAFD-3672	36	72	Height Adjustable Faceted Panel Legs, Work Surface & Modesty	14,438
AAAFD-3678	36	78	Height Adjustable Faceted Panel Legs, Work Surface & Modesty	14,751
AAAFD-3684	36	84	Height Adjustable Faceted Panel Legs, Work Surface & Modesty	15,049



OPTIONS

CODE

PRICE

NOTES

2"-Diameter Grommet Options:

Center Grommet	-WPRC	\$234	
Left Grommet	-WPRL	\$234	
Right Grommet	-WPRR	\$234	
Left and Right Grommet	-WPR2	\$465	
Polished Chrome Grommet	-PCG	\$98	per Grommet

Power Spec / USB Spec Options:

Center Unit	-SP-C		Please Note: Power Spec and USB Spec are specified separately. See page 83.
Left Unit	-SP-L		
Right Unit	-SP-R		
Left and Right Units	-SP-LR		

GENERAL INFORMATION

- Vertical grain direction
- Veneer species often dictates cut, default veneer cut is flat
- Work surface height adjustable range of travel 28" - 46"
- Lift mechanisms are designed to support all desk components, plus a maximum of 100lbs additional weight
- Height adjustable lift mechanism is warranted for 2 years
- Grommets available in Powder Coat, Clear Anodized, and Polished Chrome (upcharge applies)
- Work surface is 2"-thick with square edge profile
- Work surface tops will be grain-matched sets based on configuration
- Modesty is full height
- Power Spec and USB Spec specified separately. See page 83.

REQUIRED INFORMATION (ORDER CANNOT BE ENTERED WITHOUT THIS INFORMATION)

See appendix pages vi-viii for surface material options.

- Choose Veneer Finish, if applicable
- Choose Metal Finish, if applicable
- Choose Paint Finish, if applicable
- Choose Pull option for Pedestals: Integrated Pull (-MIP or -WIP) or Metal Pull (-MP)
- Choose Fabric option, if applicable



DESK SUPPORTS: ADJUSTABLE HEIGHT

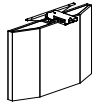

AAH-APL-36
FACETED PANEL LEG
WITH LIFT

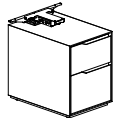

AAH-BF-1826
BOX FILE SUPPORT
WITH LIFT

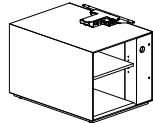

AAH-BC-36
BOOKCASE CORNER
SUPPORT WITH LIFT

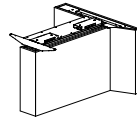

AAH-APN-3660
ADJUSTABLE HEIGHT FACETED
PENINSULA SUPPORT

SURFACE MATERIAL KEY

- S All Paint
- V Veneer
- VS Veneer Case and Painted Front

DESK SUPPORTS

MODEL #	DEPTH	WIDTH	DESCRIPTION	-S	-V	-VS
AAH-APL-30-[]	30	5	Faceted Panel Leg with Lift	3,185	3,278	-
AAH-APL-36-[]	36	5	Faceted Panel Leg with Lift	3,405	3,510	-
AAH-BF-1526-[]	26	15	Box File Support with Lift	5,626	5,850	5,850
AAH-BF-1826	26	18	Box File Support with Lift	6,277	6,536	6,536
AAH-BF-1530-[]	30	15	Box File Support with Lift	6,048	6,297	6,297
AAH-BF-1830	30	18	Box File Support with Lift	6,765	7,046	7,046
AAH-BC-30-[]	30	26	Bookcase Corner Support with Lift	3,283	3,384	-
AAH-BC-36-[]	36	26	Bookcase Corner Support with Lift	3,517	3,627	-
AAH-APN-3660-[]	36	60	Adjustable Height Faceted Peninsula Support	4,968	5,155	-
AAH-APN-3666-[]	36	66	Adjustable Height Faceted Peninsula Support	5,187	5,388	-
AAH-APN-3672-[]	36	72	Adjustable Height Faceted Peninsula Support	5,409	5,621	-
AAH-APN-3678-[]	36	78	Adjustable Height Faceted Peninsula Support	5,629	5,853	-
AAH-APN-3684-[]	36	84	Adjustable Height Faceted Peninsula Support	5,851	6,085	-

[] Specify Left (-L) or Right (-R) relative to the user position

LIFT SUPPORT (MUST BE SPECIFIED)

MODEL #	DESCRIPTION	PRICE
AALIFT-2	Add when there is one Height Adjustable Work Surface	No Charge
AALIFT-3	Add when there are two connected Height Adjustable work surfaces	No Charge

OPTIONS	CODE	PRICE	NOTES
No Locks (Pedestals):	-NL	No Charge	
Pull Options:			
Integrated Pull (Metal Accent)	-MIP	No Charge	
Integrated Pull (Wood Accent)	-WIP	No Charge	
Metal Tab Pull	-MP	No Charge	
Polished Chrome Pulls	-PCP	\$309	per Pull

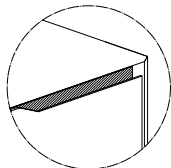

-MIP or -WIP

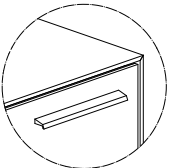

-MP



DESK SUPPORTS: ADJUSTABLE HEIGHT

GENERAL INFORMATION

- Vertical grain direction
- Veneer species often dictates cut, default veneer cut is flat
- Case Height 23-1/2"
- Mitered case construction
- Integrated pull includes a horizontal accent in which a finish must be specified; finish options include veneer, powdercoat, chrome accent, or clear anodized
- If a wood integrated pull (WIP) is selected on a veneer case with painted drawer fronts (VS), the finish of the wood on the integrated pull will default to the veneer of the case unless otherwise specified
- If a wood integrated pull (WIP) is selected on a painted case (S), the finish of the wood on the integrated pull will default to the paint color of the drawer unless otherwise specified
- Metal Tab Pull finish options include powdercoat, chrome, or clear anodized.
- Face locking standard on all storage components
- Storage fronts will be grain-matched set
- All lateral, pedestal and box file drawers are standard with white drawer boxes and undermount soft closing slides
- Door and open shelf storage pedestals include a single adjustable height shelf
- Work surface height adjustable range of travel 28" - 46"
- Lift mechanisms are designed to support all desk components, plus a maximum of 100lbs additional weight
- Height adjustable lift mechanism is warranted for 2 years
- Box drawers include fabric wrapped drawer bottoms. Felt (K1207) or Hopsack (K1206) selection required. If no selection is made, the default choice will be Knoll Felt - Pewter.
- The back of the integrated pull will reflect the wood or metal selection (see shaded area of drawing)
- 15"-wide box file supports are handed
- 18"-wide box file supports are not handed
- Handedness of the peninsula base is defined by the open end of the work surface - opposite of the position of the base

REQUIRED INFORMATION (ORDER CANNOT BE ENTERED WITHOUT THIS INFORMATION)

See appendix pages vi-viii for surface material options.

- Choose Veneer Finish, if applicable
- Choose Metal Finish, if applicable
- Choose Paint Finish, if applicable
- Choose Pull option for Pedestals: Integrated Pull (-MIP or -WIP) or Metal Pull (-MP)
- Choose Fabric option, if applicable



DESK: MODESTY PANEL

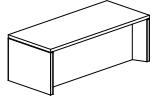

FACETED PANEL - FACETED PANEL
(FULL HEIGHT)

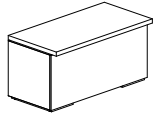

PED-PED
(STATIC FULL HEIGHT)

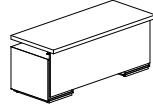

PED-PED
(HEIGHT ADJUSTABLE
FULL HEIGHT)

SURFACE MATERIAL KEY

S All Paint
V Veneer

FREESTANDING DESK

MODEL #	DEPTH	WIDTH	SEAT CLEARANCE WIDTH		DESCRIPTION	-S	-V
FACETED PANEL-FACETED PANEL // FULL HEIGHT MODESTY							
MP-F-60	28.25	58.219	48.6		60" Freestanding Desk Modesty	1,548	1,820
MP-F-66	28.25	64.219	54.6		66" Freestanding Desk Modesty	1,736	2,043
MP-F-72	28.25	70.219	60.6		72" Freestanding Desk Modesty	1,928	2,270
MP-F-78	28.25	76.219	66.6		78" Freestanding Desk Modesty	2,119	2,493
MP-F-84	28.25	82.219	72.6		84" Freestanding Desk Modesty	2,311	2,716
PED-PED // STATIC // FULL HEIGHT MODESTY							
			15.5" PED	18" PED			
MP-P-60	26	60	29	24	60" Freestanding Desk Modesty	1,548	1,820
MP-P-66	26	66	35	30	66" Freestanding Desk Modesty	1,736	2,043
MP-P-72	26	72	41	36	72" Freestanding Desk Modesty	1,928	2,270
MP-P-78	26	78	47	42	78" Freestanding Desk Modesty	2,119	2,493
MP-P-84	26	84	53	48	84" Freestanding Desk Modesty	2,311	2,716
PED-PED // HEIGHT ADJUSTABLE // FULL HEIGHT MODESTY							
			15.5" PED	18" PED			
MPAH-P-60	26	60	29	24	60" Freestanding Desk Modesty	1,548	1,820
MPAH-P-66	26	66	35	30	66" Freestanding Desk Modesty	1,736	2,043
MPAH-P-72	26	72	41	36	72" Freestanding Desk Modesty	1,928	2,270
MPAH-P-78	26	78	47	42	78" Freestanding Desk Modesty	2,119	2,493
MPAH-P-84	26	84	53	48	84" Freestanding Desk Modesty	2,311	-

GENERAL INFORMATION

- Modesty panel required with Freestanding Metal Hoop Leg
- Modesty panel required with Freestanding Faceted Panel Base

REQUIRED INFORMATION (ORDER CANNOT BE ENTERED WITHOUT THIS INFORMATION)

See appendix pages vi-viii for surface material options.

- Choose Veneer Finish, if applicable
- Choose Metal Finish, if applicable
- Choose Paint Finish, if applicable



DESK: MODESTY PANEL

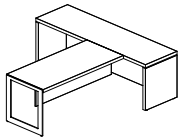

HOOP
(1/2 HEIGHT)

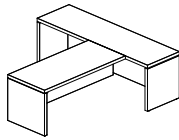

FACETED PANEL
(1/2 HEIGHT)

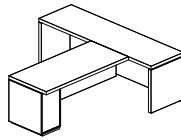

PEDESTAL - 15.5"
(1/2 HEIGHT)

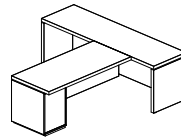

PED - 18"
(1/2 HEIGHT)

SURFACE MATERIAL KEY

S All Paint
V Veneer

RUN-OFF DESK: STANDARD HEIGHT

MODEL #	DEPTH	WIDTH	SEAT CLEARANCE WIDTH	DESCRIPTION	-S	-V
HOOP // 1/2 HEIGHT MODESTY // SET BACK 8 // INSET 2" EACH SIDE						
MP-RH-60	12	56	60	60" Run-Off Desk Modesty	1,404	1,525
MP-RH-66	12	62	66	66" Run-Off Desk Modesty	1,554	1,690
MP-RH-72	12	68	72	72" Run-Off Desk Modesty	1,705	1,851
MP-RH-78	12	74	78	78" Run-Off Desk Modesty	1,854	2,014
MP-RH-84	12	80	84	84" Run-Off Desk Modesty	2,004	2,176
FACETED PANEL // 1/2 HEIGHT MODESTY // SET BACK 8 // INSET 2" EACH SIDE						
MP-RF-60	12	50.3125	54.3	60" Run-Off Desk Modesty	1,404	1,525
MP-RF-66	12	56.3125	60.3	66" Run-Off Desk Modesty	1,554	1,690
MP-RF-72	12	62.3125	66.3	72" Run-Off Desk Modesty	1,705	1,851
MP-RF-78	12	68.3125	72.3	78" Run-Off Desk Modesty	1,854	2,014
MP-RF-84	12	74.3125	78.3	84" Run-Off Desk Modesty	2,004	2,176
PED - 15.5" // 1/2 HEIGHT MODESTY // SET BACK 8 // INSET 2" EACH SIDE						
MP-RP15-60	12	40.5	44.5	60" Run-Off Desk Modesty	1,404	1,525
MP-RP15-66	12	46.5	50.5	66" Run-Off Desk Modesty	1,554	1,690
MP-RP15-72	12	52.5	56.5	72" Run-Off Desk Modesty	1,705	1,851
MP-RP15-78	12	58.5	62.5	78" Run-Off Desk Modesty	1,854	2,014
MP-RP15-84	12	64.5	68.5	84" Run-Off Desk Modesty	2,004	2,176
PED - 18" // 1/2 HEIGHT MODESTY // SET BACK 8 // INSET 2" EACH SIDE						
MP-RP18-60	12	38	42	60" Run-Off Desk Modesty	1,404	1,525
MP-RP18-66	12	44	48	66" Run-Off Desk Modesty	1,554	1,690
MP-RP18-72	12	50	54	72" Run-Off Desk Modesty	1,705	1,851
MP-RP18-78	12	56	60	78" Run-Off Desk Modesty	1,854	2,014
MP-RP18-84	12	62	66	84" Run-Off Desk Modesty	2,004	2,176

GENERAL INFORMATION

- Modesty panel required with Freestanding Metal Hoop Leg
- Modesty panel required with Freestanding Faceted Panel Base

REQUIRED INFORMATION (ORDER CANNOT BE ENTERED WITHOUT THIS INFORMATION)

See appendix pages vi-viii for surface material options.

- Choose Veneer Finish, if applicable
- Choose Metal Finish, if applicable
- Choose Paint Finish, if applicable



SINGLE PEDESTAL DESK: MODESTY PANELS

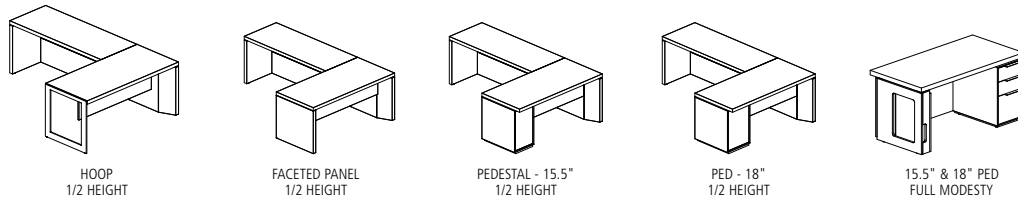

SURFACE MATERIAL KEY

S All Paint
V Veneer

SINGLE PEDESTAL DESK: STANDARD HEIGHT // FACETED CORNER SUPPORT

MODEL #	DEPTH	WIDTH	SEAT CLEARANCE WIDTH	DESCRIPTION	-S	-V
HOOP // 1/2 HEIGHT MODESTY // SET BACK 8 // INSET 2" EACH SIDE						
MP-FC-H-60	12	50.3125	34	60" Run-Off Desk Modesty	1,404	1,525
MP-FC-H-66	12	56.3125	40	66" Run-Off Desk Modesty	1,554	1,690
MP-FC-H-72	12	62.3125	46	72" Run-Off Desk Modesty	1,705	1,851
MP-FC-H-78	12	68.3125	52	78" Run-Off Desk Modesty	1,854	2,014
MP-FC-H-84	12	74.3125	58	84" Run-Off Desk Modesty	2,004	2,176
FACETED PANEL // 1/2 HEIGHT MODESTY // SET BACK 8 // INSET 2" EACH SIDE						
MP-FC-F-60	12	44.625	28.3	60" Run-Off Desk Modesty	1,404	1,525
MP-FC-F-66	12	50.625	34.3	66" Run-Off Desk Modesty	1,554	1,690
MP-FC-F-72	12	56.625	40.3	72" Run-Off Desk Modesty	1,705	1,851
MP-FC-F-78	12	62.625	46.3	78" Run-Off Desk Modesty	1,854	2,014
MP-FC-F-84	12	68.625	52.3	84" Run-Off Desk Modesty	2,004	2,176
PED - 15.5" // 1/2 HEIGHT MODESTY // SET BACK 8 // INSET 2" EACH SIDE						
MP-FC-P15-60	12	34.8125	18.5	60" Run-Off Desk Modesty	1,404	1,525
MP-FC-P15-66	12	40.8125	24.5	66" Run-Off Desk Modesty	1,554	1,690
MP-FC-P15-72	12	46.8125	30.5	72" Run-Off Desk Modesty	1,705	1,851
MP-FC-P15-78	12	52.8125	36.5	78" Run-Off Desk Modesty	1,854	2,014
MP-FC-P15-84	12	58.8125	42.5	84" Run-Off Desk Modesty	2,004	2,176
PED - 18" // 1/2 HEIGHT MODESTY // SET BACK 8 // INSET 2" EACH SIDE						
MP-FC-P18-60	12	32.3125	16	60" Run-Off Desk Modesty	1,404	1,525
MP-FC-P18-66	12	38.3125	22	66" Run-Off Desk Modesty	1,554	1,690
MP-FC-P18-72	12	44.3125	28	72" Run-Off Desk Modesty	1,705	1,851
MP-FC-P18-78	12	50.3125	34	78" Run-Off Desk Modesty	1,854	2,014
MP-FC-P18-84	12	56.3125	40	84" Run-Off Desk Modesty	2,004	2,176

SINGLE PED DESK: STANDARD HEIGHT // PANEL CORNER SUPPORT

MODEL #	DEPTH	WIDTH	DESCRIPTION	-S	-V
15.5" & 18" PED // FULL MODESTY (USE SAME FROM FREESTANDING DESK)					
MP-P-60	26	60	60" Freestanding Desk Modesty	1,548	1,820
MP-P-66	26	66	66" Freestanding Desk Modesty	1,736	2,043
MP-P-72	26	72	72" Freestanding Desk Modesty	1,928	2,270
MP-P-78	26	78	78" Freestanding Desk Modesty	2,119	2,493
MP-P-84	26	84	84" Freestanding Desk Modesty	2,311	2,716

REQUIRED INFORMATION (ORDER CANNOT BE ENTERED WITHOUT THIS INFORMATION)

See appendix pages vi-viii for surface material options.

- Choose Veneer Finish, if applicable
- Choose Metal Finish, if applicable
- Choose Paint Finish, if applicable



SINGLE PEDESTAL DESK: MODESTY PANELS

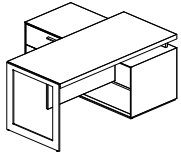

HOOP
1/2 HEIGHT

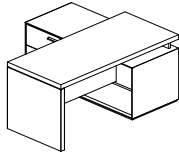

FACETED PANEL
1/2 HEIGHT

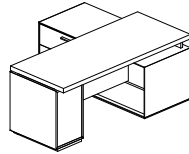

PEDESTAL - 15.5"
1/2 HEIGHT

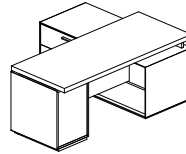

PED - 18"
1/2 HEIGHT

SURFACE MATERIAL KEY

S All Paint
V Veneer

SINGLE PEDESTAL DESK: STANDARD HEIGHT // BOOKCASE CORNER SUPPORT // COMMON CASE

MODEL #	DEPTH	WIDTH	SEAT CLEARANCE WIDTH	DESCRIPTION	-S	-V
HOOP // 1/2 HEIGHT MODESTY // SET BACK 8 // INSET 2" EACH SIDE						
MP-BC-H-60	12	30	34	60" Run-Off Desk Modesty	1,404	1,525
MP-BC-H-66	12	36	40	66" Run-Off Desk Modesty	1,554	1,690
MP-BC-H-72	12	42	46	72" Run-Off Desk Modesty	1,705	1,851
MP-BC-H-78	12	48	52	78" Run-Off Desk Modesty	1,854	2,014
MP-BC-H-84	12	54	58	84" Run-Off Desk Modesty	2,004	2,176
FACETED PANEL // 1/2 HEIGHT MODESTY // SET BACK 8 // INSET 2" EACH SIDE						
MP-BC-F-60	12	24.3125	28.3	60" Run-Off Desk Modesty	1,404	1,525
MP-BC-F-66	12	30.3125	34.3	66" Run-Off Desk Modesty	1,554	1,690
MP-BC-F-72	12	36.3125	40.3	72" Run-Off Desk Modesty	1,705	1,851
MP-BC-F-78	12	42.3125	46.3	78" Run-Off Desk Modesty	1,854	2,014
MP-BC-F-84	12	48.3125	52.3	84" Run-Off Desk Modesty	2,004	2,176
PED - 15.5" // 1/2 HEIGHT MODESTY // SET BACK 8 // INSET 2" EACH SIDE						
MP-BC-P15-60	12	14.5	18.5	60" Run-Off Desk Modesty	1,404	1,525
MP-BC-P15-66	12	20.5	24.5	66" Run-Off Desk Modesty	1,554	1,690
MP-BC-P15-72	12	26.5	30.5	72" Run-Off Desk Modesty	1,705	1,851
MP-BC-P15-78	12	32.5	36.5	78" Run-Off Desk Modesty	1,854	2,014
MP-BC-P15-84	12	38.5	42.5	84" Run-Off Desk Modesty	2,004	2,176
PED - 18" // 1/2 HEIGHT MODESTY // SET BACK 8 // INSET 2" EACH SIDE						
MP-BC-P18-60	12	12	16	60" Run-Off Desk Modesty	1,404	1,525
MP-BC-P18-66	12	18	22	66" Run-Off Desk Modesty	1,554	1,690
MP-BC-P18-72	12	24	28	72" Run-Off Desk Modesty	1,705	1,851
MP-BC-P18-78	12	30	34	78" Run-Off Desk Modesty	1,854	2,014
MP-BC-P18-84	12	36	40	84" Run-Off Desk Modesty	2,004	2,176

REQUIRED INFORMATION (ORDER CANNOT BE ENTERED WITHOUT THIS INFORMATION)

See appendix pages vi-viii for surface material options.

- Choose Veneer Finish, if applicable
- Choose Metal Finish, if applicable
- Choose Paint Finish, if applicable



ACCESS PANELS: STATIC



HOOP
1/2 HEIGHT

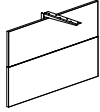

FACETED PANEL
1/2 HEIGHT

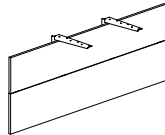

PEDESTAL - 15.5"
1/2 HEIGHT

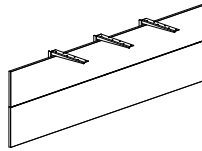

PED - 18"
1/2 HEIGHT

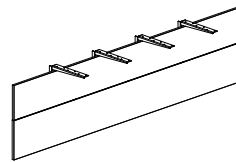

15.5" & 18" PED
FULL MODESTY

SURFACE MATERIAL KEY

S All Paint
V Veneer

ACCESS PANEL (FINAL PART NUMBER SHOULD BE THE ACTUAL LENGTH OF ACCESS PANEL NEEDED. EXAMPLE:g-30)

MODEL #	MINIMUM WIDTH	MAXIMUM WIDTH	DESCRIPTION	-S	-V
AAAP-S-XX	12	40	Access Panel (No Work Surface Support)	1,398	1,474
AAAP-S-XX	41	69	Access Panel (One Work Surface Support)	1,494	1,583
AAAP-S-XX	70	87	Access Panel (Two Work Surface Supports)	1,653	1,737
AAAP-S-XX	88	105	Access Panel (Three Work Surface Supports)	1,816	1,914
AAAP-S-XX	106	116	Access Panel (Four Work Surface Supports)	2,000	2,106

GENERAL INFORMATION

- Final part number should be the actual length of Access Panel needed. Example: AAAP-S-30

REQUIRED INFORMATION (ORDER CANNOT BE ENTERED WITHOUT THIS INFORMATION)

See appendix pages vi-viii for surface material options.

- Choose Veneer Finish, if applicable
- Choose Metal Finish, if applicable
- Choose Paint Finish, if applicable



ACCESS PANELS: ADJUSTABLE HEIGHT

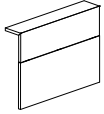

HOOP
1/2 HEIGHT

SURFACE MATERIAL KEY

S All Paint
V Veneer

ACCESS PANEL (FINAL PART NUMBER SHOULD BE THE ACTUAL LENGTH OF ACCESS PANEL NEEDED. EXAMPLE: AAAP-AH-30)

MODEL #	MINIMUM WIDTH	MAXIMUM WIDTH	DESCRIPTION	-S	-V
AAAP-AH-XX	12	30	Access Panel for openings 12"-30"	1,455	1,532
AAAP-AH-XX	31	60	Access Panel for openings 31"-60"	1,618	1,705
AAAP-AH-XX	61	90	Access Panel for openings 61"-90"	1,779	1,874

GENERAL INFORMATION

- Final part number should be the actual length of Access Panel needed. Example: AAAP-AH-30

REQUIRED INFORMATION (ORDER CANNOT BE ENTERED WITHOUT THIS INFORMATION)

See appendix pages vi-viii for surface material options.

- Choose Veneer Finish, if applicable
- Choose Metal Finish, if applicable
- Choose Paint Finish, if applicable



26" -DEEP CREDENZA / BRIDGE WORK SURFACES

FOR USE WHEN NOT ADJACENT TO A WORK WALL OR WHEN EXPOSED

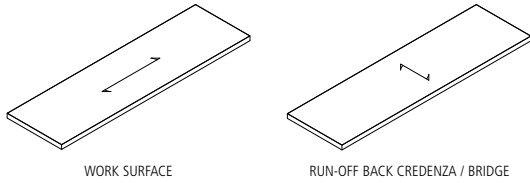

SURFACE MATERIAL KEY

V Veneer

**26"-DEEP WORK SURFACE
SIDE CREDENZA // RETURN // FREESTANDING (FREESTANDING, L-SHAPE, T-SHAPE, U-SHAPE)
RUN-OFF BACK CREDENZA (U-SHAPE WITH LOW SIDE CREDENZA)**

MODEL #	MINIMUM WIDTH	MAXIMUM WIDTH	DESCRIPTION	-V
AAC-2630	26	30	Credenza Work Surface	1,606
AAC-2636	26	36	Credenza Work Surface	2,016
AAC-2642	26	42	Credenza Work Surface	2,159
AAC-2648	26	48	Credenza Work Surface	2,328
AAC-2654	26	54	Credenza Work Surface	2,463
AAC-2660	26	60	Credenza Work Surface	3,776
AAC-2666	26	66	Credenza Work Surface	4,032
AAC-2672	26	72	Credenza Work Surface	4,290
AAC-2678	26	78	Credenza Work Surface	4,540
AAC-2684	26	84	Credenza Work Surface	4,787
AAC-2690	26	90	Credenza Work Surface	5,029
AAC-2696	26	96	Credenza Work Surface	5,274
AAC-26102	26	102	Credenza Work Surface	5,503
AAC-26108	26	108	Credenza Work Surface	5,282
AAC-26114	26	114	Credenza Work Surface	5,537
AAC-26120	26	120	Credenza Work Surface	5,781

If using a Height Adjustable support against a work wall **-XL or -XR** No Charge "L" and "R" designates Left or Right relative to the user

**26"-DEEP RUN-OFF BACK CREDENZA / BRIDGE
(U-SHAPE APPLICATIONS)**

MODEL #	MINIMUM WIDTH	MAXIMUM WIDTH	DESCRIPTION	-V
AAR-2630	26	30	Credenza Work Surface	1,713
AAR-2636	26	36	Credenza Work Surface	2,008
AAR-2642	26	42	Credenza Work Surface	2,159
AAR-2648	26	48	Credenza Work Surface	2,328
AAR-2654	26	54	Credenza Work Surface	2,463
AAR-2660	26	60	Credenza Work Surface	2,895
AAR-2666	26	66	Credenza Work Surface	3,153
AAR-2672	26	72	Credenza Work Surface	3,405
AAR-2678	26	78	Credenza Work Surface	3,654
AAR-2684	26	84	Credenza Work Surface	3,895
AAR-2690	26	90	Credenza Work Surface	4,138
AAR-2696	26	96	Credenza Work Surface	4,371
AAR-26102	26	102	Credenza Work Surface	4,602
AAR-26108	26	108	Credenza Work Surface	4,832
AAR-26114	26	114	Credenza Work Surface	5,064
AAR-26120	26	120	Credenza Work Surface	5,277

If using a Height Adjustable support against a work wall **-XL or -XR** No Charge "L" and "R" designates Left or Right relative to the user

If using with a Height Adjustable Support:
 Adjacent to (1) Tower **-T**
 Between (2) Towers **-TT**
 Between (1) Tower and (1) Storage Shelf **-TS**
 Adjacent to (1) Storage Shelf **-S**
 Between (2) Storage Shelves **-SS**



26" -DEEP CREDENZA / BRIDGE WORK SURFACES

OPTIONS	CODE	PRICE	NOTES
2"-Diameter Grommet Options:			
Center Grommet	-WPRC	\$234	
Left Grommet	-WPRL	\$234	
Right Grommet	-WPRR	\$234	
Left and Right Grommet	-WPR2	\$465	
Polished Chrome Grommet	-PCG	\$98	per Grommet
Power Spec / USB Spec Options:			
Center Unit	-SP-C		Please Note: Power Spec and USB Spec are specified separately. See page 83.
Left Unit	-SP-L		
Right Unit	-SP-R		
Left and Right Units	-SP-LR		

GENERAL INFORMATION

- Veneer species often dictates cut, default veneer cut is flat
- Work surface is 2"-thick with square edge profile
- Grain direction on work surfaces should always run parallel to a seam
- Work surface tops will be grain-matched sets based on configuration
- Grommets available in Powder Coat, Clear Anodized, and Polished Chrome (upcharge applies)
- Power Spec and USB Spec specified separately. See page 83.
- See page 84 for Pencil Stop information

REQUIRED INFORMATION (ORDER CANNOT BE ENTERED WITHOUT THIS INFORMATION)

See appendix pages vi-viii for surface material options.

- Choose Veneer Finish, if applicable
- Choose Metal Finish, if applicable
- Choose Paint Finish, if applicable



24" -DEEP CREDENZA / BRIDGE WORK SURFACES

FOR USE WHEN ADJACENT TO A WORK WALL

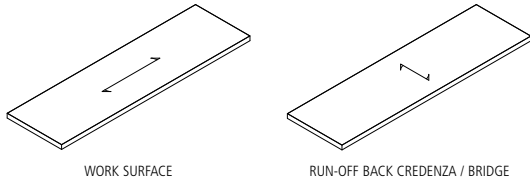

SURFACE MATERIAL KEY

V Veneer

**24"-DEEP WORK SURFACE
SIDE CREDENZA // RETURN (L-SHAPE, T-SHAPE, U-SHAPE)
RUN-OFF BACK CREDENZA (U-SHAPE WITH LOW SIDE CREDENZA)**

MODEL #	MINIMUM WIDTH	MAXIMUM WIDTH	DESCRIPTION	-V
AAC-2430	24	30	Credenza Work Surface	1,606
AAC-2436	24	36	Credenza Work Surface	1,900
AAC-2442	24	42	Credenza Work Surface	2,801
AAC-2448	24	48	Credenza Work Surface	3,061
AAC-2454	24	54	Credenza Work Surface	3,313
AAC-2460	24	60	Credenza Work Surface	3,560
AAC-2466	24	66	Credenza Work Surface	3,804
AAC-2472	24	72	Credenza Work Surface	4,047
AAC-2478	24	78	Credenza Work Surface	4,283
AAC-2484	24	84	Credenza Work Surface	4,514
AAC-2490	24	90	Credenza Work Surface	4,745
AAC-2496	24	96	Credenza Work Surface	4,975
AAC-24102	24	102	Credenza Work Surface	5,192
AAC-24108	24	108	Credenza Work Surface	4,981
AAC-24114	24	114	Credenza Work Surface	5,223
AAC-24120	24	120	Credenza Work Surface	5,451

If using a Height Adjustable support against a work wall **-XL or -XR** No Charge "L" and "R" designates Left or Right relative to the user

**24"-DEEP RUN-OFF BACK CREDENZA / BRIDGE
(U-SHAPE APPLICATIONS)**

MODEL #	MINIMUM WIDTH	MAXIMUM WIDTH	DESCRIPTION	-V
AAR-2430	24	30	Credenza Work Surface	1,606
AAR-2436	24	36	Credenza Work Surface	1,900
AAR-2442	24	42	Credenza Work Surface	2,801
AAR-2448	24	48	Credenza Work Surface	3,061
AAR-2454	24	54	Credenza Work Surface	3,313
AAR-2460	24	60	Credenza Work Surface	3,560
AAR-2466	24	66	Credenza Work Surface	3,804
AAR-2472	24	72	Credenza Work Surface	4,047
AAR-2478	24	78	Credenza Work Surface	4,283
AAR-2484	24	84	Credenza Work Surface	4,514
AAR-2490	24	90	Credenza Work Surface	4,745
AAR-2496	24	96	Credenza Work Surface	4,975
AAR-24102	24	102	Credenza Work Surface	5,192
AAR-24108	24	108	Credenza Work Surface	4,981
AAR-24114	24	114	Credenza Work Surface	5,223
AAR-24120	24	120	Credenza Work Surface	5,451

If using a Height Adjustable support against a work wall **-XL or -XR** No Charge "L" and "R" designates Left or Right relative to the user

If using with a Height Adjustable Support:
 Adjacent to (1) Tower **-T**
 Between (2) Towers **-TT**
 Between (1) Tower and (1) Storage Shelf **-TS**
 Adjacent to (1) Storage Shelf **-S**
 Between (2) Storage Shelves **-SS**



24" -DEEP CREDENZA / BRIDGE WORK SURFACES

OPTIONS	CODE	PRICE	NOTES
2"-Diameter Grommet Options:			
Center Grommet	-WPRC	\$234	
Left Grommet	-WPRL	\$234	
Right Grommet	-WPRR	\$234	
Left and Right Grommet	-WPR2	\$465	
Polished Chrome Grommet	-PCG	\$98	per Grommet
Power Spec / USB Spec Options:			
Center Unit	-SP-C		Please Note: Power Spec and USB Spec are specified separately. See page 83.
Left Unit	-SP-L		
Right Unit	-SP-R		
Left and Right Units	-SP-LR		

GENERAL INFORMATION

- Veneer species often dictates cut, default veneer cut is flat
- Work surface is 2"-thick with square edge profile
- Grain direction on work surfaces should always run parallel to a seam
- Work surface tops will be grain-matched sets based on configuration
- Grommets available in Powder Coat, Clear Anodized, and Polished Chrome (upcharge applies)
- Power Spec and USB Spec specified separately. See page 83.
- See page 84 for Pencil Stop information

REQUIRED INFORMATION (ORDER CANNOT BE ENTERED WITHOUT THIS INFORMATION)

See appendix pages vi-viii for surface material options.

- Choose Veneer Finish, if applicable
- Choose Metal Finish, if applicable
- Choose Paint Finish, if applicable



CREDENZA SUPPORTS: STATIC

SURFACE MATERIAL KEY

- S All Paint
- V Veneer
- VS Veneer Case and Painted Front

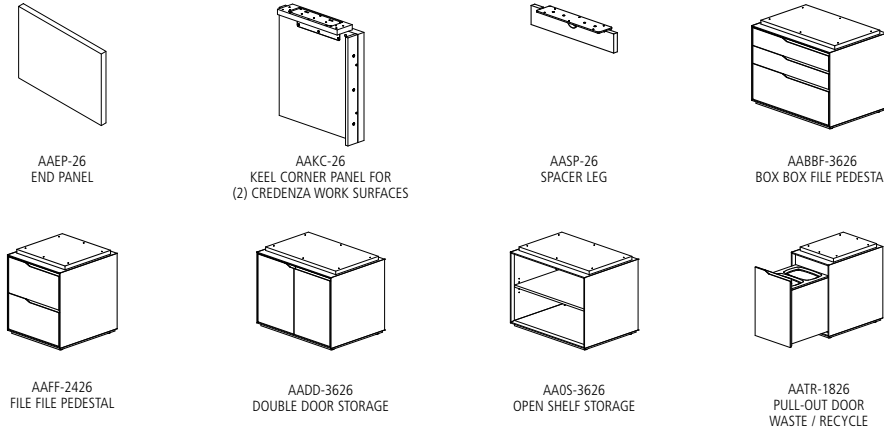

STATIC SUPPORTS

MODEL #	DEPTH	WIDTH	DESCRIPTION	-S	-V	-VS
AAEP-26	26	2	End Panel	1,050	1,106	-
AAKC-26-[]	26	2	Keel Corner Panel for Two Credenza Work Surfaces	1,487	1,565	-
AASP-24	24		Spacer Leg (Low Credenza Applications)	188	196	-
AASP-26	26		Spacer Leg (Low Credenza Applications)	188	196	-
AABBF-1826	26	18	Box Box File Pedestal	4,650	4,897	4,897
AABBF-2426	26	24	Box Box File Pedestal	5,115	5,385	5,385
AABBF-3026	26	30	Box Box File Pedestal	5,579	5,874	5,874
AABBF-3626	26	36	Box Box File Pedestal	6,046	6,364	6,364
AAFF-1826	26	18	File File Pedestal	4,349	4,575	4,575
AAFF-2426	26	24	File File Pedestal	4,785	5,035	5,035
AAFF-3026	26	30	File File Pedestal	5,218	5,492	5,492
AAFF-3626	26	36	File File Pedestal	5,653	5,948	5,948
AAD-1826-[]	26	18	Single Door Storage	3,880	4,084	4,084
AAD-2426-[]	26	24	Single Door Storage	4,058	4,272	4,272
AADD-3026	26	30	Double Door Storage	4,289	4,516	4,516
AADD-3626	26	36	Double Door Storage	4,468	4,701	4,701
AAOS-1826	26	18	Open Shelf Storage	3,445	3,627	-
AAOS-2426	26	24	Open Shelf Storage	3,541	3,724	-
AAOS-3026	26	30	Open Shelf Storage	3,625	3,816	-
AAOS-3626	26	36	Open Shelf Storage	3,715	3,910	-
AATR-1826	26	18	Pull-Out Door Waste/Recycle	4,349	4,575	4,575
AATR-2426	26	24	Pull-Out Door Waste/Recycle	4,785	5,035	5,035

[] Specify Left (-L) or Right (-R) relative to the user position

- FS Freestanding/No Adjacent Supp
- LH Left Hand Starter; Adjacent to -AO or -RH
- RH Right Hand Starter; Adjacent to -AO or -LH
- AO Add-on; Adjacent to -RH or -LH



CREDENZA SUPPORTS: STATIC

OPTIONS	CODE	PRICE	NOTES
Polished Chrome Hoop Leg:	-PC	\$1,779	per Hoop Leg
No Locks (Pedestals):	-NL	No Charge	
Pull Options:			
Integrated Pull (Metal Accent)	-MIP	No Charge	
Integrated Pull (Wood Accent)	-WIP	No Charge	
Metal Tab Pull	-MP	No Charge	
Polished Chrome Pulls	-PCP	\$309	per Pull

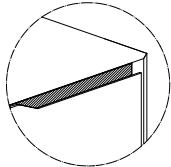

-MIP or -WIP

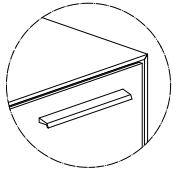

-MP

GENERAL INFORMATION

- Vertical grain direction
- Veneer species often dictates cut, default veneer cut is flat
- Case Height 28"
- Mitered case construction
- Face locking standard on all storage components
- Storage fronts will be grain-matched set
- All lateral, pedestal and box file drawers are standard with white drawer boxes and undermount soft closing slides
- Door and open shelf storage pedestals include a single adjustable height shelf
- Integrated pull includes a horizontal accent in which a finish must be specified; finish options include veneer, powdercoat, chrome accent, or clear anodized
- If a wood integrated pull (WIP) is selected on a veneer case with painted drawer fronts (VS), the finish of the wood on the integrated pull will default to the veneer of the case unless otherwise specified
- If a wood integrated pull (WIP) is selected on a painted case (S), the finish of the wood on the integrated pull will default to the paint color of the drawer unless otherwise specified
- Metal Tab Pull finish options include powdercoat, chrome, or clear anodized
- Box drawers include fabric wrapped drawer bottoms. Felt (K1207) or Hopsack (K1206) selection required. If no selection is made, the default choice will be Knoll Felt - Pewter.
- The back of the integrated pull will reflect the wood or metal selection (see shaded area of drawing)
- Spacer leg matches case finish
- Single door storage units are handed and are defined by the hinge side

REQUIRED INFORMATION (ORDER CANNOT BE ENTERED WITHOUT THIS INFORMATION)

See appendix pages vi-viii for surface material options.

- Choose Veneer Finish, if applicable
- Choose Metal Finish, if applicable
- Choose Paint Finish, if applicable
- Choose Pull option for Pedestals: Integrated Pull (-MIP or -WIP) or Metal Pull (-MP)
- Choose Fabric option, if applicable



CREDENZA SUPPORTS: LOW, STATIC

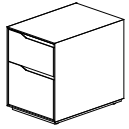

AAL-BF-1826
1/2 HEIGHT

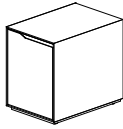

AAL-D-1826
1/2 HEIGHT

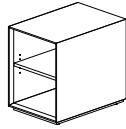

AAL-OS-1826
1/2 HEIGHT

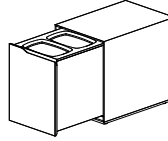

AAL-TR-1826
1/2 HEIGHT

SURFACE MATERIAL KEY

- S All Paint
- V Veneer
- V Veneer Cased and Painted Front

LOW STORAGE // 23.5"-HIGH

MODEL #	DEPTH	WIDTH	HEIGHT	DESCRIPTION	-S	-V	-VS
AAL-BF-1826	26	18	23.5	Box File Pedestal	3,953	4,163	4,163
AAL-BF-2426	26	24	23.5	Box File Pedestal	4,350	4,576	4,576
AAL-BF-3026	26	30	23.5	Box File Pedestal	4,745	4,993	4,993
AAL-BF-3626	26	36	23.5	Box File Pedestal	5,138	5,409	5,409
AAL-D-1826-[]	26	18	23.5	18"W x 26"D Single Door Storage	3,859	4,060	4,060
AAL-D-2426-[]	26	24	23.5	24"W x 26"D Single Door Storage	3,947	4,153	4,153
AAL-DD-3026	26	30	23.5	30"W x 26"D Double Door Storage	4,034	4,245	4,245
AAL-DD-3626	26	36	23.5	36"W x 26"D Double Door Storage	4,441	4,675	4,675
AAL-OS-1826	26	18	23.5	18"W x 26"D Open Shelf Storage	3,428	3,606	3,606
AAL-OS-2426	26	24	23.5	24"W x 26"D Open Shelf Storage	3,514	3,699	3,699
AAL-OS-3026	26	30	23.5	30"W x 26"D Open Shelf Storage	3,602	3,793	3,793
AAL-OS-3626	26	36	23.5	36"W x 26"D Open Shelf Storage	3,694	3,888	3,888
AAL-TR-1826	26	18	23.5	18"W x 26"D Pull-Out Door Waste/Recycle	3,914	4,120	4,120
AAL-TR-2426	26	24	23.5	24"W x 26"D Pull-Out Door Waste/Recycle	4,306	4,532	4,532

[] Specify Left (-L) or Right (-R) relative to the user

OPTIONS

	CODE	PRICE	NOTES
Polished Chrome Hoop Leg:	-PC	\$1,779	per Hoop Leg
No Locks (Pedestals):	-NL	No Charge	
Pull Options:			
Integrated Pull (Metal Accent)	-MIP	No Charge	
Integrated Pull (Wood Accent)	-WIP	No Charge	
Metal Tab Pull	-MP	No Charge	
Polished Chrome Pulls	-PCP	\$309	per Pull
24" or 30"-wide Seat Cushion (1 yd):			
COM Fabric	-SC-1COM	\$455	
Grade A	-SC-1A	\$711	
Grade B	-SC-1B	\$799	
Grade C	-SC-1C	\$908	
Grade D	-SC-1D	\$1,009	
Grade E	-SC-1E	\$1,118	
Grade F	-SC-1F	\$1,191	
Grade G	-SC-1G	\$1,299	
Grade H	-SC-1H	\$1,345	
36"-wide Seat Cushion (1-1/2 yd):			
COM Fabric	-SC-COM	\$681	
Grade A	-SC-A	\$1,063	
Grade B	-SC-B	\$1,196	
Grade C	-SC-C	\$1,361	
Grade D	-SC-D	\$1,520	
Grade E	-SC-E	\$1,677	
Grade F	-SC-F	\$1,786	
Grade G	-SC-G	\$1,943	
Grade H	-SC-H	\$2,016	

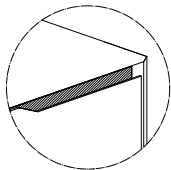

-MIP or -WIP

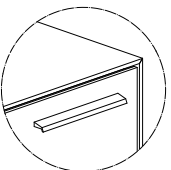

-MP

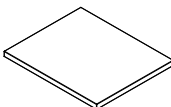

Seat Cushion



CREDENZA SUPPORTS: LOW, STATIC

GENERAL INFORMATION

- Vertical grain direction
- Veneer species often dictates cut, default veneer cut is flat
- Case Height 28"
- Mitered case construction
- Face locking standard on all storage components
- Storage fronts will be grain-matched set
- All lateral, pedestal and box file drawers are standard with white drawer boxes and undermount soft closing slides
- Door and open shelf storage pedestals include a single adjustable height shelf
- Integrated pull includes a horizontal accent in which a finish must be specified; finish options include veneer, powdercoat, chrome accent, or clear anodized
- If a wood integrated pull (WIP) is selected on a veneer case with painted drawer fronts (VS), the finish of the wood on the integrated pull will default to the veneer of the case unless otherwise specified
- If a wood integrated pull (WIP) is selected on a painted case (S), the finish of the wood on the integrated pull will default to the paint color of the drawer unless otherwise specified
- Metal Tab Pull finish options include powdercoat, chrome, or clear anodized
- Box drawers include fabric wrapped drawer bottoms. Felt (K1207) or Hopsack (K1206) selection required. If no selection is made, the default choice will be Knoll Felt - Pewter.
- The back of the integrated pull will reflect the wood or metal selection (see shaded area of drawing)
- Single door storage units are handed and are defined by the hinge side.

REQUIRED INFORMATION (ORDER CANNOT BE ENTERED WITHOUT THIS INFORMATION)

See appendix pages vi-viii for surface material options.

- Choose Veneer Finish, if applicable
- Choose Metal Finish, if applicable
- Choose Paint Finish, if applicable
- Choose Pull option for Pedestals: Integrated Pull (-MIP or -WIP) or Metal Pull (-MP)
- Choose Fabric option, if applicable



CREDENZA SUPPORTS: ADJUSTABLE HEIGHT

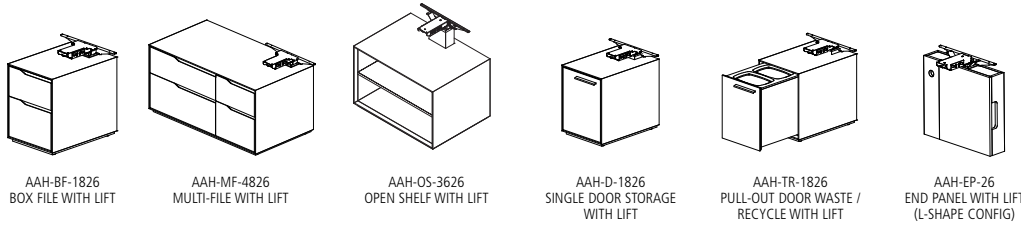

SURFACE MATERIAL KEY

S All Paint
 V Veneer
 VS Veneer Case and Painted Front

ADJUSTABLE HEIGHT CREDENZA / RETURN SUPPORT // 23.5"-HIGH

MODEL #	DEPTH	WIDTH	DESCRIPTION	-S	-V	-VS
AAH-BF-1826	26	18	Box File with Lift Support	6,277	6,536	6,536
AAH-BF-2426	26	24	Box File with Lift Support	6,513	6,783	6,783
AAH-BF-3026	26	30	Box File with Lift Support	6,977	7,271	7,271
AAH-BF-3626	26	36	Box File with Lift Support	7,442	7,759	7,759
AAH-MF-4826-[]	26	48	Multi File with Lift Support (18" & 30" Box File)	8,094	8,432	8,432
AAH-OS-1826	26	18	Open Shelf with Lift Support	4,844	5,025	-
AAH-OS-2426	26	24	Open Shelf with Lift Support	4,936	5,121	-
AAH-OS-3026	26	30	Open Shelf with Lift Support	5,022	5,211	-
AAH-OS-3626	26	36	Open Shelf with Lift Support	5,113	5,308	-
AAH-D-1826-[]	26	18	Single Door Storage with Lift Support	5,276	5,484	5,484
AAH-D-2426-[]	26	24	Single Door Storage with Lift Support	5,457	5,667	5,667
AAH-DD-3026	26	30	Double Door Storage with Lift Support	5,687	5,912	5,912
AAH-DD-3626	26	36	Double Storage with Lift Support	5,863	6,100	6,100
AAH-TR-1826	26	18	Pull-Out Door Waste/Recycle with Lift Support	5,745	5,975	5,975
AAH-TR-2426	26	24	Pull-Out Door Waste/Recycle with Lift Support	6,181	6,429	6,429
AAH-EP-26-[]	26	5	End Panel with Lift Support for L-Shape Configuration	2,451	2,504	-

[] Specify Left (-L) or Right (-R) relative to the user position

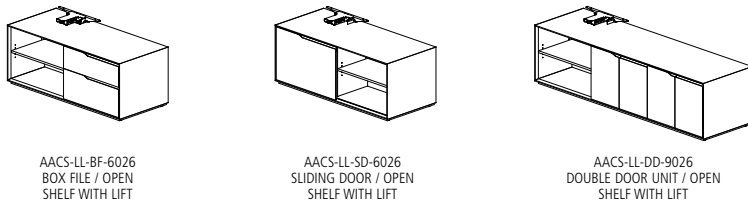

SURFACE MATERIAL KEY

S All Paint
 V Veneer
 VS Veneer Case and Painted Front

LOW COMMON CASE WITH LIFT // L-SHAPE APPLICATIONS // 23.5"-HIGH

MODEL #	DEPTH	WIDTH	DESCRIPTION	-S	-V	-VS
AACS-LL-BF-6026-[]	26	60	(1) 30"W Box File with 30"W Open Shelf with Lift	8,952	9,283	9,283
AACS-LL-BF-7226-[]	26	72	(1) 36"W Box File with 36"W Open Shelf with Lift	9,676	10,040	10,040
AACS-LL-BF-9026-[]	26	90	(2) 30"W Box File with 30"W Open Shelf with Lift	12,698	13,222	13,222
AACS-LL-BF-10826-[]	26	108	(2) 36"W Box File with 36"W Open Shelf with Lift	13,466	14,032	14,032
AACS-LL-SD-6026-[]	26	60	(1) 30"W Sliding Door with 30"W Open Shelf with Lift	8,952	9,283	9,283
AACS-LL-SD-7226-[]	26	72	(1) 36"W Sliding Door with 36"W Open Shelf with Lift	9,676	10,040	10,040
AACS-LL-SD-9026-[]	26	90	(1) 30"W Sliding Door with 30"W Open Shelf with Lift	12,698	13,222	13,222
AACS-LL-SD-10826-[]	26	108	(1) 36"W Sliding Door with 36"W Open Shelf with Lift	13,466	14,032	14,032
AACS-LL-DD-6026-[]	26	60	(1) 30"W Double Door Unit with 30"W Open Shelf with Lift	8,952	9,283	9,283
AACS-LL-DD-7226-[]	26	72	(1) 36"W Double Door Unit with 36"W Open Shelf with Lift	9,676	10,040	10,040
AACS-LL-DD-9026-[]	26	90	(2) 30"W Double Door Units with 30"W Open Shelf with Lift	12,698	13,222	13,222
AACS-LL-DD-10826-[]	26	108	(2) 36"W Double Door Units with 36"W Open Shelf with Lift	13,466	14,032	14,032

[] Specify Left (-L) or Right (-R) relative to the position of the lift



CREDENZA SUPPORTS: ADJUSTABLE HEIGHT

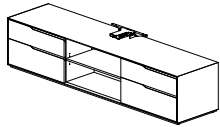

AACS-TL-BF-10826
BOX FILE / OPEN SHELF WITH LIFT

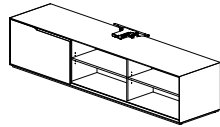

AACS-TL-SD-10826
SLIDING DOOR / OPEN SHELVES WITH LIFT

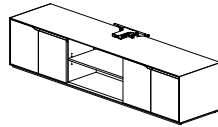

AACS-TL-DD-10826
DOUBLE DOOR UNITS / OPEN SHELF WITH LIFT

SURFACE MATERIAL KEY

- S All Paint
- V Veneer
- VS Veneer Case and Painted Front

T-SHAPE APPLICATIONS // 23.5"-HIGH

MODEL #	DEPTH	WIDTH	DESCRIPTION	-S	-V	-VS
AACS-TL-BF-9026	26	90	(2) 30"W Box File with 30"W Open Shelf with Lift	12,698	13,222	13,222
AACS-TL-BF-10826	26	108	(2) 36"W Box File with 36"W Open Shelf with Lift	13,466	14,032	14,032
AACS-TL-SD-9026	26	90	(1) 30"W Sliding Door with (2) 30"W Open Shelves with Lift	12,698	13,222	13,222
AACS-TL-SD-10826	26	108	(1) 36"W Sliding Door with (2) 36"W Open Shelves with Lift	13,466	14,032	14,032
AACS-TL-DD-9026	26	90	(2) 30"W Double Door Units with 30"W Open Shelf with Lift	12,698	13,222	13,222
AACS-TL-DD-10826	26	108	(2) 36"W Double Door Units with 36"W Open Shelf with Lift	13,466	14,032	14,032

[] Specify Left (-L) or Right (-R) relative to the position of the lift

LIFT SUPPORT (MUST BE SPECIFIED)

MODEL #	DESCRIPTION	PRICE
AALIFT-2	Add when there is one Height Adjustable Work Surface	No Charge
AALIFT-3	Add when there are two connected Height Adjustable work surfaces	No Charge

OPTIONS	CODE	PRICE	NOTES
No Locks (Pedestals):	-NL	No Charge	
Pull Options:			
Integrated Pull (Metal Accent)	-MIP	No Charge	
Integrated Pull (Wood Accent)	-WIP	No Charge	
Metal Tab Pull	-MP	No Charge	
Polished Chrome Pulls	-PCP	\$309	per Pull

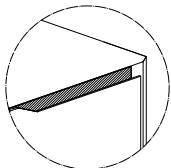

-MIP or -WIP

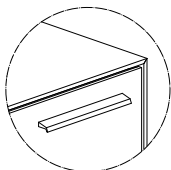

-MP



CREDENZA SUPPORTS: ADJUSTABLE HEIGHT

GENERAL INFORMATION

- Vertical grain direction
- Veneer species often dictates cut, default veneer cut is flat
- Case Height 23-1/2"
- Mitered case construction
- Credenza does not include the 2"-thick work surface nor does it accept a work surface as standard
- Run off desk is to be positioned above the open shelf located at either end of credenza
- Integrated pull includes a horizontal accent in which a finish must be specified; finish options include veneer, powdercoat, chrome accent, or clear anodized
- If a wood integrated pull (WIP) is selected on a veneer case with painted drawer fronts (VS), the finish of the wood on the integrated pull will default to the veneer of the case unless otherwise specified
- If a wood integrated pull (WIP) is selected on a painted case (S), the finish of the wood on the integrated pull will default to the paint color of the drawer unless otherwise specified
- Metal Tab Pull finish options include powdercoat, chrome, or clear anodized
- Face locking standard on all storage components
- Storage fronts will be grain-matched set
- All lateral, pedestal and box file drawers are standard with white drawer boxes and undermount soft closing slides
- Door and open shelf storage pedestals include a single adjustable height shelf
- Work surface height adjustable range of travel 28" - 46"
- Lift mechanisms are designed to support all desk components, plus a maximum of 100lbs additional weight
- Height adjustable lift mechanism is warranted for 2 years
- Box drawers include fabric wrapped drawer bottoms. Felt (K1207) or Hopsack (K1206) selection required. If no selection is made, the default choice will be Knoll Felt - Pewter.
- The back of the integrated pull will reflect the wood or metal selection (see shaded area of drawing)
- Sliding door common cases do not have locks
- Multi-file with lift support handedness is defined by the position of the 18" portion with the lift
- Single door storage units handedness is defined by the hinge side
- End panel with lift support handedness is based on the position under the work surface
- Handedness of low common cases with lifts is defined by the position of the lift, facing the unit

REQUIRED INFORMATION (ORDER CANNOT BE ENTERED WITHOUT THIS INFORMATION)

See appendix pages vi-viii for surface material options.

- Choose Veneer Finish, if applicable
- Choose Metal Finish, if applicable
- Choose Paint Finish, if applicable
- Choose Pull option for Pedestals: Integrated Pull (-MIP or -WIP) or Metal Pull (-MP)
- Choose Fabric option, if applicable



COMMON CASE CREDENZA SUPPORTS: STATIC

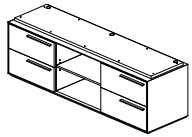

AACC-T-LF-9026
BOX FILE / OPEN SHELF

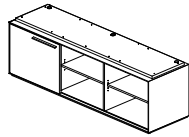

AACC-T-SD-9026
SLIDING DOOR / OPEN SHELVES

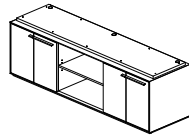

AACC-T-DD-9026
DOUBLE DOOR UNITS / OPEN SHELF

SURFACE MATERIAL KEY

- S All Paint
- V Veneer
- VS Veneer Case and Painted Front

COMMON CASE // T-SHAPE APPLICATIONS // 27"-HIGH

MODEL #	DEPTH	WIDTH	HEIGHT	DESCRIPTION	-S	-V	-VS
AACC-T-LF-9026	26	90	27	(2) 30"W Lateral File with 30"W Open Shelf	9,668	10,175	10,175
AACC-T-LF-10826	26	108	27	(2) 36"W Lateral File with 36"W Open Shelf	10,413	10,962	10,962
AACC-T-SD-9026	26	90	27	(2) 30"W Openings with 30"W Sliding Door	9,668	10,175	10,175
AACC-T-SD-10826	26	108	27	(2) 36"W Openings with 36"W Sliding Door	10,413	10,962	10,962
AACC-T-DD-9026	26	90	27	(2) 30"W Double Door Units with 30"W Open Shelf	9,668	10,175	10,175
AACC-T-DD-10826	26	108	27	(2) 36"W Double Door Units with 36"W Open Shelf	10,413	10,962	10,962

[] Specify Left (-L) or Right (-R) relative to the position of the open shelf from the center

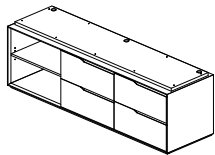

AACC-L-LF-9026
BOX FILE / OPEN SHELF

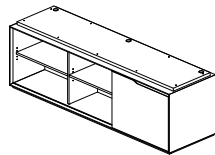

AACC-L-SD-9026
SLIDING DOOR / OPEN SHELVES

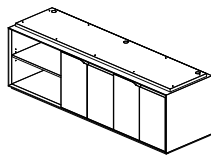

AACC-L-DD-9026
DOUBLE DOOR UNITS / OPEN SHELF

SURFACE MATERIAL KEY

- S All Paint
- V Veneer
- VS Veneer Case and Painted Front

COMMON CASE // L-SHAPE APPLICATIONS // 27"-HIGH

MODEL #	DEPTH	WIDTH	HEIGHT	DESCRIPTION	-S	-V	-VS
AACC-L-LF-6026-[]	26	60	27	(1) 30"W Lateral File with 30" W Open Shelf	6,503	6,846	6,846
AACC-L-LF-7226-[]	26	72	27	(1) 36"W Lateral File with 36"W Open Shelf	7,157	7,535	7,535
AACC-L-LF-9026-[]	26	90	27	(2) 30"W Lateral File with 30"W Open Shelf	10,270	10,810	10,810
AACC-L-LF-10826-[]	26	108	27	(2) 36"W Lateral File with 36"W Open Shelf	11,064	11,645	11,645
AACC-L-SD-6026-[]	26	60	27	(1) 30"W Open Shelves with 30"W Sliding Door	6,503	6,846	6,846
AACC-L-SD-7226-[]	26	72	27	(1) 36"W Open Shelves with 36"W Sliding Door	7,157	7,535	7,535
AACC-L-SD-9026-[]	26	90	27	(2) 30"W Open Shelves with 30"W Sliding Door	10,270	10,810	10,810
AACC-L-SD-10826-[]	26	108	27	(2) 36"W Open Shelves with 36"W Sliding Door	11,064	11,645	11,645
AACC-L-DD-6026-[]	26	60	27	(1) 30"W Double Door Unit with 30"W Open Shelf	6,503	6,846	6,846
AACC-L-DD-7226-[]	26	72	27	(1) 36"W Double Door Unit with 36"W Open Shelf	7,157	7,535	7,535
AACC-L-DD-9026-[]	26	90	27	(2) 30"W Double Door Units with 30"W Open Shelf	10,270	10,810	10,810
AACC-L-DD-10826-[]	26	108	27	(2) 36"W Double Door Units with 36"W Open Shelf	11,064	11,645	11,645

[] Specify Left (-L) or Right (-R) relative to the open shelf position



COMMON CASE CREDENZA SUPPORTS: STATIC

OPTIONS	CODE	PRICE	NOTES
Grommet	-GR	No Charge	
No Locks (Pedestals):	-NL	No Charge	
Pull Options:			
Integrated Pull (Metal Accent)	-MIP	No Charge	
Integrated Pull (Wood Accent)	-WIP	No Charge	
Metal Tab Pull	-MP	No Charge	
Polished Chrome Pulls	-PCP	\$309	per Pull

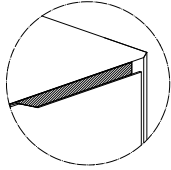

-MIP or -WIP

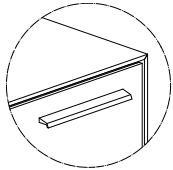

-MP

GENERAL INFORMATION

- Vertical grain direction
- Veneer species often dictates cut, default veneer cut is flat
- Case Height 28"
- Mitered case construction
- Credenza does not include the 2"-thick work surface. Must be specified for standard height common cases.
- Static run off desk is to be positioned above the open shelf
- Storage fronts will be grain-matched set
- All lateral, pedestal and box file drawers are standard with white drawer boxes and undermount soft closing slides
- Door and open shelf storage pedestals include a single adjustable height shelf
- Integrated pull includes a horizontal accent in which a finish must be specified; finish options include veneer, powdercoat, chrome accent, or clear anodized
- If a wood integrated pull (WIP) is selected on a veneer case with painted drawer fronts (VS), the finish of the wood on the integrated pull will default to the veneer of the case unless otherwise specified
- If a wood integrated pull (WIP) is selected on a painted case (S), the finish of the wood on the integrated pull will default to the paint color of the drawer unless otherwise specified
- Metal Tab Pull finish options include powdercoat, chrome, or clear anodized
- Box drawers include fabric wrapped drawer bottoms. Felt (K1207) or Hopsack (K1206) selection required. If no selection is made, the default choice will be Knoll Felt - Pewter.
- Face locking standard on all storage components
- The back of the integrated pull will reflect the wood or metal selection (see shaded area of drawing)
- Sliding door common cases do not have locks
- When adding a grommet to a standard height common case, ensure the work surface also has a grommet location option selected
- Handedness is based on the open shelf location, facing the unit

REQUIRED INFORMATION (ORDER CANNOT BE ENTERED WITHOUT THIS INFORMATION)

- See appendix pages vi-viii for surface material options.
- Choose Veneer Finish, if applicable
 - Choose Metal Finish, if applicable
 - Choose Paint Finish, if applicable
 - Choose Pull option for Pedestals: Integrated Pull (-MIP or -WIP) or Metal Pull (-MP)
 - Choose Fabric option, if applicable



COMMON CASE CREDENZA SUPPORTS: LOW, STATIC

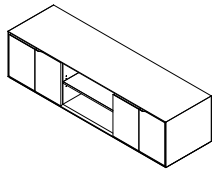

AACST-BF-9026
BOX FILE / OPEN SHELF

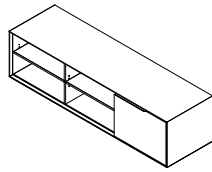

AACST-SD-9026
SLIDING DOOR / OPEN SHELVES

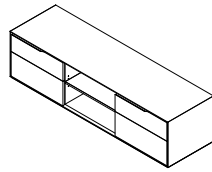

AACST-DD-9026
DOUBLE DOOR UNITS / OPEN SHELF

SURFACE MATERIAL KEY

- S All Paint
- V Veneer
- VS Veneer Case and Painted Front

LOW COMMON CASE // T-SHAPE APPLICATIONS // 23.5"-HIGH

MODEL #	DEPTH	WIDTH	HEIGHT	DESCRIPTION	-S	-V	-VS
AACST-BF-9026	26	90	23.5	(2) 30"W Box File with 30"W Open Shelf	9,386	9,878	9,878
AACST-BF-10826	26	108	23.5	(2) 36"W Box File with 36"W Open Shelf	10,109	10,643	10,643
AACST-SD-9026	26	90	23.5	(1) 30"W Sliding Door with (2) 30"W Open Shelf	9,386	9,878	9,878
AACST-SD-10826	26	108	23.5	(1) 36"W Sliding Door with (2) 36"W Open Shelves	10,109	10,643	10,643
AACST-DD-9026	26	90	23.5	(2) 30"W Double Door Units with 30"W Open Shelf	9,386	9,878	9,878
AACST-DD-10826	26	108	23.5	(2) 36"W Double Door Units with 36"W Open Shelf	10,109	10,643	10,643

[] Specify Left (-L) or Right (-R) relative to the position of the open shelf from the center

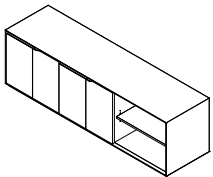

AACSL-BF-9026
BOX FILE / OPEN SHELF

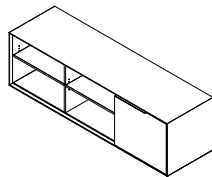

AACSL-SD-9026
SLIDING DOOR / OPEN SHELVES

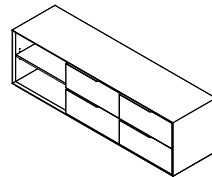

AACSL-DD-9026
DOUBLE DOOR UNITS / OPEN SHELF

SURFACE MATERIAL KEY

- S All Paint
- V Veneer
- VS Veneer Case and Painted Front

LOW COMMON CASE // L-SHAPE APPLICATIONS // 23.5"-HIGH

MODEL #	DEPTH	WIDTH	HEIGHT	DESCRIPTION	-S	-V	-VS
AACSL-BF-6026-[]	26	60	23.5	(1) 30"W Box File with 30"W Open Shelf	6,315	6,647	6,647
AACSL-BF-7226-[]	26	72	23.5	(1) 36"W Box File with 36"W Open Shelf	6,949	7,314	7,314
AACSL-BF-9026-[]	26	90	23.5	(2) 30"W Box File with 30"W Open Shelf	9,972	10,496	10,496
AACSL-BF-10826-[]	26	108	23.5	(2) 36"W Box File with 36"W Open Shelf	10,742	11,306	11,306
AACSL-SD-6026-[]	26	60	23.5	(1) 30"W Sliding Door with 30"W Open Shelf	6,315	6,647	6,647
AACSL-SD-7226-[]	26	72	23.5	(1) 36"W Sliding Door with 36"W Open Shelf	6,949	7,314	7,314
AACSL-SD-9026-[]	26	90	23.5	(1) 30"W Sliding Door with (2) 30"W Open Shelves	9,972	10,496	10,496
AACSL-SD-10826-[]	26	108	23.5	(1) 36"W Sliding Door with (2) 36"W Open Shelves	10,742	11,306	11,306
AACSL-DD-6026-[]	26	60	23.5	(1) 30"W Double Door Unit with 30"W Open Shelf	6,315	6,647	6,647
AACSL-DD-7226-[]	26	72	23.5	(1) 36"W Double Door Unit with 36"W Open Shelf	6,949	7,314	7,314
AACSL-DD-9026-[]	26	90	23.5	(2) 30"W Double Door Units with 30"W Open Shelf	9,972	10,496	10,496
AACSL-DD-10826-[]	26	108	23.5	(2) 36"W Double Door Units with 36"W Open Shelf	10,742	11,306	11,306

[] Specify Left (-L) or Right (-R) relative to the open shelf position



COMMON CASE CREDENZA SUPPORTS: LOW, STATIC

OPTIONS	CODE	PRICE	NOTES
Grommet	-GR	No Charge	
No Locks (Pedestals):	-NL	No Charge	
Pull Options:			
Integrated Pull (Metal Accent)	-MIP	No Charge	
Integrated Pull (Wood Accent)	-WIP	No Charge	
Metal Tab Pull	-MP	No Charge	
Polished Chrome Pulls	-PCP	\$309	per Pull

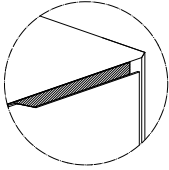

-MIP or -WIP

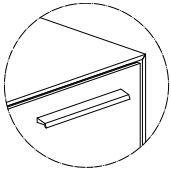

-MP

GENERAL INFORMATION

- Vertical grain direction
- Veneer species often dictates cut, default veneer cut is flat
- Case Height 23.5"
- Mitered case construction
- Credenza does not include the 2"-thick work surface. Must be specified for standard height common cases.
- Static run off desk is to be positioned above the open shelf
- Storage fronts will be grain-matched set
- All lateral, pedestal and box file drawers are standard with white drawer boxes and undermount soft closing slides
- Door and open shelf storage pedestals include a single adjustable height shelf
- Integrated pull includes a horizontal accent in which a finish must be specified; finish options include veneer, powdercoat, chrome accent, or clear anodized
- If a wood integrated pull (WIP) is selected on a veneer case with painted drawer fronts (VS), the finish of the wood on the integrated pull will default to the veneer of the case unless otherwise specified
- If a wood integrated pull (WIP) is selected on a painted case (S), the finish of the wood on the integrated pull will default to the paint color of the drawer unless otherwise specified
- Metal Tab Pull finish options include powdercoat, chrome, or clear anodized
- Box drawers include fabric wrapped drawer bottoms. Felt (K1207) or Hopsack (K1206) selection required. If no selection is made, the default choice will be Knoll Felt - Pewter.
- Face locking standard on all storage components
- The back of the integrated pull will reflect the wood or metal selection (see shaded area of drawing)
- Sliding door common cases do not have locks
- Open shelves are always at the opposite end designated by the handedness of the case (e.g., a left-handed case has open shelves on the right end of the case)
- When adding a grommet to a standard height common case, ensure the work surface also has a grommet location option selected
- Optional grommet placement: location is based on "L" or "T" shape
- Handedness is based on the open shelf location, facing the unit

REQUIRED INFORMATION (ORDER CANNOT BE ENTERED WITHOUT THIS INFORMATION)

- See appendix pages vi-viii for surface material options.
- Choose Veneer Finish, if applicable
 - Choose Metal Finish, if applicable
 - Choose Paint Finish, if applicable
 - Choose Pull option for Pedestals: Integrated Pull (-MIP or -WIP) or Metal Pull (-MP)
 - Choose Fabric option, if applicable



68.5" -HIGH TOWERS

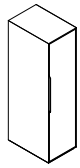

AAFW-1826-68
WARDROBE

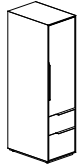

AABF-1826-68
BOX/FILE
WARDROBE

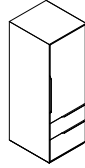

AABF2-2426-68
BOX/FILE
(2) ADJ SHELVES



AABBF-1826-68
BOX/BOX/FILE
WARDROBE

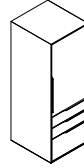

AABBF2-2426-68
BOX/BOX/FILE
(2) ADJ SHELVES



AAFF-1826-68
FILE/FILE
WARDROBE

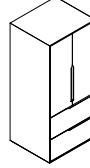

AAFF2-3026-68
FILE/FILE
WARDROBE
(2) ADJ SHELVES

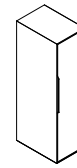

AABC-D-1826-68
STORAGE TOWER

SURFACE MATERIAL KEY

- S All Paint
- V Veneer
- VS Veneer Case and Painted Front

68.5" -HIGH TOWER

MODEL #	DEPTH	WIDTH	HEIGHT	DESCRIPTION	-S	-V	-VS
AAFW-1226-68-[]	26	12	68.5	Full-Height Wardrobe	5,548	5,843	5,843
AAFW-1826-68-[]	26	18	68.5	Full-Height Wardrobe	6,659	7,011	7,011
AAFW-2426-68-[]	26	24	68.5	Full-Height Wardrobe	7,770	8,179	8,179
AAFW-3026-68-[]	26	30	68.5	Double Door Wardrobe with Adjustable Shelves (4)	8,879	9,342	9,342
AAFW-3626-68-[]	26	36	68.5	Double Door Wardrobe with Adjustable Shelves (4)	9,988	10,512	10,512
AABF-1826-68-[]	26	18	68.5	Box / File with Upper Door - Wardrobe	8,339	8,778	8,778
AABF-2426-68-[]	26	24	68.5	Box / File with Upper Door - Wardrobe	9,213	9,696	9,696
AABF-3026-68-[]	26	30	68.5	Box / File with Double Upper Doors - Wardrobe and Adjustable Shelves (2)	8,339	8,778	8,778
AABF-3626-68-[]	26	36	68.5	Box / File with Double Upper Doors - Wardrobe and Adjustable Shelves (2)	9,213	9,696	9,696
AABF2-1826-68-[]	26	18	68.5	Box / File with Upper Door - Adjustable Shelves (2)	8,339	8,778	8,778
AABF2-2426-68-[]	26	24	68.5	Box / File with Upper Door - Adjustable Shelves (2)	9,213	9,696	9,696
AABF2-3026-68	26	30	68.5	Box / File with Double Upper Doors - Adjustable Shelves (2)	8,339	8,778	8,778
AABF2-3626-68	26	36	68.5	Box / File with Double Upper Doors - Adjustable Shelves (2)	9,213	9,696	9,696
AABBF-1826-68-[]	26	18	68.5	Box / Box / File with Upper Door - Wardrobe	8,008	8,428	8,428
AABBF-2426-68-[]	26	24	68.5	Box / Box / File with Upper Door - Wardrobe	8,879	9,342	9,342
AABBF-3026-68-[]	26	30	68.5	Box / Box / File with Double Upper Doors-Wardrobe and Adjustable Shelves (2)	8,008	8,428	8,428
AABBF-3626-68-[]	26	36	68.5	Box / Box / File with Double Upper Doors-Wardrobe and Adjustable Shelves (2)	8,879	9,342	9,342
AABBF2-1826-68-[]	26	18	68.5	Box / Box / File with Upper Door - Adjustable Shelves (2)	8,339	8,778	8,778
AABBF2-2426-68-[]	26	24	68.5	Box / Box / File with Upper Door - Adjustable Shelves (2)	9,213	9,696	9,696
AABBF2-3026-68	26	30	68.5	Box / Box / File with Double Upper Doors - Adjustable Shelves (2)	8,339	8,778	8,778
AABBF2-3626-68	26	36	68.5	Box / Box / File with Double Upper Doors - Adjustable Shelves (2)	9,213	9,696	9,696
AAFF-1826-68-[]	26	18	68.5	File / File with Upper Door - Wardrobe	8,008	8,428	8,428
AAFF-2426-68-[]	26	24	68.5	File / File with Upper Door - Wardrobe	8,879	9,342	9,342
AAFF-3026-68-[]	26	30	68.5	File/File with Double Upper Doors - Wardrobe and Adjustable Shelves (2)	8,008	8,428	8,428
AAFF-3626-68-[]	26	36	68.5	File/File with Double Upper Doors - Wardrobe and Adjustable Shelves (2)	8,879	9,342	9,342
AAFF2-1826-68-[]	26	18	68.5	File / File with Upper Door - Adjustable Shelves (2)	8,339	8,778	8,778
AAFF2-2426-68-[]	26	24	68.5	File / File with Upper Door - Adjustable Shelves (2)	9,213	9,696	9,696
AAFF2-3026-68	26	30	68.5	File / File with Double Upper Doors - Adjustable Shelves (2)	8,339	8,778	8,778
AAFF2-3626-68	26	36	68.5	File / File with Double Upper Doors - Adjustable Shelves (2)	9,213	9,696	9,696
AABC-D-1826-68-[]	26	18	68.5	Storage Tower with Door, 1 Fixed Shelf and Adjustable Shelves (3)	6,659	7,011	7,011
AABC-D-2426-68-[]	26	24	68.5	Storage Tower with Door, 1 Fixed Shelf and Adjustable Shelves (3)	7,770	8,179	8,179
AABC-D-3026-68	26	30	68.5	Storage Tower with Double Doors, 1 Fixed Shelf and Adjustable Shelves (3)	8,879	9,342	9,342
AABC-D-3626-68	26	36	68.5	Storage Tower with Double Doors, 1 Fixed Shelf and Adjustable Shelves (3)	9,988	10,512	10,512

- [] Specify Left (-L) or Right (-R)
- Relative to the hinge side of single door units
- Relative to side with wardrobe on double door units



68.5" -HIGH TOWERS

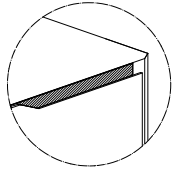

-MIP or -WIP

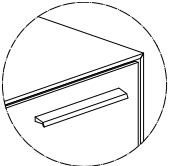

-MP

OPTIONS	CODE	PRICE	NOTES
Tower Locks:	-LO	\$320	
Pull Options:			
Integrated Pull (Metal Accent)	-MIP	No Charge	
Integrated Pull (Wood Accent)	-WIP	No Charge	
Metal Tab Pull	-MP	No Charge	
Polished Chrome Pulls	-PCP	\$650	per Pull

GENERAL INFORMATION

- Vertical grain direction
- Veneer species often dictates cut, default veneer cut is flat
- Towers are standard without locks
- 12" w wardrobe towers only include a hanging bar. There is no shoe tray or mirror.
- 18" w and 24" w wardrobe towers include hanger bar and mirror (13.5" w x 21" h). Full-height wardrobes also include a shoe tray.
- Shoe Tray is lined with rubber mat
- Freestanding 12" w towers must be fastened to the adjacent case
- 26" D towers include:
 - 1 fixed shelf - hat shelf above the wardrobe bar
 - The 68" h tower has 57" clearance from the wardrobe bar to the bottom panel
 - The 83.5" h tower has a 72" clearance from the wardrobe bar to the bottom panel
 - Lock option on the double door tower includes two locks - one each door
- Tower depth aligns with the work surface depth
- Integrated pull includes a horizontal accent in which a finish must be specified; finish options include veneer, powdercoat, chrome accent, or clear anodized
- If a wood integrated pull (WIP) is selected on a veneer case with painted drawer fronts (VS), the finish of the wood on the integrated pull will default to the veneer of the case unless otherwise specified
- If a wood integrated pull (WIP) is selected on a painted case (S), the finish of the wood on the integrated pull will default to the paint color of the drawer unless otherwise specified
- Metal Tab Pull finish options include powdercoat, chrome, or clear anodized
- Adjustable glides add 1/2" to overall height of the tower 68.5" h and 84" h
- The back of the integrated pull will reflect the wood or metal selection (see shaded area of drawing)
- Handedness is defined by the side of the hinges
- On double door wardrobe units (30 & 36" wide), handedness is defined by the wardrobe side

REQUIRED INFORMATION (ORDER CANNOT BE ENTERED WITHOUT THIS INFORMATION)

See appendix pages vi-viii for surface material options.

- Choose Veneer Finish, if applicable
- Choose Metal Finish, if applicable
- Choose Paint Finish, if applicable
- Choose Pull option for Towers: Integrated Pull (-MIP or -WIP) or Metal Pull (-MP)



84" -HIGH TOWERS

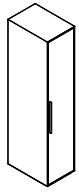

AAFW-1826-84
WARDROBE

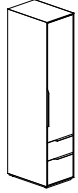

AABF-1826-84
BOX/FILE
WARDROBE



AABF2-2426-84
BOX/FILE
(2) ADJ SHELVES

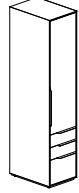

AABBF-1826-84
BOX/BOX/FILE
WARDROBE



AABBF2-2426-84
BOX/BOX/FILE
(2) ADJ SHELVES



AAFF-1826-84
FILE/FILE
WARDROBE

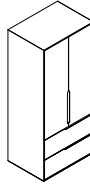

AAFF2-3626-84
FILE/FILE
WARDROBE
(2) ADJ SHELVES



AAFF2-3626-84
STORAGE TOWER

SURFACE MATERIAL KEY

- S All Paint
- V Veneer
- VS Veneer Case and Painted Front

84" -HIGH TOWER

MODEL #	DEPTH	WIDTH	HEIGHT	DESCRIPTION	-S	-V	-VS
AAFW-1226-84-[]	26	12	84	Full-Height Wardrobe with Upper Shelf	5,805	6,109	6,109
AAFW-1826-84-[]	26	18	84	Full-Height Wardrobe with Upper Shelf	6,966	7,334	7,334
AAFW-2426-84-[]	26	24	84	Full-Height Wardrobe with Upper Shelf	8,125	8,553	8,553
AAFW-3026-84-[]	26	30	84	Double Doors Wardrobe with Adjustable Shelves (5)	9,286	9,774	9,774
AAFW-3626-84-[]	26	36	84	Double Doors Wardrobe with Adjustable Shelves (5)	10,446	10,994	10,994
AABF-1826-84-[]	26	18	84	Box / File with Upper Door - Wardrobe	9,119	9,597	9,597
AABF-2426-84-[]	26	24	84	Box / File with Upper Door - Wardrobe	9,993	10,516	10,516
AABF-3026-84-[]	26	30	84	Box / File with Double Upper Doors-Wardrobe and Adjustable Shelves (3)	9,119	9,597	9,597
AABF-3626-84-[]	26	36	84	Box / File with Double Upper Doors-Wardrobe and Adjustable Shelves (3)	9,993	10,516	10,516
AABF2-1826-84-[]	26	18	84	Box / File with Upper Door - Adjustable Shelves (3)	9,119	9,597	9,597
AABF2-2426-84-[]	26	24	84	Box / File with Upper Door - Adjustable Shelves (3)	9,993	10,516	10,516
AABF2-3026-84	26	30	84	Box / File with Double Upper Doors - Adjustable Shelves (3)	9,119	9,597	9,597
AABF2-3626-84	26	36	84	Box / File with Double Upper Doors - Adjustable Shelves (3)	9,993	10,516	10,516
AABBF-1826-84-[]	26	18	84	Box / Box / File with Upper Door - Wardrobe	8,755	9,215	9,215
AABBF-2426-84-[]	26	24	84	Box / Box / File with Upper Door - Wardrobe	9,627	10,133	10,133
AABBF-3026-84-[]	26	30	84	Box / Box / File with Double Upper Doors-Wardrobe and Adjustable Shelves (3)	8,755	9,215	9,215
AABBF-3626-84-[]	26	36	84	Box / Box / File with Double Upper Doors-Wardrobe and Adjustable Shelves (3)	9,627	10,133	10,133
AABBF2-1826-84-[]	26	18	84	Box / Box / File with Upper Door - Adjustable Shelves (3)	9,119	9,597	9,597
AABBF2-2426-84-[]	26	24	84	Box / Box / File with Upper Door - Adjustable Shelves (3)	9,993	10,516	10,516
AABBF2-3026-84	26	30	84	Box / Box / File with Double Upper Doors - Adjustable Shelves (3)	9,119	9,597	9,597
AABBF2-3626-84	26	36	84	Box / Box / File with Double Upper Doors - Adjustable Shelves (3)	9,993	10,516	10,516
AAFF-1826-84-[]	26	18	84	File / File with Upper Door - Wardrobe	8,755	9,215	9,215
AAFF-2426-84-[]	26	24	84	File / File with Upper Door - Wardrobe	9,627	10,133	10,133
AAFF-3026-84-[]	26	30	84	File / File with Double Upper Doors - Wardrobe and Adjustable Shelves (3)	8,755	9,215	9,215
AAFF-3626-84-[]	26	36	84	File / File with Double Upper Doors - Wardrobe and Adjustable Shelves (3)	9,627	10,133	10,133
AAFF2-1826-84-[]	26	18	84	File / File with Upper Door - Adjustable Shelves (3)	9,119	9,597	9,597
AAFF2-2426-84-[]	26	24	84	File / File with Upper Door - Adjustable Shelves (3)	9,993	10,516	10,516
AAFF2-3026-84	26	30	84	File / File with Double Upper Doors - Adjustable Shelves (3)	9,119	9,597	9,597
AAFF2-3626-84	26	36	84	File / File with Double Upper Doors - Adjustable Shelves (3)	9,993	10,516	10,516
AABC-D-1826-84-[]	26	18	84	Storage Tower with Door, 1 Fixed Shelf and Adjustable Shelves (3)	6,966	7,334	7,334
AABC-D-2426-84-[]	26	24	84	Storage Tower with Door, 1 Fixed Shelf and Adjustable Shelves (3)	8,125	8,553	8,553
AABC-D-3026-84	26	30	84	Storage Tower with Double Doors, 1 Fixed Shelf and Adjustable Shelves (3)	9,286	9,774	9,774
AABC-D-3626-84	26	36	84	Storage Tower with Double Doors, 1 Fixed Shelf and Adjustable Shelves (3)	10,446	10,994	10,994

- [] Specify Left (-L) or Right (-R)
- Relative to the hinge side of single door units
- Relative to side with wardrobe on double door units



84" -HIGH TOWERS

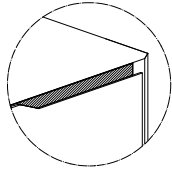

-MIP or -WIP

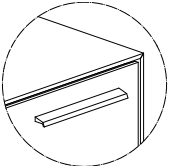

-MP

OPTIONS	CODE	PRICE	NOTES
Tower Locks:	-LO	\$320	
Pull Options:			
Integrated Pull (Metal Accent)	-MIP	No Charge	
Integrated Pull (Wood Accent)	-WIP	No Charge	
Metal Tab Pull	-MP	No Charge	
Polished Chrome Pulls	-PCP	\$650	per Pull

GENERAL INFORMATION

- Vertical grain direction
- Veneer species often dictates cut, default veneer cut is flat
- Towers are standard without locks
- 12" w wardrobe towers only include a hanging bar. There is no shoe tray or mirror.
- 18" w and 24" w wardrobe towers include hanger bar and mirror (13.5" w x 21" h). Full-height wardrobes also include a shoe tray.
- Shoe Tray is lined with rubber mat
- Freestanding 12" w towers must be fastened to the adjacent case
- 26" D towers include:
 - 1 fixed shelf - hat shelf above the wardrobe bar
 - The 68" h tower has 57" clearance from the wardrobe bar to the bottom panel
 - The 83.5" h tower has a 72" clearance from the wardrobe bar to the bottom panel
 - Lock option on the double door tower includes two locks - one each door
- Tower depth aligns with the work surface depth
- Integrated pull includes a horizontal accent in which a finish must be specified; finish options include veneer, powdercoat, chrome accent, or clear anodized
- If a wood integrated pull (WIP) is selected on a veneer case with painted drawer fronts (VS), the finish of the wood on the integrated pull will default to the veneer of the case unless otherwise specified
- If a wood integrated pull (WIP) is selected on a painted case (S), the finish of the wood on the integrated pull will default to the paint color of the drawer unless otherwise specified
- Metal Tab Pull finish options include powdercoat, chrome, or clear anodized
- Adjustable glides add 1/2" to overall height of the tower 68.5" h and 84" h
- The back of the integrated pull will reflect the wood or metal selection (see shaded area of drawing)
- Handedness is defined by the side of the hinges
- On double door wardrobe units (30 & 36" wide), handedness is defined by the wardrobe side

REQUIRED INFORMATION (ORDER CANNOT BE ENTERED WITHOUT THIS INFORMATION)

See appendix pages vi-viii for surface material options.

- Choose Veneer Finish, if applicable
- Choose Metal Finish, if applicable
- Choose Paint Finish, if applicable
- Choose Pull option for Towers: Integrated Pull (-MIP or -WIP) or Metal Pull (-MP)



17"-DEEP / SHALLOW TOWERS

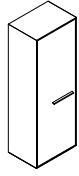

AAFW-2417-68
WARDROBE



AABC-D-2417-68
BOX/FILE
WARDROBE



AAFW-2417-84
BOX/FILE
(2) ADJ SHELVES

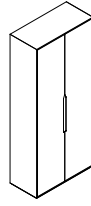

AABC-D-3617-84
BOX/BOX/FILE
WARDROBE

SURFACE MATERIAL KEY

- S All Paint
- V Veneer
- VS Veneer Case and Painted Front

68.5"-HIGH TOWER // SHALLOW DEPTH WARDROBE

MODEL #	DEPTH	WIDTH	HEIGHT	DESCRIPTION	-S	-V	-VS
AAFW-2417-68-[]	17	24	68.5	Single Door Wardrobe with Hat Shelf	6,216	6,541	6,541
AABC-D-1817-68-[]	17	18	68.5	Storage Tower with Door, (1) Fixed Shelf and (3) Adjustable Shelves	5,329	5,609	5,609
AABC-D-2417-68-[]	17	24	68.5	Storage Tower with Door, (1) Fixed Shelf and (3) Adjustable Shelves	6,216	6,541	6,541
AABC-D-3017-68	17	30	68.5	Double Door Storage Tower, (1) Fixed Shelf & (3) Adjustable Shelves	7,101	7,477	7,477
AABC-D-3617-68	17	36	68.5	Double Door Storage Tower, (1) Fixed Shelf & (3) Adjustable Shelves	7,989	8,409	8,409

84"-HIGH TOWER // SHALLOW DEPTH WARDROBE

MODEL #	DEPTH	WIDTH	HEIGHT	DESCRIPTION	-S	-V	-VS
AAFW-2417-84-[]	17	24	84	Single Door Wardrobe with Hat Shelf	6,501	6,842	6,842
AABC-D-1817-84-[]	17	18	84	Storage Tower with Door, (1) Fixed Shelf and (4) Adjustable Shelves	5,572	5,866	5,866
AABC-D-2417-84-[]	17	24	84	Storage Tower with Door, (1) Fixed Shelf and (4) Adjustable Shelves	6,501	6,842	6,842
AABC-D-3017-84	17	30	84	Double Door Storage Tower, (1) Fixed Shelf and (4) Adjustable Shelves	7,429	7,821	7,821
AABC-D-3617-84	17	36	84	Double Door Storage Tower, (1) Fixed Shelf and (4) Adjustable Shelves	8,358	8,798	8,798

[] Specify left or right relative to the hinge side of single door units



17" -DEEP / SHALLOW TOWERS

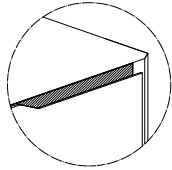

-MIP or -WIP

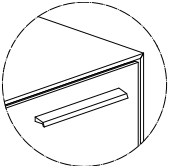

-MP

OPTIONS	CODE	PRICE	NOTES
Tower Locks:	-LO	\$320	
Pull Options:			
Integrated Pull (Metal Accent)	-MIP	No Charge	
Integrated Pull (Wood Accent)	-WIP	No Charge	
Metal Tab Pull	-MP	No Charge	
Polished Chrome Pulls	-PCP	\$650	per Pull

GENERAL INFORMATION

- Vertical grain direction
- Veneer species often dictates cut, default veneer cut is flat
- Towers are standard without locks
- 12" w wardrobe towers only include a hanging bar. There is no shoe tray or mirror.
- 18" w and 24" w wardrobe towers include hanger bar and mirror (13.5" w x 21" h). There is no shoe tray.
- Freestanding 12" w towers must be fastened to the adjacent case
- 17" D towers include:
 - 1 fixed shelf - hat shelf above the wardrobe bar
 - The 68" h tower has 57" clearance from the wardrobe bar to the bottom panel
 - The 83.5" h tower has a 72" clearance from the wardrobe bar to the bottom panel
 - Lock option on the double door tower includes two locks - one each door
- Tower depth aligns with Overhead case
- Integrated pull includes a horizontal accent in which a finish must be specified; finish options include veneer, powdercoat, chrome accent, or clear anodized
- If a wood integrated pull (WIP) is selected on a veneer case with painted drawer fronts (VS), the finish of the wood on the integrated pull will default to the veneer of the case unless otherwise specified
- If a wood integrated pull (WIP) is selected on a painted case (S), the finish of the wood on the integrated pull will default to the paint color of the drawer unless otherwise specified
- Metal Tab Pull finish options include powdercoat, chrome, or clear anodized
- Adjustable glides add 1/2" to overall height of the tower 68.5" h and 84" h
- The back of the integrated pull will reflect the wood or metal selection (see shaded area of drawing)

REQUIRED INFORMATION (ORDER CANNOT BE ENTERED WITHOUT THIS INFORMATION)

- See appendix pages vi-viii for surface material options.
- Choose Veneer Finish, if applicable
 - Choose Metal Finish, if applicable
 - Choose Paint Finish, if applicable
 - Choose Pull option for Towers: Integrated Pull (-MIP or -WIP) or Metal Pull (-MP)



FABRIC WALL PANEL

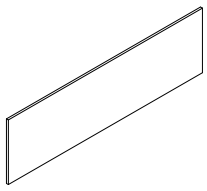

25.5" HIGH WALL PANELS

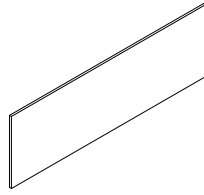

29" HIGH WALL PANELS

25.5" HIGH WALL PANELS

FOR USE WITH STANDARD HEIGHT WORK SURFACES WITH SINGLE OVERHEAD MOUNTED AT 68.5" OR DOUBLE HEIGHT OVERHEAD MOUNTED AT 84"

MODEL #	W X H	YARDAGE	COM	A	B	C	D	E	F	G	H
AATB-2425	24 x 25.5	1	434	524	559	610	653	700	745	792	854
AATB-3025	30 x 25.5	1	528	642	686	753	807	868	924	982	1,058
AATB-3625	36 x 25.5	2	617	758	812	891	960	1,031	1,099	1,170	1,257
AATB-4225	42 x 25.5	2	700	867	933	1,026	1,106	1,191	1,273	1,356	1,454
AATB-4825	48 x 25.5	2	782	971	1,050	1,160	1,251	1,350	1,442	1,538	1,645
AATB-5425	54 x 25.5	2	857	1,075	1,165	1,287	1,392	1,505	1,611	1,722	1,833
AATB-6025	60 x 25.5	2	926	1,170	1,277	1,412	1,529	1,657	1,775	1,898	2,017
AATB-6625	66 x 25.5	2	981	1,258	1,395	1,528	1,666	1,805	1,941	2,075	2,197
AATB-7225	72 x 25.5	3	1,037	1,340	1,494	1,646	1,795	1,948	2,101	2,254	2,374
AATB-7825	78 x 25.5	3	1,091	1,424	1,591	1,757	1,927	2,096	2,263	2,425	2,547
AATB-8425	84 x 25.5	3	1,136	1,504	1,685	1,872	2,044	2,233	2,420	2,594	2,715
AATB-9025	90 x 25.5	3	1,185	1,579	1,779	1,975	2,171	2,366	2,575	2,767	2,884
AATB-9625	96 x 25.5	3	1,224	1,651	1,861	2,075	2,287	2,507	2,713	2,927	3,045
AATB-10225	102 x 25.5	3	1,268	1,725	1,950	2,182	2,415	2,635	2,865	3,096	3,216
AATB-10825	108 x 25.5	4	1,304	1,790	2,036	2,278	2,517	2,765	3,004	3,252	3,369
AATB-11425	114 x 25.5	4	1,338	1,852	2,111	2,374	2,627	2,893	3,150	3,409	3,527
AATB-12025	120 x 25.5	4	1,369	1,917	2,193	2,468	2,742	3,015	3,291	3,560	3,681

29" HIGH WALL PANELS

FOR USE WITH LOW HEIGHT WORK SURFACES WITH SINGLE OVERHEAD MOUNTED AT 68.5" OR DOUBLE HEIGHT OVERHEAD MOUNTED AT 84"

MODEL #	W X H	YARDAGE	COM	A	B	C	D	E	F	G	H
AATB-2429	24 x 29	1	453	540	575	631	673	719	763	807	873
AATB-3029	30 x 29	1	551	660	711	777	833	887	943	1,002	1,078
AATB-3629	36 x 29	2	643	778	839	918	985	1,052	1,119	1,191	1,281
AATB-4229	42 x 29	2	729	890	964	1,057	1,137	1,218	1,299	1,381	1,481
AATB-4829	48 x 29	2	813	1,001	1,086	1,188	1,282	1,379	1,469	1,568	1,674
AATB-5429	54 x 29	2	890	1,104	1,201	1,322	1,424	1,534	1,641	1,750	1,863
AATB-6029	60 x 29	2	963	1,203	1,314	1,447	1,566	1,690	1,808	1,930	2,054
AATB-6629	66 x 29	2	1,019	1,296	1,435	1,566	1,706	1,843	1,980	2,117	2,236
AATB-7229	72 x 29	3	1,072	1,372	1,528	1,680	1,833	1,984	2,137	2,287	2,406
AATB-7829	78 x 29	3	1,127	1,463	1,626	1,795	1,965	2,131	2,299	2,464	2,586
AATB-8429	84 x 29	3	1,171	1,537	1,722	1,910	2,081	2,266	2,453	2,630	2,750
AATB-9029	90 x 29	3	1,219	1,612	1,812	2,009	2,206	2,401	2,608	2,802	2,925
AATB-9629	96 x 29	3	1,258	1,687	1,899	2,113	2,322	2,543	2,750	2,964	3,083
AATB-10229	102 x 29	3	1,304	1,764	1,989	2,218	2,451	2,673	2,898	3,130	3,250
AATB-10829	108 x 29	4	1,338	1,826	2,072	2,313	2,554	2,801	3,041	3,284	3,406
AATB-11429	114 x 29	4	1,369	1,888	2,149	2,406	2,664	2,867	3,244	3,441	3,560
AATB-12029	120 x 29	4	1,409	1,956	2,229	2,508	2,778	3,051	3,328	3,601	3,711

GENERAL INFORMATION

- Tackboards greater than 102" will have an even split two piece construction
- See page ix in the appendix for fabric restrictions
- Back panels extend 2" below work surface and rest upon the work surface supports
- Back panels above common case credenzas sit on the top of the credenza

REQUIRED INFORMATION (ORDER CANNOT BE ENTERED WITHOUT THIS INFORMATION)

See appendix pages vi-viii for surface material options.

- Choose Fabric option



FABRIC WALL PANEL

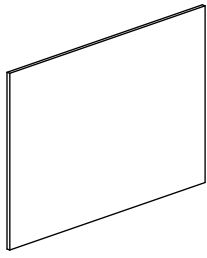

41" HIGH WALL PANELS

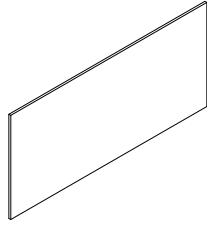

44.5" HIGH WALL PANELS

41" HIGH WALL PANELS

FOR USE WITH STANDARD HEIGHT WORK SURFACES WITH NO OVERHEAD (OVERALL HEIGHT OF 68.5") OR SINGLE OVERHEAD MOUNTED AT 84"

MODEL #	W X H	YARDAGE	COM	A	B	C	D	E	F	G	H
AATB-2441	24 x 41	1	583	667	708	763	809	845	902	934	1,004
AATB-3041	30 x 41	1	680	786	837	906	964	1,009	1,079	1,126	1,208
AATB-3641	36 x 41	2	768	901	963	1,044	1,116	1,177	1,257	1,314	1,408
AATB-4241	42 x 41	2	852	1,008	1,085	1,178	1,261	1,338	1,427	1,500	1,604
AATB-4841	48 x 41	2	933	1,116	1,201	1,308	1,409	1,494	1,599	1,682	1,795
AATB-5441	54 x 41	2	1,006	1,218	1,316	1,438	1,548	1,650	1,765	1,861	1,982
AATB-6041	60 x 41	2	1,077	1,314	1,426	1,562	1,687	1,802	1,930	2,042	2,169
AATB-6641	66 x 41	2	1,132	1,401	1,545	1,677	1,822	1,949	2,097	2,221	2,348
AATB-7241	72 x 41	3	1,186	1,482	1,644	1,798	1,952	2,090	2,260	2,397	2,520
AATB-7841	78 x 41	3	1,241	1,570	1,741	1,906	2,083	2,238	2,421	2,570	2,698
AATB-8441	84 x 41	3	1,286	1,646	1,834	2,019	2,200	2,375	2,575	2,742	2,865
AATB-9041	90 x 41	3	1,336	1,723	1,929	2,127	2,328	2,509	2,732	2,910	3,036
AATB-9641	96 x 41	3	1,373	1,792	2,014	2,226	2,441	2,651	2,870	3,071	3,194
AATB-10241	102 x 41	3	1,417	1,870	2,100	2,334	2,571	2,780	3,022	3,239	3,365
AATB-10841	108 x 41	4	1,455	1,934	2,186	2,428	2,675	2,908	3,162	3,397	3,521
AATB-11441	114 x 41	4	1,487	1,996	2,261	2,520	2,785	3,037	3,305	3,553	3,678
AATB-12041	120 x 41	4	1,522	2,061	2,342	2,618	2,897	3,158	3,447	3,706	3,830

44.5" HIGH WALL PANELS

FOR USE WITH LOW HEIGHT WORK SURFACES WITH NO OVERHEAD (OVERALL HEIGHT OF 68.5") OR SINGLE OVERHEAD MOUNTED AT 84"

MODEL #	W X H	YARDAGE	COM	A	B	C	D	E	F	G	H
AATB-2444	24 x 44.5	1	603	682	726	779	831	860	917	949	1,022
AATB-3044	30 x 44.5	1	699	804	861	926	988	1,029	1,100	1,144	1,227
AATB-3644	36 x 44.5	2	796	923	988	1,070	1,143	1,197	1,279	1,336	1,431
AATB-4244	42 x 44.5	2	882	1,035	1,115	1,205	1,295	1,360	1,455	1,525	1,629
AATB-4844	48 x 44.5	2	964	1,143	1,235	1,341	1,441	1,522	1,625	1,709	1,822
AATB-5444	54 x 44.5	2	1,043	1,247	1,350	1,469	1,583	1,676	1,800	1,894	2,015
AATB-6044	60 x 44.5	2	1,112	1,345	1,464	1,597	1,723	1,832	1,965	2,074	2,200
AATB-6644	66 x 44.5	2	1,167	1,439	1,583	1,717	1,861	1,987	2,135	2,262	2,386
AATB-7244	72 x 44.5	3	1,223	1,514	1,677	1,830	1,989	2,128	2,294	2,429	2,555
AATB-7844	78 x 44.5	3	1,277	1,606	1,779	1,946	2,121	2,275	2,456	2,608	2,736
AATB-8444	84 x 44.5	3	1,323	1,682	1,872	2,058	2,237	2,410	2,610	2,774	2,901
AATB-9044	90 x 44.5	3	1,369	1,755	1,962	2,156	2,361	2,546	2,765	2,947	3,074
AATB-9644	96 x 44.5	3	1,409	1,830	2,052	2,263	2,478	2,684	2,908	3,108	3,234
AATB-10244	102 x 44.5	3	1,455	1,910	2,141	2,367	2,605	2,817	3,054	3,274	3,402
AATB-10844	108 x 44.5	4	1,487	1,971	2,222	2,464	2,710	2,945	3,197	3,429	3,556
AATB-11444	114 x 44.5	4	1,522	2,030	2,297	2,555	2,823	3,012	3,400	3,586	3,711
AATB-12044	120 x 44.5	4	1,560	2,100	2,380	2,657	2,935	3,194	3,485	3,747	3,863

GENERAL INFORMATION

- Tackboards greater than 102" will have an even split two piece construction
- See page ix in the appendix for fabric restrictions
- Back panels extend 2" below work surface and rest upon the work surface supports
- Back panels above common case credenzas sit on the top of the credenza

REQUIRED INFORMATION (ORDER CANNOT BE ENTERED WITHOUT THIS INFORMATION)

See appendix pages vi-viii for surface material options.

- Choose Fabric option



MAGNETIC GLASS WALL PANEL

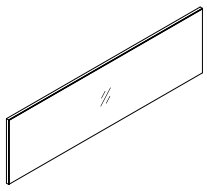

25.5" HIGH WALL PANELS

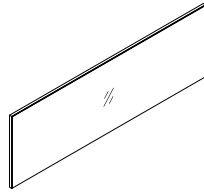

29" HIGH WALL PANELS

25.5" HIGH WALL PANELS

FOR USE WITH STANDARD HEIGHT WORK SURFACES WITH SINGLE OVERHEAD MOUNTED AT 68.5" OR DOUBLE HEIGHT OVERHEAD MOUNTED AT 84"

MODEL #	W X H	PRICE
AAGB-2425	24 x 25.5	1,781
AAGB-3025	30 x 25.5	2,193
AAGB-3625	36 x 25.5	2,588
AAGB-4225	42 x 25.5	2,970
AAGB-4825	48 x 25.5	3,339
AAGB-5425	54 x 25.5	3,692
AAGB-6025	60 x 25.5	4,032
AAGB-6625	66 x 25.5	4,198
AAGB-7225	72 x 25.5	4,365
AAGB-7825	78 x 25.5	4,752
AAGB-8425	84 x 25.5	5,138
AAGB-9025	90 x 25.5	5,550
AAGB-9625	96 x 25.5	5,966
AAGB-10225	102 x 25.5	6,156
AAGB-10825	108 x 25.5	6,342
AAGB-11425	114 x 25.5	6,536
AAGB-12025	120 x 25.5	6,721

29" HIGH WALL PANELS

FOR USE WITH LOW HEIGHT WORK SURFACES WITH SINGLE OVERHEAD MOUNTED AT 68.5" OR DOUBLE HEIGHT OVERHEAD MOUNTED AT 84"

MODEL #	W X H	PRICE
AAGB-2429	24 x 29	1,825
AAGB-3029	30 x 29	2,246
AAGB-3629	36 x 29	2,653
AAGB-4229	42 x 29	3,042
AAGB-4829	48 x 29	3,420
AAGB-5429	54 x 29	3,782
AAGB-6029	60 x 29	4,130
AAGB-6629	66 x 29	4,299
AAGB-7229	72 x 29	4,475
AAGB-7829	78 x 29	4,869
AAGB-8429	84 x 29	5,261
AAGB-9029	90 x 29	5,686
AAGB-9629	96 x 29	6,111
AAGB-10229	102 x 29	6,304
AAGB-10829	108 x 29	6,501
AAGB-11429	114 x 29	6,694
AAGB-12029	120 x 29	6,882

GENERAL INFORMATION

- Glass magnetic boards greater than 108" will have an even split two-piece construction
- Glass magnetic boards are only available in gloss finish
- Back-painted glass is low iron glass
- Magnets are included with the glass and veneer magnetic boards
- Back panels extend 2" below work surface and rest upon the work surface supports
- Back panels above common case credenzas sit on the top of the credenza
- Back panels always match case finish

REQUIRED INFORMATION (ORDER CANNOT BE ENTERED WITHOUT THIS INFORMATION)

- See appendix pages vi-viii for surface material options.
- Choose Paint Finish, if applicable



MAGNETIC GLASS WALL PANEL

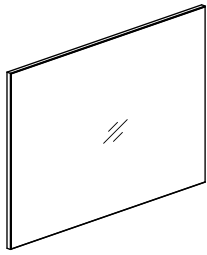

41" HIGH WALL PANELS

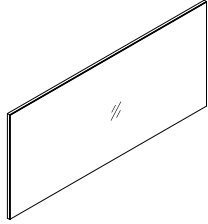

44.5" HIGH WALL PANELS

41" HIGH WALL PANELS

FOR USE WITH STANDARD HEIGHT WORK SURFACES WITH NO OVERHEAD (OVERALL HEIGHT OF 68.5") OR SINGLE OVERHEAD MOUNTED AT 84"

MODEL #	W X H	PRICE
AAGB-2441	24 x 41	2,219
AAGB-3041	30 x 41	2,636
AAGB-3641	36 x 41	3,045
AAGB-4241	42 x 41	3,436
AAGB-4841	48 x 41	3,810
AAGB-5441	54 x 41	4,174
AAGB-6041	60 x 41	4,520
AAGB-6641	66 x 41	4,692
AAGB-7241	72 x 41	4,865
AAGB-7841	78 x 41	5,261
AAGB-8441	84 x 41	5,654
AAGB-9041	90 x 41	6,079
AAGB-9641	96 x 41	6,503
AAGB-10241	102 x 41	6,698
AAGB-10841	108 x 41	6,894
AAGB-11441	114 x 41	7,084
AAGB-12041	120 x 41	7,275

44.5" HIGH WALL PANELS

FOR USE WITH LOW HEIGHT WORK SURFACES WITH NO OVERHEAD (OVERALL HEIGHT OF 68.5") OR SINGLE OVERHEAD MOUNTED AT 84"

MODEL #	W X H	PRICE
AAGB-2444	24 x 44.5	2,406
AAGB-3044	30 x 44.5	2,815
AAGB-3644	36 x 44.5	3,209
AAGB-4244	42 x 44.5	3,591
AAGB-4844	48 x 44.5	3,959
AAGB-5444	54 x 44.5	4,315
AAGB-6044	60 x 44.5	4,653
AAGB-6644	66 x 44.5	4,818
AAGB-7244	72 x 44.5	4,987
AAGB-7844	78 x 44.5	5,373
AAGB-8444	84 x 44.5	5,761
AAGB-9044	90 x 44.5	6,172
AAGB-9644	96 x 44.5	6,586
AAGB-10244	102 x 44.5	6,779
AAGB-10844	108 x 44.5	6,963
AAGB-11444	114 x 44.5	7,155
AAGB-12044	120 x 44.5	7,342

GENERAL INFORMATION

- Glass magnetic boards greater than 108" will have an even split two-piece construction
- Glass magnetic boards are only available in gloss finish
- Back-painted glass is low iron glass
- Magnets are included with the glass and veneer magnetic boards
- Back panels extend 2" below work surface and rest upon the work surface supports
- Back panels above common case credenzas sit on the top of the credenza
- Back panels always match case finish

REQUIRED INFORMATION (ORDER CANNOT BE ENTERED WITHOUT THIS INFORMATION)

- See appendix pages vi-viii for surface material options.
- Choose Paint Finish, if applicable



MAGNETIC GLASS WALL PANEL

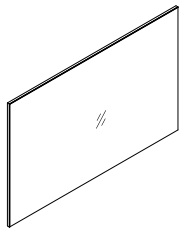

56.5" HIGH WALL PANELS

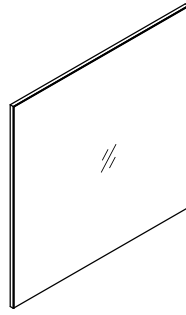

60" HIGH WALL PANELS

56.5" HIGH WALL PANELS

FOR USE WITH STANDARD HEIGHT WORK SURFACES WITH NO OVERHEAD (OVERALL HEIGHT OF 84")

MODEL #	W X H	PRICE
AAGB-2456	24 x 56.5	2,797
AAGB-3056	30 x 56.5	3,207
AAGB-3656	36 x 56.5	3,602
AAGB-4256	42 x 56.5	3,986
AAGB-4856	48 x 56.5	4,355
AAGB-5456	54 x 56.5	4,708
AAGB-6056	60 x 56.5	5,046
AAGB-6656	66 x 56.5	5,211
AAGB-7256	72 x 56.5	5,381
AAGB-7856	78 x 56.5	5,769
AAGB-8456	84 x 56.5	6,154
AAGB-9056	90 x 56.5	6,567
AAGB-9656	96 x 56.5	6,979
AAGB-10256	102 x 56.5	7,173
AAGB-10856	108 x 56.5	7,356
AAGB-11456	114 x 56.5	7,550
AAGB-12056	120 x 56.5	7,737

60" HIGH WALL PANELS

FOR USE WITH LOW HEIGHT WORK SURFACES WITH NO OVERHEAD (OVERALL HEIGHT OF 84")

MODEL #	W X H	PRICE
AAGB-2460	24 x 60	2,911
AAGB-3060	30 x 60	3,321
AAGB-3660	36 x 60	3,718
AAGB-4260	42 x 60	4,100
AAGB-4860	48 x 60	4,470
AAGB-5460	54 x 60	4,821
AAGB-6060	60 x 60	5,163
AAGB-6660	66 x 60	5,327
AAGB-7260	72 x 60	5,494
AAGB-7860	78 x 60	5,883
AAGB-8460	84 x 60	6,269
AAGB-9060	90 x 60	6,680
AAGB-9660	96 x 60	7,096
AAGB-10260	102 x 60	7,286
AAGB-10860	108 x 60	7,474
AAGB-11460	114 x 60	7,664
AAGB-12060	120 x 60	7,851

GENERAL INFORMATION

- Glass magnetic boards greater than 108" will have an even split two-piece construction
- Glass magnetic boards are only available in gloss finish
- Back-painted glass is low iron glass
- Magnets are included with the glass and veneer magnetic boards
- Back panels extend 2" below work surface and rest upon the work surface supports
- Back panels above common case credenzas sit on the top of the credenza
- Back panels always match case finish

REQUIRED INFORMATION (ORDER CANNOT BE ENTERED WITHOUT THIS INFORMATION)

See appendix pages vi-viii for surface material options.

- Choose Paint Finish, if applicable



MAGNETIC VENEER WALL PANEL

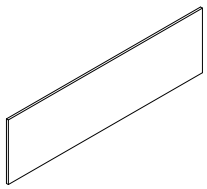

25.5" HIGH WALL PANELS

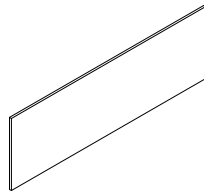

29" HIGH WALL PANELS

25.5" HIGH WALL PANELS

FOR USE WITH STANDARD HEIGHT WORK SURFACES WITH SINGLE OVERHEAD MOUNTED AT 68.5" OR DOUBLE HEIGHT OVERHEAD MOUNTED AT 84"

MODEL #	W X H	PRICE
AAVB-2425	24 x 25.5	1,249
AAVB-3025	30 x 25.5	1,535
AAVB-3625	36 x 25.5	1,814
AAVB-4225	42 x 25.5	2,081
AAVB-4825	48 x 25.5	2,338
AAVB-5425	54 x 25.5	2,587
AAVB-6025	60 x 25.5	2,824
AAVB-6625	66 x 25.5	2,939
AAVB-7225	72 x 25.5	3,055
AAVB-7825	78 x 25.5	3,327
AAVB-8425	84 x 25.5	3,599
AAVB-9025	90 x 25.5	3,888
AAVB-9625	96 x 25.5	4,176
AAVB-10225	102 x 25.5	4,311
AAVB-10825	108 x 25.5	4,441
AAVB-11425	114 x 25.5	4,574
AAVB-12025	120 x 25.5	4,707

29" HIGH WALL PANELS

FOR USE WITH LOW HEIGHT WORK SURFACES WITH SINGLE OVERHEAD MOUNTED AT 68.5" OR DOUBLE HEIGHT OVERHEAD MOUNTED AT 84"

MODEL #	W X H	PRICE
AAVB-2429	24 x 29	1,279
AAVB-3029	30 x 29	1,573
AAVB-3629	36 x 29	1,857
AAVB-4229	42 x 29	2,130
AAVB-4829	48 x 29	2,394
AAVB-5429	54 x 29	2,649
AAVB-6029	60 x 29	2,892
AAVB-6629	66 x 29	3,012
AAVB-7229	72 x 29	3,132
AAVB-7829	78 x 29	3,409
AAVB-8429	84 x 29	3,683
AAVB-9029	90 x 29	3,981
AAVB-9629	96 x 29	4,281
AAVB-10229	102 x 29	4,414
AAVB-10829	108 x 29	4,554
AAVB-11429	114 x 29	4,686
AAVB-12029	120 x 29	4,818

GENERAL INFORMATION

- Vertical grain direction
- Veneer species often dictates cut, default veneer cut is flat
- Back panels extend 2" below work surface and rest upon the work surface supports
- Back panels above common case credenzas sit on the top of the credenza

REQUIRED INFORMATION (ORDER CANNOT BE ENTERED WITHOUT THIS INFORMATION)

See appendix pages vi-viii for surface material options.

- Choose Veneer Finish, if applicable



MAGNETIC VENEER WALL PANELS

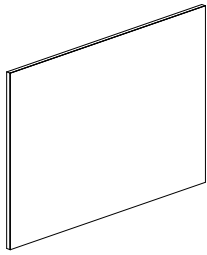

41" HIGH WALL PANELS

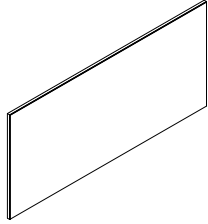

44.5" HIGH WALL PANELS

41" HIGH WALL PANELS

FOR USE WITH STANDARD HEIGHT WORK SURFACES WITH NO OVERHEAD (OVERALL HEIGHT OF 68.5") OR SINGLE OVERHEAD MOUNTED AT 84"

MODEL #	W X H	PRICE
AAVB-2441	24 x 41	1,554
AAVB-3041	30 x 41	1,849
AAVB-3641	36 x 41	2,131
AAVB-4241	42 x 41	2,406
AAVB-4841	48 x 41	2,670
AAVB-5441	54 x 41	2,925
AAVB-6041	60 x 41	3,166
AAVB-6641	66 x 41	3,284
AAVB-7241	72 x 41	3,407
AAVB-7841	78 x 41	3,683
AAVB-8441	84 x 41	3,958
AAVB-9041	90 x 41	4,256
AAVB-9641	96 x 41	4,555
AAVB-10241	102 x 41	4,690
AAVB-10841	108 x 41	4,828
AAVB-11441	114 x 41	4,959
AAVB-12041	120 x 41	5,095

44.5" HIGH WALL PANELS

FOR USE WITH LOW HEIGHT WORK SURFACES WITH NO OVERHEAD (OVERALL HEIGHT OF 68.5") OR SINGLE OVERHEAD MOUNTED AT 84"

MODEL #	W X H	PRICE
AAVB-2444	24 x 44.5	1,685
AAVB-3044	30 x 44.5	1,971
AAVB-3644	36 x 44.5	2,249
AAVB-4244	42 x 44.5	2,515
AAVB-4844	48 x 44.5	2,773
AAVB-5444	54 x 44.5	3,021
AAVB-6044	60 x 44.5	3,260
AAVB-6644	66 x 44.5	3,373
AAVB-7244	72 x 44.5	3,490
AAVB-7844	78 x 44.5	3,762
AAVB-8444	84 x 44.5	4,034
AAVB-9044	90 x 44.5	4,324
AAVB-9644	96 x 44.5	4,612
AAVB-10244	102 x 44.5	4,748
AAVB-10844	108 x 44.5	4,877
AAVB-11444	114 x 44.5	5,012
AAVB-12044	120 x 44.5	5,139

GENERAL INFORMATION

- Vertical grain direction
- Veneer species often dictates cut, default veneer cut is flat
- Back panels extend 2" below work surface and rest upon the work surface supports
- Back panels above common case credenzas sit on the top of the credenza

REQUIRED INFORMATION (ORDER CANNOT BE ENTERED WITHOUT THIS INFORMATION)

See appendix pages vi-viii for surface material options.

- Choose Veneer Finish, if applicable



MAGNETIC VENEER WALL PANELS

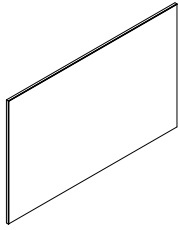

56.5" HIGH WALL PANELS

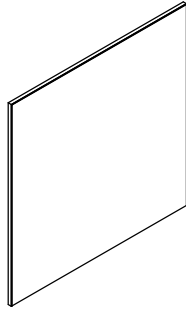

60" HIGH WALL PANELS

56.5" HIGH WALL PANELS

FOR USE WITH STANDARD HEIGHT WORK SURFACES WITH NO OVERHEAD (OVERALL HEIGHT OF 84")

MODEL #	W X H	PRICE
AAVB-2456	24 x 56.5	1,960
AAVB-3056	30 x 56.5	2,246
AAVB-3656	36 x 56.5	2,520
AAVB-4256	42 x 56.5	2,790
AAVB-4856	48 x 56.5	3,047
AAVB-5456	54 x 56.5	3,298
AAVB-6056	60 x 56.5	3,531
AAVB-6656	66 x 56.5	3,648
AAVB-7256	72 x 56.5	3,766
AAVB-7856	78 x 56.5	4,038
AAVB-8456	84 x 56.5	4,311
AAVB-9056	90 x 56.5	4,598
AAVB-9656	96 x 56.5	4,886
AAVB-10256	102 x 56.5	5,022
AAVB-10856	108 x 56.5	5,152
AAVB-11456	114 x 56.5	5,287
AAVB-12056	120 x 56.5	5,417

60" HIGH WALL PANELS

FOR USE WITH LOW HEIGHT WORK SURFACES WITH NO OVERHEAD (OVERALL HEIGHT OF 84")

MODEL #	W X H	PRICE
AAVB-2460	24 x 60	2,038
AAVB-3060	30 x 60	2,327
AAVB-3660	36 x 60	2,603
AAVB-4260	42 x 60	2,870
AAVB-4860	48 x 60	3,129
AAVB-5460	54 x 60	3,377
AAVB-6060	60 x 60	3,615
AAVB-6660	66 x 60	3,731
AAVB-7260	72 x 60	3,846
AAVB-7860	78 x 60	4,119
AAVB-8460	84 x 60	4,392
AAVB-9060	90 x 60	4,678
AAVB-9660	96 x 60	4,968
AAVB-10260	102 x 60	5,100
AAVB-10860	108 x 60	5,232
AAVB-11460	114 x 60	5,367
AAVB-12060	120 x 60	5,497

GENERAL INFORMATION

- Vertical grain direction
- Veneer species often dictates cut, default veneer cut is flat
- Back panels extend 2" below work surface and rest upon the work surface supports
- Back panels above common case credenzas sit on the top of the credenza

REQUIRED INFORMATION (ORDER CANNOT BE ENTERED WITHOUT THIS INFORMATION)

See appendix pages vi-viii for surface material options.

- Choose Veneer Finish, if applicable



ASCARI SERIES STORAGE SHELVES AND WALL PANEL

SURFACE MATERIAL KEY

S Painted Wall Panel
V Veneer Wall Panel

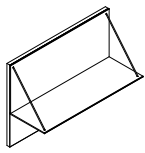

AAS1-3625

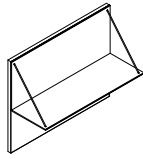

AAS1-3629

FOR USE BELOW A SINGLE 68.5" H OR DOUBLE 84" H OVERHEAD

MODEL #	DEPTH	WIDTH	HEIGHT	DESCRIPTION	-S	-V
AAS1-2425	13.7	24	25.5	Ascari Series Single Metal 24" W Storage Shelf	1,356	1,417
AAS1-3025	13.7	30	25.5	Ascari Series Single Metal 30" W Storage Shelf	1,626	1,705
AAS1-3625	13.7	36	25.5	Ascari Series Single Metal 36" W Storage Shelf	1,893	1,982
AAS1-2429	13.7	24	29	Ascari Series Single Metal 24" W Storage Shelf	1,385	1,449
AAS1-3029	13.7	30	29	Ascari Series Single Metal 30" W Storage Shelf	1,664	1,741
AAS1-3629	13.7	36	29	Ascari Series Single Metal 36" W Storage Shelf	1,934	2,028

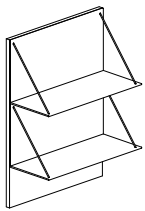

AAS2-3641

FOR USE WITH STANDARD HEIGHT WORK SURFACE WITH NO OVERHEAD, 68.5" H OVERHEAD, OR SINGLE HEIGHT OVERHEAD MOUNTED AT 84"

MODEL #	DEPTH	WIDTH	HEIGHT	DESCRIPTION	-S	-V
AAS2-2441	13.7	24	41	Ascari Series Double Stacked 24" W Metal Storage Shelves	1,816	1,894
AAS2-3041	13.7	30	41	Ascari Series Double Stacked 30" W Metal Storage Shelves	2,096	2,190
AAS2-3641	13.7	36	41	Ascari Series Double Stacked 36" W Metal Storage Shelves	2,366	2,474

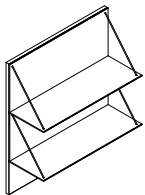

AAS2-3644

FOR USE WITH LOW HEIGHT WORK SURFACE WITH NO OVERHEAD, 68.5" H OVERHEAD, OR SINGLE HEIGHT OVERHEAD MOUNTED AT 84"

MODEL #	DEPTH	WIDTH	HEIGHT	DESCRIPTION	-S	-V
AAS2-2444	13.7	24	44	Ascari Series Double Stacked 24" W Metal Storage Shelves	1,938	2,024
AAS2-3044	13.7	30	44	Ascari Series Double Stacked 30" W Metal Storage Shelves	2,211	2,311
AAS2-3644	13.7	36	44	Ascari Series Double Stacked 36" W Metal Storage Shelves	2,475	2,588



ASCARI SERIES STORAGE SHELVES AND WALL PANEL

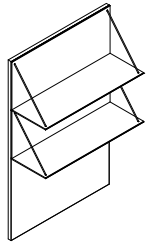

AAS2-3656

SURFACE MATERIAL KEY

S Painted Wall Panel
V Veneer Wall Panel

FOR USE WITH STANDARD HEIGHT WORK SURFACE WITH NO OVERHEAD, 84" OVERALL HEIGHT

MODEL #	DEPTH	WIDTH	HEIGHT	DESCRIPTION	-S	-V
AAS2-2456	13.7	24	56.5	Ascari Series Double Stacked 24"W Metal Storage Shelves	2,199	2,299
AAS2-3056	13.7	30	56.5	Ascari Series Double Stacked 30"W Metal Storage Shelves	2,474	2,586
AAS2-3656	13.7	36	56.5	Ascari Series Double Stacked 36"W Metal Storage Shelves	2,737	2,862

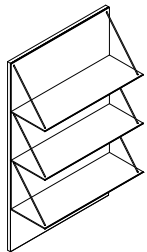

AAS3-3660

FOR USE WITH LOW HEIGHT WORK SURFACE WITH NO OVERHEAD, 84" OVERALL HEIGHT

MODEL #	DEPTH	WIDTH	HEIGHT	DESCRIPTION	-S	-V
AAS3-2460	13.7	24	60	Ascari Series Triple Stacked 24"W Metal Storage Shelves	2,447	2,547
AAS3-3060	13.7	30	60	Ascari Series Triple Stacked 30"W Metal Storage Shelves	2,717	2,834
AAS3-3660	13.7	36	60	Ascari Series Triple Stacked 36"W Metal Storage Shelves	2,982	3,112

OPTIONS	CODE	PRICE	NOTES
Polished Chrome Book Ends:	-PCBE	No Charge	

GENERAL INFORMATION

- Vertical grain direction
- Veneer species often dictates cut, default veneer cut is flat
- Storage shelf may not be positioned above a height adjustable work surface
- Usable storage shelf depth is 12.7"
- Wire book ends only on Ascari Series metal shelves
- Angled wire book ends require a metal finish selection powder coat or polished chrome
- Angled rod book ends are inset 1" from both the end and front edge of the shelf
- Storage shelves are not available with a tasklight
- Metal shelves and vertical back panel are only available in clear anodized
- The storage shelves are attached to a wall panel that can be finished in either veneer or paint. This wall panel below the bottom shelf will be exposed.

REQUIRED INFORMATION (ORDER CANNOT BE ENTERED WITHOUT THIS INFORMATION)
 See appendix pages vi-viii for surface material options.

- Choose Veneer Finish
- Choose Paint Finish, if applicable



METAL STORAGE SHELVES AND WALL PANEL

SURFACE MATERIAL KEY

S Painted Wall Panel
V Veneer Wall Panel

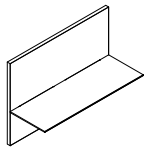

AAM1-3625

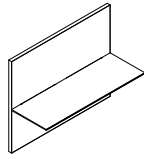

AAM1-3629

FOR USE BELOW A SINGLE 68.5" H OR DOUBLE 84" H OVERHEAD

MODEL #	DEPTH	WIDTH	HEIGHT	DESCRIPTION	-S	-V
AAM1-2425	13.7	24	25.5	Single Metal 24"W Storage Shelf	1,186	1,249
AAM1-3025	13.7	30	25.5	Single Metal 30"W Storage Shelf	1,458	1,535
AAM1-3625	13.7	36	25.5	Single Metal 36"W Storage Shelf	1,723	1,814
AAM1-2429	13.7	24	29	Single Metal 24"W Storage Shelf	1,217	1,279
AAM1-3029	13.7	30	29	Single Metal 30"W Storage Shelf	1,495	1,573
AAM1-3629	13.7	36	29	Single Metal 36"W Storage Shelf	1,764	1,857

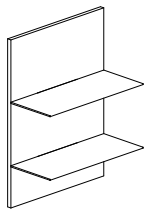

AAM2-3641

FOR USE WITH STANDARD HEIGHT WORK SURFACE WITH NO OVERHEAD, 68.5" H OVERHEAD, OR SINGLE HEIGHT OVERHEAD MOUNTED AT 84"

MODEL #	DEPTH	WIDTH	HEIGHT	DESCRIPTION	-S	-V
AAM2-2441	13.7	24	41	Double Stacked 24"W Metal Storage Shelves	1,478	1,554
AAM2-3041	13.7	30	41	Double Stacked 30"W Metal Storage Shelves	1,757	1,849
AAM2-3641	13.7	36	41	Double Stacked 36"W Metal Storage Shelves	2,028	2,131

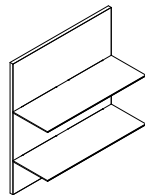

AAM2-3644

FOR USE WITH LOW HEIGHT WORK SURFACE WITH NO OVERHEAD, 68.5" H OVERHEAD, OR SINGLE HEIGHT OVERHEAD MOUNTED AT 84"

MODEL #	DEPTH	WIDTH	HEIGHT	DESCRIPTION	-S	-V
AAM2-2444	13.7	24	44	Double Stacked 24"W Metal Storage Shelves	1,601	1,685
AAM2-3044	13.7	30	44	Double Stacked 30"W Metal Storage Shelves	1,873	1,971
AAM2-3644	13.7	36	44	Double Stacked 36"W Metal Storage Shelves	2,135	2,249



METAL STORAGE SHELVES AND WALL PANEL

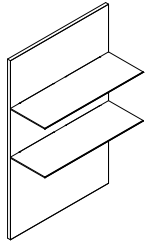

AAM2-3657

SURFACE MATERIAL KEY

- S Painted Wall Panel
- V Veneer Wall Panel

FOR USE WITH STANDARD HEIGHT WORK SURFACE WITH NO OVERHEAD, 84" OVERALL HEIGHT

MODEL #	DEPTH	WIDTH	HEIGHT	DESCRIPTION	-S	-V
AAM2-2457	13.7	24	56.5	Double Stacked 24"W Metal Storage Shelves	1,860	1,960
AAM2-3057	13.7	30	56.5	Double Stacked 30"W Metal Storage Shelves	2,133	2,246
AAM2-3657	13.7	36	56.5	Double Stacked 36"W Metal Storage Shelves	2,397	2,520

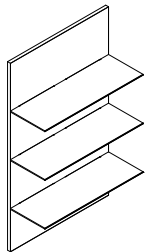

AAM3-3660

FOR USE WITH LOW HEIGHT WORK SURFACE WITH NO OVERHEAD, 84" OVERALL HEIGHT

MODEL #	DEPTH	WIDTH	HEIGHT	DESCRIPTION	-S	-V
AAM3-2460	13.7	24	60	Triple Stacked 24"W Metal Storage Shelves	1,937	2,038
AAM3-3060	13.7	30	60	Triple Stacked 30"W Metal Storage Shelves	2,210	2,327
AAM3-3660	13.7	36	60	Triple Stacked 36"W Metal Storage Shelves	2,474	2,603

GENERAL INFORMATION

- Storage shelf may not be positioned above a height adjustable work surface
- Usable storage shelf depth is 12.7"
- Wire book ends only on Ascari Series metal shelves
- Storage shelves are not available with a tasklight
- Metal storage shelves are 1/4"-thick
- Metal storage shelves are only available in clear anodized
- The storage shelves are attached to a wall panel that can be finished in either veneer or paint. This wall panel below the bottom shelf will be exposed.

REQUIRED INFORMATION (ORDER CANNOT BE ENTERED WITHOUT THIS INFORMATION)

See appendix pages vi-viii for surface material options.

- Choose Veneer Finish
- Choose Metal Finish, if applicable
- Choose Paint Finish, if applicable



WOOD STORAGE SHELVES AND WALL PANEL

SURFACE MATERIAL KEY

S Painted Wall Panel
V Veneer Wall Panel

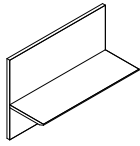

AAW1-3625

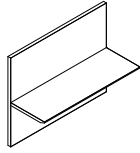

AAW1-3629

FOR USE BELOW A SINGLE 68.5" H OR DOUBLE 84" H OVERHEAD

MODEL #	DEPTH	WIDTH	HEIGHT	DESCRIPTION	-S	-V
AAW1-2425	13.7	24	25.5	Single wood 24"W storage shelf	949	1,001
AAW1-3025	13.7	30	25.5	Single wood 30"W storage shelf	1,167	1,227
AAW1-3625	13.7	36	25.5	Single wood 36"W storage shelf	1,380	1,453
AAW1-2429	13.7	24	29	Single wood 24"W storage shelf	972	1,023
AAW1-3029	13.7	30	29	Single wood 30"W storage shelf	1,197	1,259
AAW1-3629	13.7	36	29	Single wood 36"W storage shelf	1,414	1,485

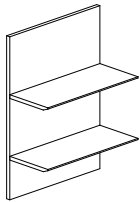

AAW2-3641

FOR USE WITH STANDARD HEIGHT WORK SURFACE WITH NO OVERHEAD, 68.5" H OVERHEAD, OR SINGLE HEIGHT OVERHEAD MOUNTED AT 84"

MODEL #	DEPTH	WIDTH	HEIGHT	DESCRIPTION	-S	-V
AAW2-2441	13.7	24	41	Double stacked wood 24"W storage shelves	1,183	1,245
AAW2-3041	13.7	30	41	Double stacked wood 30"W storage shelves	1,407	1,480
AAW2-3641	13.7	36	41	Double stacked wood 36"W storage shelves	1,620	1,706

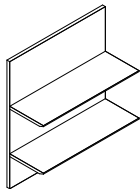

AAW2-3644

FOR USE WITH LOW HEIGHT WORK SURFACE WITH NO OVERHEAD, 68.5" H OVERHEAD, OR SINGLE HEIGHT OVERHEAD MOUNTED AT 84"

MODEL #	DEPTH	WIDTH	HEIGHT	DESCRIPTION	-S	-V
AAW2-2444	13.7	24	44	Double stacked 24"W wood storage shelves	1,280	1,346
AAW2-3044	13.7	30	44	Double stacked 30"W wood storage shelves	1,498	1,578
AAW2-3644	13.7	36	44	Double stacked 36"W wood storage shelves	1,709	1,802



WOOD STORAGE SHELVES AND WALL PANEL

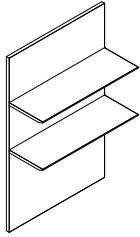

AAW2-3657

SURFACE MATERIAL KEY

- S Painted Wall Panel
- V Veneer Wall Panel

FOR USE WITH STANDARD HEIGHT WORK SURFACE WITH NO OVERHEAD, 84" OVERALL HEIGHT

MODEL #	DEPTH	WIDTH	HEIGHT	DESCRIPTION	-S	-V
AAW2-2457	13.7	24	56.5	Double stacked 24"W wood storage shelves	1,492	1,568
AAW2-3057	13.7	30	56.5	Double stacked 30"W wood storage shelves	1,707	1,800
AAW2-3657	13.7	36	56.5	Double stacked 36"W wood storage shelves	1,917	2,018

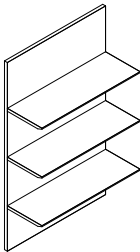

AAW3-3660

FOR USE WITH LOW HEIGHT WORK SURFACE WITH NO OVERHEAD, 84" OVERALL HEIGHT

MODEL #	DEPTH	WIDTH	HEIGHT	DESCRIPTION	-S	-V
AAW3-2460	13.7	24	60	Triple stacked 24"W wood storage shelves	1,551	1,632
AAW3-3060	13.7	30	60	Triple stacked 30"W wood storage shelves	1,770	1,860
AAW3-3660	13.7	36	60	Triple stacked 36"W wood storage shelves	1,980	2,084

GENERAL INFORMATION

- Vertical grain direction
- Veneer species often dictates cut, default veneer cut is flat
- Storage shelf may not be positioned above a height adjustable work surface
- Usable storage shelf depth is 12.7"
- Wire book ends only on Ascari Series metal shelves
- Storage shelves are not available with a tasklight
- The storage shelves are attached to a wall panel that can be finished in either veneer or paint. This wall panel below the bottom shelf will be exposed.

REQUIRED INFORMATION (ORDER CANNOT BE ENTERED WITHOUT THIS INFORMATION)

See appendix pages vi-viii for surface material options.

- Choose Veneer Finish
- Choose Paint Finish, if applicable



WALL-MOUNT OVERHEAD STORAGE

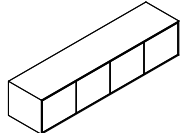

AAROW-F-72S

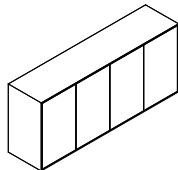

AAROW-F-72D

SURFACE MATERIAL KEY

S	All Paint
V	Veneer
VS	Veneer Case and Painted Front
SG	Painted Case and Glass Front
VG	Veneer Case and Glass Front

FULL-HINGED DOORS // SINGLE HEIGHT

MODEL #	DEPTH	WIDTH	HEIGHT	DESCRIPTION	-S	-V	-VS	-SG	-VG
AAOW-F-36S	17.25	36	15.5	2 Doors	6,873	7,232	7,232	8,108	8,532
AAOW-F-72S	17.25	72	15.5	4 Doors	8,108	8,532	8,532	9,974	10,500
AAOW-F-90S	17.25	90	15.5	5 Door	9,327	9,817	9,817	11,469	12,069
AAOW-F-108S	17.25	108	15.5	6 Doors	10,297	10,843	10,843	12,667	13,311

FULL-HINGED DOORS // DOUBLE HEIGHT

MODEL #	DEPTH	WIDTH	HEIGHT	DESCRIPTION	-S	-V	-VS	-SG	-VG
AAOW-F-36D	17.25	36	31	2 Doors	7,267	7,647	7,647	8,572	9,023
AAOW-F-72D	17.25	72	31	4 Doors	12,540	13,200	13,200	15,424	16,235
AAOW-F-90D	17.25	90	31	5 Door	14,418	15,178	15,178	17,733	18,665
AAOW-F-108D	17.25	108	31	6 Doors	15,926	16,760	16,760	19,583	20,613

OPTIONS

	CODE	PRICE	NOTES
Remove Task Light:	-NTL	Deduct \$407	
Satin Glass Options:			
Single Height Overhead Satin Glass	-SGS	\$594	
Double Height Overhead Satin Glass	-SGD	\$792	

GENERAL INFORMATION

- Vertical grain direction
- Veneer species often dictates cut, default veneer cut is flat
- All overhead storage is wall mount
- Overheads are shipped with mounting hardware for attachment to structural walls
- Customers are responsible for ensuring that the structural wall has adequate strength to support the overhead and it's contents
- Overhead depth is 17.25"; Interior depth is 14.25"
- Task light included on overheads 60 inches and over, but can be removed as an option
- Task lights can dim
- Single height overheads can be mounted at the 84" height
- Double height overheads cannot be mounted above a height adjustable work surface
- Glass overhead doors are tempered
- Back panel options consist of tackable fabric, magnetic glass, and magnetic veneer
- Back panel is recommended to be paired with all wall mount overheads to conceal any hardware and gap between the overhead and architectural wall
- Hinged doors are inset of the case and include a touch latch
- Overall installed height of single height is 68.5"
- Overall installed height of double height is 84"
- Shelves within double high overheads are adjustable

REQUIRED INFORMATION (ORDER CANNOT BE ENTERED WITHOUT THIS INFORMATION)

See appendix pages vi-viii for surface material options.

- Choose Veneer Finish, if applicable
- Choose Metal Finish, if applicable
- Choose Paint Finish, if applicable
- Choose Glass Finishes, if applicable



ASCARI SERIES METAL SHELVES

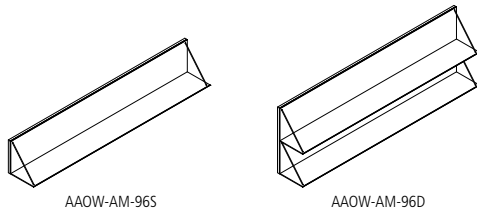

SURFACE MATERIAL KEY

V Veneer

ASCARI SERIES SINGLE METAL SHELF

MODEL #	DEPTH	WIDTH	HEIGHT	DESCRIPTION	-V
AAOW-AM-30S	13.7	30	15.5	Single Metal Shelf with Metal Back Panel and Wire Book Ends	3,756
AAOW-AM-36S	13.7	36	15.5	Single Metal Shelf with Metal Back Panel and Wire Book Ends	4,371
AAOW-AM-42S	13.7	42	15.5	Single Metal Shelf with Metal Back Panel and Wire Book Ends	4,953
AAOW-AM-48S	13.7	48	15.5	Single Metal Shelf with Metal Back Panel and Wire Book Ends	5,501
AAOW-AM-54S	13.7	54	15.5	Single Metal Shelf with Metal Back Panel and Wire Book Ends	6,013
AAOW-AM-60S	13.7	60	15.5	Single Metal Shelf with Metal Back Panel and Wire Book Ends	6,327
AAOW-AM-66S	13.7	66	15.5	Single Metal Shelf with Metal Back Panel and Wire Book Ends	6,634
AAOW-AM-72S	13.7	72	15.5	Single Metal Shelf with Metal Back Panel and Wire Book Ends	6,942
AAOW-AM-78S	13.7	78	15.5	Single Metal Shelf with Metal Back Panel and Wire Book Ends	7,245
AAOW-AM-84S	13.7	84	15.5	Single Metal Shelf with Metal Back Panel and Wire Book Ends	7,554
AAOW-AM-90S	13.7	90	15.5	Single Metal Shelf with Metal Back Panel and Wire Book Ends	7,866
AAOW-AM-96S	13.7	96	15.5	Single Metal Shelf with Metal Back Panel and Wire Book Ends	8,169
AAOW-AM-102S	13.7	102	15.5	Single Metal Shelf with Metal Back Panel and Wire Book Ends	8,478
AAOW-AM-108S	13.7	108	15.5	Single Metal Shelf with Metal Back Panel and Wire Book Ends	8,785
AAOW-AM-114S	13.7	114	15.5	Single Metal Shelf with Metal Back Panel and Wire Book Ends	9,091
AAOW-AM-120S	13.7	120	15.5	Single Metal Shelf with Metal Back Panel and Wire Book Ends	9,402

ASCARI SERIES DOUBLE METAL SHELVES

MODEL #	DEPTH	WIDTH	HEIGHT	DESCRIPTION	-V
AAOW-AM-30D	13.7	30	31	Double Metal Shelf with Metal Back Panel and Wire Book Ends	5,880
AAOW-AM-36D	13.7	36	31	Double Metal Shelf with Metal Back Panel and Wire Book Ends	6,861
AAOW-AM-42D	13.7	42	31	Double Metal Shelf with Metal Back Panel and Wire Book Ends	7,789
AAOW-AM-48D	13.7	48	31	Double Metal Shelf with Metal Back Panel and Wire Book Ends	8,665
AAOW-AM-54D	13.7	54	31	Double Metal Shelf with Metal Back Panel and Wire Book Ends	9,483
AAOW-AM-60D	13.7	60	31	Double Metal Shelf with Metal Back Panel and Wire Book Ends	10,084
AAOW-AM-66D	13.7	66	31	Double Metal Shelf with Metal Back Panel and Wire Book Ends	10,579
AAOW-AM-72D	13.7	72	31	Double Metal Shelf with Metal Back Panel and Wire Book Ends	11,074
AAOW-AM-78D	13.7	78	31	Double Metal Shelf with Metal Back Panel and Wire Book Ends	11,572
AAOW-AM-84D	13.7	84	31	Double Metal Shelf with Metal Back Panel and Wire Book Ends	12,064
AAOW-AM-90D	13.7	90	31	Double Metal Shelf with Metal Back Panel and Wire Book Ends	12,557
AAOW-AM-96D	13.7	96	31	Double Metal Shelf with Metal Back Panel and Wire Book Ends	13,053
AAOW-AM-102D	13.7	102	31	Double Metal Shelf with Metal Back Panel and Wire Book Ends	13,551
AAOW-AM-108D	13.7	108	31	Double Metal Shelf with Metal Back Panel and Wire Book Ends	14,044
AAOW-AM-114D	13.7	114	31	Double Metal Shelf with Metal Back Panel and Wire Book Ends	14,539
AAOW-AM-120D	13.7	120	31	Double Metal Shelf with Metal Back Panel and Wire Book Ends	15,034



ASCARI SERIES METAL SHELVES

OPTIONS	CODE	PRICE	NOTES
Remove Task Light:	-NTL	Deduct \$407	
Polished Chrome Book Ends:	-PCBE	No Charge	

GENERAL INFORMATION

- All shelf storage is wall mount
- Shelves are shipped with mounting hardware for attachment to structural walls
- Customers are responsible for ensuring that the structural wall has adequate strength to support the shelf and its contents
- Usable Shelf depth is 12.7"
- Metal shelves are 1/4" -thick
- Metal shelves and vertical back panel are only available in clear anodized
- Ascari series metal shelves include a vertical metal back panel and 1/4" dia wire book end
- Task light included on shelves 60 inches and over, but can be removed as an option
- Task lights can dim
- Single height shelves can be mounted at the 84" height
- Double height shelves cannot be mounted above a height adjustable work surface
- Angled wire book ends are inset 1" from both the end and front edge of the shelf
- Angled wire book ends require a metal finish selection powder coat or polished chrome
- Overall installed height of single height is 68.5 inches
- Overall installed height of double height is 84 inches

REQUIRED INFORMATION (ORDER CANNOT BE ENTERED WITHOUT THIS INFORMATION)

See appendix pages vi-viii for surface material options.

- Choose Veneer Finish, if applicable
- Choose Metal Finish, if applicable
- Choose Paint Finish, if applicable



METAL SHELVES

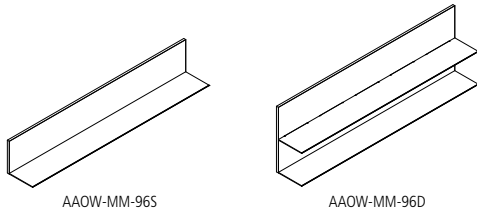

SURFACE MATERIAL KEY

V Veneer

SINGLE METAL SHELF

MODEL #	DEPTH	WIDTH	HEIGHT	DESCRIPTION	-V
AAOW-MM-30S	13.7	30	15.5	Single Metal Shelf	3,481
AAOW-MM-36S	13.7	36	15.5	Single Metal Shelf	4,082
AAOW-MM-42S	13.7	42	15.5	Single Metal Shelf	4,648
AAOW-MM-48S	13.7	48	15.5	Single Metal Shelf	5,182
AAOW-MM-54S	13.7	54	15.5	Single Metal Shelf	5,686
AAOW-MM-60S	13.7	60	15.5	Single Metal Shelf	6,156
AAOW-MM-66S	13.7	66	15.5	Single Metal Shelf	6,465
AAOW-MM-72S	13.7	72	15.5	Single Metal Shelf	6,773
AAOW-MM-78S	13.7	78	15.5	Single Metal Shelf	7,077
AAOW-MM-84S	13.7	84	15.5	Single Metal Shelf	7,388
AAOW-MM-90S	13.7	90	15.5	Single Metal Shelf	7,698
AAOW-MM-96S	13.7	96	15.5	Single Metal Shelf	8,001
AAOW-MM-102S	13.7	102	15.5	Single Metal Shelf	8,308
AAOW-MM-108S	13.7	108	15.5	Single Metal Shelf	8,615
AAOW-MM-114S	13.7	114	15.5	Single Metal Shelf	8,921
AAOW-MM-120S	13.7	120	15.5	Single Metal Shelf	9,231

DOUBLE METAL SHELVES

MODEL #	DEPTH	WIDTH	HEIGHT	DESCRIPTION	-V
AAOW-MM-30D	13.7	30	31	Double Metal Shelves	5,624
AAOW-MM-36D	13.7	36	31	Double Metal Shelves	6,587
AAOW-MM-42D	13.7	42	31	Double Metal Shelves	7,501
AAOW-MM-48D	13.7	48	31	Double Metal Shelves	8,359
AAOW-MM-54D	13.7	54	31	Double Metal Shelves	9,162
AAOW-MM-60D	13.7	60	31	Double Metal Shelves	9,915
AAOW-MM-66D	13.7	66	31	Double Metal Shelves	10,411
AAOW-MM-72D	13.7	72	31	Double Metal Shelves	10,903
AAOW-MM-78D	13.7	78	31	Double Metal Shelves	11,399
AAOW-MM-84D	13.7	84	31	Double Metal Shelves	11,896
AAOW-MM-90D	13.7	90	31	Double Metal Shelves	12,389
AAOW-MM-96D	13.7	96	31	Double Metal Shelves	12,885
AAOW-MM-102D	13.7	102	31	Double Metal Shelves	13,380
AAOW-MM-108D	13.7	108	31	Double Metal Shelves	13,875
AAOW-MM-114D	13.7	114	31	Double Metal Shelves	14,371
AAOW-MM-120D	13.7	120	31	Double Metal Shelves	14,866

OPTIONS	CODE	PRICE	NOTES
Remove Task Light:	-NTL	Deduct \$407	

GENERAL INFORMATION

- Vertical grain direction
- Veneer species often dictates cut, default veneer cut is flat
- All shelf storage is wall mount
- Shelves are shipped with mounting hardware for attachment to structural walls
- Customers are responsible for ensuring that the structural wall has adequate strength to support the shelf and its contents
- Usable shelf depth is 12.7"
- Metal shelves are 1/4"-thick
- Metal shelves are only available in clear anodized
- Task light included on shelves 60 inches and over, but can be removed as an option
- Task lights can dim
- Single height shelves can be mounted at the 84" height
- Double height shelves cannot be mounted above a height adjustable work surface
- Overhead shelves require a back panel below to conceal mounting hardware
- Overall installed height of single height is 68.5 inches
- Overall installed height of double height is 84 inches

REQUIRED INFORMATION (ORDER CANNOT BE ENTERED WITHOUT THIS INFORMATION)

See appendix pages vi-viii for surface material options.

- Choose Veneer Finish, if applicable
- Choose Paint Finish, if applicable



WOOD SHELVES

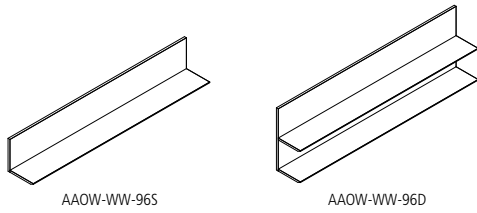

SURFACE MATERIAL KEY

V Veneer

SINGLE WOOD SHELF

MODEL #	DEPTH	WIDTH	HEIGHT	DESCRIPTION	-V
AAOW-WW-30S	13.7	30	15.5	Single Wood Shelf	2,787
AAOW-WW-36S	13.7	36	15.5	Single Wood Shelf	3,266
AAOW-WW-42S	13.7	42	15.5	Single Wood Shelf	3,719
AAOW-WW-48S	13.7	48	15.5	Single Wood Shelf	4,147
AAOW-WW-54S	13.7	54	15.5	Single Wood Shelf	4,552
AAOW-WW-60S	13.7	60	15.5	Single Wood Shelf	4,926
AAOW-WW-66S	13.7	66	15.5	Single Wood Shelf	5,173
AAOW-WW-72S	13.7	72	15.5	Single Wood Shelf	5,417
AAOW-WW-78S	13.7	78	15.5	Single Wood Shelf	5,661
AAOW-WW-84S	13.7	84	15.5	Single Wood Shelf	5,910
AAOW-WW-90S	13.7	90	15.5	Single Wood Shelf	6,156
AAOW-WW-96S	13.7	96	15.5	Single Wood Shelf	6,401
AAOW-WW-102S	13.7	102	15.5	Single Wood Shelf	6,648
AAOW-WW-108S	13.7	108	15.5	Single Wood Shelf	6,894
AAOW-WW-114S	13.7	114	15.5	Single Wood Shelf	7,138
AAOW-WW-120S	13.7	120	15.5	Single Wood Shelf	7,388

DOUBLE WOOD SHELVES

MODEL #	DEPTH	WIDTH	HEIGHT	DESCRIPTION	-V
AAOW-WW-30D	13.7	30	31	Double Wood Shelves	4,499
AAOW-WW-36D	13.7	36	31	Double Wood Shelves	5,273
AAOW-WW-42D	13.7	42	31	Double Wood Shelves	6,002
AAOW-WW-48D	13.7	48	31	Double Wood Shelves	6,688
AAOW-WW-54D	13.7	54	31	Double Wood Shelves	7,332
AAOW-WW-60D	13.7	60	31	Double Wood Shelves	7,931
AAOW-WW-66D	13.7	66	31	Double Wood Shelves	8,329
AAOW-WW-72D	13.7	72	31	Double Wood Shelves	8,723
AAOW-WW-78D	13.7	78	31	Double Wood Shelves	9,120
AAOW-WW-84D	13.7	84	31	Double Wood Shelves	9,516
AAOW-WW-90D	13.7	90	31	Double Wood Shelves	9,913
AAOW-WW-96D	13.7	96	31	Double Wood Shelves	10,308
AAOW-WW-102D	13.7	102	31	Double Wood Shelves	10,704
AAOW-WW-108D	13.7	108	31	Double Wood Shelves	11,101
AAOW-WW-114D	13.7	114	31	Double Wood Shelves	11,498
AAOW-WW-120D	13.7	120	31	Double Wood Shelves	11,893

OPTIONS	CODE	PRICE	NOTES
Remove Task Light:	-NTL	Deduct \$407	

GENERAL INFORMATION

- Vertical grain direction
- Veneer species often dictates cut, default veneer cut is flat
- All shelf storage is wall mount
- Shelves are shipped with mounting hardware for attachment to structural walls
- Customers are responsible for ensuring that the structural wall has adequate strength to support the shelf and its contents
- Usable shelf depth is 12.7"
- Wood shelves are 1" -thick
- Task light included on shelves 60 inches and over, but can be removed as an option
- Task lights can dim
- Single height shelves can be mounted at the 84" height
- Double height shelves cannot be mounted above a height adjustable work surface
- Overhead shelves require a back panel below to conceal mounting hardware
- Overall installed height of single height is 68.5 inches
- Overall installed height of double height is 84 inches

REQUIRED INFORMATION (ORDER CANNOT BE ENTERED WITHOUT THIS INFORMATION)

See appendix pages vi-viii for surface material options.

- Choose Veneer Finish, if applicable
- Choose Paint Finish, if applicable



FREESTANDING STORAGE

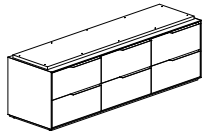

AACC-F-LF-9026

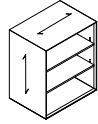

AABC-3017-30

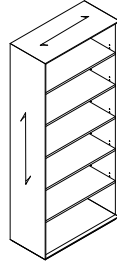

AABC-3617-84

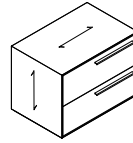

AALF-3626-30

SURFACE MATERIAL KEY

- S All Paint
- V Veneer
- VS Veneer Case and Painted Front

COMMON CASE CREDENZA // 26"-DEEP CREDENZA WORK SURFACE MUST BE SPECIFIED SEPARATELY

MODEL #	DEPTH	WIDTH	HEIGHT	DESCRIPTION	-S	-V	-VS
AACC-F-LF-6026	26	60	29.5	(2) 30"w Lateral Files	7,194	7,572	7,572
AACC-F-LF-7226	26	72	29.5	(2) 36"w Lateral Files	7,572	7,969	7,969
AACC-F-LF-9026	26	90	29.5	(3) 30"w Lateral Files	10,786	11,356	11,356
AACC-F-LF-10826	26	108	29.5	(3) 36"w Lateral Files	11,356	11,952	11,952

BOOKCASE

MODEL #	DEPTH	WIDTH	HEIGHT	DESCRIPTION	-S	-V	-VS
AABC-3017-30	17	30	30	Open Shelf Bookcase with (1) Shelf	3,935	4,143	-
AABC-3017-42	17	30	42	Open Shelf Bookcase with (2) Shelves	4,914	5,175	-
AABC-3017-68	17	30	68.5	Open Shelf Bookcase with (4) Shelves. One shelf fixed at 30"H.	5,625	5,921	-
AABC-3017-84	17	30	84	Open Shelf Bookcase with (5) Shelves. One shelf fixed at 30"H.	6,394	6,732	-
AABC-3617-30	17	36	30	Open Shelf Bookcase with (1) Shelf	4,371	4,601	-
AABC-3617-42	17	36	42	Open Shelf Bookcase with (2) Shelves	5,461	5,749	-
AABC-3617-68	17	36	68.5	Open Shelf Bookcase with (4) Shelves. One shelf fixed at 30"H.	6,249	6,579	-
AABC-3617-84	17	36	84	Open Shelf Bookcase with (5) Shelves. One shelf fixed at 30"H.	7,103	7,477	-

LATERAL FILE

MODEL #	DEPTH	WIDTH	HEIGHT	DESCRIPTION	-S	-V	-VS
AALF-3626-30	26	36	30	2 Drawer Lateral File	4,732	4,981	4,981
AALF-3626-42	26	36	42	3 Drawer Lateral File	5,913	6,227	6,227
AALF-3626-54	26	36	54	4 Drawer Lateral File	7,536	7,782	7,782



FREESTANDING STORAGE

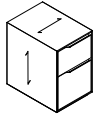

MOBILE PEDESTAL

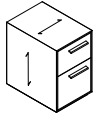

FREESTANDING PEDESTAL

SURFACE MATERIAL KEY

- S All Paint
- V Veneer
- VS Veneer Case and Painted Front

MOBILE PEDESTAL

MODEL #	W x D x H	DESCRIPTION	-S	-V	-VS
AAMP-1822	18 x 22 x 23.5	Mobile Box / File	3,912	3,912	3,912

FREESTANDING PEDESTAL

MODEL #	W x D x H	DESCRIPTION	-S	-V	-VS
AAFP-1522	15.5 x 22 x 23.5	Freestanding Box / File	3,863	3,863	3,863

OPTIONS

OPTIONS	CODE	PRICE	NOTES
No Locks (Pedestals):	-NL	No Charge	

Pull Options:

Integrated Pull (Metal Accent)	-MIP	No Charge	
Integrated Pull (Wood Accent)	-WIP	No Charge	
Metal Tab Pull	-MP	No Charge	
Polished Chrome Pulls	-PCP	\$309	per Pull

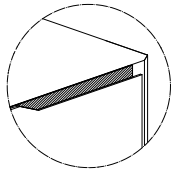

-MIP or -WIP

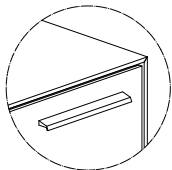

-MP

GENERAL INFORMATION

- Mobile pedestal is on recessed casters
- Freestanding pedestal on glides
- Vertical grain direction
- Veneer species often dictates cut, default veneer cut is flat
- Mitered case construction
- Face locking standard on all storage components
- Storage fronts will be grain-matched set
- All lateral, pedestal and box file drawers are standard with white drawer boxes and undermount soft closing slides
- Door and open shelf storage pedestals include a single adjustable height shelf
- Integrated pull includes a horizontal accent in which a finish must be specified; finish options include veneer, powdercoat, chrome accent, or clear anodized
- Metal Tab Pull finish options include powdercoat, chrome, or clear anodized
- Box drawers include fabric wrapped drawer bottoms. Felt (K1207) or Hopsack (K1206) selection required. If no selection is made, the default choice will be Knoll Felt - Pewter.
- The back of the integrated pull will reflect the wood or metal selection (see shaded area of drawing)
- Common Case Credenza does not include the 2"-thick work surface. Additional 26"-deep credenza work surface must be specified.

REQUIRED INFORMATION (ORDER CANNOT BE ENTERED WITHOUT THIS INFORMATION)

- See appendix pages vi-viii for surface material options.
- Choose Veneer Finish, if applicable
 - Choose Metal Finish, if applicable
 - Choose Paint Finish, if applicable
 - Choose Pull option for Pedestals: Integrated Pull (-MIP or -WIP) or Metal Pull (-MP)
 - Choose Fabric option, if applicable



MEETING TABLES



ROUND



SQUARE

SURFACE MATERIAL KEY

- V Veneer
- G Glass
- S Stone
- SS Solid Surface

ROUND TABLE // COLUMN BASE

MODEL #	DIAMETER	BASE QTY.	TOP SECTIONS	SEATING CAPACITY	-V	-G	-S	-SS
AARO-XC-36	36	1	1	3	4,728	5,909	8,976	6,145
AARO-XC-42	42	1	1	4	5,250	6,565	9,974	6,824
AARO-XC-48	48	1	1	5	6,419	8,024	12,193	8,343

SQUARE TABLE // COLUMN BASE

MODEL #	DIAMETER	BASE QTY.	TOP SECTIONS	SEATING CAPACITY	-V	-G	-S	-SS
AASQ-XC-36	36	1	1	4	4,728	5,909	-	6,145
AASQ-XC-42	42	1	1	4	5,250	6,565	-	6,824
AASQ-XC-48	48	1	1	4	6,419	8,024	-	8,343



ROUND



SQUARE

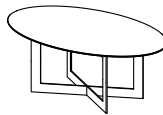

ELLIPSE

ROUND TABLE // OPEN FRAME BASE

MODEL #	DIAMETER	BASE QTY.	TOP SECTIONS	SEATING CAPACITY	-V	-G	-S	-SS
AARO-XF-54	54	1	1	4	8,220	10,276	-	10,686
AARO-XF-60	60	1	1	6	9,863	12,327	-	12,821
AARO-XF-66	66	1	2	6	11,097	13,868	-	14,423
AARO-XF-72	72	1	2	8	12,327	15,411	-	16,024

SQUARE TABLE // OPEN FRAME BASE

MODEL #	DIAMETER	BASE QTY.	TOP SECTIONS	SEATING CAPACITY	-V	-G	-S	-SS
AASQ-XF-54	54	1	1	4	8,220	10,276	-	10,686
AASQ-XF-60	60	1	1	6	9,863	12,327	-	12,821
AASQ-XF-66	66	1	2	8	11,097	13,868	-	14,423
AASQ-XF-72	72	1	2	8	12,327	15,411	-	16,024

ELLIPSE TABLE // OPEN FRAME BASE

MODEL #	D x W	BASE QTY.	TOP SECTIONS	SEATING CAPACITY	-V	-G	-S	-SS
AAOV-XF-3666	36 x 66	1	1	4	9,863	12,327	-	12,821
AAOV-XF-4272	42 x 72	1	1	4	11,097	13,868	-	14,423
AAOV-XF-4878	48 x 78	1	1	4	12,327	15,411	-	16,024



MEETING TABLES

OPTIONS	CODE	PRICE	NOTES
Satin Glass:	-RSG	\$430	
Polished Chrome Base:	-PCB	\$3,387	

EDGE PROFILE



Veneer Edge

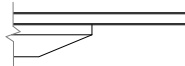

Glass Edge

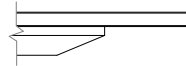

Solid Surface Edge

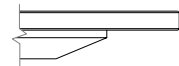

Stone Edge

GENERAL INFORMATION

- Veneer tops are 2"-thick with square edge
- Overall table height is 30"; Stone and Solid Surface tables are 30.5"H
- Base is Steel
- Choose powder coat finish for base
- Glass top is 3/8"-thick and tempered with a 3" overhang from the subtop
- Solid Surface top is 1/2"-thick with a 3" overhang from the subtop
- Stone top is 2cm (.79") thick with a 3" overhang from the subtop

REQUIRED INFORMATION (ORDER CANNOT BE ENTERED WITHOUT THIS INFORMATION)

See appendix pages vi-viii for surface material options.

- Choose Veneer Finish, if applicable
- Choose Metal Finish, if applicable
- Choose Glass Finish, if applicable
- Choose Solid Surface Finish, if applicable
- Choose Stone Finish, if applicable



POWER AND DATA OPTIONS

POWER SPEC	MODEL #	DESCRIPTION	PRICE
 PWR-R-W	PWR-R-B	Round Power Spec with Black Faceplate	128
	PWR-R-W	Round Power Spec with White Faceplate	128
	PWR-SQ-B	Square Power Spec with Black Faceplate	128
	PWR-SQ-W	Square Power Spec with White Faceplate	128



PWR-SQ-W

GENERAL INFORMATION

- Includes one simplex receptable
- 12' cord

REQUIRED INFORMATION: (ORDER CANNOT BE ENTERED WITHOUT THIS INFORMATION)
 See appendix pages vi-viii for surface material options.

- Choose Metal Finish: Satin Nickel (SNB) or Chrome (CB)
- Work surface must be specified with Spec location code to include cutout that accepts Spec unit

USB SPEC	MODEL #	DESCRIPTION	PRICE
 USBC-R-W	USBC-R-B	Round Data Spec with Black Faceplate	267
	USBC-R-W	Round Data Spec with White Faceplate	267
	USBC-SQ-B	Square Data Spec with Black Faceplate	267
	USBC-SQ-W	Square Data Spec with White Faceplate	267



USBC-SQ-W

GENERAL INFORMATION

- Includes one charging USB-A+C
- 12' cord

REQUIRED INFORMATION: (ORDER CANNOT BE ENTERED WITHOUT THIS INFORMATION)
 See appendix pages vi-viii for surface material options.

- Choose Metal Finish: Satin Nickel (SNB) or Chrome (CB)
- Work surface must be specified with Spec location code to include cutout that accepts Spec unit

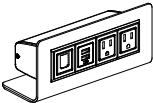
TECH ZONE	MODEL #	DESCRIPTION	SIMPLEX OUTLETS	OPEN DATA PORTS	CHARGING USB-A+C	BLUETOOTH SPEAKER	PRICE
 ZONE-USB-C	ZONE-DATA	(2) Simplex receptacles, (2) Open data ports	2	2	-	-	375
	ZONE-USB-C	(2) Simplex receptacles, (1) Charging USB-A+C, (1) Open data port	2	1	1	-	449

ZONE-USB-C



ZONE-DATA



ZONE-USB-C

GENERAL INFORMATION

- 72" long plug-in infeed cord
- Finish is black
- Includes a Voice/Data Adapter Kit to accept couplers and jacks when required



ACCESSORIES

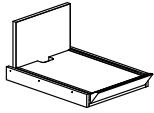

EQUIPMENT SHELF

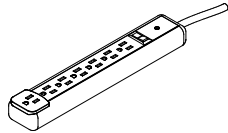

PLUG STRIP

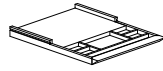

PENCIL DRAWER

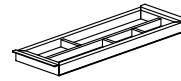

PENCIL TRAY

EQUIPMENT SHELF

MODEL #	W x D x H	DESCRIPTION	PRICE
AAEQ-18	16.28 x 23.5 x 11.69	Equipment Shelf - 18" wide	683
AAEQ-24	22.28 x 23.5 x 11.69	Equipment Shelf - 24" wide	705

GENERAL INFORMATION

- Only compatible with door pedestals
- Solid wood front and side rail
- Bottom and back panel veneered to match case
- A field cut wire pass through is required on the pedestal where it will be used

PLUG STRIP

MODEL #	W x D x H	DESCRIPTION	PRICE
MOA-10	2.05 x 11.69 x 1.32	Black Power Plug Strip	201

GENERAL INFORMATION

- 15 amps - Mounts into Wire Trough
- Includes (7) outlets, surge protection and 12' electrical cord

PENCIL DRAWER

MODEL #	W x D x H	DESCRIPTION	PRICE
AA-CD	22-3/16 x 23-5/8 x 2	Organizer Drawer	1,863

GENERAL INFORMATION

- Pencil Drawer only available on Static Free Standing Desks
- Solid wood frame and front rail
- Solid wood core, veneered to match case
- Pencil drawer bottoms include Felt and Hopsack drawer liner. (Selection required)
- Drawer dividers are aluminum polished chrome. (Dividers are adjustable)

PENCIL TRAY

MODEL #	W x D x H	DESCRIPTION	PRICE
AAPT-18	13 x 4.25 x 1	Pencil Tray for Box Drawer	280

GENERAL INFORMATION

- Solid wood frame, painted white to match pedestal drawer.
- Pencil drawer bottoms include Felt and Hopsack drawer liner. (Selection required)
- Drawer dividers are aluminum polished chrome. (Dividers are adjustable).

PENCIL STOP

MODEL #	DESCRIPTION	PRICE
APS-XX	Pencil Stop	172
APX-XX-PC	Polished Pencil Stop	268

GENERAL INFORMATION

- Pencil Stop runs along the length of the work surface. Final part number should be the actual length of Pencil Stop needed. Example: APS-36



Appendix



GENERAL INFORMATION

This price book supercedes all previous versions.

Before placing your order, confirm you have all required information necessary. Lead times for orders begin after all required information is included and correct.

Delivery Information

We know lead times are important and sticking to them even more so. We work to maintain a 6-8 week lead time on all standard products in this book from receipt of a clean order. All orders are acknowledged with an approximate shipping date and will be invoiced with the price in effect at the date the purchase order is received. For current lead times, please review www.nucraft.com/resources/lead-times.

Shipping charges are prepaid (within the continental U.S.). Therefore, pricing is a delivered price based on normal ground transportation. If you have special instructions, need to ship by air, or are shipping to Alaska or Hawaii, contact NuCraft Customer Service. NuCraft can also help arrange to have products blanket wrapped for an additional charge. Contact the NuCraft Customer Service team or specify it on your purchase order.

Minimum Freight Charge: Any order below \$3,000 net will be assessed a \$500 net minimum freight charge (one per order).

Orders are subject to acquiring the materials required for manufacturing. Fulfillment can be affected by strikes, fires, embargoes and acts of government. These elements are beyond our control.

NuCraft offers a variety of services to accommodate a wide range of delivery requirements. Availability of these services is dependent on a number of factors and may not be offered with all shipments. Examples of delivery services that have additional fees include:

- Specific date
- Specific time of day, morning or afternoon
- Delivery to a warehouse before delivery to its final destination (unless product is picked up at the warehouse)

Contact the NuCraft Customer Service team for availability and pricing on these services.

Freight Terms

Shipping charges for NuCraft products are prepaid for standard delivery in the continental United States. Standard delivery is defined as follows: Product is delivered on a 53' trailer being pulled by a long-haul tractor (total length of 85'). Facility will receive delivery Monday through Friday between the hours of 8:00 AM and 4:00 PM. Facility has docks with levelers and a fork truck for unloading. Product will be loaded on load bars two levels high. Receiving facility is responsible to have personnel on hand to unload the truck upon arrival, drivers do not unload. Delivery sites or times that do not meet these criteria may be accommodated, but will incur a charge to cover additional shipping costs. Please **notify NuCraft a minimum of two weeks prior to shipment** to arrange special services and determine additional charges.

Storage

NuCraft has no storage facilities for finished product. If a customer cannot accept an order when it is ready for shipment, the customer must designate an alternative shipping address. If no address is provided, NuCraft may, at its discretion, transfer the product to storage. If product is transferred to an off-site storage facility, the customer may be charged for transportation to the facility and for any associated storage fees. NuCraft considers transfer of the product to a storage facility the equivalent of shipment, including invoicing and payment. Customers assume the risk of damage or loss during storage.

Transportation Times and Delays

Third party carriers that NuCraft contracts with will make reasonable efforts to accommodate requested delivery times and dates. Scheduled delivery appointments may, however, be delayed for a variety of reasons, including inclement weather, traffic, transportation equipment problems, and delays encountered at other delivery locations along the delivery route. NuCraft does not recommend scheduling activities that depend on the delivery appointment (for example, scheduling furniture installers to install furniture the day of the delivery appointment). NuCraft shall not be liable for any costs incurred as a result of a missed delivery appointment.

Shipment Damage Claims

Legal title to merchandise passes to the buyer upon acceptance by the carrier. Inspect all cartons upon delivery. Details of visible damage should be noted on the delivery receipt. Do not destroy packaging, transport to site, or install product if damage is found upon inspection. Inspection of products should be completed upon delivery to the receiver. If visible damage is apparent, a claim should be filed immediately with NuCraft Customer Service. If visible damage is not apparent, sign the delivery receipt "No visible damage." This will allow recourse for a concealed damage claim. Concealed damage claims must be filed within 15 days of receipt, **prior to transporting or installing any product.**

Do not destroy packing materials until shipment has been inspected. If damage is found, proceed to file a claim with NuCraft Customer Service.

Failure to make any claims against NuCraft within 15 days shall constitute acceptance of the merchandise and a waiver of any defects, errors or shortages discovered upon inspection.

Cancellations

Cancellations must be reviewed by our Customer Service team. Because we build your products to order, orders cannot be cancelled once processing has begun. Processing includes but is not limited to development of shop drawings and other engineering drawings. If cancellation is approved, a processing fee of 20-100% will be assessed based on the status of the order.

Change Order Policy

NuCraft will make every attempt to honor any reasonable change request to product provided that the request is received prior to start of production. Change orders will be accepted only if the request is made in writing and received in time to make the change. NuCraft reserves the right to increase our acknowledged price and ship date if necessary to make the requested changes. Please submit any change order request to our Customer Service team. NuCraft will assess charges to the customer as stipulated in the following:

- Standard Orders: Change orders received prior to production will be charged \$400 net to cover administrative costs.
- Special Orders: Change orders received prior to production will be charged \$400 net to cover administrative costs. There may be additional costs associated with engineering labor required for the change order.
- Change orders received after production must be evaluated by NuCraft. If approved, the charge will be \$400 net plus any restocking charges accumulated. There may be additional costs associated with engineering and/or manufacturing labor, as well as material costs, required for the change order.



GENERAL INFORMATION

Repair Authorization

Prior written approval is required for repairs of merchandise charged to Nucraft. Failure to do so will result in customer funded repairs.

Payment Terms

Deposits are required at the time of order due to the custom nature of our products. See information regarding Cancellations above.

Credit terms are available to qualified customers. Please contact AR@Nucraft.com to start the application process. Note that the credit application process requires a valid sales tax exemption or resale tax certificate, Form W-9, and three current trade references.

Credit Card Payments are accepted via web portal. Please contact AR@Nucraft.com for payment instructions. Note that a 2% convenience fee will be added for using this payment method and no early pay discounts are allowed on credit card payments.

Warranty

Nucraft Furniture is warranted to be free from defects in materials and workmanship for a period of ten years of single shift use. Limitations include:

- Mechanical Devices such as latches, casters, and other moving components are warranted for five years of the date of original delivery.
- Height adjustable components are warranted for two years of the date of original delivery.
- The following are warranted for one year of the date of original delivery:
 - Textiles
 - Electrical Components
 - Refrigeration Units
 - Custom Products not described in Nucraft's Catalogue

This warranty is applicable only if furniture is properly installed and maintained in an office environment. This warranty extends only to products manufactured and sold in North America and only to original purchasers acquiring new Nucraft product through authorized dealers or approved sellers.

During this warranty period, Nucraft's sole obligation is to repair or replace, at Nucraft's discretion, products which prove to be defective during the warranty period.

This warranty does not cover:

- Damage caused by a carrier.
- Damage from user modification, misuse, abuse, accident, or negligence.
- Customer's Own Material (COM) specified by the customer that is not a standard product offering.
- Color, grain, or texture of wood and other covering material.

Nucraft extends no other warranties, expressed or implied, including warranty of merchantability or fitness for a particular purpose. Nucraft shall not be liable for loss of time, inconvenience, commercial loss, incidental or consequential damages.

Environmental Statement

Nucraft is committed to supporting responsible environmental policies and practices in all that we do. We strive for sustainability, weighing our business decisions against the costs to the ecological, social and economic systems they affect.

Our products are manufactured to meet the credit requirements of the U.S. Green Building Council's LEED rating systems in one or more of the following categories:

- Recycled Content
- Certified Wood
- Low-Emitting Materials

Computer Aided Planning

Nucraft products and pricing are available via CET and 2020 Worksheet, an AutoCAD®-based space planning tool.

2020 Worksheet is an integrated software system developed specifically for interior designers and facility planners to enhance workplace performance. This modern suite of applications works together seamlessly, in concert. Navigate catalogs, select products, design in plan view and 3D, assign options, create worksheets and build a project where you want, when you want. Take your pick. It's dynamic and interactive. Design projects are a work in progress. And now you can perform any of the many discrete tasks that go into a project any time, any place.

Product symbols (Revit, 2D and 3D) are available on the Nucraft website at www.nucraft.com/resources/designer-tools/product-symbols.

iSpec®

Nucraft offers a free online product configuration and specification service that saves you time and allows you to be creative while leaving the nuts and bolts to someone else. No specific software is required, nor is there any learning curve. This service applies to all Nucraft products. For additional information, visit www.nucraft.com/resources/designer-tools/ispec.



FINISH INFORMATION

Surface Materials Palette

We crafted our materials palette using the same demanding standards that distinguish our furniture. Thoughtful design and attention to every detail elevate your possibilities.

Anchored by Nucraft veneers, unrivaled for clarity, quality, and depth of finish, our collection of surface materials comprises a sophisticated set of balanced elements that supports your design vision.

Some elements have their roots in Nucraft's rich heritage. Others are new materials and reflect current trends and taste. Together, they ensure that you're ready for today and positioned well for the future. Beautifully.

Custom Finishes

Nucraft specializes in expert custom finish matching. For a nominal upcharge we can provide custom finishes, and we are frequently asked to match the finishes of other furniture manufacturers. For finishes that appear unusual to match or for customers directly requesting a sample, a finish sample will be sent for approval prior to entering the order.

Custom finishes requiring colored varnishes to create a painted look can only be applied to Maple veneer and require one extra week in addition to the standard lead time. Nucraft's standard black finish (G82) can be applied to all Nucraft standard veneers. Walnut is the standard black veneer. Other species must be specified when ordering.

Clear coat on a special veneer requires an approved sample.

Custom finishes carry a 10% upcharge per item, per finish, capped at \$2,200 List.

Custom finish upcharges are not applied to any item that is not wood. Example: casters, ganging connectors, power options..

Treatments

Note: Default veneer sheen will vary per finish and product. Default finish is bolded on pages vi-vii. If no direction is provided on incoming orders, default sheen will be selected. In addition, default veneer cut is noted in the price list. If no direction is provided on incoming orders, default cut will be selected.

Gloss: Gloss is a durable finish that tends to nicely mask normal wear and leaves wood grain visible to the eye. It achieves a medium gloss open pore appearance (40 – 50 sheen range). Finish numbers preceded by the letter "G" indicate a Gloss finish.

Matte: Like Gloss, Matte is durable, tends to nicely mask normal wear and leaves wood grain visible to the eye. It achieves a low luster, open pore appearance (10 – 20 sheen range). Finish numbers preceded by the letter "M" indicate a Matte finish.

Since each veneer type responds differently to both types of treatment, all will have a distinctive look and feel when finished. For example, a Walnut veneer with a Gloss treatment will remain much more textured than a Cherry veneer with the same treatment.

About the Wood

All Nucraft veneers are carefully selected for uniformity of color and grain. Still, wood is a natural substance and minor variations may occur due to its own uniqueness. Because of this, the furniture you receive may not be an exact match to our samples.

Nucraft takes great pride in our finish color consistency. However, wood is a natural product that will have color variation within a single piece of furniture, as well as from one piece to the next. Other factors also affect color over time, such as exposure to light (both intensity and duration). For example, lighter finishes cause more variation in colors over time.

In cases where a returning customer wants a precise match with existing furniture, we recommend sending a sample of the existing furniture finish. Please contact Nucraft Customer Service to determine an appropriate sample. This will ensure a finish match between old and new orders. This type of order is considered a control sample. There will be a 10% upcharge on an order of this type. Due to natural aging of veneers, natural finishes may vary.

Care and Maintenance of Wood Finishes

Our finish material is a crystal clear, urethane acrylic blend. This type of finish may be repaired in the field by a qualified refinisher.

Nucraft recommends using a damp cloth to clean your fine wood furniture. Always wipe with the grain of the wood. Should your wood furniture require a more thorough cleaning, we recommend using a mild cleaner such as Joy dish soap or Murphy's oil soap, thoroughly diluted in water (one part soap to thirty parts water). Water will not damage Nucraft's finish, but it may leave surface spots when it dries. To avoid this, dry the surface with a soft cloth after it is cleaned. Marks that cannot be removed with the cleaning methods above may be able to be removed using naphtha, a mild degreasing solvent.

Caution: while the use of polishes that contain wax, petroleum solvents or silicones may immediately enhance the "shine" of a product, it may also eventually remove the fine original finish applied in our factory. Silicone on the surface of wood may also make it very difficult to respray or refinish.

All Nucraft furniture is inspected and polished before it leaves our factory. In some instances, the packing materials may imprint on the factory polish. Cleaning and polishing the furniture once it is unpacked will normally restore the furniture to its original beauty.

In some cases, the rubber support feet used on the bottom of common office equipment (teleconferencing phones, laptops, microphones, copiers, etc.) can create unsightly marks in the surface of wood tops, due to oxidation of the lacquer finish. We suggest these machines be placed on a protective type of padding, such as felt.

Wood will fade as a result of exposure to UV light. This is particularly prevalent with light finishes. If color changes due to fading are a concern for your application, the impact can be minimized by selecting medium to dark stains for your wood surfaces. Our top coat includes a UV inhibitor which makes the finishes less prone to fading.



FINISH INFORMATION

Laminates

Selected Formica®, Nevamar®, and Wilsonart® laminates are available on Training Tables, Conference Tables, Conference Room Furniture and select Occasional Tables. For standard laminate and wood pricing, refer to individual item pricing columns. It is important to note that wood grain laminates are unable to be grain matched over multi-piece table top applications.

Non-Standard Laminates and Linoleums

To order a color other than those on our list (see pages vi-vii), refer to Nevamar or Formica standard grade, matte texture laminate offerings and Forbo Furniture Linoleums (excluding manufacturers' non-standard matte offering).

Nucraft can support other laminate and linoleum options beyond what can be found as standard options on pages vi-viii. For pricing, please send a request to quotes@nucraft.com.

Care and Maintenance of Laminate and Novawrap

Laminate and Novawrap surfaces may be cleaned with a damp cloth and ordinary soap or non-abrasive household liquid detergent. Dry the surface with a clean cloth or soft paper towel to prevent streaks from appearing.

Care and Maintenance of Metal

Metal surfaces can be wiped with a damp cloth and rubbed dry. A mild non-abrasive household liquid detergent can be used if necessary. Regular maintenance of metal components, including tightening of fasteners and light lubrication of moving parts, will extend the life of your furniture.

Satin Etched Glass

Glass color may vary slightly on multi-piece conference table tops over 180" x 60" when satin etched glass is specified due to the iron content and etching process of the glass.

Care and Maintenance of Glass

Clear or frosted glass may be cleaned with commercial glass cleaner. Be sure to use a lint-free cloth if cleaning the frosted side of the glass.

Stone and Solid Surface Material

Despite its reputation for durability, natural stone can easily be broken during handling and/or installation if proper techniques are not followed. In addition, Nucraft is not responsible for the installation of natural stone or solid surface materials on its products. Therefore, installers specifically trained in the installation of these materials must be utilized to ensure a quality installation. Nucraft shall not be liable for any damages incurred during the handling and/or installation of natural stone or solid surface materials on its products.

Care and Maintenance of Granite

Granite surfaces may be cleaned with a damp cloth and ordinary soap or non-abrasive household liquid detergent. Dry the surface with a clean cloth or soft paper towel to prevent streaks from appearing.

Care and Maintenance of Leather

Genuine leather requires very little care. Nucraft recommends that leather be dusted regularly. If a more thorough cleaning is needed, use lukewarm water and a mild, non-abrasive soap. Generate some lather and lightly rub the surface with cheesecloth. Rinse off any soap film with clean water and towel dry. The leather may dry dull. To restore the leather to a normal gloss, rub it with a clean towel. Never use furniture polish, oil, varnish or ammonia. Saddle soap may be used to prevent the leather from becoming brittle or cracked and to maintain the original supple finish.

Touch Up Finish Kits

Model #	Description	Price
KIT-M	Metal Kit	85
KIT-P	Paint Kit	85
KIT-S	Stain Kit	85

REQUIRED INFORMATION: (ORDER CANNOT BE ENTERED WITHOUT THIS INFORMATION)

- Kit model number
- Quantity of kits
- Specify finish (See pages vi-vii)

General Information:

- Touch-up kits must be ordered on a purchase order separate from Nucraft product due to Hazmat shipping

Retrofit & Replacements

If needing a partial placement or retrofit solution, please reach out to our quote team. Grain/color matched in a set.



VENEER

STANDARD

Default veneer sheen will vary per finish and were determined by a team of experts who reviewed the colorways to determine if gloss or matte best highlighted the natural characteristics of the species of wood and the color of the stain. Default finish is bolded. If no direction is provided, default sheen will be selected.

	Matte	Gloss
Rift Cut Oak		
Carbon	M03	G03
Flat Cut Oak		
Artisan	M68	G68
Coco	M67	G67
Dove	M66	G66
Dune	M05	G05
Midnight	M69	G69
Portobello	M7413	G7413
Winter	M70	G70
Flaky Oak		
Sahara	M61	G61
Cherry		
Auburn	M93	G93
Cognac	M21	G21
Walnut		
Marron	M35	G35
Mocha	M33	G33
Onyx	M82	G82
Otter	M31	G31
Zinc	M30	G30
Maple		
Natural Maple	M60	G60
Linea		
Euro Birch Linea	M09	G09
Oak Linea	M08	G08
Silver Birch Linea	M10	G10
Walnut Linea	M27	G27
Paldo		
Canyon	M77	G77
Paldo	M76	G76
Thicket	M75	G75

GLASS

Satin or Gloss Glass	Satin	Gloss
Black	BS	-
Clove	VS	VG
Meringue	MS	MG
Moonlight	MLS	MLG
Storm	STS	STG
Quill	QS	QG
White	WS	WG



ASCARI™ CASEGOOD SURFACE MATERIALS

STONE

Stone orders may affect lead times. Standard Cambria finish is polished. For alternative finish options, please contact Nucraft Customer Service.

Stone	Subtop Paint	
Absolute Black Honed Granite	ST01	S8007
Carrara Marble	ST16	S8004

Quartz | Cambria® Signature

Ainsley	STC100	S8004
Armitage	STC101	S44
Avalene	STC192	S8004
Bellingham	STC102	S8004
Berkeley	STC103	S8004
Berwyn	STC104	S8004
Blackbrook	STC105	S44
Bradshaw	STC106	S8004
Bradwell	STC107	S8004
Cambria Black	STC109	S44
Carrick	STC110	S44
Charlestown	STC207	S44
Charston	STC208	S44
Clifton	STC112	S8004
Colton	STC113	S8004
Copeland	STC200	S8004
Crowndale	STC114	S8004
Devon	STC115	S44
Dovestone	STC209	S8004
Fairbourne	STC116	S8004
Fieldstone	STC117	S44
Hadley	STC201	S44
Halewood	STC119	S8004
Hermitage	STC120	S8004
Kendal	STC122	S8004
Laneshaw	STC124	S44
MacBeth	STC202	S8004
Malvern	STC125	S8004
Montgomery	STC128	S8004
New Quay	STC130	S8004
Pendle Hill	STC131	S8004
Praa Sands	STC132	S8004
Ridgegate	STC203	S8004
Rose Bay	STC133	S8004
Sandgate	STC135	S8004
Seacourt	STC204	S8004
Smithfield	STC136	S8004
Sutherland	STC138	S8004
Swanbridge	STC139	S8004
Torquay	STC140	S8004
Trafalgar	STC205	S8004
Travella	STC141	S8004
Weybourne	STC143	S8004
Whitendale	STC206	S8004
Whitney	STC144	S8004
Woodcroft	STC146	S44

Quartz | Cambria® Luxury

Abbey	STC147	S8004
Annicca	STC148	S8004
Beckington	STC150	S8004
Bentley	STC151	S8004
Brighton	STC212	S8004
Brittanicca	STC153	S8004
Brittanicca Gold Cool	STC154	S8004
Brittanicca Gold Warm	STC155	S8004
Brittanicca Warm	STC156	S8004
Claremont	STC215	S8004
Clovelly	STC158	S8004
Delamere	STC159	S44
Delgatie	STC160	S8004
Ella	STC161	S8004
Everleigh	STC162	S8004
Everleigh Warm	STC191	S8004
Gladstone	STC163	S8004
Golden Dragon	STC164	S44
Hailey	STC165	S8004
Harlow	STC166	S8004
Hemsworth	STC167	S8004
Huntley	STC168	S8004
Inverness Blakeley	STC190	S8004
Inverness Bristol Bay	STC169	S8004
Inverness Bronze	STC170	S8004
Inverness Cobalt	STC171	S8004
Inverness Everleigh	STC172	S8004
Inverness Frost	STC196	S8004
Inverness Gold	STC197	S8004
Inverness Platinum	STC173	S8004
Inverness Swansea	STC174	S8004
Ironsbridge	STC175	S8004
Iverness Frost	STC176	S8004
Iverness Gold	STC177	S8004
Kenwood	STC216	S8004
Lakedale	STC179	S8004
Mayfair	STC181	S8004
Mersey	STC182	S44
Notting Hill	STC183	S8004
Oakleigh	STC184	S8004
Portrush	STC185	S8004
Queen Anne	STC186	S8006
Skara Brae	STC187	S8004
Southport	STC188	S8004
White Cliff	STC189	S8004



ASCARI™ CASEGOOD SURFACE MATERIALS

Quartz | Cambria® Coordinates

Big Sur Mist	STC221	S8004
Black Rock	STC223	S44
Foggy City	STC220	S8004
Mammoth Cave	STC222	S44
Minnesota Snow	STC219	S8004
Salt Lake	STC218	S8004
St. Isley	STC213	S8004
Traymore Bay	STC214	S8004

Quartz | Wilsonart

Carrara Codena	ST21	S8004
Serene	ST17	S8004

SOLID SURFACE

Wilsonart Designer White	ST11
--------------------------	------

METAL

Powder Coat

Aged Bronze	A8010
Black	A44
Burnished	A8009
Cloud	A8004
Foil	A8006
Galaxy	A8007
Moonlight	A87
Satin Bronze	A8011
Shadow	A8005
Storm	A8012

Metal

Clear Anodized	CA
----------------	----

PAINT

Aged Bronze	S8010
Black	S44
Burnished	S88
Cloud	S8004
Foil	S8006
Galaxy	S8007
Moonlight	S87
Satin Bronze	S8011
Shadow	S8005
Storm	S8012

Paint to Match

To request a custom paint color, contact Nucraft Customer Service. A paint sample must be matched and approved prior to order.



UPHOLSTERY FABRIC

Applies to Pedestal Cushions.

Nucraft is pleased to partner with KnollTextiles, Kvadrat, Spinneybeck, and UltraFabrics to offer a concise selection of standard upholstery fabrics pre-approved for use on our products, with prices that are figured into our graded-in system. We've carefully curated a selection of each of the textile's color lines to coordinate with our materials offering. However, all colorways are approved and available as standard. Please contact fabric manufacturer for sampling support.

UltraFabrics Brisa Original | 533 | Grade C

Abyss	9378
Apple Green	4448
Ash	5802
Aztec	3823
Bark	3914
Beet Root	1361
Birch	3019
Black Onyx	5749
Blue Sea	2621
Bone	3822
Cabernet	9400
Cambridge Blue	2645
Canyon	3825
Caramel	3591
Celery	4510
Cinnabar	8245
Clear Quartz	6528
Coffee Bean	3023
Cream	3863
Desert Clay	3864
Esmeralda	4302
Evening Blue	2620
Ginger	3051
Harbor Mist	2793
Hazy	5360
Honeydew	4345
Ice Pink	6596
Iceberg	3272
Indigo	2683
Koi	8202
Lambs Ear	4361
Mineral	2697
Moon	3277
Mystic Beige	3775
New Sand	3946
Night Navy	2694
Olive	4488
Peat	3200
Pompeian Red	1383
Putty	3915
Quicksilver	5820

Rising Tide	2794
Rose Red	1344
Sage	4487
Salsa	1373
Seaweed	4303
Shiitake	3022
Skyway	2696
Sterling Blue	2698
Truffle	3913
White	5747
Wishbone	3276
Wrought Iron	5703
Yukon Gold	8269

Knoll Hopsack* | K1206 | Grade C

Admiral	11
Black	16
Buff	1
Lime	4
Magenta	9
Putty	13
Red	10
Stucco	2

Knoll Felt* | K1207 | Grade D

Apple	3
Cadet	11
Canary	5
Ivory	1
Mocha	15
Pewter	17
Poppy	7
Tar	20

*In addition to being available on all of our Pedestal cushion applications, these upholstery fabrics are approved for tackzone application and drawer bottoms on Nucraft products.



LEATHER

Spinneybeck Vincenza | VZ | Grade E

Appia Antica	2120
Black	BLCK
Castello di Bellaguardia	2112
Cinque Terre	2122
Costozza	2116
Peralolo	2115
Ponte Furo	2102
Nocciola	2117
Salvi	2101
Scamozzi	2114
Villabalzana	2108

Spinneybeck Volo | VO | Grade F

Black	BLCK
Casablanca	975
Dromedary	977
Lichen	902
Mauve Beige	954
Oatmeal	957
Parchment	960
Petroglyph	962
Rust	905
Talc	939
Tuscany	963

GRADED-IN FABRIC PROGRAM

Top quality upholstery and fabrics have been graded into the price lists. We work with various distributors and now offer a larger selection of fabrics. For fabric grades and availability, check our website at www.nucraft.com.

NET PRICE PER YARD	NUCRAFT GRADE
\$0 - \$30.00	A
\$30.01 - \$45.00	B
\$45.01 - \$60.00	C
\$60.01 - \$75.00	D
\$75.01 - \$90.00	E
\$90.01 - \$105.00	F
\$105.01 - \$120.00	G
\$120.01 - \$135.00	H

\$135.00 and above: Contact Nucraft Customer Service



TACKZONE FABRIC

Nucraft is pleased to have partnered with KnollTextiles to offer a concise selection of standard fabrics pre-approved for use on our products, with prices that are figured into our graded-in system. We've carefully curated a selection of each of the textile's color lines to coordinate with our materials offering. However, all colorways are approved and available as standard. Please contact fabric manufacturer for sampling support.

All tackzone fabrics are applied railroaded.

KnollTextiles Beacon | W1597 | Grade A

Bonfire	7
Cool Gray	11
Dust	12
Fossil	3
Hotshot	6
Marsh	4
Nile	9
potlight	1
Putty	10
Reef	8
Saffron	5
Tusk	2

KnollTextiles Reflect | W884 | Grade B

Ecru	5A
Ember	9A
Ice	1A
Lagoon	14A
Sharkskin	13A
Sterling*	3A
Target	10A
Titanium	2A

*Default Fabric

GRADED-IN FABRIC PROGRAM

Top quality upholstery and fabrics have been graded into the price lists. We work with various distributors and now offer a larger selection of fabrics. For fabric grades and availability, check our website at www.nucraft.com.

NET PRICE PER YARD	NUCRAFT GRADE
\$0 - \$30.00	A
\$30.01 - \$45.00	B
\$45.01 - \$60.00	C
\$60.01 - \$75.00	D
\$75.01 - \$90.00	E
\$90.01 - \$105.00	F
\$105.01 - \$120.00	G
\$120.01 - \$135.00	H

\$135.00 and above: Contact NuCraft Customer Service



COM SPECIFICATION

For COM orders please include the following:

- Name of customer
- Customer's purchase order number
- Model number and quantity of piece(s) to be covered
- Specify right-way or railroad application (railroad is the default if no selection is made)
- If fabric is a stripe or pattern, specify vertical or horizontal application
- Supplier's name, material number and description

YARDAGE ESTIMATING

All yardages in the price list are based on 54" wide plain (no match) fabric. The following is a guide for fabrics that are less than 54" wide or have a pattern match.

Fabric Less Than 54" Wide

For 50" wide fabrics allow 10% additional fabric
 For 48" wide fabrics allow 15% additional fabric
 For 45" wide fabrics allow 20% additional fabric
 For 36" wide fabrics allow 50% additional fabric

For Pattern Match Fabrics

3" to 14" repeat allow 15% additional fabric
 15" to 19" repeat allow 20% additional fabric
 20" to 27" repeat allow 25% additional fabric
 28" to 36" repeat allow 30% additional fabric

Nucraft may add a charge for sewing, cutting and matching unusual COM or COL materials to cover additional costs. Call customer service for pricing.

It is the sole responsibility of the customer to determine that the fabric is appropriate for the application in which it will be used.

Once COM/COL is accepted, Nucraft assumes no responsibility for its overall appearance, flammability, normal durability, color fastness or any other quality after upholstered on a Nucraft product beyond our normal quality standards.

FIRE RESISTANCE

Nucraft will only work with textiles that meet the ACT Voluntary Performance Guidelines:

- Nucraft fabric tack panels incorporate fabrics that meet the ASTM E 84 standard US flammability test for wrapped panels.
- Nucraft upholstery fabrics for benches and cushions must meet one or more of the following flammability tests; NFPA 260, NFPA 701, or CAL 117.
- All COM fabrics must meet the required flammability standards per fabric application.
- Nucraft reserves the right to decline any fabrics that do not meet ACT standard flammability requirements.

COM LEATHER SPECIFICS

The following is a guide for specifying leather requirements. The guide is based on the following general information.

A full "domestic" hide is approximately 50-60 square feet. A specialty or calf hide is approximately 35 square feet. Of this footage there are various non-usable areas included in the hide's size. Conversion of fabric yardage to leather is approximately 1 yard = 18 square feet.

Bench Requirements

48" benches will require 1/2 domestic hide or 1 full calf hide.

60" benches will require 1 domestic hide or 2 calf hides.

72" benches will require approximately 1 full domestic hide or 3 calf hides.

The boxing around the seat, if required, will have 4-6 seams that will be placed aesthetically based on the yield and usable remains of the hides.