

ASCARI™ CONFERENCE

Planning Guide + Price List

QUICK LINKS

[PLANNING GUIDE](#)

[ASCARI CONFERENCE
PRICING](#)

[POWER AND DATA OPTIONS](#)

[GENERAL INFORMATION](#)

[FINISH INFORMATION](#)

[SURFACE MATERIALS](#)



TABLE OF CONTENTS

Click the shortcuts below to jump to each section.

General Information	ii-iii
Finish Information	iv-v
Surface Materials	vi-viii
Statement of Line	3
Specification Overview	4
Planning Guide	5-38
- Detail Overview	5-9
- Table Top Power	10-25
- Under Surface Power	26-28
- Wire Management	29-33
- Base Details	34-38
Ascari Round Tables	39-45
Ascari Rectangle Tables	46-65
Ascari Boat Tables	66-73
Power and Data Options	74-82





STATEMENT OF LINE

ASCARI CONFERENCE TOP SHAPES

Pages 39-73



Round

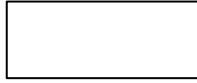

Rectangle



Boat

ASCARI CONFERENCE BASES

Pages 39-73

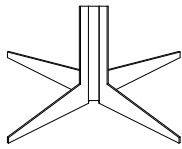

Column Base

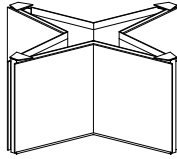

Closed Panel X Base

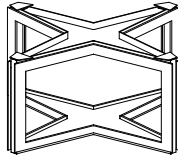

Open Panel X Base

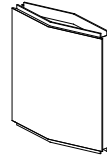

Closed Panel Base

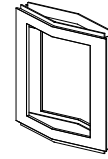

Open Panel Base

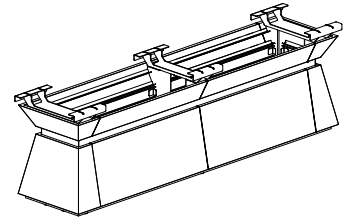

Island Base

ASCARI EDGE PROFILES

Pages 39-73



2" Thick

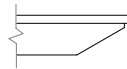

Square

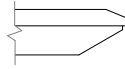

Chamfer

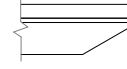

Square with Metal Detail Option

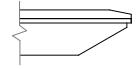

Chamfer with Metal Detail Option



SPECIFICATION OVERVIEW

ASCARI CONFERENCE

1. Select the Top Surface Material

Choose between Veneer, Glass, Stone, Fenix with 1mm Edgeband, Fenix with Hardwood edge, Laminate with 2mm Edgeband, or Laminate with Hardwood edge.

2. Select the Top Shape and Edge Profile

Choose between Rectangle, Boat or Round top shapes. Then, based on the top shape and material choices, choose an edge profile. Not all edge profiles are available on each material and top shape. See matrix on page 8 for details.

3. Select the Top Size

Rectangle and Boat Tops are available in 96-240 inch lengths in 12 inch increments. Rectangle tables are available in 42, 48, 54, 60, and 72 inch widths. Boat tables are available in 32/40, 32/44, 36/48, 36/50, 36/54, 42/60, and 54/72 inch widths. Round tables are available in 42-96 inch diameters.

4. Select the Base Style and Panel Finish

Rectangle and Boat tables are available with the following base options: Closed Panel, Open Panel, and Island. Round tables are available with Open or Closed Panel X bases and Column bases.

The wood panel on the base can be finished in veneer or paint for closed panel style and island bases. The open panel bases are available in veneer or painted.

5. Select the Subtop Finish

Subtops can be finished in veneer, or paint. 2-inch thick tops do not have a subtop.

6. Select the Base Reveal Finish

The reveal on Panel Bases can be finished in polished stainless, clear anodized, satin bronze plating, blackened nickel, chemetal, veneer, or powder coat. In open style bases, any visible metal will be finished in the reveal color selection. The reveal on Island Bases is powder coat.

7. Select the Power Options

Tabletop power options available: wireless charging for veneer tables; Power Matrix in compact through extra-large sizes.

Wireless charging can be specified with any other power option on the same table.

Power Matrix is bezel free with a with a door that will match the top on veneer and glass tables. It is bezel free with a glass or metal door on stone tables. It will have a bezel and either a glass or metal door for Fenix or laminate tables.

Power Matrix is available in compact size only on round tables.

Below Table Power options available: Power Drawers, Low Profile Perimeter Power with a Lighted Option, or Power Rail.

The Power Drawers and Low Profile Perimeter Power units are integrated into the subtop. Only one below table power option can be specified on a table. However, both a subtop power and wireless power can be specified for veneer tables that include a subtop.

Modular power is included if a table is specified with Power Drawer, Low Profile Perimeter Power or wireless charging units. It is optional for Power Matrix.



DETAIL OVERVIEW

ASCARI CONFERENCE

Ascari Table offers eight surface materials, five edge profiles, six base options, and a host of premium finish options for the subtop and base panel and metal reveal. In addition, Ascari offers a wide array of power connectivity options and is available in sizes from 42-240 inches in Rectangle, Boat, and Round shapes.

Each base has space for concealed and easily accessible wire management.

A third base is required for tables longer than 144 inches.



TOP MATERIALS

Ascari Conference is available in a variety of top materials and finishes. Choose between Veneer, Glass, Stone, Fenix with 1mm Edgeband, Fenix with Hardwood Edge, Laminate with 2mm Edgeband, or Laminate with Hardwood Edge.

See appendix pages vi-vii for further details on finishes.



TOP SHAPES

RECTANGLE TABLES

Rectangle shape tables come in 96-240 inch lengths in 12 inch increments and 42, 48, 54, 60, and 72 inch widths.



LENGTH	SEATING CAPACITY		WIDTH		
	42	48	54	60	72
96	8	8	-	-	-
108	10	10	10	-	-
120	10	10	10	-	-
132	-	10	10	-	-
144	-	12	12	12-14	-
156	-	14	14	14-16	-
168	-	-	14	14-16	-
180	-	-	16	16-18	-
192	-	-	16	16-18	16-18
204	-	-	16	16-18	16-18
216	-	-	18	18-20	18-20
228	-	-	18	18-20	18-20
240	-	-	18	18-20	18-20

BOAT TABLES

Boat shape tables come in 96-240 inch lengths in 12 inch increments and 32/40, 32/44, 36/48, 36/50, 36/54, 42/60, and 54/72 inch widths.



LENGTH	SEATING CAPACITY		WIDTH		
	36/48	36/50	36/54	42/60	54/72
96	8	-	-	-	-
108	10	-	-	-	-
120	-	10	-	-	-
132	-	-	10	-	-
144	-	-	12	-	-
156	-	-	12	-	-
168	-	-	-	14	-
180	-	-	-	14	-
192	-	-	-	-	16-18
204	-	-	-	-	16-18
216	-	-	-	-	18-20
228	-	-	-	-	18-20
240	-	-	-	-	18-20

ROUND TABLES

Round shape tables come in 42, 48, 54, 60, 72, 84, and 96-inch diameters.



LENGTH	SEATING CAPACITY		WIDTH				
	42	48	54	60	72	84	96
42	4	-	-	-	-	-	-
48	-	4	-	-	-	-	-
54	-	-	4	-	-	-	-
60	-	-	-	4s	-	-	-
72	-	-	-	-	8	-	-
84	-	-	-	-	-	8	-
96	-	-	-	-	-	-	8-10



MATERIAL OPTIONS



EDGE PROFILES



2" Thick

- Veneer

Available on:

- Round
- Rectangle
- Boat



Square

- Veneer
- Laminate
- Fenix
- Glass
- Stone

Available on:

- Round
- Rectangle
- Boat



Square with Metal Detail

- Veneer
- Laminate
- Fenix
- Glass
- Stone

Available on:

- Round
- Rectangle
- Boat



Chamfer

- Veneer
- Stone

Available on:

- Rectangle

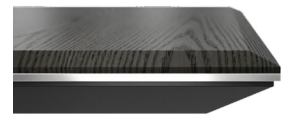

Chamfer with Metal Detail

- Veneer
- Stone

Available on:

- Rectangle

*Rectangle top tables only



EDGE PROFILES

Choose between five beautiful edge profiles:

- 2" Thick
- Square
- Chamfer
- Square with Metal Detail Option
- Chamfer with Metal Detail Option

Not all edge profiles are available with each top material and shape. See the matrix below.

All edge profiles, except for the 2" Thick come with a wood subtop. The subtop can be finished in veneer or paint. More details on finishes can be found on appendix pages vi-vii.

The metal detail option on the subtop can be finished in powder coat, polished stainless or clear anodized. It is flush with the top of the table.

2" Thick Edge

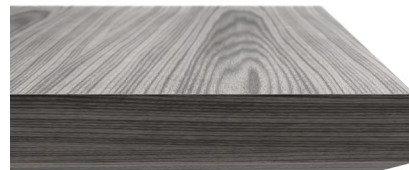

Square Edge



Square Edge with Metal Detail Option



Chamfer Edge



Chamfer Edge with Metal Detail Option



TOP MATERIAL	MATERIAL THICKNESS	SUBTOP THICKNESS
Glass	0.375"	1.875"
Stone	2cm	1.875"
Veneer	.75"	1.875"
2" Veneer	2.375"	None
Fenix	.75"	1.875"
Laminate	.75"	1.875"

Veneer Chamfer Dimensions

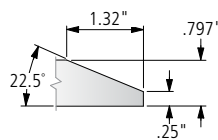

Stone Chamfer Dimensions

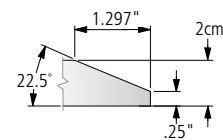

Please Note: All tables have a 27" clearance for ADA compliance.

EDGE PROFILE AVAILABILITY BY SURFACE MATERIAL

	2" THICK	SQUARE	CHAMFER	SQUARE WITH METAL DETAIL	CHAMFER WITH METAL DETAIL
VEENEER	X	X	X	X	X
LAMINATE		X		X	
FENIX		X		X	
GLASS		X		X	X
STONE		X	X	X	X

EDGE PROFILE AVAILABILITY BY TOP SHAPE

	2" THICK	SQUARE	CHAMFER	SQUARE WITH METAL DETAIL	CHAMFER WITH METAL DETAIL
ROUND	X	X		X	
RECTANGLE	X	X	X	X	X
BOAT	X	X		X	



BASE STYLES

Ascari Conference has six base styles:

- Closed Panel
- Open Panel
- Closed Panel X
- Open Panel X
- Island Base
- Column Base

Rectangle and boat shape tables are available with Closed Panel, Open Panel and Island bases. Round tables can have open or closed panel X bases or a column base.

Each base style has built in, concealed and easily accessible wire management.

Each of the panel bases has wood panels and a 2-inch metal reveal. The wood panels are available in veneer or paint. The reveal can be finished in polished stainless, satin bronze plating, clear anodized, chemetal, veneer, or powder coat. If the interior of the base is visible (as in the open panel bases) then the interior defaults to the reveal finish.

The island base panels have the same finish options as the panel bases. The metal reveal is available in powder coat only.

The column base is available in polished chrome or powder coat. The column base is available for 42 and 48 inch round tables exclusively.

A third base is required for tables longer than 144 inches.

Closed Panel

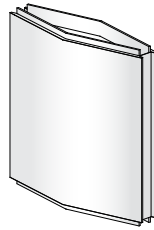

Open Panel

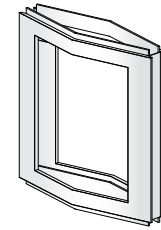

Closed Panel X

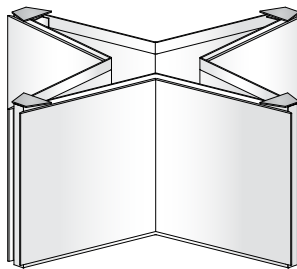

Open Panel X

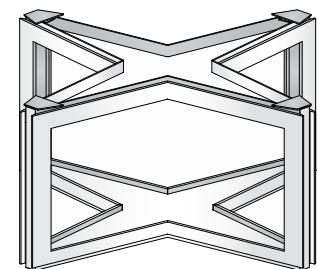

Island Base

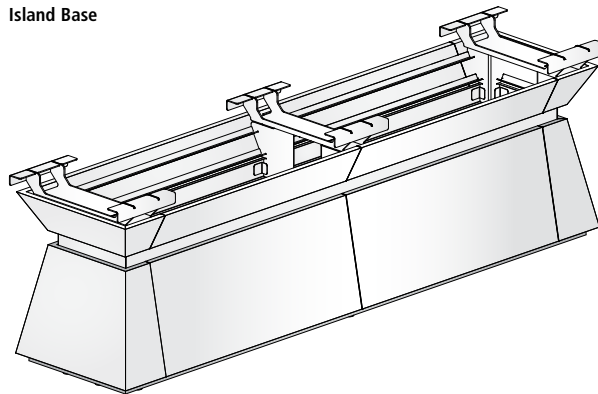

Column Base

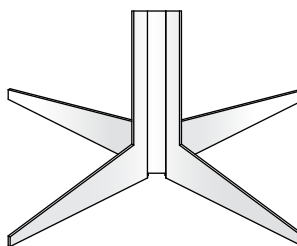



TABLE TOP POWER OPTION: POWER MATRIX

Power Matrix is filled with a broad array of high performance features and refined aesthetic elements.

POWER

Power Matrix features simplex receptacles for power connectivity, the quantity of which is pre-determined based on the size of the unit. An optional USB-A+C charger can also be specified in place of one of the simplex receptacles when desired. Corded or hardwired infeed options add flexibility.

DATA/AV FACEPLATES

Power Matrix accommodates Extron Architectural Adaptor Plates (AAPs) for unparalleled flexibility in data and AV connectivity.

DESIGN

Veneer top tables are available with a veneer, glass or metal Power Matrix door. Glass, Stone, Laminate and Fenix top tables are available with either a glass or metal Power Matrix door.

Laminate and Fenix tables will have Power Matrix units that include a bezel. Veneer, Glass and Stone top tables will have Power Matrix units without a bezel. Metal Power Matrix doors can be finished in powder coat, polished chrome or clear anodized. The bezel can be finished in powder coat or polished chrome.

PowerMatrix units feature a clear anodized aluminum body design. The metal and wood door on the Power Matrix features the signature “file folder” design classic to the Ascari Collection. Glass doors are square without the “file folder” design.

PERFORMANCE

Friction hinges ensure smooth travel through the door’s range of motion and can hold the door in any position. Hidden door stops maintain the minimalist aesthetic. Cable storage is both concealed and ample.

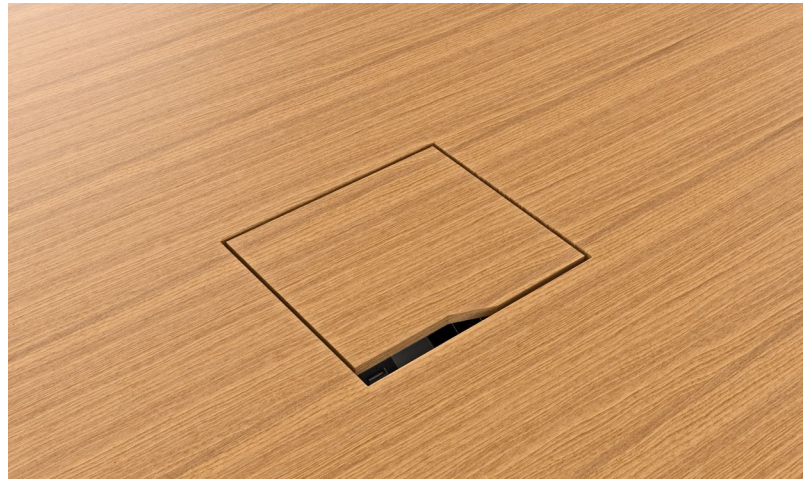

Power Matrix Medium shown



TABLE TOP POWER OPTION: POWER MATRIX

STANDARD CONFIGURATIONS

Power Matrix is offered in four standard sizes, each with a pre-determined quantity of simplex outlets and AV faceplates. With each size, an optional 2 amp USB-A+C charger (1 amp per port) replaces one of the simplex outlets.

Small and Compact

- Single door design
- 5.375" x 6" cutout
- Two simplex outlets
- Three AV faceplates. Standard configuration includes two blank faceplates and one faceplate with two RJ-45 (data) connectors.
- (1) 12' plug-in infeed cord

Standard

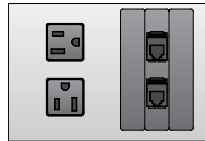

Medium

- Single door design
- 5.375" x 8.25" cutout
- Four simplex outlets
- Four AV faceplates. Standard configuration includes three blank faceplates and one faceplate with two RJ-45 (data) connectors.
- (1) 12' plug-in infeed cord

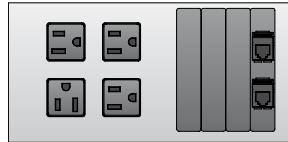

Large

- Double door design
- 10.75" x 15.25" cutout
- Six simplex outlets (three per side)
- Six AV faceplates (three per side). Standard configuration includes two blank faceplates and one faceplate with two RJ-45 (data) connectors per side.
- (2) 12' plug-in infeed cords

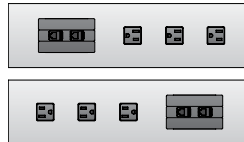

Extra Large

- Double door design
- 10.75" x 30.25" cutout
- Eight simplex outlets (four per side)
- Twelve AV faceplates (six per side). Standard configuration includes four blank faceplates and two faceplates with two RJ-45 (data) connectors per side.
- (2) 12' plug-in infeed cords



Field-Wired

Some local electrical codes may require field-wiring during installation. In such instances, a Field-Wired option may be specified. In this configuration, each Power Matrix unit will be supplied with a 6' flexible metal conduit with hot, ground and neutral wires.

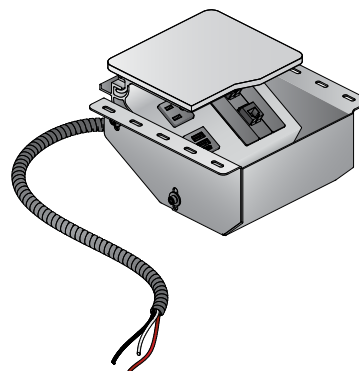

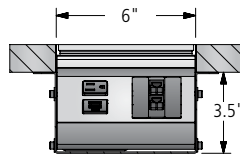
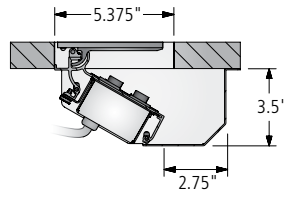

TABLE TOP POWER OPTION: POWER MATRIX

DIMENSIONS

Each Power Matrix unit includes a low-profile pan beneath the work surface to conceal the unit and provide ample storage capacity for excess cables. The size of the cut-out in the table top varies with each size of Power Matrix unit.

Small



Compact

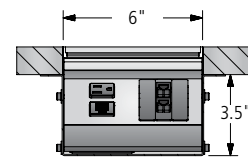
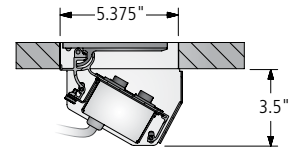

Medium

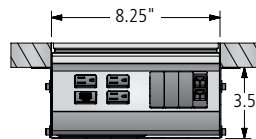
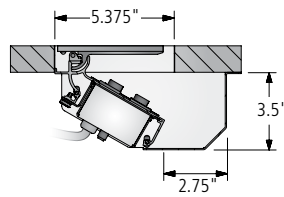

Large

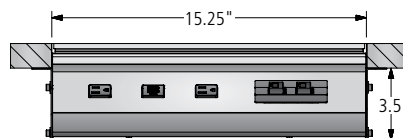
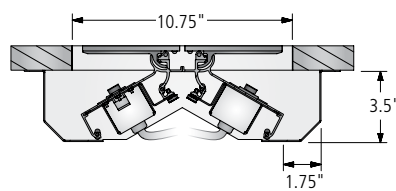

Extra Large

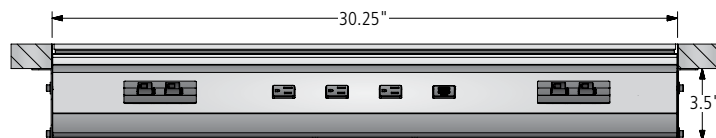
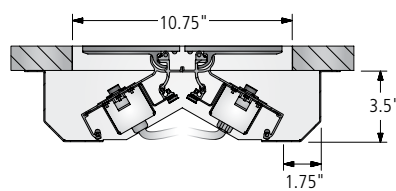



TABLE TOP POWER OPTION: POWER MATRIX

POWER PLANNING

Power Matrix is available with two options for connection with building power:

DIRECT PLUG-IN

The 15-amp power cord from each Power Matrix unit is plugged into a floor monument. The floor monument must have at least one power outlet per small or medium Power Matrix unit in the table and two power outlets per large or extra large Power Matrix (e.g., a table with four small or medium Power Matrix units would need four power outlets in the floor monument).

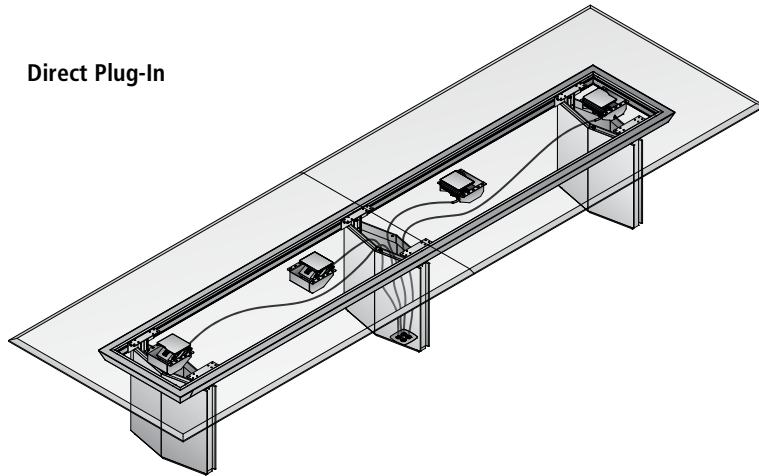

Single In-Feed

SINGLE INFEEED

Each Power Matrix unit is plugged into a two-circuit modular electrical system in the table from which a single connection is made to a floor monument. This connection can be either hardwired (to utilize both of the circuits in the modular electrical system) or corded (which requires a 20-amp power outlet in the floor monument and reduces the modular electrical system in the table to a single circuit).

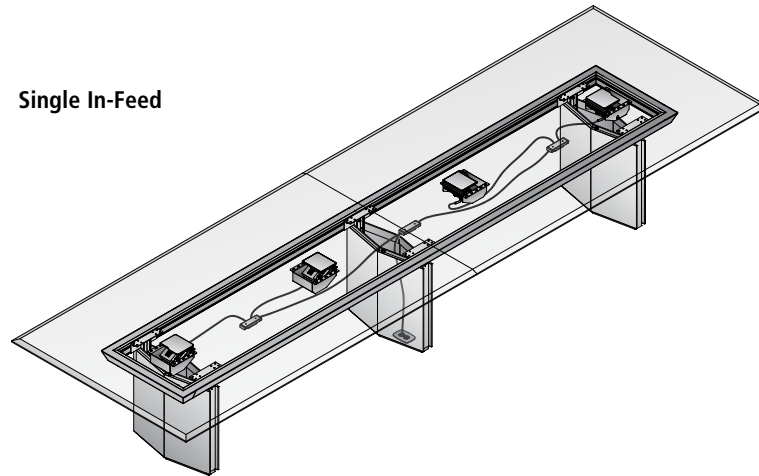

Two-Circuit Modular Electrical System

- 4-wire, 20-amp, 2-circuit modular electrical system
- Only present on tables specified with the Single In-Feed option
- Hardwire or corded (20-amp) in-feed options. A licensed electrician is required to complete hardwire connections to building's power source.
- Neutral (white) wires are 10 gauge, hot and ground wires are 12 gauge
- All electrical components satisfy National Electrical Code (NEC) requirements and are UL listed

Electrical Diagram — Hardwire Power Infeed Only

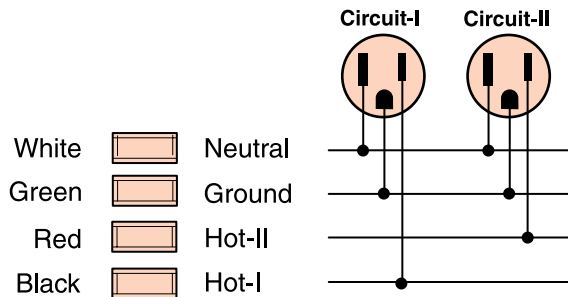



TABLE TOP POWER OPTION: POWER MATRIX

LOCATION CODES

Power Matrix is offered in a variety of locations and quantities per table size, offering a broad range of performance and pricing options.

POWER MATRIX SMALL	POWER MATRIX MEDIUM	POWER MATRIX LARGE	POWER MATRIX EXTRA LARGE	LOCATION	QUANTITY OF UNITS TO ORDER
PS-1	PM-1	PL-1	PX-1	One at center	1
PS-2	PM-2	PL-2	PX-2	One at each end	2
PS-3	PM-3	PL-3	PX-3	One at center and one at each end	3
PS-4	PM-4			Four equally spaced (tables 132" and longer)	4

DOOR MATERIAL AVAILABILITY BY SURFACE MATERIAL

	MOUNT STYLE	WOOD DOOR (W)	GLASS DOOR (G)	METAL DOOR (M)
VENEER	Bezel-free	X	X	X
LAMINATE	Bezel		X	X
FENIX	Bezel		X	X
GLASS	Bezel-free		X	X
STONE	Bezel-free		X	X

ROUND TABLES: TOP SECTIONS, DOOR MATERIAL AND POWER MATRIX AVAILABILITY BY TABLE SIZE

W = Wood Door G = Glass Door M = Metal Door

Length	Power Matrix Compact				Power Matrix Medium				Power Matrix Large			Power Matrix Extra Large		
	PS-1	PS-2	PS-3	PS-4	PM-1	PM-2	PM-3	PM-4	PL-1	PL-2	PL-3	PX-1	PX-2	PX-3
42	1 W/G/M	-	-	-	-	-	-	-	-	-	-	-	-	-
48	1 W/G/M	-	-	-	-	-	-	-	-	-	-	-	-	-
54	1 W/G/M	-	-	-	-	-	-	-	-	-	-	-	-	-
60	1 W/G/M	-	-	-	-	-	-	-	-	-	-	-	-	-
72	-	2 W/G/M	-	-	-	-	-	-	-	-	-	-	-	-
84	-	2 W/G/M	-	-	-	-	-	-	-	-	-	-	-	-
96	-	2 W/G/M	-	-	-	-	-	-	-	-	-	-	-	-

Note: Power Matrix is not available on Round Tables with a Column Base.



TABLE TOP POWER OPTION: POWER MATRIX

VENEER TOP RECTANGLE AND BOAT TABLES: TOP SECTIONS, DOOR MATERIAL AND POWER MATRIX AVAILABILITY BY TABLE SIZE

W = Wood Door G = Glass Door M = Metal Door

Length	Power Matrix Small				Power Matrix Medium				Power Matrix Large			Power Matrix Extra Large		
	PS-1	PS-2	PS-3	PS-4	PM-1	PM-2	PM-3	PM-4	PL-1	PL-2	PL-3	PX-1	PX-2	PX-3
96 x 42	1	1	1	-	1	1	1	-	1	-	-	1	-	-
96 x 48	1	1	1	-	1	1	1	-	1	-	-	1	-	-
108 x 42	1	1	1	-	1	1	1	-	1	-	-	1	-	-
108 x 48	1	1	1	-	1	1	1	-	1	-	-	1	-	-
108 x 54	1	1	1	-	1	1	1	-	1	-	-	1	-	-
120 x 42†	1	1	1	-	1	1	1	-	1	-	-	1	-	-
120 x 48†	1	1	1	-	1	1	1	-	1	-	-	1	-	-
120 x 54†	1	1	1	-	1	1	1	-	1	-	-	1	-	-
132 x 48	-	2	-	2	-	2	-	2	2	-	-	2	-	-
132 x 54	-	2	-	2	-	2	-	2	2	-	-	2	-	-
144 x 48	-	2	-	2	-	2	-	2	2	2	-	2	2	-
144 x 54	-	2	-	2	-	2	-	2	2	2	-	2	2	-
144 x 60	-	2	-	2	-	2	-	2	2	2	-	2	2	-
156 x 48	-	2	-	2	-	2	-	2	2	2	-	2	2	-
156 x 54	-	2	-	2	-	2	-	2	2	2	-	2	2	-
156 x 60	-	2	-	2	-	2	-	2	2	2	-	2	2	-
168 x 54	-	2	-	2	-	2	-	2	2	2	-	2	2	-
168 x 60	-	2	-	2	-	2	-	2	2	2	-	2	2	-
180 x 54	-	2	-	2	-	2	-	2	2	2	-	2	2	-
180 x 60	-	2	-	2	-	2	-	2	2	2	-	2	2	-
192 x 54	-	2	-	2	-	2	-	2	2	2	-	2	2	-
192 x 60	-	2	-	2	-	2	-	2	2	2	-	2	2	-
192 x 72	-	4	-	4	-	4	-	4	4	4	-	4	4	-
204 x 54	-	2	-	2	-	2	-	2	2	2	-	2	2	-
204 x 60	-	2	-	2	-	2	-	2	2	2	-	2	2	-
204 x 72	-	4	-	4	-	4	-	4	4	4	-	4	4	-
216 x 54	-	2	-	2	-	2	-	2	2	2	2	2	2	2
216 x 60	-	2	-	2	-	2	-	2	2	2	2	2	2	2
216 x 72	-	4	-	4	-	4	-	4	4	4	4	4	4	4
228 x 54	-	2	-	2	-	2	-	2	2	2	2	2	2	2
228 x 60	-	2	-	2	-	2	-	2	2	2	2	2	2	2
228 x 72	-	4	-	4	-	4	-	4	4	4	4	4	4	4
240 x 54	-	2	-	2	-	2	-	2	2	2	2	2	2	2
240 x 60	-	2	-	2	-	2	-	2	2	2	2	2	2	2
240 x 72	-	4	-	4	-	4	-	4	4	4	4	4	4	4

† See page 16 for Power Matrix availability and top sections on 120" L Veneer Top Tables with Chamfer Edge

* PL-1 and PX-1 not available on tables with an Island Base



TABLE TOP POWER OPTION: POWER MATRIX

120" VENEER TOP RECTANGLE TABLES WITH CHAMFER EDGE: TOP SECTIONS, DOOR MATERIAL AND POWER MATRIX AVAILABILITY BY TABLE SIZE

W = Wood Door G = Glass Door M = Metal Door

Length	Power Matrix Small				Power Matrix Medium				Power Matrix Large			Power Matrix Extra Large		
	PS-1	PS-2	PS-3	PS-4	PM-1	PM-2	PM-3	PM-4	PL-1	PL-2	PL-3	PX-1	PX-2	PX-3
120 x 42	-	2 W/G/M	-	-	-	2 W/G/M	-	-	1 W/G/M	-	-	1 W/G/M	-	-
120 x 48	-	2 W/G/M	-	-	-	2 W/G/M	-	-	1 W/G/M	-	-	1 W/G/M	-	-
120 x 54	-	2 W/G/M	-	-	-	2 W/G/M	-	-	1 W/G/M	-	-	1 W/G/M	-	-



TABLE TOP POWER OPTION: POWER MATRIX

LAMINATE AND FENIX TOP RECTANGLE AND BOAT TABLES: TOP SECTIONS, DOOR MATERIAL AND POWER MATRIX AVAILABILITY BY TABLE SIZE

W = Wood Door G = Glass Door M = Metal Door

Length	Power Matrix Small				Power Matrix Medium				Power Matrix Large			Power Matrix Extra Large		
	PS-1	PS-2	PS-3	PS-4	PM-1	PM-2	PM-3	PM-4	PL-1	PL-2	PL-3	PX-1	PX-2	PX-3
96 x 42	1 G/M	1 G/M	1 G/M	-	1 G/M	1 G/M	1 G/M	-	1 G/M	-	-	1 G/M	-	-
96 x 48	1 G/M	1 G/M	1 G/M	-	1 G/M	1 G/M	1 G/M	-	1 G/M	-	-	1 G/M	-	-
108 x 42	1 G/M	1 G/M	1 G/M	-	1 G/M	1 G/M	1 G/M	-	1 G/M	-	-	1 G/M	-	-
108 x 48	1 G/M	1 G/M	1 G/M	-	1 G/M	1 G/M	1 G/M	-	1 G/M	-	-	1 G/M	-	-
108 x 54	1 G/M	1 G/M	1 G/M	-	1 G/M	1 G/M	1 G/M	-	1 G/M	-	-	1 G/M	-	-
120 x 42	1 G/M	1 G/M	1 G/M	-	1 G/M	1 G/M	1 G/M	-	1 G/M	-	-	1 G/M	-	-
120 x 48	1 G/M	1 G/M	1 G/M	-	1 G/M	1 G/M	1 G/M	-	1 G/M	-	-	1 G/M	-	-
120 x 54	1 G/M	1 G/M	1 G/M	-	1 G/M	1 G/M	1 G/M	-	1 G/M	-	-	1 G/M	-	-
132 x 48	-	2 G/M	-	2 G/M	-	2 G/M	-	2 G/M	2 G/M	-	-	2 G/M	-	-
132 x 54	-	2 G/M	-	2 G/M	-	2 G/M	-	2 G/M	2 G/M	-	-	2 G/M	-	-
144 x 48	-	2 G/M	-	2 G/M	-	2 G/M	-	2 G/M	2 G/M	2 G/M	-	2 G/M	2 G/M	-
144 x 54	-	2 G/M	-	2 G/M	-	2 G/M	-	2 G/M	2 G/M	2 G/M	-	2 G/M	2 G/M	-
144 x 60	-	2 G/M	-	2 G/M	-	2 G/M	-	2 G/M	2 G/M	2 G/M	-	2 G/M	2 G/M	-
156 x 48	-	2 G/M	-	2 G/M	-	2 G/M	-	2 G/M	2 G/M*	2 G/M	-	2 G/M*	2 G/M	-
156 x 54	-	2 G/M	-	2 G/M	-	2 G/M	-	2 G/M	2 G/M*	2 G/M	-	2 G/M*	2 G/M	-
156 x 60	-	2 G/M	-	2 G/M	-	2 G/M	-	2 G/M	2 G/M*	2 G/M	-	2 G/M*	2 G/M	-
168 x 54	-	2 G/M	-	2 G/M	-	2 G/M	-	2 G/M	2 G/M*	2 G/M	-	2 G/M*	2 G/M	-
168 x 60	-	2 G/M	-	2 G/M	-	2 G/M	-	2 G/M	2 G/M*	2 G/M	-	2 G/M*	2 G/M	-
180 x 54	-	2 G/M	-	2 G/M	-	2 G/M	-	2 G/M	2 G/M	2 G/M	-	2 G/M	2 G/M	-
180 x 60	-	2 G/M	-	2 G/M	-	2 G/M	-	2 G/M	2 G/M	2 G/M	-	2 G/M	2 G/M	-
192 x 54	-	2 G/M	-	2 G/M	-	2 G/M	-	2 G/M	2 G/M	2 G/M	-	2 G/M	2 G/M	-
192 x 60	-	2 G/M	-	2 G/M	-	2 G/M	-	2 G/M	2 G/M	2 G/M	-	2 G/M	2 G/M	-
192 x 72	-	4 G/M	-	4 G/M	-	4 G/M	-	4 G/M	4 G/M	4 G/M	-	4 G/M	4 G/M	-
204 x 54	-	2 G/M	-	2 G/M	-	2 G/M	-	2 G/M	2 G/M	2 G/M	-	2 G/M	2 G/M	-
204 x 60	-	2 G/M	-	2 G/M	-	2 G/M	-	2 G/M	2 G/M	2 G/M	-	2 G/M	2 G/M	-
204 x 72	-	4 G/M	-	4 G/M	-	4 G/M	-	4 G/M	4 G/M	4 G/M	-	4 G/M	4 G/M	-
216 x 54	-	2 G/M	-	2 G/M	-	2 G/M	-	2 G/M	2 G/M	2 G/M	2 G/M	2 G/M	2 G/M	2 G/M
216 x 60	-	2 G/M	-	2 G/M	-	2 G/M	-	2 G/M	2 G/M	2 G/M	2 G/M	2 G/M	2 G/M	2 G/M
216 x 72	-	4 G/M	-	4 G/M	-	4 G/M	-	4 G/M	4 G/M	4 G/M	4 G/M	4 G/M	4 G/M	4 G/M
228 x 54	-	2 G/M	-	2 G/M	-	2 G/M	-	2 G/M	2 G/M	2 G/M	2 G/M	2 G/M	2 G/M	2 G/M
228 x 60	-	2 G/M	-	2 G/M	-	2 G/M	-	2 G/M	2 G/M	2 G/M	2 G/M	2 G/M	2 G/M	2 G/M
228 x 72	-	4 G/M	-	4 G/M	-	4 G/M	-	4 G/M	4 G/M	4 G/M	4 G/M	4 G/M	4 G/M	4 G/M
240 x 54	-	2 G/M	-	2 G/M	-	2 G/M	-	2 G/M	2 G/M	2 G/M	2 G/M	2 G/M	2 G/M	2 G/M
240 x 60	-	2 G/M	-	2 G/M	-	2 G/M	-	2 G/M	2 G/M	2 G/M	2 G/M	2 G/M	2 G/M	2 G/M
240 x 72	-	4 G/M	-	4 G/M	-	4 G/M	-	4 G/M	4 G/M	4 G/M	4 G/M	4 G/M	4 G/M	4 G/M

*PL-1 and PX-1 not available on tables with an Island Base



TABLE TOP POWER OPTION: POWER MATRIX

GLASS TOP RECTANGLE AND BOAT TABLES: TOP SECTIONS, DOOR MATERIAL AND POWER MATRIX AVAILABILITY BY TABLE SIZE

G = Glass Door M = Metal Door

Length	Power Matrix Small				Power Matrix Medium				Power Matrix Large			Power Matrix Extra Large		
	PS-1	PS-2	PS-3	PS-4	PM-1	PM-2	PM-3	PM-4	PL-1	PL-2	PL-3	PX-1	PX-2	PX-3
96 x 42	1 G/M	1 G/M	1 G/M	-	1 G/M	1 G/M	1 G/M	-	1 G/M	-	-	1 G/M	-	-
96 x 48	1 G/M	1 G/M	1 G/M	-	1 G/M	1 G/M	1 G/M	-	1 G/M	-	-	1 G/M	-	-
108 x 42	1 G/M	1 G/M	1 G/M	-	1 G/M	1 G/M	1 G/M	-	1 G/M	-	-	1 G/M	-	-
108 x 48	3 G/M	2 G/M	3 G/M	-	3 G/M	2 G/M	3 G/M	-	3 G/M	-	-	3 G/M	-	-
108 x 54	3 G/M	2 G/M	3 G/M	-	3 G/M	2 G/M	3 G/M	-	3 G/M	-	-	3 G/M	-	-
120 x 42	1 G/M	1 G/M	1 G/M	-	1 G/M	1 G/M	1 G/M	-	1 G/M	-	-	1 G/M	-	-
120 x 48	3 G/M	2 G/M	3 G/M	-	3 G/M	2 G/M	3 G/M	-	3 G/M	-	-	3 G/M	-	-
120 x 54	1 G/M	1 G/M	1 G/M	-	1 G/M	1 G/M	1 G/M	-	3 G/M	-	-	3 G/M	-	-
132 x 48	-	2 G/M	-	2 G/M	-	2 G/M	-	2 G/M	3 G/M	-	-	3 G/M	-	-
132 x 54	-	2 G/M	-	2 G/M	-	2 G/M	-	2 G/M	3 G/M	-	-	3 G/M	-	-
144 x 48	-	2 G/M	-	2 G/M	-	2 G/M	-	2 G/M	3 G/M	2 G/M	-	3 G/M	2 G/M	-
144 x 54	-	2 G/M	-	2 G/M	-	2 G/M	-	2 G/M	3 G/M	2 G/M	-	3 G/M	2 G/M	-
144 x 60	-	2 G/M	-	2 G/M	-	2 G/M	-	2 G/M	3 G/M	2 G/M	-	3 G/M	2 G/M	-
156 x 48	-	2 G/M	-	2 G/M	-	2 G/M	-	2 G/M	3 G/M*	2 G/M	-	3 G/M*	2 G/M	-
156 x 54	-	2 G/M	-	2 G/M	-	2 G/M	-	2 G/M	3 G/M*	2 G/M	-	3 G/M*	2 G/M	-
156 x 60	-	2 G/M	-	2 G/M	-	2 G/M	-	2 G/M	3 G/M*	2 G/M	-	3 G/M*	2 G/M	-
168 x 54	-	2 G/M	-	2 G/M	-	2 G/M	-	2 G/M	3 G/M*	2 G/M	-	3 G/M*	2 G/M	-
168 x 60	-	2 G/M	-	2 G/M	-	2 G/M	-	2 G/M	3 G/M*	2 G/M	-	3 G/M*	2 G/M	-
180 x 54	-	2 G/M	-	2 G/M	-	2 G/M	-	2 G/M	3 G/M	2 G/M	-	3 G/M	2 G/M	-
180 x 60	-	3 G/M	-	3 G/M	-	3 G/M	-	3 G/M	3 G/M	3 G/M	-	3 G/M	3 G/M	-
192 x 54	-	3 G/M	-	3 G/M	-	3 G/M	-	3 G/M	3 G/M	3 G/M	-	3 G/M	3 G/M	-
192 x 60	-	3 G/M	-	3 G/M	-	3 G/M	-	3 G/M	3 G/M	3 G/M	-	3 G/M	3 G/M	-
192 x 72	-	4 G/M	-	4 G/M	-	4 G/M	-	4 G/M	5 G/M	4 G/M	-	-	-	-
204 x 54	-	3 G/M	-	3 G/M	-	3 G/M	-	3 G/M	3 G/M	3 G/M	-	3 G/M	3 G/M	-
204 x 60	-	3 G/M	-	3 G/M	-	3 G/M	-	3 G/M	3 G/M	3 G/M	-	3 G/M	3 G/M	-
204 x 72	-	4 G/M	-	4 G/M	-	4 G/M	-	4 G/M	5 G/M	5 G/M	-	-	-	-
216 x 54	-	3 G/M	-	3 G/M	-	3 G/M	-	3 G/M	3 G/M	3 G/M	3 G/M	3 G/M	3 G/M	3 G/M
216 x 60	-	3 G/M	-	3 G/M	-	3 G/M	-	3 G/M	3 G/M	3 G/M	3 G/M	3 G/M	3 G/M	3 G/M
216 x 72	-	4 G/M	-	4 G/M	-	4 G/M	-	4 G/M	5 G/M	5 G/M	5 G/M	-	-	-
228 x 54	-	3 G/M	-	3 G/M	-	3 G/M	-	3 G/M	3 G/M	3 G/M	3 G/M	3 G/M	3 G/M	3 G/M
228 x 60	-	3 G/M	-	3 G/M	-	3 G/M	-	3 G/M	3 G/M	3 G/M	3 G/M	3 G/M	3 G/M	3 G/M
228 x 72	-	4 G/M	-	4 G/M	-	4 G/M	-	4 G/M	5 G/M	5 G/M	5 G/M	-	-	-
240 x 54	-	3 G/M	-	3 G/M	-	3 G/M	-	3 G/M	3 G/M	3 G/M	3 G/M	3 G/M	3 G/M	3 G/M
240 x 60	-	3 G/M	-	3 G/M	-	3 G/M	-	3 G/M	3 G/M	3 G/M	3 G/M	3 G/M	3 G/M	3 G/M
240 x 72	-	4 G/M	-	4 G/M	-	4 G/M	-	4 G/M	5 G/M	5 G/M	5 G/M	-	-	-

*PL-1 and PX-1 not available on tables with an Island Base



TABLE TOP POWER OPTION: POWER MATRIX

STONE TOP RECTANGLE AND BOAT TABLES: TOP SECTIONS, DOOR MATERIAL AND POWER MATRIX AVAILABILITY BY TABLE SIZE

G = Glass Door M = Metal Door

Length	Power Matrix Small				Power Matrix Medium				Power Matrix Large			Power Matrix Extra Large		
	PS-1	PS-2	PS-3	PS-4	PM-1	PM-2	PM-3	PM-4	PL-1	PL-2	PL-3	PX-1	PX-2	PX-3
96 x 42	1 G/M	1 G/M	1 G/M	-	1 G/M	1 G/M	1 G/M	-	1 G/M	-	-	1 G/M	-	-
96 x 48	3 G/M	2 G/M	3 G/M	-	3 G/M	2 G/M	3 G/M	-	3 G/M	-	-	3 G/M	-	-
108 x 42	1 G/M	1 G/M	1 G/M	-	1 G/M	1 G/M	1 G/M	-	1 G/M	-	-	1 G/M	-	-
108 x 48	3 G/M	2 G/M	3 G/M	-	3 G/M	2 G/M	3 G/M	-	3 G/M	-	-	3 G/M	-	-
108 x 54	3 G/M	2 G/M	3 G/M	-	3 G/M	2 G/M	3 G/M	-	3 G/M	-	-	3 G/M	-	-
120 x 42	3 G/M	2 G/M	3 G/M	-	3 G/M	2 G/M	3 G/M	-	3 G/M	-	-	3 G/M	-	-
120 x 48	3 G/M	2 G/M	3 G/M	-	3 G/M	2 G/M	3 G/M	-	3 G/M	-	-	3 G/M	-	-
120 x 54	3 G/M	2 G/M	3 G/M	-	3 G/M	2 G/M	3 G/M	-	3 G/M	-	-	3 G/M	-	-
132 x 48	-	2 G/M	-	2 G/M	-	2 G/M	-	2 G/M	3 G/M	-	-	3 G/M	-	-
132 x 54	-	2 G/M	-	2 G/M	-	2 G/M	-	2 G/M	3 G/M	-	-	3 G/M	-	-
144 x 48	-	2 G/M	-	2 G/M	-	2 G/M	-	2 G/M	3 G/M	2 G/M	-	3 G/M	2 G/M	-
144 x 54	-	2 G/M	-	2 G/M	-	2 G/M	-	2 G/M	3 G/M	2 G/M	-	3 G/M	2 G/M	-
144 x 60	-	2 G/M	-	2 G/M	-	2 G/M	-	2 G/M	3 G/M	2 G/M	-	3 G/M	2 G/M	-
156 x 48	-	2 G/M	-	2 G/M	-	2 G/M	-	2 G/M	3 G/M*	2 G/M	-	3 G/M*	2 G/M	-
156 x 54	-	2 G/M	-	2 G/M	-	2 G/M	-	2 G/M	3 G/M*	2 G/M	-	3 G/M*	2 G/M	-
156 x 60	-	3 G/M	-	3 G/M	-	3 G/M	-	3 G/M	3 G/M*	3 G/M	-	3 G/M*	3 G/M	-
168 x 54	-	2 G/M	-	2 G/M	-	2 G/M	-	2 G/M	3 G/M*	2 G/M	-	3 G/M*	2 G/M	-
168 x 60	-	3 G/M	-	3 G/M	-	3 G/M	-	3 G/M	3 G/M*	3 G/M	-	3 G/M*	3 G/M	-
180 x 54	-	3 G/M	-	3 G/M	-	3 G/M	-	3 G/M	3 G/M	3 G/M	-	3 G/M	3 G/M	-
180 x 60	-	3 G/M	-	3 G/M	-	3 G/M	-	3 G/M	3 G/M	3 G/M	-	3 G/M	3 G/M	-
192 x 54	-	3 G/M	-	3 G/M	-	3 G/M	-	3 G/M	3 G/M	3 G/M	-	3 G/M	3 G/M	-
192 x 60	-	3 G/M	-	3 G/M	-	3 G/M	-	3 G/M	3 G/M	3 G/M	-	3 G/M	3 G/M	-
192 x 72	-	4 G/M	-	4 G/M	-	4 G/M	-	4 G/M	5 G/M	4 G/M	-	5 G/M	4 G/M	-
204 x 54	-	3 G/M	-	3 G/M	-	3 G/M	-	3 G/M	3 G/M	3 G/M	-	3 G/M	4 G/M	-
204 x 60	-	3 G/M	-	3 G/M	-	3 G/M	-	3 G/M	3 G/M	3 G/M	-	3 G/M	4 G/M	-
204 x 72	-	4 G/M	-	4 G/M	-	4 G/M	-	4 G/M	5 G/M	5 G/M	-	5 G/M	5 G/M	-
216 x 54	-	3 G/M	-	3 G/M	-	3 G/M	-	3 G/M	3 G/M	3 G/M	3 G/M	3 G/M	4 G/M	5 G/M
216 x 60	-	3 G/M	-	3 G/M	-	3 G/M	-	3 G/M	3 G/M	3 G/M	3 G/M	3 G/M	4 G/M	5 G/M
216 x 72	-	4 G/M	-	4 G/M	-	4 G/M	-	4 G/M	5 G/M	5 G/M	5 G/M	5 G/M	5 G/M	5 G/M
228 x 54	-	3 G/M	-	3 G/M	-	3 G/M	-	3 G/M	3 G/M	3 G/M	3 G/M	3 G/M	3 G/M	3 G/M
228 x 60	-	4 G/M	-	4 G/M	-	4 G/M	-	4 G/M	5 G/M	4 G/M	5 G/M	5 G/M	4 G/M	5 G/M
228 x 72	-	4 G/M	-	4 G/M	-	4 G/M	-	4 G/M	5 G/M	5 G/M	5 G/M	5 G/M	5 G/M	5 G/M
240 x 54	-	3 G/M	-	3 G/M	-	3 G/M	-	3 G/M	3 G/M	3 G/M	3 G/M	3 G/M	3 G/M	3 G/M
240 x 60	-	4 G/M	-	4 G/M	-	4 G/M	-	4 G/M	5 G/M	5 G/M	5 G/M	5 G/M	5 G/M	5 G/M
240 x 72	-	4 G/M	-	4 G/M	-	4 G/M	-	4 G/M	5 G/M	5 G/M	5 G/M	5 G/M	5 G/M	5 G/M

*PL-1 and PX-1 not available on tables with an Island Base



TABLE TOP POWER OPTION: POWER MATRIX

POWER MATRIX COMPACT, SMALL OR MEDIUM LOCATION OPTIONS

Please Note: For floor core placement, please reference base location information on ss 34-35.

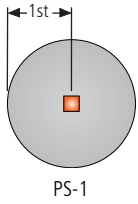

PS-1	
Diameter	Center of Power Matrix
42	21
48	24
54	27
60	30

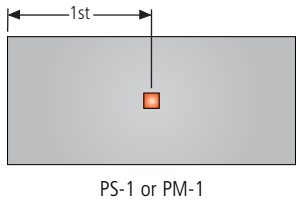

PS-1 or PM-1	
Length	Center of Power Matrix
96	48
108	54
120	60

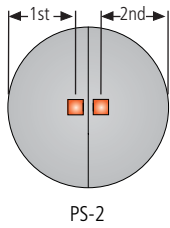

PS-2		
Diameter	Center of 1st Power Matrix	Center of 2nd Power Matrix
72	30.5	30.5
84	35	35
96	36	36

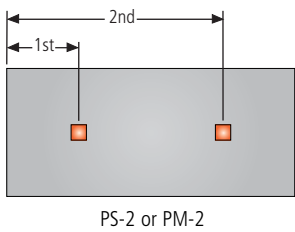

PS-2 or PM-2		
Length	Center of 1st Power Matrix	Center of 2nd Power Matrix
96	26	70
108	26	82
120	26	94
132	26	106
144	26	118
156	26	130
168	26	142
180	26	154
192	26	166
204	26	178
216	26	190
228	26	202
240	26	214



TABLE TOP POWER OPTION: POWER MATRIX

POWER MATRIX COMPACT, SMALL OR MEDIUM LOCATION OPTIONS

Please Note: For floor core placement, please reference base location information on page 38.

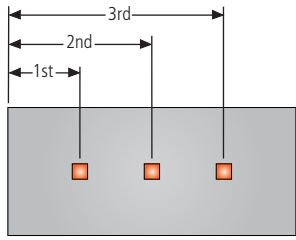

PS-3 or PM-3

PS-3 or PM-3			
Length	Center of 1st Power Matrix	Center of 2nd Power Matrix	Center of 3rd Power Matrix
96	26	48	70
108	26	54	82
120	26	60	94

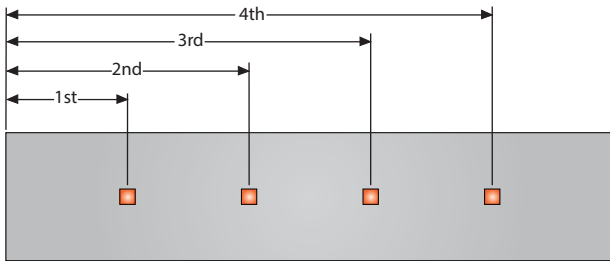

PS-4 or PM-4

PS-4 or PM-4				
Length	Center of 1st Power Matrix	Center of 2nd Power Matrix	Center of 3rd Power Matrix	Center of 4th Power Matrix
132	26	53	79	106
144	26	57	87	118
156	26	61	95	130
168	26	65	103	142
180	26	69	111	154
192	26	73	119	166
204	26	77	127	178
216	26	81	135	190
228	26	85	143	202
240	26	89	151	214



TABLE TOP POWER OPTION: POWER MATRIX

POWER MATRIX LARGE OR EXTRA LARGE LOCATION OPTIONS

Please Note: For floor core placement, please reference base location information on page 38.

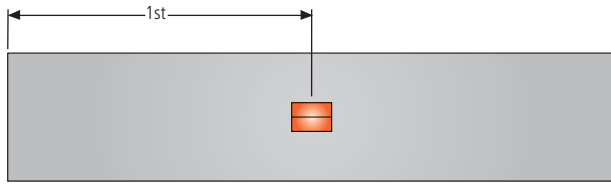

PL-1 or PX-1

PL-1 or PX-1	
Length	Center of Power Matrix
96	48
108	54
120	60
132	66
144	72
156	78
168	84
180	90
192	96
204	102
216	108
228	114
240	120

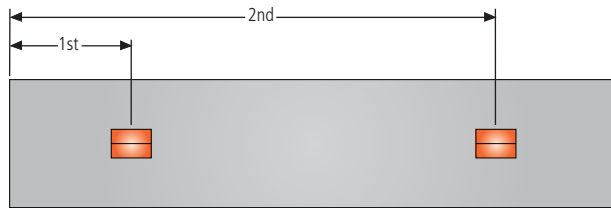

PL-2 or PX-2

PL-2 or PX-2		
Length	Center of 1st Power Matrix	Center of 2nd Power Matrix
144	45	99
156	47	109
168	50	118
180	53	127
192	48	114
204	51	153
216	54	162
228	57	171
240	60	180

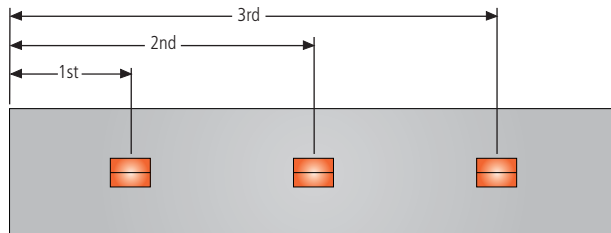

PL-3 or PX-3

PL-3 or PX-3			
Length	Center of 1st Power Matrix	Center of 2nd Power Matrix	Center of 3rd Power Matrix
216	54	108	162
228	57	114	171
240	60	120	180



RETRACTORS FOR POWER MATRIX

RETRACTORS

Cable retractors, for use with Power Matrix Small and Medium only, mount directly to the underside of conference room tables using the included mounting bracket. Loaded with 12' of cable that extends out 5' from the retractor. Retractors have a female input from the building infrastructure and a male connector on the output side. Not available on round tables.

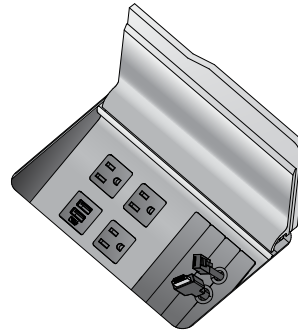

RETRACTOR AVAILABILITY ON ASCARI TABLES X = AVAILABLE AS STANDARD				
Length	PS-1/ PM-1	PS-2/ PM-2	PS-3/ PM-3	PS-4/ PM-4
96	X	X		
108	X	X		
120	X	X	X	
132		X		
144		X		X
156		X		X
168		X		X
180		X		X
192		X		X
204		X		X
216		X		X
228		X		X
240		X		X

Retractor Wire Management

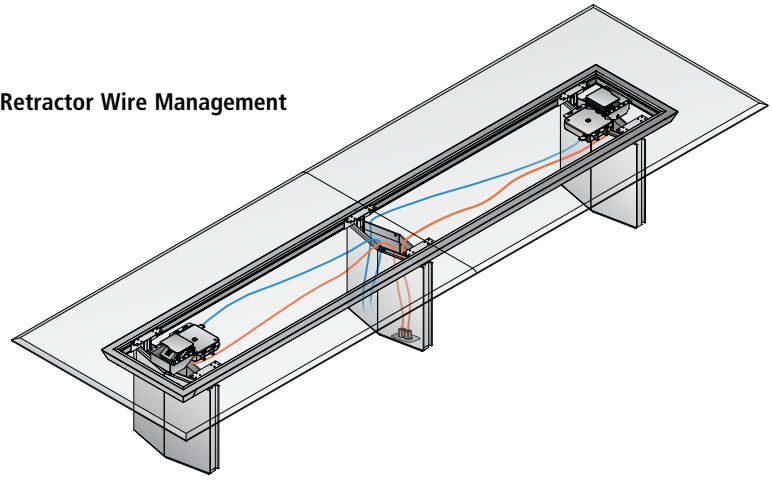

CAT6 Retractor

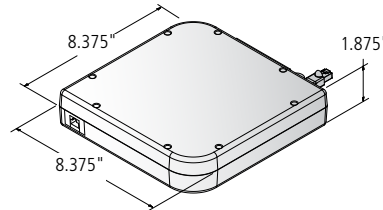

HDMI Retractor

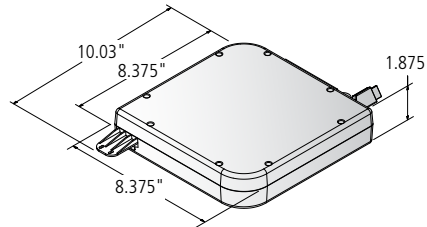

Data USB Retractor

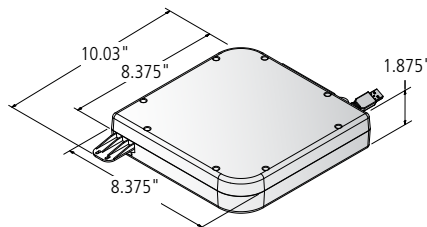



TABLE TOP POWER OPTION: WIRELESS POWER

WIRELESS POWER

Wireless Power Units are installed below the veneer, 10 inches inset from the edge of the table, to charge cell phones wirelessly. A small white LED indicator light is visible through the veneer to signal the location of each wireless charging unit. The quantity of the wireless power units per table is determined based on the size and shape of the table.

Wireless Power units are available to be specified along with other power options including: Power Matrix, Power Drawers, Low Profile Perimeter Power, and Power Rail.

When Wireless Power is specified, Ascari tables include a modular electrical system within the base of the table, allowing for a single point of connection to the building power. This connection can be either hardwired or corded (which requires a 20-amp power outlet in the floor monument), both of which are included with the table. See page 79 for more information on this electrical system.

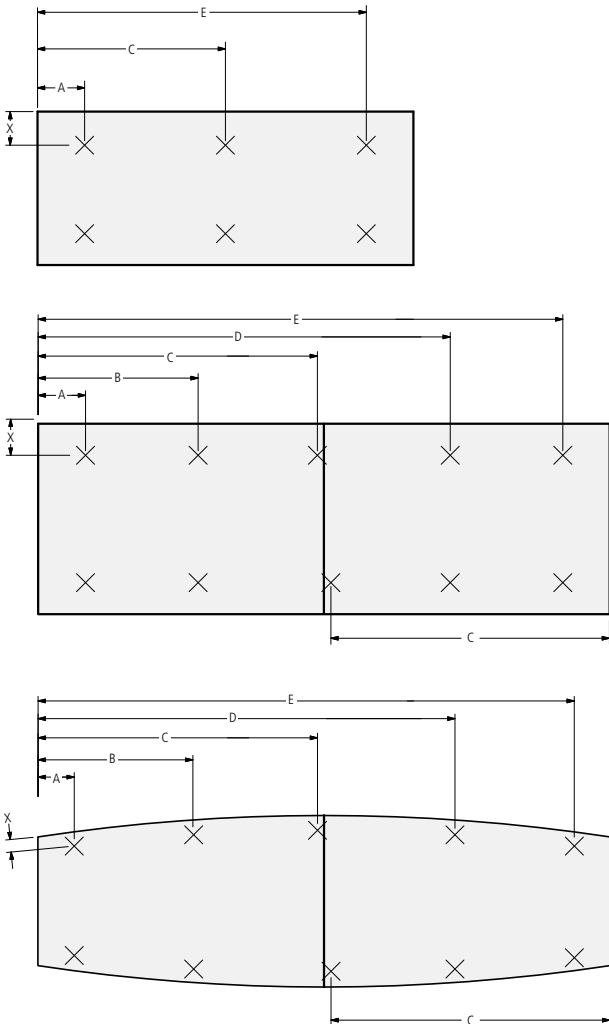
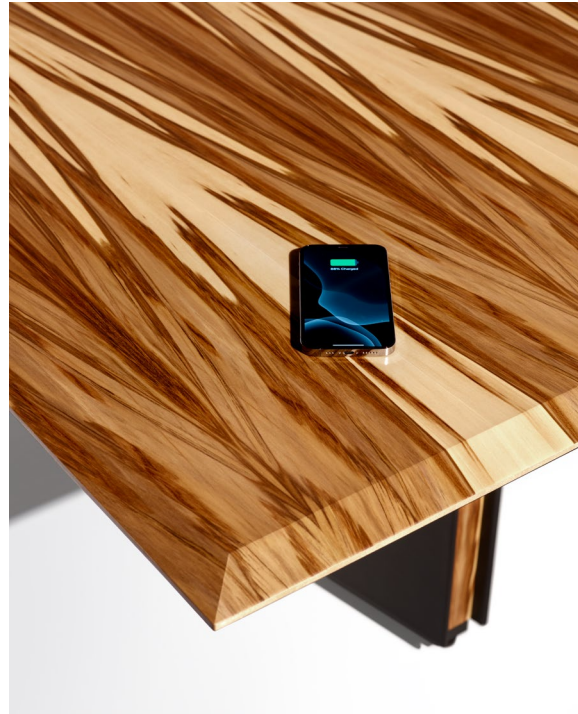

WIRELESS POWER LOCATIONS: RECTANGLE AND BOAT TABLES

Length	Rectangle and Boat					Rectangle		Boat
	A	B	C	D	E	Width	X	X
96	15	-	-	-	81	42	7.5	-
108	15	-	54	-	93	48	10	6
120*	15	-	60	-	105	54	10	6
132	15	-	61.5	-	117	60	10	6
144	15	51.5	-	92.5	129	72	10	6
156	15	55.5	-	100.5	141			
168	15	59.5	-	108.5	153			
180	15	50	85.5	130	165			
192	15	53	91.5	139	177			
204	15	56	97.5	148	189			
216	15	59	103.5	157	201			
228	15	62	109.5	166	213			
240	15	65	115.5	175	225			

*On tables with a chamfer edge, C=55.5

WIRELESS POWER LOCATION: ROUND TABLES

Diameter	Qty of Charging Units	Inches from Edge
42	2	6
48	2	6
54	4	6
60	4	6
72	4	6
84	4	6
96	4	6

*Charging Units will be across from each other



TABLE TOP POWER OPTION: POWER CAP

POWER

Where more power is desired and AV connectivity is not required, there are two standard configuration options available: one option with a simplex outlet and a USB-A+C charger or a two simplex outlet choice.

LOCATIONS

Power Cap or 2"-diameter grommet units can be specified at the center of round tables. Available only on 42" and 48" diameter round tables with Column Base.

Two Port:
For use with Round Tops

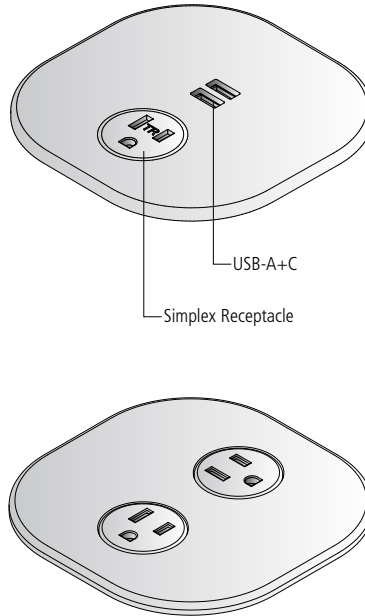

DESIGN

Power Cap's sleek profile and modest footprint features an aluminum body. Available in powder coat and polished chrome finish options.

PERFORMANCE

Intended for high use and quick access, Power Cap's low-profile aesthetic is non-lidded for ample space for plug-heads of all sizes.

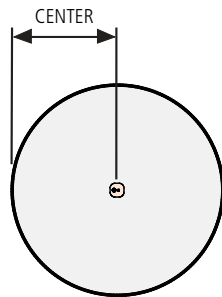

POWER CAP OR GROMMET LOCATIONS: ALL TABLE SIZES

Table Size	Base Style	Power Cap	CENTER
42 Dia.	Column Base	Two Port	21
48 Dia.	Column Base	Two Port	24



UNDER SURFACE POWER OPTION: POWER DRAWER

POWER DRAWERS

Discreetly incorporated into the subtop of the table, Power Drawers provide convenient yet covert access to power and AV connectivity (at the ends of the table) while leaving the table surface uninterrupted. The quantity of the Power Drawers per table is determined based on the size and shape of the table.

The drawer front features the same profile and finish as the table subtop, allowing it to blend seamlessly into the table design. The Power Drawer pulls out 10 inches beyond the edge of the table and closes on soft close slides. A small gap at the top of the drawer front allows the drawer to be closed while cables are connected to devices on the tabletop. The felt-lined drawers also provide storage for extra items.

The configuration inside the drawers on the long side of the tables is 2 simplex/ 2 USB A+C and 1 simplex/ 1 USB A+C/ 2 AAP plates on the ends of the table. The power can be removed from one drawer to create more space for storage.

When Power Drawers are specified, Ascari tables include a modular electrical system within the center base of the table, allowing for a single point of connection to the building power. This connection can be either hardwired or corded (which requires a 20-amp power outlet in the floor monument), both of which are included with the table. See page 79 for more information on this electrical system.

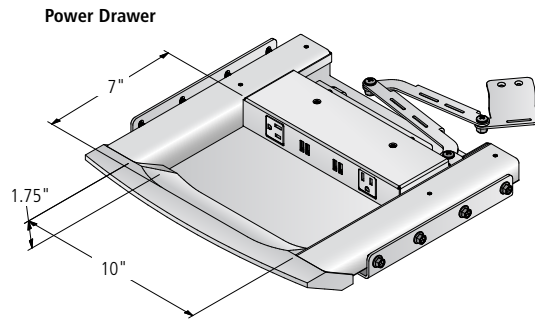

Power Drawer Dashboard - Long Sides of Table



Power Drawer Dashboard - Ends of Table

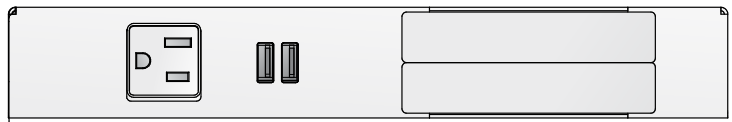

Wire Management Gap Between Table Top and Power Drawer (Chamfer Edge Shown)

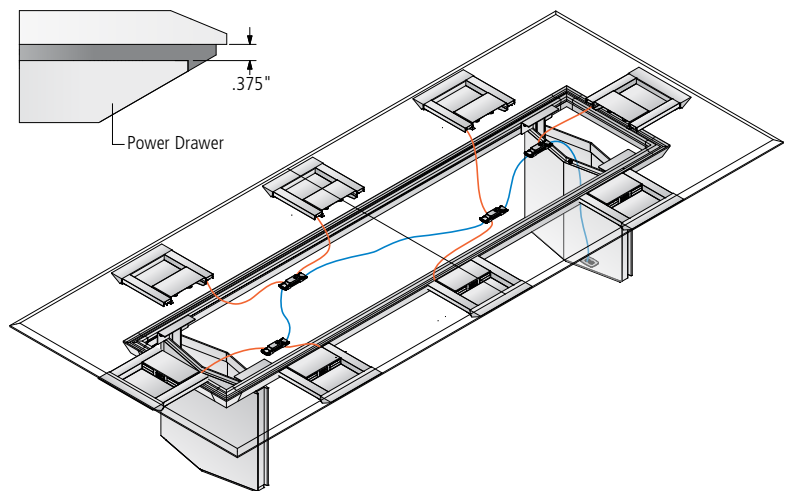

POWER DRAWERS PER TABLE SIZE

The quantity of Power Drawers per table is determined based on the size of the table.

TABLE SHAPE	TABLE SIZE	SEATING CAPACITY	POWER DRAWERS PER TABLE	POWER DRAWERS PER LONG SIDE	POWER DRAWERS PER END	TOTAL # OF RECEPTACLES	TOTAL # OF USB-A+C PORTS	TOTAL # OF AAP PLATES
Round	42 - 48	4	Not Available	0 per side	0 per end	0	0	0
Round	54	4	2	2 per side	0 per end	3	3	2
Round	60 - 96	5-10	4	4 per side	0 per end	7	7	2
Rectangle or Boat	96	8	4	1 per side	1 per end	6	6	4
Rectangle or Boat	108 - 132	10	6	2 per side	1 per end	10	10	4
Rectangle or Boat	144	12-14	8	3 per side	1 per end	14	14	4
Rectangle or Boat	156 - 168	14-16	8	3 per side	1 per end	14	14	4
Rectangle or Boat	180 - 204	16-18	10	4 per side	1 per end	18	18	4
Rectangle or Boat	216 - 240	18-20	10	4 per side	1 per end	18	18	4



UNDER SURFACE POWER OPTION: LOW PROFILE PERIMETER POWER

LOW PROFILE PERIMETER POWER

Discreetly incorporated into the subtop of the table, Low Profile Perimeter Power units provide convenient yet covert access to power and AV connectivity (at the ends of the table) while leaving the table surface uninterrupted. The quantity of the power units per table is determined based on the size and shape of the table. The configuration of the power units on the long side of the tables is 2 simplex/ 2 USB A+C and 1 simplex/ 1 USB A+C/ 2 AAP plates on the ends of the table.

The Low Profile Perimeter Power unit is set into the wood subtop in a metal housing that is finished in the same color choice as the metal beam of the table. If the housing color is Cloud or Foil, then the simplex color of the unit will be white. Any other finish will have black simplexes. The lighted option offers LED down lighting to illuminate the faceplate. The light can be turned off by an on/off switch.

When Low Profile Perimeter Power is specified, Ascari tables include a modular electrical system within the base of the table, allowing for a single point of connection to the building power. This connection can be either hardwired or corded (which requires a 20-amp power outlet in the floor monument), both of which are included with the table. See page 79 for more information on this electrical system.

Low Profile Perimeter Power Dashboard - Long Sides of Table

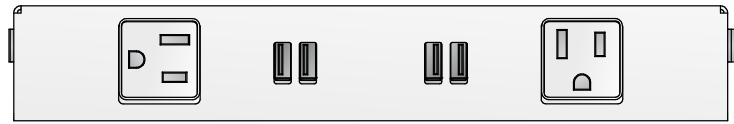

Low Profile Perimeter Power Dashboard - Ends of Table

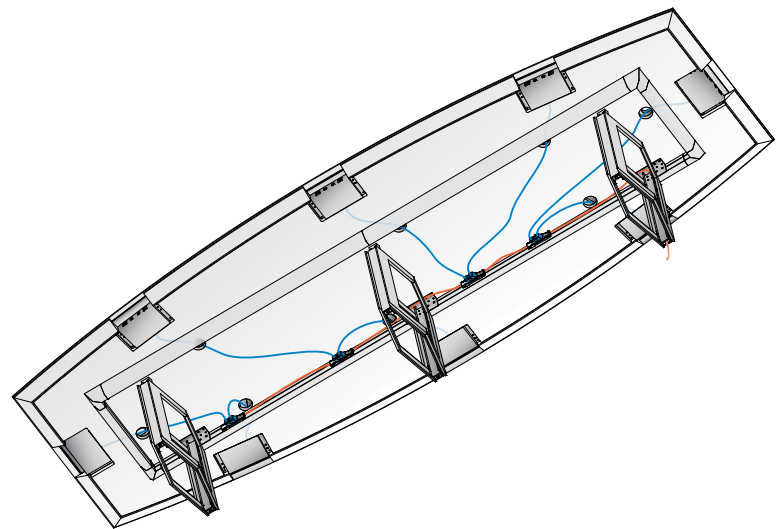
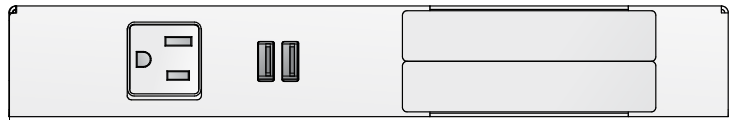

Lighted Option for Low Profile Perimeter Power



LOW PROFILE PERIMETER POWER UNITS PER TABLE SIZE

The quantity of Low Profile Perimeter Power units per table is determined based on the size of the table.

TABLE SHAPE	TABLE SIZE	SEATING CAPACITY	LOW PROFILE PERIMETER POWER PER TABLE	LOW PROFILE PERIMETER POWER PER LONG SIDE	LOW PROFILE PERIMETER POWER PER END	TOTAL # OF SIMPLEX	TOTAL # OF USB-A+C PORTS	TOTAL # OF AAP PLATES
Round	42-48	4	Not Available	0 per side	0 per end	0	0	0
Round	54	4	2	2 per side	0 per end	3	3	2
Round	60-96	5-10	4	4 per side	0 per end	7	7	2
Rectangle or Boat	96	8	4	1 per side	1 per end	6	6	4
Rectangle or Boat	108-132	10	6	2 per side	1 per end	10	10	4
Rectangle or Boat	144	12-14	8	3 per side	1 per end	14	14	4
Rectangle or Boat	156-168	14-16	8	3 per side	1 per end	14	14	4
Rectangle or Boat	180-204	16-18	10	4 per side	1 per end	18	18	4
Rectangle or Boat	216-240	18-20	10	4 per side	1 per end	18	18	4



UNDER SURFACE POWER OPTION: POWER RAIL

This low-profile option addresses the need for power & data connectivity just below the table top. This is an ideal choice for those who desire a visually uninterrupted table top and appreciate the inherent flexibility of the Power Rail to be removed at a later date as they transition to a truly wireless environment.

Held in place with screws, Power Rail units can be placed anywhere along the perimeter of the table. This flexible mounting design allows for additional units to be added as necessary, or to be removed when no longer needed.

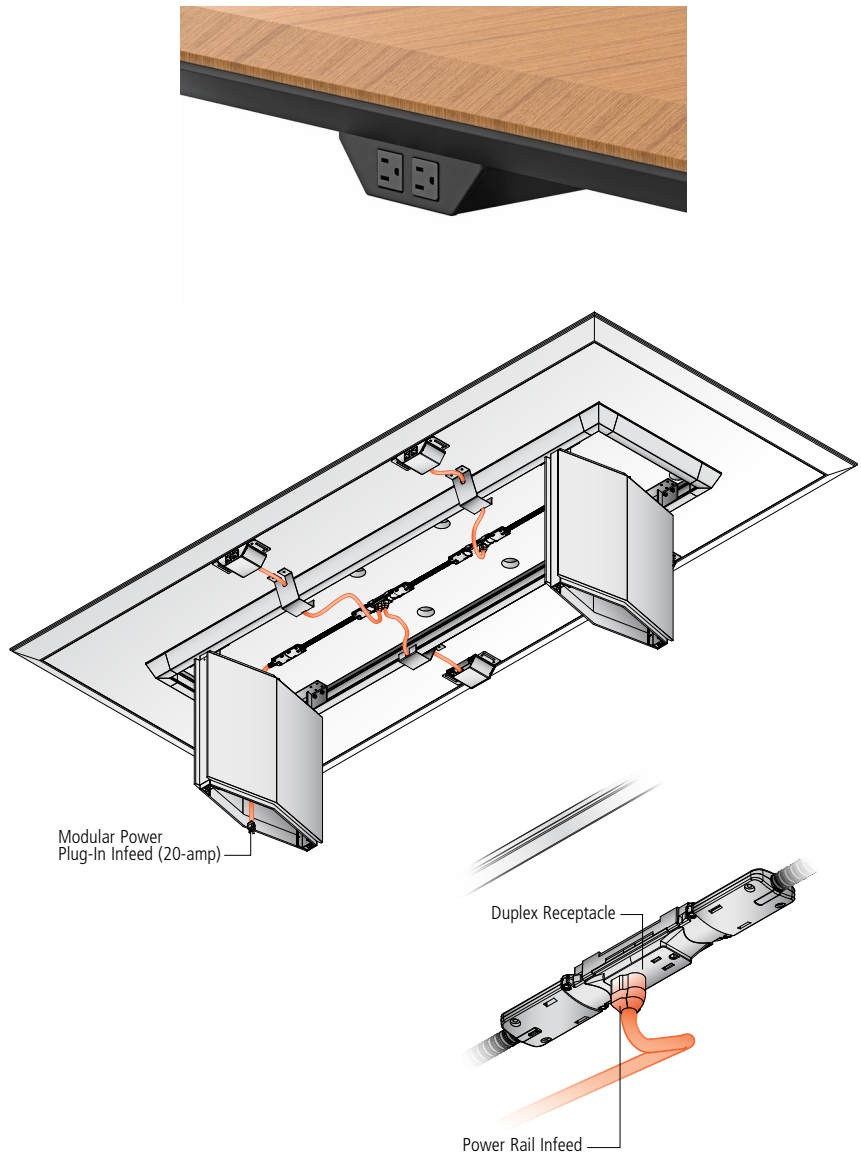

Power Rails are available in three configurations:

- Two simplex receptacles (UL Listed)
- One simplex receptacle and one powered USB-A+C connector (UL Listed)
- Two single space A/V faceplate designed for use with Extron Architectural Adaptor Plates (AAPs)

When Power Rails are specified on an Ascari table, a direct plug-in infeed or hardwired option is available. The direct plug-in infeed option has a single circuit electrical system and the hardwire option requires a two-circuit electrical system. Maximum of 12 Power Rails per table

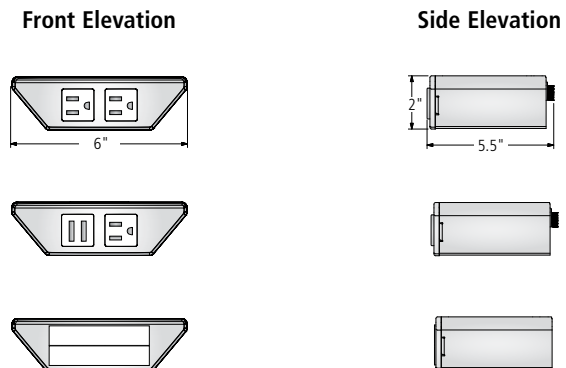



WIRE MANAGEMENT OPENINGS

WIRE MANAGEMENT

Wires run behind the metal reveal of the panel bases for wire management. They can be accessed by removing the wooden panels of the base.

There is a 2.5" space between the bottom of the Open Panel Base and the floor for wire management.

Closed Panel Base

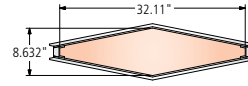
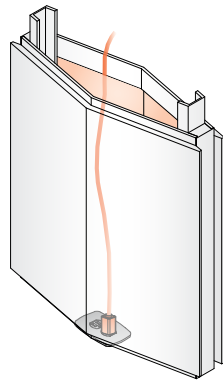

Rectangle & Boat - 72"-Wide Tops

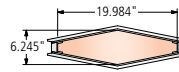

Rectangle & Boat - 60"-Wide Tops

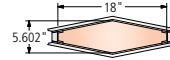

Rectangle & Boat - 54"-Wide Tops

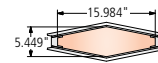

Rectangle - 42" & 48"-Wide Tops
Boat - 48" & 50"-Wide Tops

Open Panel Base

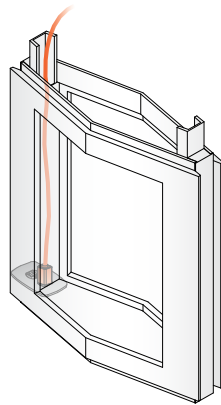

WIRE CHASE

The Wire Chase enclosure is a non-structural component that can be placed anywhere along the centerline of the table between two bases, providing great flexibility for locating it directly over a floor core or to be removed altogether if future cable needs change.

Wire Chase (Non-Structural)

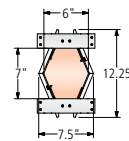
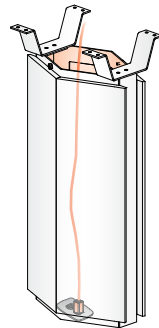



WIRE MANAGEMENT OPENINGS

Wires run behind the metal reveal of the panel bases for wire management. They can be accessed by removing the wooden panels of the base.

There is a 2.5" space between the bottom of the Open Panel X Base and the floor for wire management.

Closed Panel X Base

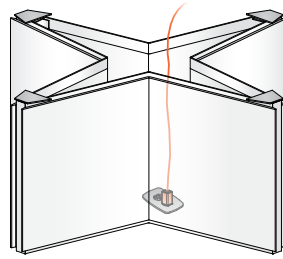

Open Panel X Base

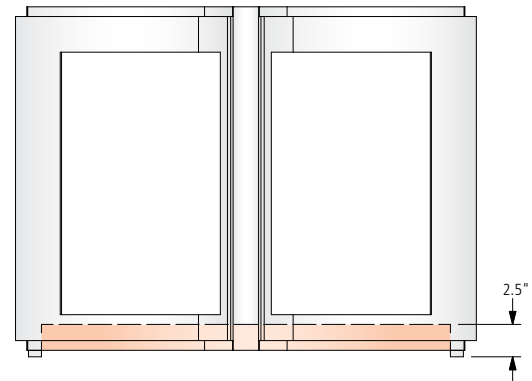
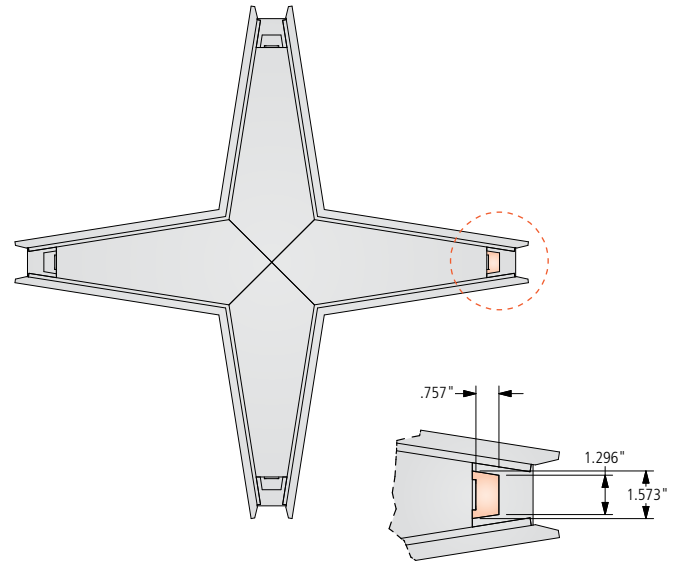
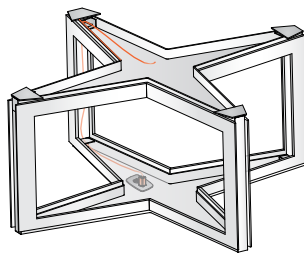

Height between the floor and the bottom of the Base Plate



WIRE MANAGEMENT OPENINGS

Island Base

Wires are easily contained within the island base and can be accessed by removing the wooden panels of the island base.

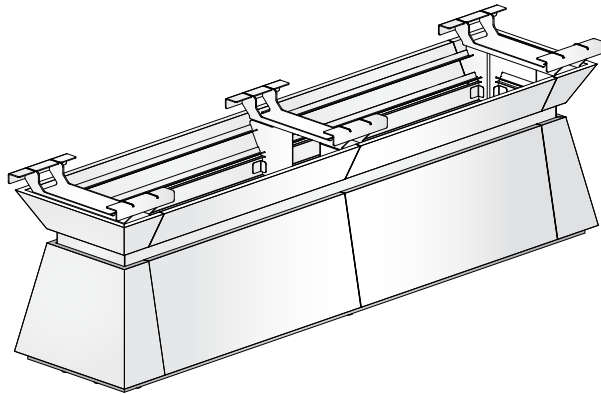

Top Width	A
42	9.5
48	9.5
54	11.5
60	13
72	25.5

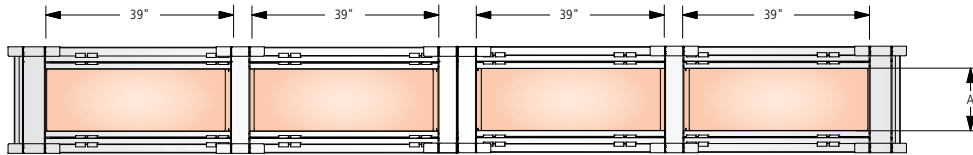

240" Long Tops

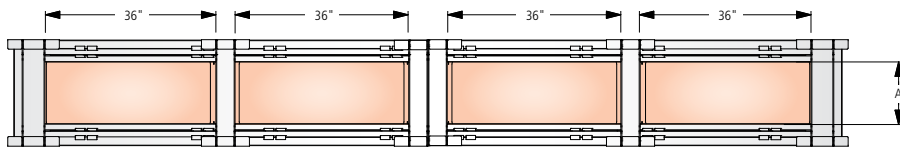

228" Long Tops

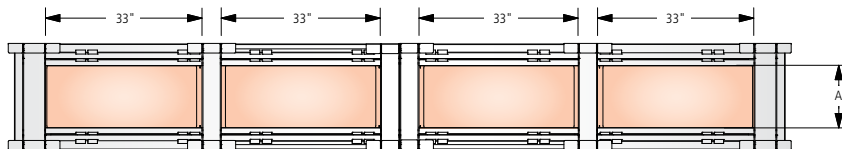

216" Long Tops

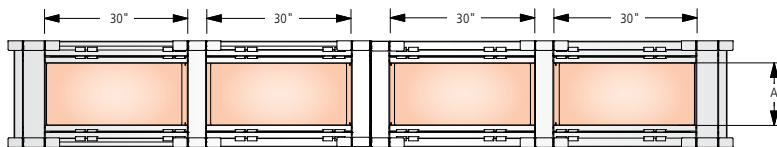

204" Long Tops

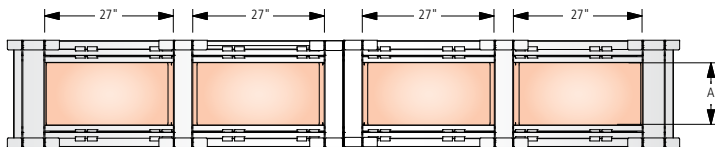

192" Long Tops

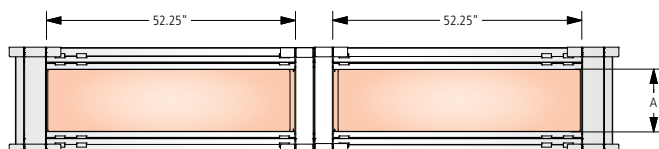

180" Long Tops



WIRE MANAGEMENT OPENINGS

Island Base

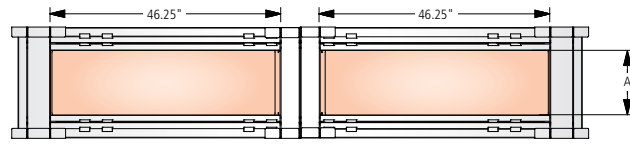

168" Long Tops

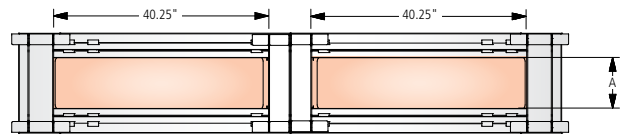

156" Long Tops

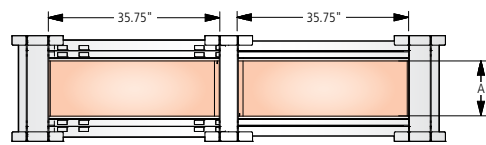

144" Long Tops

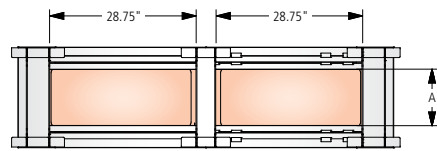

132" Long Tops

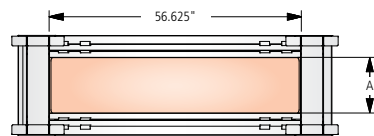

120" Long Tops

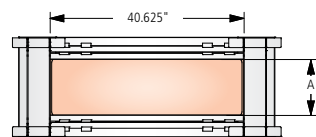

108" Long Tops

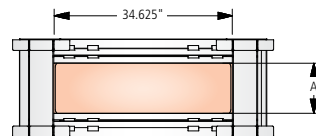

96" Long Tops



WIRE MANAGEMENT OPENINGS

Column Base with Wire Management Channel

A steel wire management channel, included with each Round Table with a Column Base when specified with a power cap, accommodates power and data cables. The wire management channel comes in the same finishes as the Column Base.

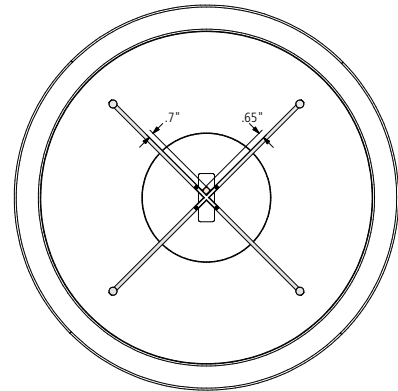
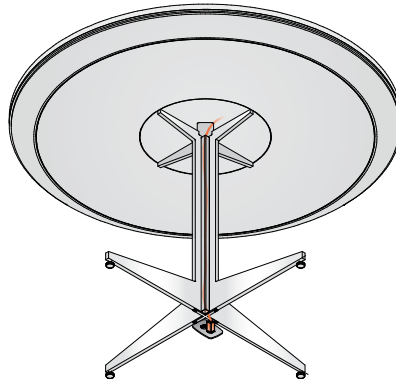



BASE DIMENSIONS

Closed Panel X Base

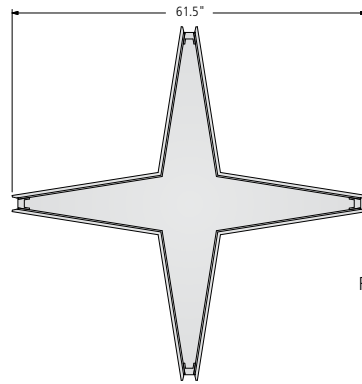
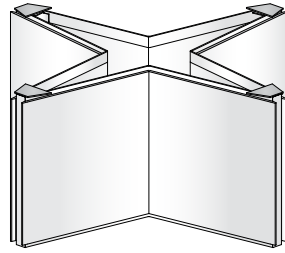

Round - 96"-Wide Tops

Open Panel X Base

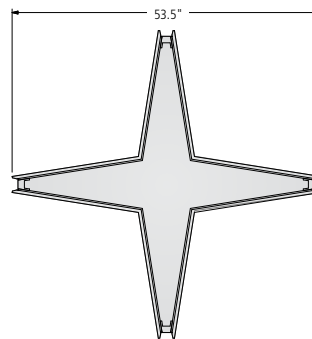
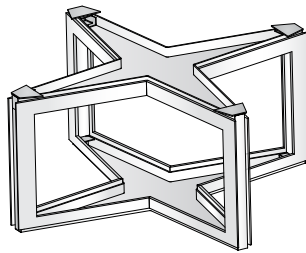

Round - 72" & 84"-Wide Tops

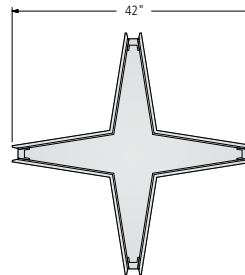

Round - 60"-Wide Tops

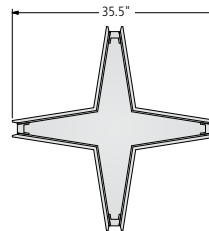

Round - 54"-Wide Tops

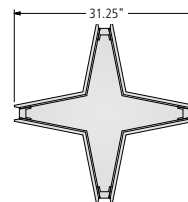

Round - 42" & 48"-Wide Tops



BASE DIMENSIONS

Closed Panel Base

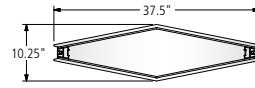
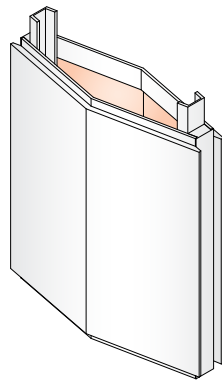

Rectangle & Boat - 72"-Wide Tops

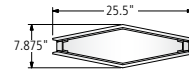

Rectangle & Boat - 60"-Wide Tops

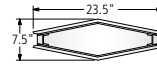

Rectangle & Boat - 54"-Wide Tops

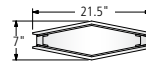

Rectangle - 42" & 48"-Wide Tops
Boat - 48" & 50"-Wide Tops

Open Panel Base

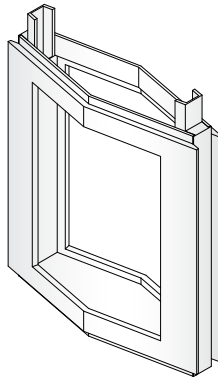



BASE DIMENSIONS

Island Base

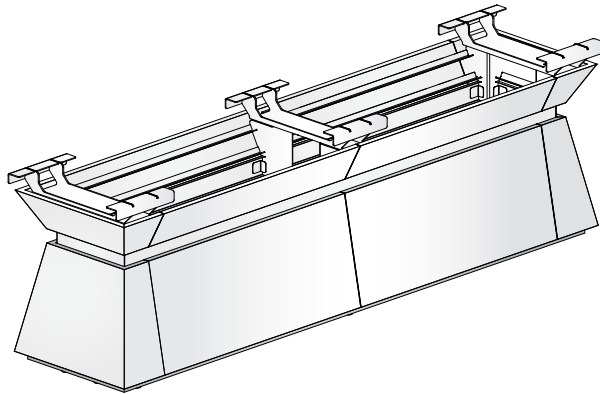

42"/48"-wide Tops

18.50"



54"-wide Tops

20.25"



60"-wide Tops

22.25"

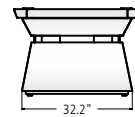

72"-wide Tops

32.2"

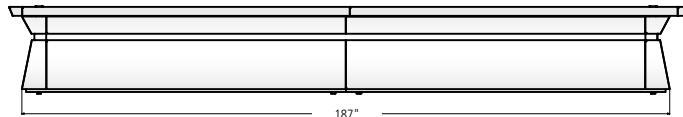

240" Long Tops

187"



228" Long Tops

175"



216" Long Tops

163"

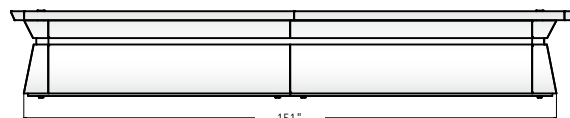

204" Long Tops

151"

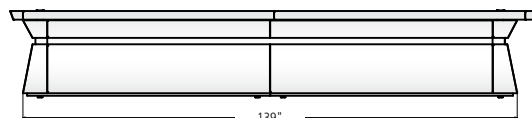

192" Long Tops

139"



180" Long Tops

127"



BASE DIMENSIONS

Island Base

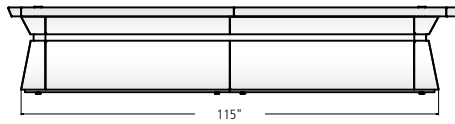

168" Long Tops

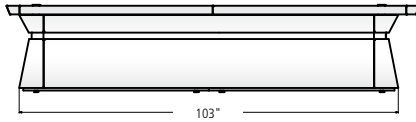

156" Long Tops

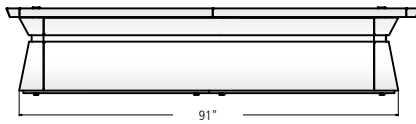

144" Long Tops

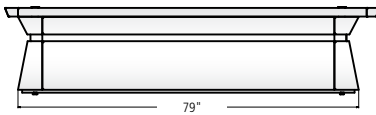

132" Long Tops

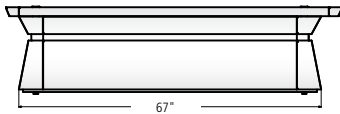

120" Long Tops

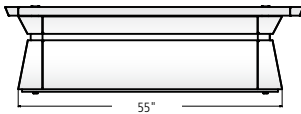

108" Long Tops

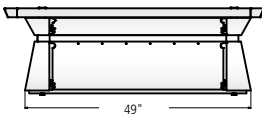

96" Long Tops



BASE LOCATIONS

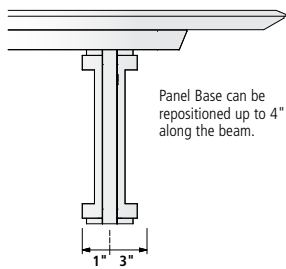
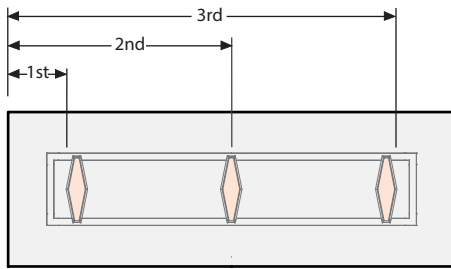

ALL PANEL BASES (ALL TABLE SHAPES)

Table Length	Center of 1st Base	Center of 2nd Base	Center of 3rd Base
96	24	72	-
108	24	84	-
120	24	96	-
132	24	108	-
144	24	120	-
156	24	78	132
168	24	84	144
180	24	90	156
192	24	96	168
204	24	102	180
216	24	108	192
228	24	114	204
240	24	120	216

*Panel Base will not fit over a floor core.

WIRE CHASE

Wire Chase (non-structural) is positioned along the length of the table and runs perpendicular to the panel bases to provide clearance for people's legs.

Table shown is 120" x 48"
Wire Chase is 12.5" x 7.5"

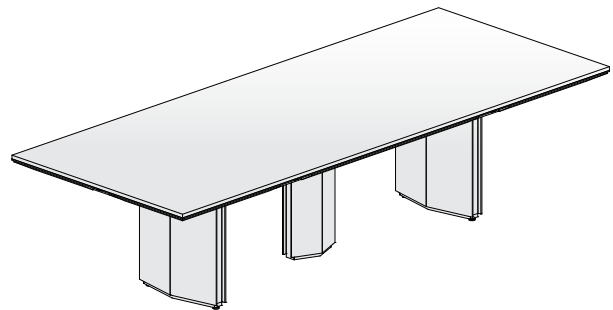



VENEER TOP WITH HARDWOOD EDGE



ROUND TOP

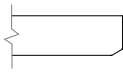

2" THICK EDGE

BASE KEY

POX	Painted Open Panel X Base
PCX	Painted Closed Panel X Base
VOX	Veneer Open Panel X Base
VCX	Veneer Closed Panel X Base
XC	Column Base

VENEER TOP WITH HARDWOOD EDGE

MODEL #	L x W	TOP SECTIONS	SUBTOP SECTIONS	-POX	-PCX	-VOX	-VCX	-XC
ACRO-42-V-SQ	42 x 42	1	1	8,026	7,423	8,321	7,650	4,197
ACRO-48-V-SQ	48 x 48	1	1	9,432	8,764	9,760	9,015	5,184
ACRO-54-V-SQ	54 x 54	1	1	11,083	10,344	11,445	10,622	-
ACRO-60-V-SQ	60 x 60	1	1	12,546	11,762	12,931	12,057	-
ACRO-72-V-SQ	72 x 72	2	2	15,247	14,452	15,637	14,751	-
ACRO-84-V-SQ	84 x 84	2	2	17,420	16,625	17,810	16,924	-
ACRO-96-V-SQ	96 x 96	2	2	19,928	19,133	20,318	19,432	-

MATERIAL SELECTIONS

	CODE	PRICE	NOTES
Base Reveal Finish Options:			
Powder Coat	-PBR	No Charge	
Veneer	-VBR	\$1,669	
Clear Anodized	-CABR	No Charge	
Polished Stainless	-APSBR	\$2,030	
Blackened Nickel	-ABNBR	\$2,030	
Chemetal	-CBR	\$2,030	
Satin Bronze Plating	-SBPBR	\$2,030	

OPTIONS	CODE	PRICE	NOTES
Power & Data Options:			
			See page 14 and 74-82
Polished Chrome Column Base Finish:	-PCB	\$2,783	
Wireless Charging (Table Top Power) Options:			
42"-48" Tables	-WCH	\$738	42"-48" include 2 Charging Units
54"-96" Tables	-WCH	\$1,474	54"-96" include 4 Charging Units

GENERAL INFORMATION

- Veneer on base panels is vertical
- Column base is metal. Select Powder Coat or Polished Chrome finish.
- Top material of column base includes a subtop
- Wireless charging can be specified with any other power option on the same table
- The wireless charging light is LED
- Wireless charging indicator light will always be on unless it is charging
- Power Drawers and Low Profile Perimeter Power units not available on 2" square profile tables
- If any finish other than Powder Coat is selected on the base reveal, the 3/4" above and below the base panels defaults to black if no other selection is made
- The reveal finish selection will include all interior surfaces on Open Panel bases
- Compact Power Matrix is the only Power Matrix option for Round tables
- Retractors are not available on Round tables

REQUIRED INFORMATION (ORDER CANNOT BE ENTERED WITHOUT THIS INFORMATION)

See appendix pages vi-vii for surface material options

- Choose Veneer Finish
- Choose Paint Finish, if painted base (-POX or -PCX) is specified
- Choose Chemetal Finish, if specified as a reveal finish (-CBR)



VENEER TOP WITH HARDWOOD EDGE



ROUND TOP

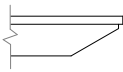

SQUARE EDGE

BASE KEY

POX	Painted Open Panel X Base
PCX	Painted Closed Panel X Base
VOX	Veneer Open Panel X Base
VCX	Veneer Closed Panel X Base
XC	Column Base

VENEER TOP WITH HARDWOOD EDGE

MODEL #	L x W	TOP SECTIONS	SUBTOP SECTIONS	-POX	-PCX	-VOX	-VCX	-XC
ACRO-42-V-SQC	42 x 42	1	1	8,026	7,423	8,321	7,650	4,197
ACRO-48-V-SQC	48 x 48	1	1	9,432	8,764	9,760	9,015	5,184
ACRO-54-V-SQC	54 x 54	1	1	11,083	10,344	11,445	10,622	-
ACRO-60-V-SQC	60 x 60	1	1	12,546	11,762	12,931	12,057	-
ACRO-72-V-SQC	72 x 72	2	2	15,247	14,452	15,637	14,751	-
ACRO-84-V-SQC	84 x 84	2	2	17,420	16,625	17,810	16,924	-
ACRO-96-V-SQC	96 x 96	2	2	19,928	19,133	20,318	19,432	-

MATERIAL SELECTIONS

	CODE	PRICE	NOTES
Subtop Finish Options:			
Paint	-PAP	No Charge	
Veneer	-VAP	No Charge	
Base Reveal Finish Options:			
Powder Coat	-PBR	No Charge	
Veneer	-VBR	\$1,669	
Clear Anodized	-CABR	No Charge	
Polished Stainless	-APSB	\$2,030	
Blackened Nickel	-ABNBR	\$2,030	
Chemetal	-CBR	\$2,030	
Satin Bronze Plating	-SBPBR	\$2,030	

OPTIONS

	CODE	PRICE	
Subtop Metal Detail Options:			
Powder Coat	-MTPB	\$952	42"-60" Tables \$1,065
Polished Stainless	-MTAPS	\$1,267	72"-96" Tables \$1,505
Clear Anodized	-MTCA	\$952	72"-96" Tables \$1,065
Power & Data Options: See page 14 and 74-82			
Polished Chrome Column Base Finish: -PCB \$2,783			
Power Drawer Options:			
54" Tables	-PD2C	\$3,242	Includes 2 Power Drawers
60"-96" Tables	-PD4C	\$6,481	Includes 4 Power Drawers
Remove Power from (1) Power Drawer	-PD0	Deduct \$798	Adds 10" of storage space
Low Profile Perimeter Power Options:			
54" Tables	-LPP2C	\$2,089	Includes 2 Low Profile Perimeter Power Units
60"-96" Tables	-LPP4C	\$4,177	Includes 4 Low Profile Perimeter Power Units
Lighted Low Profile Perimeter Power Options: Provides LED downlighting to illuminate faceplate			
54" Tables	-LTTP2C	\$3,625	Includes 2 Low Profile Perimeter Power Units with LED lighted option
60"-96" Tables	-LTTP4C	\$5,713	Includes 4 Low Profile Perimeter Power Units with LED lighted option
Wireless Charging (Table Top Power) Options:			
42"-48" Tables	-WCH	\$738	42"-48" include 2 Charging Units
54"-96" Tables	-WCH	\$1,474	54"-96" include 4 Charging Units
Field-Wired: -FW No Charge			

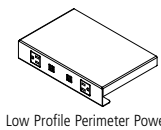
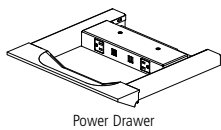
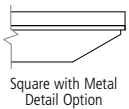



VENEER TOP

GENERAL INFORMATION

- Veneer on base panels is vertical
- Column base is metal. Select Powder Coat or Polished Chrome finish.
- Top material of column base includes a subtop
- Subtop is set back 1/4" from edge of the table top
- Subtop is only available in Paint finish (-PAP) option when Paldeo veneer finish is selected for the top
- Wireless charging can be specified with any other power option on the same table
- Faceplate of the Low Profile Perimeter Power will default to beam color unless otherwise specified
- Metal detail option can be any metal finish (except Chemetal)
- Power Drawer and Low Profile Perimeter Power locations are set within the subtop and are in pre-determined quantities based on the size of the table
- Power Drawers and Perimeter Power Units have (2) Simplex / (2) USB-A+C Chargers on the table. Each table has one drawer or perimeter power units with the configuration of (1) Simplex / (1) USB-A+C Charger / 2 Extron Architectural Adaptor Plates (AAP) plates.
- If any finish other than Powder Coat is selected on the base reveal, the 3/4" above and below the base panels defaults to black if no other selection is made
- Power Drawer face is hardwood
- Power Drawer bottom defaults to Knoll Felt - Pewter
- Power Drawer has a space between the drawer and the bottom of the table for wire access/egress when the drawer is closed
- The reveal finish selection will include all interior surfaces on Open Panel bases
- Compact Power Matrix is the only Power Matrix option for Round tables
- Retractors are not available on Round tables
- Subtop has a hardwood rail

REQUIRED INFORMATION (ORDER CANNOT BE ENTERED WITHOUT THIS INFORMATION)

See appendix pages vi-vii for surface material options.

- Choose Veneer Finish
- Choose Paint Finish, if painted base (-POX or -PCX) is specified, or if painted sub-top (-PAP) is specified. If multiple components are specified as painted, they will all be the same finish.
- Choose Chemetal Finish, if specified as a reveal finish (-CBR)



LAMINATE / FENIX TOPS



ROUND TOP

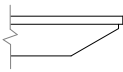

SQUARE EDGE

BASE KEY

POX	Painted Open Panel X Base
PCX	Painted Closed Panel X Base
VOX	Veneer Open Panel X Base
VCX	Veneer Closed Panel X Base
XC	Column Base

LAMINATE TOP WITH HARDWOOD EDGE

MODEL #	L x W	TOP SECTIONS	SUBTOP SECTIONS	-POX	-PCX	-VOX	-VCX	-XC
ACRO-42-P-SQC	42 x 42	1	1	7,746	7,164	8,030	7,383	4,051
ACRO-48-P-SQC	48 x 48	1	1	9,102	8,458	9,419	8,700	5,003
ACRO-54-P-SQC	54 x 54	1	1	10,696	9,982	11,045	10,251	-
ACRO-60-P-SQC	60 x 60	1	1	12,107	11,351	12,479	11,636	-
ACRO-72-P-SQC	72 x 72	2	2	14,714	13,947	15,090	14,235	-
ACRO-84-P-SQC	84 x 84	2	2	16,811	16,044	17,187	16,332	-
ACRO-96-P-SQC	96 x 96	2	2	19,231	18,464	19,607	18,752	-

LAMINATE TOP WITH ABS EDGE

MODEL #	L x W	TOP SECTIONS	SUBTOP SECTIONS	-POX	-PCX	-VOX	-VCX	-XC
ACRO-42-PE-SQC	42 x 42	1	1	7,425	6,867	7,697	7,077	3,883
ACRO-48-PE-SQC	48 x 48	1	1	8,725	8,107	9,028	8,339	4,796
ACRO-54-PE-SQC	54 x 54	1	1	10,252	9,569	10,587	9,826	-
ACRO-60-PE-SQC	60 x 60	1	1	11,606	10,880	11,962	11,153	-
ACRO-72-PE-SQC	72 x 72	2	2	14,104	13,369	14,465	13,645	-
ACRO-84-PE-SQC	84 x 84	2	2	16,114	15,379	16,475	15,655	-
ACRO-96-PE-SQC	96 x 96	2	2	18,434	17,699	18,795	17,975	-

FENIX TOP WITH HARDWOOD EDGE

MODEL #	L x W	TOP SECTIONS	SUBTOP SECTIONS	-POX	-PCX	-VOX	-VCX	-XC
ACRO-42-X-SQC	42 x 42	1	1	8,508	7,869	8,821	8,109	4,449
ACRO-48-X-SQC	48 x 48	1	1	9,998	9,290	10,346	9,556	5,496
ACRO-54-X-SQC	54 x 54	1	1	11,748	10,965	12,132	11,260	-
ACRO-60-X-SQC	60 x 60	1	1	13,299	12,468	13,707	12,781	-
ACRO-72-X-SQC	72 x 72	2	2	16,162	15,320	16,576	15,637	-
ACRO-84-X-SQC	84 x 84	2	2	18,466	17,623	18,879	17,940	-
ACRO-96-X-SQC	96 x 96	2	2	21,124	20,281	21,538	20,598	-

FENIX TOP WITH EDGE BAND

MODEL #	L x W	TOP SECTIONS	SUBTOP SECTIONS	-POX	-PCX	-VOX	-VCX	-XC
ACRO-42-XE-SQC	42 x 42	1	1	8,348	7,720	8,654	7,956	4,365
ACRO-48-XE-SQC	48 x 48	1	1	9,810	9,115	10,151	9,376	5,392
ACRO-54-XE-SQC	54 x 54	1	1	11,527	10,758	11,903	11,047	-
ACRO-60-XE-SQC	60 x 60	1	1	13,048	12,233	13,449	12,540	-
ACRO-72-XE-SQC	72 x 72	2	2	15,857	15,031	16,263	15,342	-
ACRO-84-XE-SQC	84 x 84	2	2	18,117	17,290	18,523	17,601	-
ACRO-96-XE-SQC	96 x 96	2	2	20,726	19,899	21,131	20,210	-

MATERIAL SELECTIONS

	CODE	PRICE	NOTES
Subtop Finish Options:			
Paint	-PAP	No Charge	
Veneer	-VAP	No Charge	
Base Reveal Finish Options:			
Powder Coat	-PBR	No Charge	
Veneer	-VBR	\$1,669	
Clear Anodized	-CABR	No Charge	
Polished Stainless	-APSB	\$2,030	
Blackened Nickel	-ABNBR	\$2,030	
Chemetal	-CBR	\$2,030	
Satin Bronze Plating	-SBPBR	\$2,030	



LAMINATE / FENIX TOPS

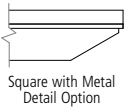

Square with Metal Detail Option

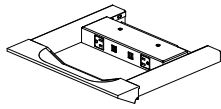

Power Drawer

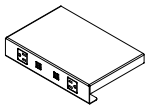

Low Profile Perimeter Power

OPTIONS	CODE	PRICE	
Subtop Metal Detail Options:			
		42"-60" Tables	72"-96" Tables
Powder Coat	-MTPB	\$952	\$1,065
Polished Stainless	-MTAPS	\$1,267	\$1,505
Clear Anodized	-MTCA	\$952	\$1,065
Power & Data Options:		See page 14 and 74-82	
Polished Chrome Column Base Finish:	-PCB	\$2,783	
Power Drawer Options:			
54" Tables	-PD2C	\$3,242	Includes 2 Power Drawers
60"-96" Tables	-PD4C	\$6,481	Includes 4 Power Drawers
Remove Power from (1) Power Drawer	-PD0	Deduct \$798	Adds 10" of storage space
Low Profile Perimeter Power Options:			
54" Tables	-LPP2C	\$2,089	Includes 2 Low Profile Perimeter Power Units
60"-96" Tables	-LPP4C	\$4,177	Includes 4 Low Profile Perimeter Power Units
Lighted Low Profile Perimeter Power Options:			
			Provides LED downlighting to illuminate faceplate
54" Tables	-LTPP2C	\$3,625	Includes 2 Low Profile Perimeter Power Units with LED lighted option
60"-96" Tables	-LTPP4C	\$5,713	Includes 4 Low Profile Perimeter Power Units with LED lighted option
Field-Wired:	-FW	No Charge	

GENERAL INFORMATION

- Veneer on base panels is vertical
- Column base is metal. Select Powder Coat or Polished Chrome finish.
- Top material of column base includes a subtop
- Subtop is set back 1/4" from edge of the table top
- Wireless charging can be specified with any other power option on the same table
- Faceplate of the Low Profile Perimeter Power will default to beam color unless otherwise specified
- Metal detail option can be any metal finish (except Chemetal)
- Power Drawer and Low Profile Perimeter Power locations are set within the subtop and are in pre-determined quantities based on the size of the table
- Power Drawers and Perimeter Power Units have (2) Simplex / (2) USB-A+C Chargers on the table. Each table has one drawer or perimeter power units with the configuration of (1) Simplex / (1) USB-A+C Charger / 2 Extron Architectural Adaptor Plates (AAP) plates.
- If any finish other than Powder Coat is selected on the base reveal, the 3/4" above and below the base panels defaults to black if no other selection is made
- Power Drawer face is hardwood
- Power Drawer bottom defaults to Knoll Felt - Pewter
- Power Drawer has a space between the drawer and the bottom of the table for wire access/egress when the drawer is closed
- The reveal finish selection will include all interior surfaces on Open Panel bases
- Compact Power Matrix is the only Power Matrix option for Round tables
- Retractors are not available on Round tables
- Subtop has a hardwood rail

REQUIRED INFORMATION (ORDER CANNOT BE ENTERED WITHOUT THIS INFORMATION)

See appendix pages vi-vii for surface material options.

LAMINATE TOPS

- Choose Laminate Finish
- Choose Veneer Finish, if Hardwood Edge specified
- Choose ABS Finish, if ABS Edge specified
- Choose Paint Finish, if painted base (-POX or -PCX) is specified, or if painted sub-top (-PAP) is specified. If multiple components are specified as painted, they will all be the same finish.
- Choose Chemetal Finish, if specified as a reveal finish (-CBR)

FENIX TOPS

- Choose Fenix Finish
- Choose Veneer Finish, if Hardwood Edge specified
- Choose 1mm Edgeband Finish, if 1mm Edgeband specified
- Choose Paint Finish, if painted base (-POX or -PCX) is specified, or if painted sub-top (-PAP) is specified. If multiple components are specified as painted, they will all be the same finish.
- Choose Chemetal Finish, if specified as a reveal finish (-CBR)



GLASS / STONE TOPS



ROUND TOP

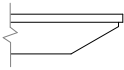

GLASS SQUARE EDGE

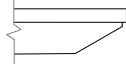

STONE SQUARE EDGE

BASE KEY

- POX Painted Open Panel X Base
- PCX Painted Closed Panel X Base
- VOX Veneer Open Panel X Base
- VCX Veneer Closed Panel X Base
- XC Column Base

GLASS TOP

MODEL #	L x W	TOP SECTIONS	SUBTOP SECTIONS	-POX	-PCX	-VOX	-VCX	-XC
ACRO-42-G-SQC	42 x 42	1	1	11,036	10,207	11,442	10,519	5,771
ACRO-48-G-SQC	48 x 48	1	1	12,969	12,051	13,420	12,396	7,128
ACRO-54-G-SQC	54 x 54	1	1	15,240	14,223	15,737	14,606	-
ACRO-60-G-SQC	60 x 60	1	1	17,251	16,173	17,781	16,579	-
ACRO-72-G-SQC	72 x 72	2	2	20,965	19,872	21,501	20,283	-
ACRO-84-G-SQC	84 x 84	2	2	23,953	22,860	24,489	23,271	-
ACRO-96-G-SQC	96 x 96	2	2	27,401	26,308	27,938	26,719	-

STONE TOP

MODEL #	L x W	TOP SECTIONS	SUBTOP SECTIONS	-POX	-PCX	-VOX	-VCX	-XC
ACRO-42-S-SQC	42 x 42	1	1	14,540	13,448	15,075	13,859	7,604
ACRO-48-S-SQC	48 x 48	1	1	17,088	15,877	17,682	16,332	9,392
ACRO-54-S-SQC	54 x 54	1	1	20,078	18,740	20,734	19,243	-
ACRO-60-S-SQC	60 x 60	1	1	22,729	21,309	23,426	21,843	-
ACRO-72-S-SQC	72 x 72	2	2	27,622	26,182	28,328	26,723	-
ACRO-84-S-SQC	84 x 84	2	2	31,559	30,118	32,265	30,660	-
ACRO-96-S-SQC	96 x 96	2	2	36,102	34,662	36,809	35,204	-

MATERIAL SELECTIONS

CODE

PRICE

NOTES

Subtop Finish Options:

Paint	-PAP	No Charge
Veneer	-VAP	No Charge

Satin Glass Option:

42"-60" Tables	-FSG	\$365	Available on Glass tables only
72"-96" Tables	-FSG	\$633	Available on Glass tables only

Base Reveal Finish Options:

Powder Coat	-PBR	No Charge
Veneer	-VBR	\$1,669
Clear Anodized	-CABR	No Charge
Polished Stainless	-APSBR	\$2,030
Blackened Nickel	-ABNBR	\$2,030
Chemetal	-CBR	\$2,030
Satin Bronze Plating	-SBPBR	\$2,030



GLASS / STONE TOPS

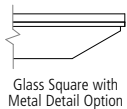

Glass Square with Metal Detail Option

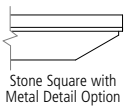

Stone Square with Metal Detail Option

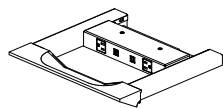

Power Drawer

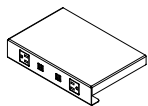

Low Profile Perimeter Power

OPTIONS	CODE	PRICE	
Subtop Metal Detail Options:			
Powder Coat	-MTPB	42"-60" Tables	72"-96" Tables
Polished Stainless	-MTAPS	\$952	\$1,065
Clear Anodized	-MTCA	\$1,267	\$1,505
		\$952	\$1,065
Power & Data Options:		See page 14 and 74-82	
Polished Chrome Column Base Finish:		-PCB	\$2,783
Power Drawer Options:			
54" Tables	-PD2C	\$3,242	Includes 2 Power Drawers
60"-96" Tables	-PD4C	\$6,481	Includes 4 Power Drawers
Remove Power from (1) Power Drawer	-PDO	Deduct \$798	Adds 10" of storage space
Low Profile Perimeter Power Options:			
54" Tables	-LPP2C	\$2,089	Includes 2 Low Profile Perimeter Power Units
60"-96" Tables	-LPP4C	\$4,177	Includes 4 Low Profile Perimeter Power Units
Lighted Low Profile Perimeter Power Options:			
		Provides LED downlighting to illuminate faceplate	
54" Tables	-LTPP2C	\$3,625	Includes 2 Low Profile Perimeter Power Units with LED lighted option
60"-96" Tables	-LTTP4C	\$5,713	Includes 4 Low Profile Perimeter Power Units with LED lighted option
Field-Wired:		-FW	No Charge

GENERAL INFORMATION

- Veneer on base panels is vertical
- Column base is metal. Select Powder Coat or Polished Chrome finish.
- Top material of column base includes a subtop
- Subtop is set back 1/4" from edge of the table top
- Wireless charging can be specified with any other power option on the same table
- Faceplate of the Low Profile Perimeter Power will default to beam color unless otherwise specified
- Metal detail option can be any metal finish (except Chemetal)
- Power Drawer and Low Profile Perimeter Power locations are set within the subtop and are in pre-determined quantities based on the size of the table
- Power Drawers and Perimeter Power Units have (2) Simplex / (2) USB-A+C Chargers on the table. Each table has one drawer or perimeter power units with the configuration of (1) Simplex / (1) USB-A+C Charger / 2 Extron Architectural Adaptor Plates (AAP) plates.
- If any finish other than Powder Coat is selected on the base reveal, the 3/4" above and below the base panels defaults to black if no other selection is made
- Power Drawer face is hardwood
- Power Drawer bottom defaults to Knoll Felt - Pewter
- Power Drawer has a space between the drawer and the bottom of the table for wire access/egress when the drawer is closed
- The reveal finish selection will include all interior surfaces on Open Panel bases
- Compact Power Matrix is the only Power Matrix option for Round tables
- Retractors are not available on Round tables
- Subtop has a hardwood rail
- Glass sections noted are for tables without power units. When power units are specified in the table, the glass sections are determined by the size of the power unit, quantity and location.

REQUIRED INFORMATION (ORDER CANNOT BE ENTERED WITHOUT THIS INFORMATION)

See appendix pages vi-vii for surface material options.

GLASS TOP

- Choose Glass Finish
- Choose Veneer Finish, if Veneer base (-VOX or -VCX) is specified, if Veneer sub-top (-VAP) is specified, or if Veneer is selected for Base Reveal (-VBR). If multiple components are specified as Veneer, they will all be the same finish.
- Choose Paint Finish, if painted base (-POX or -PCX) is specified, or if painted sub-top (-PAP) is specified. If multiple components are specified as painted, they will all be the same finish.
- Choose Chemetal Finish, if specified as a reveal finish (-CBR)

STONE TOP

- Choose Stone Finish
- Choose Veneer Finish, if Veneer base (-VOX or -VCX) is specified, if Veneer sub-top (-VAP) is specified, or if Veneer is selected for Base Reveal (-VBR). If multiple components are specified as Veneer, they will all be the same finish.
- Choose Paint Finish, if painted base (-POX or -PCX) is specified, or if painted sub-top (-PAP) is specified. If multiple components are specified as painted, they will all be the same finish.
- Choose Chemetal Finish, if specified as a reveal finish (-CBR)



VENEER TOP WITH HARDWOOD EDGE

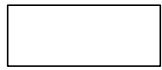

RECTANGLE TOP

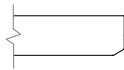

2" THICK EDGE

BASE KEY

POP	Painted Open Panel	VOP	Veneer Open Panel
PCP	Painted Closed Panel	VCP	Veneer Closed Panel
PVN	Painted Island	VVN	Veneer Island

VENEER TOP WITH HARDWOOD EDGE

MODEL #	L x W	TOP SECTIONS	SUBTOP SECTIONS	-POP	-PCP	-PVN	-VOP	-VCP	-VVN
ACRT-9642-V-SQ	96 x 42	1	1	11,745	11,223	13,538	12,160	11,526	14,000
ACRT-9648-V-SQ	96 x 48	1	1	12,709	12,169	14,564	13,139	12,483	15,041
ACRT-10842-V-SQ	108 x 42	1	1	12,896	12,346	14,789	13,335	12,666	15,276
ACRT-10848-V-SQ	108 x 48	1	1	14,005	13,436	15,964	14,459	13,767	16,468
ACRT-10854-V-SQ	108 x 54	1	1	15,322	14,727	17,367	15,796	15,072	17,893
ACRT-12042-V-SQ	120 x 42	1	1	14,101	13,521	16,093	14,563	13,858	16,606
ACRT-12048-V-SQ	120 x 48	1	1	15,364	14,764	17,425	15,841	15,112	17,956
ACRT-12054-V-SQ	120 x 54	1	1	16,858	16,232	19,011	17,357	16,595	19,565
ACRT-13248-V-SQ	132 x 48	2	2	16,650	16,026	18,798	17,148	16,389	19,350
ACRT-13254-V-SQ	132 x 54	2	2	18,320	17,668	20,563	18,840	18,047	21,140
ACRT-14448-V-SQ	144 x 48	2	2	17,990	17,341	20,223	18,508	17,718	20,798
ACRT-14454-V-SQ	144 x 54	2	2	19,843	19,165	22,176	20,384	19,559	22,776
ACRT-14460-V-SQ	144 x 60	2	2	22,010	21,295	24,466	22,579	21,710	25,098
ACRT-15648-V-SQ	156 x 48	2	2	22,449	21,465	21,110	23,233	22,037	21,691
ACRT-15654-V-SQ	156 x 54	2	2	24,601	23,573	23,203	25,420	24,171	23,809
ACRT-15660-V-SQ	156 x 60	2	2	27,124	26,042	25,652	27,987	26,671	26,290
ACRT-16854-V-SQ	168 x 54	2	2	25,400	24,372	24,002	26,219	24,970	24,608
ACRT-16860-V-SQ	168 x 60	2	2	28,059	26,977	26,587	28,922	27,606	27,225
ACRT-18054-V-SQ	180 x 54	2	2	26,198	25,170	27,045	27,017	25,768	27,851
ACRT-18060-V-SQ	180 x 60	2	2	28,994	27,912	29,886	29,857	28,541	30,735
ACRT-19254-V-SQ	192 x 54	2	2	26,997	25,969	27,844	27,816	26,567	28,650
ACRT-19260-V-SQ	192 x 60	2	2	29,929	28,847	30,821	30,792	29,476	31,670
ACRT-19272-V-SQ	192 x 72	4	4	34,916	33,768	35,862	35,831	34,435	36,762
ACRT-20454-V-SQ	204 x 54	2	2	28,925	27,856	29,807	29,778	28,477	30,645
ACRT-20460-V-SQ	204 x 60	2	2	32,118	30,992	33,046	33,016	31,646	33,929
ACRT-20472-V-SQ	204 x 72	4	4	37,572	36,377	38,557	38,525	37,072	39,493
ACRT-21654-V-SQ	216 x 54	2	2	30,482	29,387	31,385	31,356	30,023	32,244
ACRT-21660-V-SQ	216 x 60	2	2	33,898	32,744	34,849	34,818	33,415	35,754
ACRT-21672-V-SQ	216 x 72	4	4	39,757	38,534	40,766	40,733	39,245	41,725
ACRT-22854-V-SQ	228 x 54	2	2	31,633	30,527	32,544	32,515	31,169	33,411
ACRT-22860-V-SQ	228 x 60	2	2	35,226	34,062	36,187	36,155	34,738	37,100
ACRT-22872-V-SQ	228 x 72	4	4	41,416	40,181	42,435	42,401	40,899	43,403
ACRT-24054-V-SQ	240 x 54	2	2	32,860	31,741	33,782	33,752	32,391	34,659
ACRT-24060-V-SQ	240 x 60	2	2	36,643	35,465	37,614	37,582	36,149	38,537
ACRT-24072-V-SQ	240 x 72	4	4	43,180	41,931	44,210	44,177	42,657	45,190

MATERIAL SELECTIONS	CODE	PRICE FOR 2-BASE TABLES (144" AND UNDER)	PRICE FOR 3-BASE TABLES	NOTES
Base Reveal Finish Options:				
Powder Coat	-PBR	No Charge	No Charge	Powder Coat is the only base reveal finish option available on Island Bases
Veneer	-VBR	\$1,669	\$2,504	
Clear Anodized	-CABR	No Charge	No Charge	
Polished Stainless	-APSBR	\$2,030	\$3,044	
Blackened Nickel	-ABNBR	\$2,030	\$3,044	
Chemetal	-CBR	\$2,030	\$3,044	
Satin Bronze Plating	-SBPBR	\$2,030	\$3,044	



VENEER TOP WITH HARDWOOD EDGE

OPTIONS	CODE	PRICE	NOTES
Wireless Charging (Table Top Power) Options:			
96"	-WCH	\$1,474	96" include 4 Charging Units
108"-132" Tables	-WCH	\$2,209	108"-132" include 6 Charging Units
144"-168" Tables	-WCH	\$2,945	144"-168" include 8 Charging Units
180"-240" Tables	-WCH	\$3,657	180"-240" include 10 Charging Units
Field-Wired:	-FW	No Charge	

GENERAL INFORMATION

- Top sections noted are for tables without Power Matrix units. When Power Matrix units are specified on the table, the top sections are determined by the size of the table and the size and quantity of the Power Matrix units. Please refer to page 15 for section information with Power Matrix units.
- Subtop sections listed are for tables with no power drawers or low profile perimeter power
- Veneer on base panels is vertical
- Wireless charging can be specified with any other power option on the same table
- Power Drawers and Low Profile Perimeter Power units not available on 2" Square profile tables
- If any finish other than Powder Coat is selected on the base reveal, the 3/4" above and below the base panels defaults to black if no other selection is made
- The reveal finish selection will include all interior surfaces on Open Panel bases
- Powder coat is the only option for the Island Base Reveal
- An optional Wire Chase column can be specified for more robust wire management needs on tables 96"-144"L with an Open or Closed Panel Base. See pages 29 and 38 for additional information.

REQUIRED INFORMATION (ORDER CANNOT BE ENTERED WITHOUT THIS INFORMATION)

See appendix pages vi-vii for surface material options.

- Choose Veneer Finish
- Choose Metal Finish for Beam
- Choose Paint Finish, if painted base (-POP, -PCP or -PVN) is specified
- Choose Chemetal Finish, if specified as a reveal finish (-CBR)



VENEER TOP WITH HARDWOOD EDGE

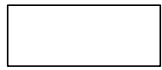

RECTANGLE TOP

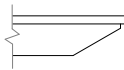

SQUARE EDGE

BASE KEY

POP	Painted Open Panel	VOP	Veneer Open Panel
PCP	Painted Closed Panel	VCP	Veneer Closed Panel
PVN	Painted Island	VVN	Veneer Island

VENEER TOP WITH HARDWOOD EDGE

MODEL #	L x W	TOP SECTIONS	SUBTOP SECTIONS	-POP	-PCP	-PVN	-VOP	-VCP	-VVN
ACRT-9642-V-SQC	96 x 42	1	1	11,745	11,223	13,538	12,160	11,526	14,000
ACRT-9648-V-SQC	96 x 48	1	1	12,709	12,169	14,564	13,139	12,483	15,041
ACRT-10842-V-SQC	108 x 42	1	1	12,896	12,346	14,789	13,335	12,666	15,276
ACRT-10848-V-SQC	108 x 48	1	1	14,005	13,436	15,964	14,459	13,767	16,468
ACRT-10854-V-SQC	108 x 54	1	1	15,322	14,727	17,367	15,796	15,072	17,893
ACRT-12042-V-SQC	120 x 42	1	1	14,101	13,521	16,093	14,563	13,858	16,606
ACRT-12048-V-SQC	120 x 48	1	1	15,364	14,764	17,425	15,841	15,112	17,956
ACRT-12054-V-SQC	120 x 54	1	1	16,858	16,232	19,011	17,357	16,595	19,565
ACRT-13248-V-SQC	132 x 48	2	2	16,650	16,026	18,798	17,148	16,389	19,350
ACRT-13254-V-SQC	132 x 54	2	2	18,320	17,668	20,563	18,840	18,047	21,140
ACRT-14448-V-SQC	144 x 48	2	2	17,990	17,341	20,223	18,508	17,718	20,798
ACRT-14454-V-SQC	144 x 54	2	2	19,843	19,165	22,176	20,384	19,559	22,776
ACRT-14460-V-SQC	144 x 60	2	2	22,010	21,295	24,466	22,579	21,710	25,098
ACRT-15648-V-SQC	156 x 48	2	2	22,449	21,465	21,110	23,233	22,037	21,691
ACRT-15654-V-SQC	156 x 54	2	2	24,601	23,573	23,203	25,420	24,171	23,809
ACRT-15660-V-SQC	156 x 60	2	2	27,124	26,042	25,652	27,987	26,671	26,290
ACRT-16854-V-SQC	168 x 54	2	2	25,400	24,372	24,002	26,219	24,970	24,608
ACRT-16860-V-SQC	168 x 60	2	2	28,059	26,977	26,587	28,922	27,606	27,225
ACRT-18054-V-SQC	180 x 54	2	2	26,198	25,170	27,045	27,017	25,768	27,851
ACRT-18060-V-SQC	180 x 60	2	2	28,994	27,912	29,886	29,857	28,541	30,735
ACRT-19254-V-SQC	192 x 54	2	2	26,997	25,969	27,844	27,816	26,567	28,650
ACRT-19260-V-SQC	192 x 60	2	2	29,929	28,847	30,821	30,792	29,476	31,670
ACRT-19272-V-SQC	192 x 72	4	4	34,916	33,768	35,862	35,831	34,435	36,762
ACRT-20454-V-SQC	204 x 54	2	2	28,925	27,856	29,807	29,778	28,477	30,645
ACRT-20460-V-SQC	204 x 60	2	2	32,118	30,992	33,046	33,016	31,646	33,929
ACRT-20472-V-SQC	204 x 72	4	4	37,572	36,377	38,557	38,525	37,072	39,493
ACRT-21654-V-SQC	216 x 54	2	2	30,482	29,387	31,385	31,356	30,023	32,244
ACRT-21660-V-SQC	216 x 60	2	2	33,898	32,744	34,849	34,818	33,415	35,754
ACRT-21672-V-SQC	216 x 72	4	4	39,757	38,534	40,766	40,733	39,245	41,725
ACRT-22854-V-SQC	228 x 54	2	2	31,633	30,527	32,544	32,515	31,169	33,411
ACRT-22860-V-SQC	228 x 60	2	2	35,226	34,062	36,187	36,155	34,738	37,100
ACRT-22872-V-SQC	228 x 72	4	4	41,416	40,181	42,435	42,401	40,899	43,403
ACRT-24054-V-SQC	240 x 54	2	2	32,860	31,741	33,782	33,752	32,391	34,659
ACRT-24060-V-SQC	240 x 60	2	2	36,643	35,465	37,614	37,582	36,149	38,537
ACRT-24072-V-SQC	240 x 72	4	4	43,180	41,931	44,210	44,177	42,657	45,190

MATERIAL SELECTIONS

	CODE	PRICE		
Subtop Finish Options:				
Paint	-PAP	No Charge	96"-120" Tables	132"-156" Tables
Veneer	-VAP	No Charge		
			168"-192" Tables	204"-240" Tables
			No Charge	No Charge
			No Charge	No Charge
Base Reveal Finish Options:				
Powder Coat	-PBR	No Charge	2-BASE TABLES (144" AND UNDER)	3-BASE TABLES
Veneer	-VBR	\$1,669		No Charge
Clear Anodized	-CABR	No Charge		\$2,504
Polished Stainless	-APSB	\$2,030		No Charge
Blackened Nickel	-ABNBR	\$2,030		\$3,044
Chemetal	-CBR	\$2,030		\$3,044
Satin Bronze Plating	-SBPBR	\$2,030		\$3,044
				NOTES
				Powder Coat is the only base reveal finish option available on Island Bases



VENEER TOP WITH HARDWOOD EDGE

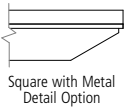

Square with Metal Detail Option

OPTIONS	CODE	PRICE			
Subtop Metal Detail Options:					
Powder Coat	-MTPB	\$1,017	96"-120" Tables	132"-156" Tables	168"-192" Tables
Polished Stainless	-MTAPS	\$1,436		\$1,077	\$1,139
Clear Anodized	-MTCA	\$1,017		\$1,596	\$1,757
				\$1,077	\$1,139
					\$1,197
					\$1,908
					\$1,197
Power & Data Options:					
See page 15 and 74-82					
Power Drawer Options:					
96" Tables	-PD4C	\$6,481	Includes 4 Power Drawers		
108"-132" Tables	-PD6C	\$9,721	Includes 6 Power Drawers		
144"-168" Tables	-PD8C	\$12,961	Includes 8 Power Drawers		
180"-240" Tables	-PD10C	\$16,201	Includes 10 Power Drawers		
Remove Power from (1) Power Drawer	-PD0	Deduct \$798	Adds 10" of storage space		
Low Profile Perimeter Power Options:					
96" Tables	-LPP4C	\$4,177	Includes 4 Low Profile Perimeter Power Units		
108"-132" Tables	-LPP6C	\$6,265	Includes 6 Low Profile Perimeter Power Units		
144"-168" Tables	-LPP8C	\$8,250	Includes 8 Low Profile Perimeter Power Units		
180"-240" Tables	-LPP10C	\$10,441	Includes 10 Low Profile Perimeter Power Units		
Lighted Low Profile Perimeter Power Options:					
Provides LED downlighting to illuminate faceplate					
96" Tables	-LTPP4C	\$5,713	Includes 4 Low Profile Perimeter Power Units with LED lighted option		
108"-132" Tables	-LTPP6C	\$8,386	Includes 6 Low Profile Perimeter Power Units with LED lighted option		
144"-168" Tables	-LTPP8C	\$11,059	Includes 8 Low Profile Perimeter Power Units with LED lighted option		
180"-240" Tables	-LTPP10C	\$13,732	Includes 10 Low Profile Perimeter Power Units with LED lighted option		
Wireless Charging (Table Top Power) Options:					
96"	-WCH	\$1,474	96" include 4 Charging Units		
108"-132" Tables	-WCH	\$2,209	108"-132" include 6 Charging Units		
144"-168" Tables	-WCH	\$2,945	144"-168" include 8 Charging Units		
180"-240" Tables	-WCH	\$3,657	180"-240" include 10 Charging Units		
Field-Wired:					
	-FW	No Charge			

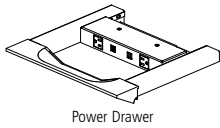

Power Drawer

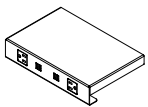

Low Profile Perimeter Power

GENERAL INFORMATION

- Top sections noted are for tables without Power Matrix units. When Power Matrix units are specified on the table, the top sections are determined by the size of the table and the size and quantity of the Power Matrix units. Please refer to page 15 for section information with Power Matrix units.
- Subtop sections listed are for tables with no power drawers or low profile perimeter power
- Veneer on base panels is vertical
- Subtop is set back 1/4" from edge of the table top
- Subtop is only available in Paint finish (-PAP) option when Paldeo veneer finish is selected for the top
- Wireless charging can be specified with any other power option on the same table
- Faceplate of the Low Profile Perimeter Power will default to beam color unless otherwise specified
- Metal detail option can be any metal finish (except Chemetal)
- Power Drawer and Low Profile Perimeter Power locations are set within the subtop and are in pre-determined quantities based on the size of the table and are in pre-determined quantities based on the size of the table
- Power Drawers and Perimeter Power Units have (2) Simplex / (2) USB-A+C Chargers on the long sides of the table and (1) Simplex / (1) USB-A+C Charger / 2 Extron Architectural Adaptor Plates (AAP) plates on the ends of the table
- If any finish other than Powder Coat is selected on the base reveal, the 3/4" above and below the base panels defaults to black if no other selection is made
- Power Drawer face is hardwood
- Power Drawer bottom defaults to Knoll Felt - Pewter
- Subtop has a hardwood rail
- Power Drawer has a space between the drawer and the bottom of the table for wire access/egress when the drawer is closed
- The reveal finish selection will include all interior surfaces on Open Panel bases
- Powder coat is the only option for the Island Base Reveal
- An optional Wire Chase column can be specified for more robust wire management needs on tables 96"-144"L with an Open or Closed Panel Base. See pages 29 and 38 for additional information.

REQUIRED INFORMATION (ORDER CANNOT BE ENTERED WITHOUT THIS INFORMATION)

See appendix pages vi-vii for surface material options.

- Choose Veneer Finish
- Choose Metal Finish for Beam
- Choose Paint Finish, if painted base (-POP, -PCP or -PVN) is specified, or if painted sub-top (-PAP) is specified. If multiple components are specified as painted, they will all be the same finish.
- Choose Chemetal Finish, if specified as a reveal finish (-CBR)



LAMINATE TOP WITH HARDWOOD EDGE

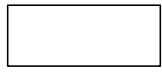

RECTANGLE TOP

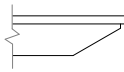

SQUARE EDGE

BASE KEY

POP	Painted Open Panel	VOP	Veneer Open Panel
PCP	Painted Closed Panel	VCP	Veneer Closed Panel
PVN	Painted Island	VVN	Veneer Island

LAMINATE TOP WITH HARDWOOD EDGE

MODEL #	L x W	TOP SECTIONS	SUBTOP SECTIONS	-POP	-PCP	-PVN	-VOP	-VCP	-VVN
ACRT-9642-P-SQC	96 x 42	1	1	11,334	10,831	13,065	11,735	11,123	13,510
ACRT-9648-P-SQC	96 x 48	1	1	12,265	11,744	14,055	12,680	12,047	14,515
ACRT-10842-P-SQC	108 x 42	1	1	12,445	11,914	14,272	12,869	12,223	14,742
ACRT-10848-P-SQC	108 x 48	1	1	13,515	12,966	15,406	13,953	13,286	15,892
ACRT-10854-P-SQC	108 x 54	1	1	14,786	14,212	16,760	15,244	14,545	17,267
ACRT-12042-P-SQC	120 x 42	1	1	13,608	13,048	15,530	14,054	13,373	16,025
ACRT-12048-P-SQC	120 x 48	1	1	14,827	14,248	16,816	15,287	14,584	17,328
ACRT-12054-P-SQC	120 x 54	1	1	16,268	15,664	18,346	16,750	16,015	18,881
ACRT-13248-P-SQC	132 x 48	2	2	16,068	15,466	18,141	16,548	15,816	18,673
ACRT-13254-P-SQC	132 x 54	2	2	17,679	17,050	19,844	18,181	17,416	20,401
ACRT-14448-P-SQC	144 x 48	2	2	17,361	16,735	19,516	17,861	17,098	20,071
ACRT-14454-P-SQC	144 x 54	2	2	19,149	18,495	21,400	19,671	18,875	21,979
ACRT-14460-P-SQC	144 x 60	2	2	21,240	20,550	23,610	21,789	20,951	24,220
ACRT-15648-P-SQC	156 x 48	2	2	21,664	20,714	20,372	22,420	21,266	20,932
ACRT-15654-P-SQC	156 x 54	2	2	23,740	22,748	22,391	24,531	23,326	22,976
ACRT-15660-P-SQC	156 x 60	2	2	26,175	25,131	24,755	27,008	25,738	25,370
ACRT-16854-P-SQC	168 x 54	2	2	24,511	23,519	23,162	25,302	24,097	23,747
ACRT-16860-P-SQC	168 x 60	2	2	27,077	26,033	25,657	27,910	26,640	26,273
ACRT-18054-P-SQC	180 x 54	2	2	25,282	24,290	26,099	26,072	24,867	26,877
ACRT-18060-P-SQC	180 x 60	2	2	27,980	26,936	28,840	28,813	27,543	29,660
ACRT-19254-P-SQC	192 x 54	2	2	26,053	25,061	26,870	26,843	25,638	27,648
ACRT-19260-P-SQC	192 x 60	2	2	28,882	27,838	29,743	29,715	28,445	30,562
ACRT-19272-P-SQC	192 x 72	4	4	33,694	32,587	34,607	34,577	33,230	35,476
ACRT-20454-P-SQC	204 x 54	2	2	27,913	26,882	28,764	28,736	27,481	29,573
ACRT-20460-P-SQC	204 x 60	2	2	30,994	29,908	31,890	31,861	30,539	32,742
ACRT-20472-P-SQC	204 x 72	4	4	36,257	35,104	37,208	37,177	35,775	38,111
ACRT-21654-P-SQC	216 x 54	2	2	29,416	28,359	30,287	30,259	28,973	31,116
ACRT-21660-P-SQC	216 x 60	2	2	32,712	31,598	33,630	33,600	32,246	34,503
ACRT-21672-P-SQC	216 x 72	4	4	38,366	37,186	39,340	39,308	37,872	40,265
ACRT-22854-P-SQC	228 x 54	2	2	30,526	29,459	31,405	31,377	30,079	32,242
ACRT-22860-P-SQC	228 x 60	2	2	33,994	32,870	34,921	34,890	33,523	35,802
ACRT-22872-P-SQC	228 x 72	4	4	39,967	38,775	40,950	40,917	39,468	41,884
ACRT-24054-P-SQC	240 x 54	2	2	31,710	30,631	32,600	32,571	31,258	33,446
ACRT-24060-P-SQC	240 x 60	2	2	35,361	34,224	36,298	36,267	34,884	37,189
ACRT-24072-P-SQC	240 x 72	4	4	41,669	40,464	42,663	42,631	41,165	43,609

MATERIAL SELECTIONS

	CODE	PRICE		
Subtop Finish Options:				
Paint	-PAP	No Charge	96"-120" Tables	132"-156" Tables
Veneer	-VAP	No Charge		
			168"-192" Tables	204"-240" Tables
			No Charge	No Charge
			No Charge	No Charge
Base Reveal Finish Options:				
Powder Coat	-PBR	No Charge	2-BASE TABLES (144" AND UNDER)	3-BASE TABLES
Veneer	-VBR	\$1,669		No Charge
Clear Anodized	-CABR	No Charge		\$2,504
Polished Stainless	-APSBR	\$2,030		No Charge
Blackened Nickel	-ABNBR	\$2,030		\$3,044
Chemetal	-CBR	\$2,030		\$3,044
Satin Bronze Plating	-SBPBR	\$2,030		\$3,044
				NOTES
				Powder Coat is the only base reveal finish option available on Island Bases



LAMINATE TOP WITH HARDWOOD EDGE

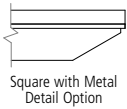

Square with Metal Detail Option

OPTIONS	CODE	PRICE			
Subtop Metal Detail Options:					
Powder Coat	-MTPB	96"-120" Tables	132"-156" Tables	168"-192" Tables	204"-240" Tables
Polished Stainless	-MTAPS	\$1,017	\$1,077	\$1,139	\$1,197
Clear Anodized	-MTCA	\$1,436	\$1,596	\$1,757	\$1,908
		\$1,017	\$1,077	\$1,139	\$1,197
Power & Data Options:		See page 17 and 74-82			
Power Drawer Options:					
96" Tables	-PD4C	\$6,481	Includes 4 Power Drawers		
108"-132" Tables	-PD6C	\$9,721	Includes 6 Power Drawers		
144"-168" Tables	-PD8C	\$12,961	Includes 8 Power Drawers		
180"-240" Tables	-PD10C	\$16,201	Includes 10 Power Drawers		
Remove Power from (1) Power Drawer	-PD0	Deduct \$798	Adds 10" of storage space		
Low Profile Perimeter Power Options:					
96" Tables	-LPP4C	\$4,177	Includes 4 Low Profile Perimeter Power Units		
108"-132" Tables	-LPP6C	\$6,265	Includes 6 Low Profile Perimeter Power Units		
144"-168" Tables	-LPP8C	\$8,250	Includes 8 Low Profile Perimeter Power Units		
180"-240" Tables	-LPP10C	\$10,441	Includes 10 Low Profile Perimeter Power Units		
Lighted Low Profile Perimeter Power Options:					
Provides LED downlighting to illuminate faceplate					
96" Tables	-LTPP4C	\$5,713	Includes 4 Low Profile Perimeter Power Units with LED lighted option		
108"-132" Tables	-LTPP6C	\$8,386	Includes 6 Low Profile Perimeter Power Units with LED lighted option		
144"-168" Tables	-LTPP8C	\$11,059	Includes 8 Low Profile Perimeter Power Units with LED lighted option		
180"-240" Tables	-LTPP10C	\$13,732	Includes 10 Low Profile Perimeter Power Units with LED lighted option		
Field-Wired:	-FW	No Charge			

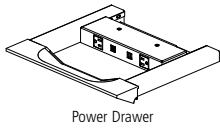

Power Drawer

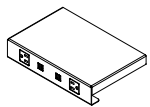

Low Profile Perimeter Power

GENERAL INFORMATION

- Top sections noted are for tables without Power Matrix units. When Power Matrix units are specified on the table, the top sections are determined by the size of the table and the size and quantity of the Power Matrix units. Please refer to page 17 for section information with Power Matrix units.
- Subtop sections listed are for tables with no power drawers or low profile perimeter power
- Veneer on base panels is vertical
- Subtop is set back 1/4" from edge of the table top
- Wireless charging can be specified with any other power option on the same table
- Faceplate of the Low Profile Perimeter Power will default to beam color unless otherwise specified
- Metal detail option can be any metal finish (except Chemetal)
- Power Drawer and Low Profile Perimeter Power locations are set within the subtop and are in pre-determined quantities based on the size of the table
- Power Drawers and Perimeter Power Units have (2) Simplex / (2) USB-A+C Chargers on the long sides of the table and (1) Simplex / (1) USB-A+C Charger / 2 Extron Architectural Adaptor Plates (AAP) plates on the ends of the table
- If any finish other than Powder Coat is selected on the base reveal, the 3/4" above and below the base panels defaults to black if no other selection is made
- Power Drawer face is hardwood
- Power Drawer bottom defaults to Knoll Felt - Pewter
- Subtop has a hardwood rail
- Power Drawer has a space between the drawer and the bottom of the table for wire access/egress when the drawer is closed
- The reveal finish selection will include all interior surfaces on Open Panel bases
- Powder coat is the only option for the Island Base Reveal
- An optional Wire Chase column can be specified for more robust wire management needs on tables 96"-144" L with an Open or Closed Panel Base. See pages 29 and 38 for additional information.

REQUIRED INFORMATION (ORDER CANNOT BE ENTERED WITHOUT THIS INFORMATION)

See appendix pages vi-vii for surface material options.

- Choose Laminate Finish
- Choose Veneer Finish
- Choose Metal Finish for Beam
- Choose Paint Finish, if painted base (-POP, -PCP or -PVN) is specified, or if painted sub-top (-PAP) is specified. If multiple components are specified as painted, they will all be the same finish.
- Choose Chemetal Finish, if specified as a reveal finish (-CBR)



LAMINATE TOP WITH ABS EDGE

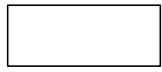

RECTANGLE TOP

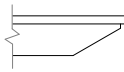

SQUARE EDGE

BASE KEY

POP	Painted Open Panel	VOP	Veneer Open Panel
PCP	Painted Closed Panel	VCP	Veneer Closed Panel
PVN	Painted Island	VVN	Veneer Island

LAMINATE TOP WITH ABS EDGE

MODEL #	L x W	TOP SECTIONS	SUBTOP SECTIONS	-POP	-PCP	-PVN	-VOP	-VCP	-VVN
ACRT-9642-PE-SQC	96 x 42	1	1	10,865	10,382	12,523	11,248	10,662	12,950
ACRT-9648-PE-SQC	96 x 48	1	1	11,756	11,257	13,472	12,154	11,547	13,913
ACRT-10842-PE-SQC	108 x 42	1	1	11,929	11,421	13,680	12,335	11,717	14,131
ACRT-10848-PE-SQC	108 x 48	1	1	12,955	12,429	14,767	13,375	12,735	15,233
ACRT-10854-PE-SQC	108 x 54	1	1	14,173	13,623	16,065	14,612	13,942	16,552
ACRT-12042-PE-SQC	120 x 42	1	1	13,044	12,507	14,887	13,471	12,819	15,361
ACRT-12048-PE-SQC	120 x 48	1	1	14,212	13,657	16,119	14,653	13,979	16,610
ACRT-12054-PE-SQC	120 x 54	1	1	15,594	15,015	17,586	16,056	15,351	18,098
ACRT-13248-PE-SQC	132 x 48	2	2	15,402	14,825	17,389	15,862	15,160	17,899
ACRT-13254-PE-SQC	132 x 54	2	2	16,946	16,343	19,021	17,427	16,694	19,555
ACRT-14448-PE-SQC	144 x 48	2	2	16,641	16,041	18,707	17,120	16,390	19,239
ACRT-14454-PE-SQC	144 x 54	2	2	18,355	17,728	20,513	18,856	18,093	21,068
ACRT-14460-PE-SQC	144 x 60	2	2	20,360	19,698	22,632	20,886	20,082	23,216
ACRT-15648-PE-SQC	156 x 48	2	2	20,766	19,856	19,527	21,491	20,385	20,065
ACRT-15654-PE-SQC	156 x 54	2	2	22,756	21,806	21,463	23,514	22,359	22,024
ACRT-15660-PE-SQC	156 x 60	2	2	25,090	24,089	23,729	25,888	24,671	24,319
ACRT-16854-PE-SQC	168 x 54	2	2	23,495	22,545	22,202	24,253	23,098	22,763
ACRT-16860-PE-SQC	168 x 60	2	2	25,955	24,954	24,593	26,753	25,536	25,184
ACRT-18054-PE-SQC	180 x 54	2	2	24,234	23,283	25,017	24,991	23,836	25,763
ACRT-18060-PE-SQC	180 x 60	2	2	26,820	25,819	27,645	27,618	26,401	28,430
ACRT-19254-PE-SQC	192 x 54	2	2	24,973	24,022	25,756	25,730	24,575	26,502
ACRT-19260-PE-SQC	192 x 60	2	2	27,685	26,684	28,510	28,483	27,266	29,295
ACRT-19272-PE-SQC	192 x 72	4	4	32,298	31,236	33,173	33,144	31,853	34,005
ACRT-20454-PE-SQC	204 x 54	2	2	26,756	25,767	27,572	27,545	26,342	28,347
ACRT-20460-PE-SQC	204 x 60	2	2	29,710	28,668	30,568	30,540	29,273	31,385
ACRT-20472-PE-SQC	204 x 72	4	4	34,755	33,649	35,666	35,636	34,292	36,532
ACRT-21654-PE-SQC	216 x 54	2	2	28,196	27,183	29,032	29,005	27,772	29,826
ACRT-21660-PE-SQC	216 x 60	2	2	31,356	30,289	32,236	32,207	30,909	33,073
ACRT-21672-PE-SQC	216 x 72	4	4	36,776	35,644	37,709	37,679	36,302	38,596
ACRT-22854-PE-SQC	228 x 54	2	2	29,261	28,238	30,104	30,077	28,832	30,906
ACRT-22860-PE-SQC	228 x 60	2	2	32,585	31,508	33,473	33,444	32,133	34,318
ACRT-22872-PE-SQC	228 x 72	4	4	38,310	37,168	39,253	39,221	37,832	40,148
ACRT-24054-PE-SQC	240 x 54	2	2	30,396	29,361	31,249	31,221	29,962	32,060
ACRT-24060-PE-SQC	240 x 60	2	2	33,895	32,806	34,793	34,764	33,438	35,647
ACRT-24072-PE-SQC	240 x 72	4	4	39,942	38,787	40,895	40,864	39,458	41,801

MATERIAL SELECTIONS

	CODE	PRICE		
Subtop Finish Options:				
Paint	-PAP	No Charge	96"-120" Tables	132"-156" Tables
Veneer	-VAP	No Charge		
			168"-192" Tables	204"-240" Tables
			No Charge	No Charge
			No Charge	No Charge
Base Reveal Finish Options:				
Powder Coat	-PBR	No Charge	2-BASE TABLES (144" AND UNDER)	3-BASE TABLES
Veneer	-VBR	\$1,669		No Charge
Clear Anodized	-CABR	No Charge		\$2,504
Polished Stainless	-APSB	\$2,030		No Charge
Blackened Nickel	-ABNBR	\$2,030		\$3,044
Chemetal	-CBR	\$2,030		\$3,044
Satin Bronze Plating	-SBPBR	\$2,030		\$3,044
				NOTES
				Powder Coat is the only base reveal finish option available on Island Bases



LAMINATE TOP WITH ABS EDGE

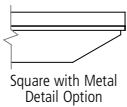

Square with Metal Detail Option

OPTIONS	CODE	PRICE			
Subtop Metal Detail Options:					
Powder Coat	-MTPB	96"-120" Tables	132"-156" Tables	168"-192" Tables	204"-240" Tables
Polished Stainless	-MTAPS	\$1,017	\$1,077	\$1,139	\$1,197
Clear Anodized	-MTCA	\$1,436	\$1,596	\$1,757	\$1,908
		\$1,017	\$1,077	\$1,139	\$1,197
Power & Data Options:		See page 17 and 74-82			
Power Drawer Options:					
96" Tables	-PD4C	\$6,481	Includes 4 Power Drawers		
108"-132" Tables	-PD6C	\$9,721	Includes 6 Power Drawers		
144"-168" Tables	-PD8C	\$12,961	Includes 8 Power Drawers		
180"-240" Tables	-PD10C	\$16,201	Includes 10 Power Drawers		
Remove Power from (1) Power Drawer	-PD0	Deduct \$798	Adds 10" of storage space		
Low Profile Perimeter Power Options:					
96" Tables	-LPP4C	\$4,177	Includes 4 Low Profile Perimeter Power Units		
108"-132" Tables	-LPP6C	\$6,265	Includes 6 Low Profile Perimeter Power Units		
144"-168" Tables	-LPP8C	\$8,250	Includes 8 Low Profile Perimeter Power Units		
180"-240" Tables	-LPP10C	\$10,441	Includes 10 Low Profile Perimeter Power Units		
Lighted Low Profile Perimeter Power Options:					
Provides LED downlighting to illuminate faceplate					
96" Tables	-LTPP4C	\$5,713	Includes 4 Low Profile Perimeter Power Units with LED lighted option		
108"-132" Tables	-LTPP6C	\$8,386	Includes 6 Low Profile Perimeter Power Units with LED lighted option		
144"-168" Tables	-LTPP8C	\$11,059	Includes 8 Low Profile Perimeter Power Units with LED lighted option		
180"-240" Tables	-LTPP10C	\$13,732	Includes 10 Low Profile Perimeter Power Units with LED lighted option		
Field-Wired:	-FW	No Charge			

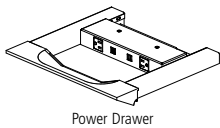

Power Drawer

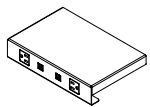

Low Profile Perimeter Power

GENERAL INFORMATION

- Top sections noted are for tables without Power Matrix units. When Power Matrix units are specified on the table, the top sections are determined by the size of the table and the size and quantity of the Power Matrix units. Please refer to page 17 for section information with Power Matrix units.
- Subtop sections listed are for tables with no power drawers or low profile perimeter power
- Veneer on base panels is vertical
- Subtop is set back 1/4" from edge of the table top
- Wireless charging can be specified with any other power option on the same table
- Faceplate of the Low Profile Perimeter Power will default to beam color unless otherwise specified
- Metal detail option can be any metal finish (except Chemetal)
- Power Drawer and Low Profile Perimeter Power locations are set within the subtop and are in pre-determined quantities based on the size of the table
- Power Drawers and Perimeter Power Units have (2) Simplex / (2) USB-A+C Chargers on the long sides of the table and (1) Simplex / (1) USB-A+C Charger / 2 Extron Architectural Adaptor Plates (AAP) plates on the ends of the table
- If any finish other than Powder Coat is selected on the base reveal, the 3/4" above and below the base panels defaults to black if no other selection is made
- Power Drawer face is hardwood
- Power Drawer bottom defaults to Knoll Felt - Pewter
- Subtop has a hardwood rail
- Power Drawer has a space between the drawer and the bottom of the table for wire access/egress when the drawer is closed
- The reveal finish selection will include all interior surfaces on Open Panel bases
- Powder coat is the only option for the Island Base Reveal
- An optional Wire Chase column can be specified for more robust wire management needs on tables 96"-144" L with an Open or Closed Panel Base. See pages 29 and 38 for additional information.

REQUIRED INFORMATION (ORDER CANNOT BE ENTERED WITHOUT THIS INFORMATION)

See appendix pages vi-vii for surface material options.

- Choose Laminate Finish
- Choose ABS Finish
- Choose Metal Finish for Beam
- Choose Paint Finish, if painted base (-POP, -PCP or -PVN) is specified, or if painted sub-top (-PAP) is specified. If multiple components are specified as painted, they will all be the same finish.
- Choose Chemetal Finish, if specified as a reveal finish (-CBR)



FENIX TOP WITH HARDWOOD EDGE

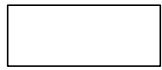

RECTANGLE TOP

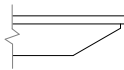

SQUARE EDGE

BASE KEY

POP	Painted Open Panel	VOP	Veneer Open Panel
PCP	Painted Closed Panel	VCP	Veneer Closed Panel
PVN	Painted Island	VVN	Veneer Island

FENIX TOP WITH HARDWOOD EDGE

MODEL #	L x W	TOP SECTIONS	SUBTOP SECTIONS	-POP	-PCP	-PVN	-VOP	-VCP	-VVN
ACRT-9642-X-SQC	96 x 42	1	1	12,450	11,897	14,351	12,890	12,218	14,840
ACRT-9648-X-SQC	96 x 48	1	1	13,472	12,900	15,438	13,928	13,232	15,944
ACRT-10842-X-SQC	108 x 42	1	1	13,670	13,087	15,677	14,136	13,426	16,193
ACRT-10848-X-SQC	108 x 48	1	1	14,846	14,243	16,922	15,327	14,594	17,457
ACRT-10854-X-SQC	108 x 54	1	1	16,242	15,611	18,410	16,744	15,977	18,967
ACRT-12042-X-SQC	120 x 42	1	1	14,948	14,333	17,059	15,437	14,690	17,603
ACRT-12048-X-SQC	120 x 48	1	1	16,286	15,650	18,471	16,792	16,019	19,034
ACRT-12054-X-SQC	120 x 54	1	1	17,870	17,206	20,152	18,399	17,591	20,739
ACRT-13248-X-SQC	132 x 48	2	2	17,649	16,988	19,926	18,177	17,373	20,511
ACRT-13254-X-SQC	132 x 54	2	2	19,420	18,729	21,797	19,971	19,130	22,409
ACRT-14448-X-SQC	144 x 48	2	2	19,070	18,382	21,437	19,619	18,782	22,046
ACRT-14454-X-SQC	144 x 54	2	2	21,034	20,315	23,507	21,608	20,733	24,143
ACRT-14460-X-SQC	144 x 60	2	2	23,331	22,573	25,934	23,934	23,013	26,604
ACRT-15648-X-SQC	156 x 48	2	2	23,796	22,753	22,377	24,627	23,360	22,993
ACRT-15654-X-SQC	156 x 54	2	2	26,078	24,988	24,596	26,946	25,622	25,238
ACRT-15660-X-SQC	156 x 60	2	2	28,752	27,605	27,192	29,667	28,272	27,868
ACRT-16854-X-SQC	168 x 54	2	2	26,924	25,835	25,443	27,793	26,469	26,085
ACRT-16860-X-SQC	168 x 60	2	2	29,743	28,596	28,183	30,658	29,263	28,859
ACRT-18054-X-SQC	180 x 54	2	2	27,770	26,681	28,668	28,639	27,315	29,523
ACRT-18060-X-SQC	180 x 60	2	2	30,734	29,587	31,680	31,649	30,254	32,580
ACRT-19254-X-SQC	192 x 54	2	2	28,617	27,528	29,515	29,485	28,162	30,369
ACRT-19260-X-SQC	192 x 60	2	2	31,725	30,578	32,671	32,640	31,245	33,571
ACRT-19272-X-SQC	192 x 72	4	4	37,011	35,795	38,014	37,981	36,502	38,968
ACRT-20454-X-SQC	204 x 54	2	2	30,661	29,528	31,596	31,565	30,186	32,484
ACRT-20460-X-SQC	204 x 60	2	2	34,046	32,852	35,029	34,997	33,545	35,965
ACRT-20472-X-SQC	204 x 72	4	4	39,827	38,560	40,871	40,837	39,297	41,863
ACRT-21654-X-SQC	216 x 54	2	2	32,311	31,151	33,269	33,238	31,825	34,179
ACRT-21660-X-SQC	216 x 60	2	2	35,932	34,709	36,940	36,908	35,420	37,900
ACRT-21672-X-SQC	216 x 72	4	4	42,143	40,847	43,212	43,177	41,600	44,229
ACRT-22854-X-SQC	228 x 54	2	2	33,531	32,359	34,497	34,466	33,040	35,416
ACRT-22860-X-SQC	228 x 60	2	2	37,340	36,106	38,359	38,325	36,823	39,326
ACRT-22872-X-SQC	228 x 72	4	4	43,901	42,592	44,982	44,946	43,353	46,008
ACRT-24054-X-SQC	240 x 54	2	2	34,832	33,646	35,809	35,778	34,335	36,739
ACRT-24060-X-SQC	240 x 60	2	2	38,842	37,593	39,871	39,837	38,318	40,850
ACRT-24072-X-SQC	240 x 72	4	4	45,771	44,447	46,863	46,828	45,217	47,902

MATERIAL SELECTIONS

	CODE	PRICE		
Subtop Finish Options:				
Paint	-PAP	No Charge	96"-120" Tables	132"-156" Tables
Veneer	-VAP	No Charge		
			168"-192" Tables	204"-240" Tables
			No Charge	No Charge
			No Charge	No Charge
Base Reveal Finish Options:				
Powder Coat	-PBR	No Charge	2-BASE TABLES (144" AND UNDER)	3-BASE TABLES
Veneer	-VBR	\$1,669		No Charge
Clear Anodized	-CABR	No Charge		\$2,504
Polished Stainless	-APSB	\$2,030		No Charge
Blackened Nickel	-ABNBR	\$2,030		\$3,044
Chemetal	-CBR	\$2,030		\$3,044
Satin Bronze Plating	-SBPBR	\$2,030		\$3,044
				NOTES
				Powder Coat is the only base reveal finish option available on Island Bases



FENIX TOP WITH HARDWOOD EDGE

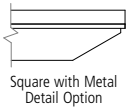

Square with Metal Detail Option

OPTIONS	CODE	PRICE			
Subtop Metal Detail Options:					
Powder Coat	-MTPB	96"-120" Tables	132"-156" Tables	168"-192" Tables	204"-240" Tables
Polished Stainless	-MTAPS	\$1,017	\$1,077	\$1,139	\$1,197
Clear Anodized	-MTCA	\$1,436	\$1,596	\$1,757	\$1,908
		\$1,017	\$1,077	\$1,139	\$1,197
Power & Data Options:			See page 17 and 74-82		
Power Drawer Options:					
96" Tables	-PD4C	\$6,481	Includes 4 Power Drawers		
108"-132" Tables	-PD6C	\$9,721	Includes 6 Power Drawers		
144"-168" Tables	-PD8C	\$12,961	Includes 8 Power Drawers		
180"-240" Tables	-PD10C	\$16,201	Includes 10 Power Drawers		
Remove Power from (1) Power Drawer	-PD0	Deduct \$798	Adds 10" of storage space		
Low Profile Perimeter Power Options:					
96" Tables	-LPP4C	\$4,177	Includes 4 Low Profile Perimeter Power Units		
108"-132" Tables	-LPP6C	\$6,265	Includes 6 Low Profile Perimeter Power Units		
144"-168" Tables	-LPP8C	\$8,250	Includes 8 Low Profile Perimeter Power Units		
180"-240" Tables	-LPP10C	\$10,441	Includes 10 Low Profile Perimeter Power Units		
Lighted Low Profile Perimeter Power Options:					
Provides LED downlighting to illuminate faceplate					
96" Tables	-LTPP4C	\$5,713	Includes 4 Low Profile Perimeter Power Units with LED lighted option		
108"-132" Tables	-LTPP6C	\$8,386	Includes 6 Low Profile Perimeter Power Units with LED lighted option		
144"-168" Tables	-LTPP8C	\$11,059	Includes 8 Low Profile Perimeter Power Units with LED lighted option		
180"-240" Tables	-LTPP10C	\$13,732	Includes 10 Low Profile Perimeter Power Units with LED lighted option		
Field-Wired:	-FW	No Charge			

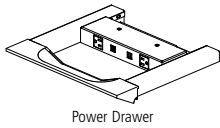

Power Drawer

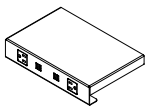

Low Profile Perimeter Power

GENERAL INFORMATION

- Top sections noted are for tables without Power Matrix units. When Power Matrix units are specified on the table, the top sections are determined by the size of the table and the size and quantity of the Power Matrix units. Please refer to page 17 for section information with Power Matrix units.
- Subtop sections listed are for tables with no power drawers or low profile perimeter power
- Veneer on base panels is vertical
- Subtop is set back 1/4" from edge of the table top
- Wireless charging can be specified with any other power option on the same table
- Faceplate of the Low Profile Perimeter Power will default to beam color unless otherwise specified
- Metal detail option can be any metal finish (except Chemetal)
- Power Drawer and Low Profile Perimeter Power locations are set within the subtop and are in pre-determined quantities based on the size of the table
- Power Drawers and Perimeter Power Units have (2) Simplex / (2) USB-A+C Chargers on the long sides of the table and (1) Simplex / (1) USB-A+C Charger / 2 Extron Architectural Adaptor Plates (AAP) plates on the ends of the table
- If any finish other than Powder Coat is selected on the base reveal, the 3/4" above and below the base panels defaults to black if no other selection is made
- Power Drawer face is hardwood
- Power Drawer bottom defaults to Knoll Felt - Pewter
- Subtop has a hardwood rail
- Power Drawer has a space between the drawer and the bottom of the table for wire access/egress when the drawer is closed
- The reveal finish selection will include all interior surfaces on Open Panel bases
- Powder coat is the only option for the Island Base Reveal
- An optional Wire Chase column can be specified for more robust wire management needs on tables 96"-144" L with an Open or Closed Panel Base. See pages 29 and 38 for additional information.

REQUIRED INFORMATION (ORDER CANNOT BE ENTERED WITHOUT THIS INFORMATION)

See appendix pages vi-vii for surface material options.

- Choose Fenix Finish
- Choose Veneer Finish
- Choose Metal Finish for Beam
- Choose Paint Finish, if painted base (-POP, -PCP or -PVN) is specified, or if painted sub-top (-PAP) is specified. If multiple components are specified as painted, they will all be the same finish.
- Choose Chemetal Finish, if specified as a reveal finish (-CBR)



FENIX TOP WITH EDGE BAND

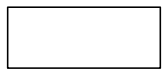

RECTANGLE TOP

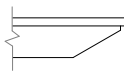

SQUARE EDGE

BASE KEY

POP	Painted Open Panel	VOP	Veneer Open Panel
PCP	Painted Closed Panel	VCP	Veneer Closed Panel
PVN	Painted Island	VVN	Veneer Island

FENIX TOP WITH EDGE BAND

MODEL #	L x W	TOP SECTIONS	SUBTOP SECTIONS	-POP	-PCP	-PVN	-VOP	-VCP	-VVN
ACRT-9642-XE-SQC	96 x 42	1	1	12,215	11,672	14,080	12,647	11,988	14,560
ACRT-9648-XE-SQC	96 x 48	1	1	13,218	12,656	15,147	13,665	12,983	15,643
ACRT-10842-XE-SQC	108 x 42	1	1	13,412	12,840	15,381	13,869	13,173	15,888
ACRT-10848-XE-SQC	108 x 48	1	1	14,566	13,974	16,603	15,038	14,318	17,127
ACRT-10854-XE-SQC	108 x 54	1	1	15,935	15,317	18,062	16,428	15,675	18,609
ACRT-12042-XE-SQC	120 x 42	1	1	14,666	14,062	16,737	15,146	14,413	17,271
ACRT-12048-XE-SQC	120 x 48	1	1	15,979	15,355	18,122	16,475	15,717	18,675
ACRT-12054-XE-SQC	120 x 54	1	1	17,533	16,882	19,772	18,052	17,259	20,348
ACRT-13248-XE-SQC	132 x 48	2	2	17,316	16,668	19,550	17,834	17,045	20,124
ACRT-13254-XE-SQC	132 x 54	2	2	19,053	18,375	21,386	19,594	18,769	21,986
ACRT-14448-XE-SQC	144 x 48	2	2	18,710	18,035	21,032	19,249	18,427	21,630
ACRT-14454-XE-SQC	144 x 54	2	2	20,637	19,932	23,064	21,200	20,342	23,688
ACRT-14460-XE-SQC	144 x 60	2	2	22,891	22,147	25,445	23,483	22,579	26,102
ACRT-15648-XE-SQC	156 x 48	2	2	23,347	22,324	21,955	24,163	22,919	22,559
ACRT-15654-XE-SQC	156 x 54	2	2	25,586	24,516	24,132	26,437	25,138	24,762
ACRT-15660-XE-SQC	156 x 60	2	2	28,209	27,084	26,679	29,107	27,738	27,342
ACRT-16854-XE-SQC	168 x 54	2	2	26,416	25,347	24,963	27,268	25,969	25,593
ACRT-16860-XE-SQC	168 x 60	2	2	29,182	28,057	27,651	30,079	28,711	28,314
ACRT-18054-XE-SQC	180 x 54	2	2	27,246	26,177	28,127	28,098	26,799	28,966
ACRT-18060-XE-SQC	180 x 60	2	2	30,154	29,029	31,082	31,052	29,683	31,965
ACRT-19254-XE-SQC	192 x 54	2	2	28,077	27,008	28,958	28,929	27,630	29,796
ACRT-19260-XE-SQC	192 x 60	2	2	31,127	30,001	32,054	32,024	30,656	32,937
ACRT-19272-XE-SQC	192 x 72	4	4	36,313	35,119	37,297	37,265	35,813	38,233
ACRT-20454-XE-SQC	204 x 54	2	2	30,082	28,971	31,000	30,970	29,617	31,871
ACRT-20460-XE-SQC	204 x 60	2	2	33,403	32,232	34,368	34,337	32,912	35,287
ACRT-20472-XE-SQC	204 x 72	4	4	39,075	37,833	40,100	40,066	38,555	41,073
ACRT-21654-XE-SQC	216 x 54	2	2	31,702	30,563	32,641	32,611	31,224	33,534
ACRT-21660-XE-SQC	216 x 60	2	2	35,254	34,054	36,243	36,211	34,752	37,185
ACRT-21672-XE-SQC	216 x 72	4	4	41,348	40,076	42,397	42,363	40,815	43,394
ACRT-22854-XE-SQC	228 x 54	2	2	32,899	31,749	33,846	33,816	32,416	34,748
ACRT-22860-XE-SQC	228 x 60	2	2	36,636	35,425	37,635	37,602	36,128	38,584
ACRT-22872-XE-SQC	228 x 72	4	4	43,073	41,789	44,133	44,098	42,535	45,140
ACRT-24054-XE-SQC	240 x 54	2	2	34,175	33,011	35,134	35,103	33,687	36,046
ACRT-24060-XE-SQC	240 x 60	2	2	38,109	36,884	39,119	39,086	37,595	40,079
ACRT-24072-XE-SQC	240 x 72	4	4	44,908	43,609	45,979	45,945	44,364	46,998

MATERIAL SELECTIONS

	CODE	PRICE		
Subtop Finish Options:				
Paint	-PAP	No Charge	96"-120" Tables	132"-156" Tables
Veneer	-VAP	No Charge		
			168"-192" Tables	204"-240" Tables
			No Charge	No Charge
			No Charge	No Charge
Base Reveal Finish Options:				
Powder Coat	-PBR	No Charge	2-BASE TABLES (144" AND UNDER)	3-BASE TABLES
Veneer	-VBR	\$1,669		No Charge
Clear Anodized	-CABR	No Charge		\$2,504
Polished Stainless	-APSB	\$2,030		No Charge
Blackened Nickel	-ABNBR	\$2,030		\$3,044
Chemetal	-CBR	\$2,030		\$3,044
Satin Bronze Plating	-SBPBR	\$2,030		\$3,044
				NOTES
				Powder Coat is the only base reveal finish option available on Island Bases



FENIX TOP WITH EDGE BAND

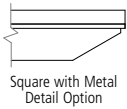

OPTIONS	CODE	PRICE				
Subtop Metal Detail Options:						
Powder Coat	-MTPB	\$1,017	96"-120" Tables	132"-156" Tables	168"-192" Tables	204"-240" Tables
Polished Stainless	-MTAPS	\$1,436		\$1,077	\$1,139	\$1,197
Clear Anodized	-MTCA	\$1,017		\$1,596	\$1,757	\$1,908
				\$1,077	\$1,139	\$1,197
Power & Data Options:			See page 17 and 74-82			
Power Drawer Options:						
96" Tables	-PD4C	\$6,481	Includes 4 Power Drawers			
108"-132" Tables	-PD6C	\$9,721	Includes 6 Power Drawers			
144"-168" Tables	-PD8C	\$12,961	Includes 8 Power Drawers			
180"-240" Tables	-PD10C	\$16,201	Includes 10 Power Drawers			
Remove Power from (1) Power Drawer	-PD0	Deduct \$798	Adds 10" of storage space			
Low Profile Perimeter Power Options:						
96" Tables	-LPP4C	\$4,177	Includes 4 Low Profile Perimeter Power Units			
108"-132" Tables	-LPP6C	\$6,265	Includes 6 Low Profile Perimeter Power Units			
144"-168" Tables	-LPP8C	\$8,250	Includes 8 Low Profile Perimeter Power Units			
180"-240" Tables	-LPP10C	\$10,441	Includes 10 Low Profile Perimeter Power Units			
Lighted Low Profile Perimeter Power Options:						
			Provides LED downlighting to illuminate faceplate			
96" Tables	-LTPP4C	\$5,713	Includes 4 Low Profile Perimeter Power Units with LED lighted option			
108"-132" Tables	-LTPP6C	\$8,386	Includes 6 Low Profile Perimeter Power Units with LED lighted option			
144"-168" Tables	-LTPP8C	\$11,059	Includes 8 Low Profile Perimeter Power Units with LED lighted option			
180"-240" Tables	-LTPP10C	\$13,732	Includes 10 Low Profile Perimeter Power Units with LED lighted option			
Field-Wired:	-FW	No Charge				

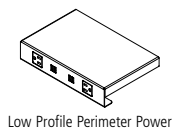
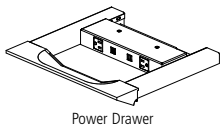

GENERAL INFORMATION

- Top sections noted are for tables without Power Matrix units. When Power Matrix units are specified on the table, the top sections are determined by the size of the table and the size and quantity of the Power Matrix units. Please refer to page 17 for section information with Power Matrix units.
- Subtop sections listed are for tables with no power drawers or low profile perimeter power
- Veneer on base panels is vertical
- Subtop is set back 1/4" from edge of the table top
- Wireless charging can be specified with any other power option on the same table
- Faceplate of the Low Profile Perimeter Power will default to beam color unless otherwise specified
- Metal detail option can be any metal finish (except Chemetal)
- Power Drawer and Low Profile Perimeter Power locations are set within the subtop and are in pre-determined quantities based on the size of the table
- Power Drawers and Perimeter Power Units have (2) Simplex / (2) USB-A+C Chargers on the long sides of the table and (1) Simplex / (1) USB-A+C Charger / 2 Extron Architectural Adaptor Plates (AAP) plates on the ends of the table
- If any finish other than Powder Coat is selected on the base reveal, the 3/4" above and below the base panels defaults to black if no other selection is made
- Power Drawer face is hardwood
- Power Drawer bottom defaults to Knoll Felt - Pewter
- Subtop has a hardwood rail
- Power Drawer has a space between the drawer and the bottom of the table for wire access/egress when the drawer is closed
- The reveal finish selection will include all interior surfaces on Open Panel bases
- Powder coat is the only option for the Island Base Reveal
- An optional Wire Chase column can be specified for more robust wire management needs on tables 96"-144" L with an Open or Closed Panel Base. See pages 29 and 38 for additional information.

REQUIRED INFORMATION (ORDER CANNOT BE ENTERED WITHOUT THIS INFORMATION)

See appendix pages vi-vii for surface material options.

- Choose Fenix Finish
- Choose 1mm Edgeband Finish
- Choose Metal Finish for Beam
- Choose Paint Finish, if painted base (-POP, -PCP or -PVN) is specified, or if painted sub-top (-PAP) is specified. If multiple components are specified as painted, they will all be the same finish.
- Choose Chemetal Finish, if specified as a reveal finish (-CBR)



GLASS TOP

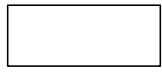

RECTANGLE TOP

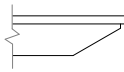

SQUARE EDGE

BASE KEY

POP	Painted Open Panel	VOP	Veneer Open Panel
PCP	Painted Closed Panel	VCP	Veneer Closed Panel
PVN	Painted Island	VVN	Veneer Island

GLASS TOP

MODEL #	L x W	TOP SECTIONS	SUBTOP SECTIONS	-POP	-PCP	-PVN	-VOP	-VCP	-VVN
ACRT-9642-G-SQC	96 x 42	1	1	16,150	15,432	18,615	16,720	15,849	19,250
ACRT-9648-G-SQC	96 x 48	1	1	17,475	16,733	20,026	18,067	17,165	20,682
ACRT-10842-G-SQC	108 x 42	1	1	17,732	16,976	20,335	18,336	17,416	21,005
ACRT-10848-G-SQC	108 x 48	2	1	19,257	18,475	21,951	19,882	18,930	22,644
ACRT-10854-G-SQC	108 x 54	2	1	21,068	20,250	23,880	21,720	20,724	24,603
ACRT-12042-G-SQC	120 x 42	1	1	19,389	18,592	22,128	20,025	19,055	22,834
ACRT-12048-G-SQC	120 x 48	2	1	21,126	20,301	23,960	21,782	20,779	24,690
ACRT-12054-G-SQC	120 x 54	2	1	23,180	22,319	26,141	23,866	22,819	26,902
ACRT-13248-G-SQC	132 x 48	2	2	22,894	22,036	25,848	23,579	22,535	26,607
ACRT-13254-G-SQC	132 x 54	2	2	25,190	24,294	28,275	25,905	24,815	29,068
ACRT-14448-G-SQC	144 x 48	2	2	24,737	23,844	27,807	25,449	24,363	28,598
ACRT-14454-G-SQC	144 x 54	2	2	27,285	26,352	30,492	28,028	26,894	31,317
ACRT-14460-G-SQC	144 x 60	2	2	30,264	29,281	33,641	31,047	29,852	34,510
ACRT-15648-G-SQC	156 x 48	2	2	30,868	29,515	29,027	31,946	30,301	29,826
ACRT-15654-G-SQC	156 x 54	2	2	33,827	32,413	31,905	34,953	33,236	32,738
ACRT-15660-G-SQC	156 x 60	2	2	37,296	35,808	35,272	38,483	36,673	36,149
ACRT-16854-G-SQC	168 x 54	2	2	34,925	33,512	33,003	36,052	34,334	33,836
ACRT-16860-G-SQC	168 x 60	2	2	38,582	37,094	36,558	39,768	37,959	37,435
ACRT-18054-G-SQC	180 x 54	2	2	36,023	34,609	37,187	37,149	35,431	38,296
ACRT-18060-G-SQC	180 x 60	3	2	39,867	38,379	41,094	41,054	39,244	42,261
ACRT-19254-G-SQC	192 x 54	3	2	37,121	35,708	38,286	38,247	36,530	39,394
ACRT-19260-G-SQC	192 x 60	3	2	41,153	39,665	42,379	42,339	40,530	43,547
ACRT-19272-G-SQC	192 x 72	4	4	48,010	46,431	49,311	49,268	47,349	50,548
ACRT-20454-G-SQC	204 x 54	3	2	39,772	38,302	40,985	40,945	39,156	42,137
ACRT-20460-G-SQC	204 x 60	3	2	44,163	42,614	45,439	45,397	43,514	46,653
ACRT-20472-G-SQC	204 x 72	4	4	51,662	50,019	53,016	52,972	50,974	54,303
ACRT-21654-G-SQC	216 x 54	3	2	41,913	40,408	43,155	43,115	41,282	44,336
ACRT-21660-G-SQC	216 x 60	3	2	46,610	45,023	47,918	47,875	45,946	49,162
ACRT-21672-G-SQC	216 x 72	4	4	54,666	52,985	56,054	56,008	53,962	57,372
ACRT-22854-G-SQC	228 x 54	3	2	43,496	41,975	44,748	44,709	42,858	45,941
ACRT-22860-G-SQC	228 x 60	3	2	48,436	46,836	49,758	49,714	47,765	51,013
ACRT-22872-G-SQC	228 x 72	4	4	56,947	55,249	58,349	58,302	56,237	59,680
ACRT-24054-G-SQC	240 x 54	3	2	45,183	43,644	46,451	46,409	44,538	47,657
ACRT-24060-G-SQC	240 x 60	3	2	50,385	48,765	51,720	51,676	49,705	52,989
ACRT-24072-G-SQC	240 x 72	4	4	59,373	57,656	60,789	60,744	58,654	62,137

MATERIAL SELECTIONS

	CODE	PRICE					
Subtop Finish Options:			96"-120" Tables	132"-156" Tables	168"-192" Tables	204"-240" Tables	
Paint	-PAP	No Charge	No Charge	No Charge	No Charge	No Charge	
Veneer	-VAP	No Charge	No Charge	No Charge	No Charge	No Charge	
Satin Glass Option:			96" Tables	102"-132" Tables	144-180" Tables	192-228" Tables	240" Tables
Satin Glass	-FSG	\$633	\$843	\$1,055	\$2,640	\$2,760	
Base Reveal Finish Options:			2-BASE TABLES (144" AND UNDER)	3-BASE TABLES	NOTES		
Powder Coat	-PBR	No Charge	No Charge	No Charge	Powder Coat is the only base reveal finish option available on Island Bases		
Veneer	-VBR	\$1,669	\$2,504				
Clear Anodized	-CABR	No Charge	No Charge				
Polished Stainless	-APSBR	\$2,030	\$3,044				
Blackened Nickel	-ABNBR	\$2,030	\$3,044				
Chemetal	-CBR	\$2,030	\$3,044				
Satin Bronze Plating	-SBPBR	\$2,030	\$3,044				



GLASS TOP

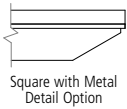

Square with Metal Detail Option

OPTIONS	CODE	PRICE				
Subtop Metal Detail Options:						
Powder Coat	-MTPB	\$1,017	96"-120" Tables	132"-156" Tables	168"-192" Tables	204"-240" Tables
Polished Stainless	-MTAPS	\$1,436		\$1,077	\$1,139	\$1,197
Clear Anodized	-MTCA	\$1,017		\$1,596	\$1,757	\$1,908
				\$1,077	\$1,139	\$1,197
Power & Data Options:			See page 18 and 74-82			
Power Drawer Options:						
96" Tables	-PD4C	\$6,481	Includes 4 Power Drawers			
108"-132" Tables	-PD6C	\$9,721	Includes 6 Power Drawers			
144"-168" Tables	-PD8C	\$12,961	Includes 8 Power Drawers			
180"-240" Tables	-PD10C	\$16,201	Includes 10 Power Drawers			
Remove Power from (1) Power Drawer	-PD0	Deduct \$798	Adds 10" of storage space			
Low Profile Perimeter Power Options:						
96" Tables	-LPP4C	\$4,177	Includes 4 Low Profile Perimeter Power Units			
108"-132" Tables	-LPP6C	\$6,265	Includes 6 Low Profile Perimeter Power Units			
144"-168" Tables	-LPP8C	\$8,250	Includes 8 Low Profile Perimeter Power Units			
180"-240" Tables	-LPP10C	\$10,441	Includes 10 Low Profile Perimeter Power Units			
Lighted Low Profile Perimeter Power Options:						
			Provides LED downlighting to illuminate faceplate			
96" Tables	-LTPP4C	\$5,713	Includes 4 Low Profile Perimeter Power Units with LED lighted option			
108"-132" Tables	-LTPP6C	\$8,386	Includes 6 Low Profile Perimeter Power Units with LED lighted option			
144"-168" Tables	-LTPP8C	\$11,059	Includes 8 Low Profile Perimeter Power Units with LED lighted option			
180"-240" Tables	-LTPP10C	\$13,732	Includes 10 Low Profile Perimeter Power Units with LED lighted option			
Field-Wired:		-FW	No Charge			

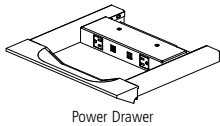

Power Drawer

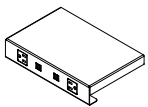

Low Profile Perimeter Power

GENERAL INFORMATION

- Top sections noted are for tables without Power Matrix units. When Power Matrix units are specified on the table, the top sections are determined by the size of the table and the size and quantity of the Power Matrix units. Please refer to page 18 for section information with Power Matrix units.
- Subtop sections listed are for tables with no power drawers or low profile perimeter power
- Veneer on base panels is vertical
- Subtop is set back 1/4" from edge of the table top
- Wireless charging can be specified with any other power option on the same table
- Faceplate of the Low Profile Perimeter Power will default to beam color unless otherwise specified
- Metal detail option can be any metal finish (except Chemetal)
- Power Drawer and Low Profile Perimeter Power locations are set within the subtop and are in pre-determined quantities based on the size of the table
- Power Drawers and Perimeter Power Units have (2) Simplex / (2) USB-A+C Chargers on the long sides of the table and (1) Simplex / (1) USB-A+C Charger / 2 Extron Architectural Adaptor Plates (AAP) plates on the ends of the table
- If any finish other than Powder Coat is selected on the base reveal, the 3/4" above and below the base panels defaults to black if no other selection is made
- Power Drawer face is hardwood
- Power Drawer bottom defaults to Knoll Felt - Pewter
- Subtop has a hardwood rail
- Power Drawer has a space between the drawer and the bottom of the table for wire access/egress when the drawer is closed
- The reveal finish selection will include all interior surfaces on Open Panel bases
- Powder coat is the only option for the Island Base Reveal
- An optional Wire Chase column can be specified for more robust wire management needs on tables 96"-144" L with an Open or Closed Panel Base. See pages 29 and 38 for additional information.

REQUIRED INFORMATION (ORDER CANNOT BE ENTERED WITHOUT THIS INFORMATION)

See appendix pages vi-vii for surface material options.

- Choose Glass Finish
- Choose Metal Finish for Beam
- Choose Veneer Finish, if Veneer base (-VOP, -VCP or -VVN) is specified, if Veneer sub-top (-VAP) is specified, or if Veneer is selected for Base Reveal (-VBR). If multiple components are specified as Veneer, they will all be the same finish.
- Choose Paint Finish, if painted base (-POP, -PCP or -PVN) is specified, or if painted sub-top (-PAP) is specified. If multiple components are specified as painted, they will all be the same finish.
- Choose Chemetal Finish, if specified as a reveal finish (-CBR)



STONE TOP

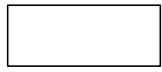

RECTANGLE TOP

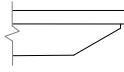

SQUARE EDGE

BASE KEY

POP	Painted Open Panel	VOP	Veneer Open Panel
PCP	Painted Closed Panel	VCP	Veneer Closed Panel
PVN	Painted Island	VVN	Veneer Island

STONE TOP

MODEL #	L x W	TOP SECTIONS	SUBTOP SECTIONS	-POP	-PCP	-PVN	-VOP	-VCP	-VVN
ACRT-9642-S-SQC	96 x 42	1	1	21,278	20,332	24,526	22,030	20,881	25,363
ACRT-9648-S-SQC	96 x 48	2	1	23,024	22,046	26,385	23,803	22,615	27,249
ACRT-10842-S-SQC	108 x 42	1	1	23,363	22,367	26,792	24,158	22,946	27,675
ACRT-10848-S-SQC	108 x 48	2	1	25,372	24,341	28,921	26,194	24,941	29,834
ACRT-10854-S-SQC	108 x 54	2	1	27,758	26,680	31,463	28,617	27,305	32,415
ACRT-12042-S-SQC	120 x 42	2	1	25,546	24,495	29,155	26,383	25,106	30,084
ACRT-12048-S-SQC	120 x 48	2	1	27,834	26,747	31,568	28,698	27,377	32,530
ACRT-12054-S-SQC	120 x 54	2	1	30,540	29,406	34,441	31,444	30,064	35,444
ACRT-13248-S-SQC	132 x 48	2	2	30,164	29,033	34,055	31,066	29,691	35,055
ACRT-13254-S-SQC	132 x 54	2	2	33,189	32,008	37,252	34,131	32,694	38,298
ACRT-14448-S-SQC	144 x 48	2	2	32,591	31,415	36,636	33,530	32,098	37,678
ACRT-14454-S-SQC	144 x 54	2	2	35,948	34,720	40,175	36,928	35,434	41,262
ACRT-14460-S-SQC	144 x 60	2	2	39,874	38,579	44,323	40,905	39,330	45,468
ACRT-15648-S-SQC	156 x 48	2	2	40,669	38,886	38,243	42,089	39,923	39,296
ACRT-15654-S-SQC	156 x 54	2	2	44,568	42,705	42,035	46,051	43,789	43,133
ACRT-15660-S-SQC	156 x 60	3	2	49,138	47,178	46,472	50,702	48,318	47,627
ACRT-16854-S-SQC	168 x 54	2	2	46,015	44,153	43,483	47,499	45,236	44,580
ACRT-16860-S-SQC	168 x 60	3	2	50,832	48,872	48,166	52,396	50,012	49,321
ACRT-18054-S-SQC	180 x 54	3	2	47,461	45,598	48,995	48,944	46,682	50,455
ACRT-18060-S-SQC	180 x 60	3	2	52,526	50,566	54,142	54,089	51,705	55,680
ACRT-19254-S-SQC	192 x 54	3	2	48,908	47,046	50,443	50,392	48,129	51,903
ACRT-19260-S-SQC	192 x 60	3	2	54,220	52,260	55,836	55,783	53,399	57,374
ACRT-19272-S-SQC	192 x 72	4	4	63,254	61,175	64,968	64,912	62,383	66,599
ACRT-20454-S-SQC	204 x 54	3	2	52,401	50,464	53,999	53,946	51,589	55,517
ACRT-20460-S-SQC	204 x 60	3	2	58,185	56,146	59,867	59,812	57,330	61,466
ACRT-20472-S-SQC	204 x 72	4	4	68,066	65,901	69,850	69,792	67,160	71,546
ACRT-21654-S-SQC	216 x 54	3	2	55,222	53,238	56,858	56,805	54,390	58,414
ACRT-21660-S-SQC	216 x 60	3	2	61,410	59,320	63,133	63,077	60,535	64,772
ACRT-21672-S-SQC	216 x 72	4	4	72,024	69,809	73,852	73,792	71,097	75,590
ACRT-22854-S-SQC	228 x 54	3	2	57,307	55,303	58,957	58,905	56,466	60,528
ACRT-22860-S-SQC	228 x 60	4	2	63,816	61,707	65,557	65,499	62,932	67,211
ACRT-22872-S-SQC	228 x 72	4	4	75,030	72,792	76,876	76,814	74,093	78,629
ACRT-24054-S-SQC	240 x 54	3	2	59,530	57,502	61,200	61,146	58,680	62,789
ACRT-24060-S-SQC	240 x 60	4	2	66,383	64,249	68,142	68,084	65,488	69,814
ACRT-24072-S-SQC	240 x 72	4	4	78,225	75,963	80,091	80,032	77,278	81,867

MATERIAL SELECTIONS

	CODE	PRICE		
Subtop Finish Options:				
Paint	-PAP	No Charge	96"-120" Tables	132"-156" Tables
Veneer	-VAP	No Charge		
			168"-192" Tables	204"-240" Tables
			No Charge	No Charge
			No Charge	No Charge
Base Reveal Finish Options:				
Powder Coat	-PBR	No Charge	2-BASE TABLES (144" AND UNDER)	3-BASE TABLES
Veneer	-VBR	\$1,669		No Charge
Clear Anodized	-CABR	No Charge		\$2,504
Polished Stainless	-APSB	\$2,030		No Charge
Blackened Nickel	-ABNBR	\$2,030		\$3,044
Chemetal	-CBR	\$2,030		\$3,044
Satin Bronze Plating	-SBPBR	\$2,030		\$3,044
				NOTES
				Powder Coat is the only base reveal finish option available on Island Bases



STONE TOP

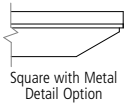

OPTIONS	CODE	PRICE				
Subtop Metal Detail Options:						
Powder Coat	-MTPB	\$1,017	96"-120" Tables	132"-156" Tables	168"-192" Tables	204"-240" Tables
Polished Stainless	-MTAPS	\$1,436		\$1,077	\$1,139	\$1,197
Clear Anodized	-MTCA	\$1,017		\$1,596	\$1,757	\$1,908
				\$1,077	\$1,139	\$1,197
Power & Data Options:			See page 19 and 74-82			
Power Drawer Options:						
96" Tables	-PD4C	\$6,481	Includes 4 Power Drawers			
108"-132" Tables	-PD6C	\$9,721	Includes 6 Power Drawers			
144"-168" Tables	-PD8C	\$12,961	Includes 8 Power Drawers			
180"-240" Tables	-PD10C	\$16,201	Includes 10 Power Drawers			
Remove Power from (1) Power Drawer	-PD0	Deduct \$798	Adds 10" of storage space			
Low Profile Perimeter Power Options:						
96" Tables	-LPP4C	\$4,177	Includes 4 Low Profile Perimeter Power Units			
108"-132" Tables	-LPP6C	\$6,265	Includes 6 Low Profile Perimeter Power Units			
144"-168" Tables	-LPP8C	\$8,250	Includes 8 Low Profile Perimeter Power Units			
180"-240" Tables	-LPP10C	\$10,441	Includes 10 Low Profile Perimeter Power Units			
Lighted Low Profile Perimeter Power Options:						
			Provides LED downlighting to illuminate faceplate			
96" Tables	-LTPP4C	\$5,713	Includes 4 Low Profile Perimeter Power Units with LED lighted option			
108"-132" Tables	-LTPP6C	\$8,386	Includes 6 Low Profile Perimeter Power Units with LED lighted option			
144"-168" Tables	-LTPP8C	\$11,059	Includes 8 Low Profile Perimeter Power Units with LED lighted option			
180"-240" Tables	-LTPP10C	\$13,732	Includes 10 Low Profile Perimeter Power Units with LED lighted option			
Field-Wired:	-FW	No Charge				

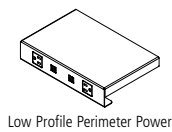
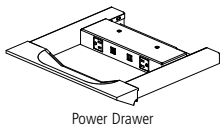

GENERAL INFORMATION

- Top sections noted are for tables without Power Matrix units. When Power Matrix units are specified on the table, the top sections are determined by the size of the table and the size and quantity of the Power Matrix units. Please refer to page 19 for section information with Power Matrix units.
- Subtop sections listed are for tables with no power drawers or low profile perimeter power
- Veneer on base panels is vertical
- Subtop is set back 1/4" from edge of the table top
- Wireless charging can be specified with any other power option on the same table
- Faceplate of the Low Profile Perimeter Power will default to beam color unless otherwise specified
- Metal detail option can be any metal finish (except Chemetal)
- Power Drawer and Low Profile Perimeter Power locations are set within the subtop and are in pre-determined quantities based on the size of the table
- Power Drawers and Perimeter Power Units have (2) Simplex / (2) USB-A+C Chargers on the long sides of the table and (1) Simplex / (1) USB-A+C Charger / 2 Extron Architectural Adaptor Plates (AAP) plates on the ends of the table
- If any finish other than Powder Coat is selected on the base reveal, the 3/4" above and below the base panels defaults to black if no other selection is made
- Power Drawer face is hardwood
- Power Drawer bottom defaults to Knoll Felt - Pewter
- Subtop has a hardwood rail
- Power Drawer has a space between the drawer and the bottom of the table for wire access/egress when the drawer is closed
- The reveal finish selection will include all interior surfaces on Open Panel bases
- Powder coat is the only option for the Island Base Reveal
- An optional Wire Chase column can be specified for more robust wire management needs on tables 96"-144" L with an Open or Closed Panel Base. See pages 29 and 38 for additional information.

REQUIRED INFORMATION (ORDER CANNOT BE ENTERED WITHOUT THIS INFORMATION)

See appendix pages vi-vii for surface material options.

- Choose Stone Finish
- Choose Metal Finish for Beam
- Choose Veneer Finish, if Veneer base (-VOP, -VCP or -VVN) is specified, if Veneer sub-top (-VAP) is specified, or if Veneer is selected for Base Reveal (-VBR). If multiple components are specified as Veneer, they will all be the same finish.
- Choose Paint Finish, if painted base (-POP, -PCP or -PVN) is specified, or if painted sub-top (-PAP) is specified. If multiple components are specified as painted, they will all be the same finish.
- Choose Chemetal Finish, if specified as a reveal finish (-CBR)



VENEER TOP WITH HARDWOOD EDGE

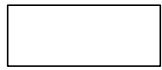

RECTANGLE TOP

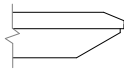

CHAMFER EDGE

BASE KEY

POP	Painted Open Panel	VOP	Veneer Open Panel
PCP	Painted Closed Panel	VCP	Veneer Closed Panel
PVN	Painted Island	VVN	Veneer Island

VENEER TOP WITH HARDWOOD EDGE

MODEL #	L x W	TOP SECTIONS	SUBTOP SECTIONS	-POP	-PCP	-PVN	-VOP	-VCP	-VVN
ACRT-9642-V-CC	96 x 42	1	1	12,007	11,474	13,840	12,432	11,784	14,313
ACRT-9648-V-CC	96 x 48	1	1	12,993	12,441	14,889	13,432	12,762	15,377
ACRT-10842-V-CC	108 x 42	1	1	13,184	12,622	15,119	13,633	12,949	15,617
ACRT-10848-V-CC	108 x 48	1	1	14,318	13,736	16,320	14,782	14,075	16,836
ACRT-10854-V-CC	108 x 54	1	1	15,664	15,056	17,755	16,149	15,409	18,293
ACRT-12042-V-CC	120 x 42	2	2	14,416	13,823	16,452	14,888	14,168	16,977
ACRT-12048-V-CC	120 x 48	2	2	15,707	15,094	17,814	16,195	15,449	18,357
ACRT-12054-V-CC	120 x 54	2	2	17,234	16,594	19,435	17,745	16,966	20,002
ACRT-13248-V-CC	132 x 48	2	2	17,022	16,384	19,218	17,531	16,755	19,782
ACRT-13254-V-CC	132 x 54	2	2	18,729	18,062	21,022	19,261	18,450	21,612
ACRT-14448-V-CC	144 x 48	2	2	18,392	17,728	20,674	18,921	18,114	21,262
ACRT-14454-V-CC	144 x 54	2	2	20,286	19,593	22,671	20,839	19,996	23,284
ACRT-14460-V-CC	144 x 60	2	2	22,501	21,770	25,012	23,083	22,195	25,658
ACRT-15648-V-CC	156 x 48	2	2	22,950	21,944	21,581	23,752	22,529	22,175
ACRT-15654-V-CC	156 x 54	2	2	25,150	24,099	23,721	25,987	24,711	24,340
ACRT-15660-V-CC	156 x 60	2	2	27,729	26,623	26,225	28,612	27,266	26,877
ACRT-16854-V-CC	168 x 54	2	2	25,967	24,916	24,538	26,804	25,527	25,157
ACRT-16860-V-CC	168 x 60	2	2	28,685	27,579	27,180	29,567	28,222	27,833
ACRT-18054-V-CC	180 x 54	2	2	26,783	25,732	27,649	27,620	26,343	28,473
ACRT-18060-V-CC	180 x 60	2	2	29,641	28,535	30,553	30,523	29,178	31,421
ACRT-19254-V-CC	192 x 54	2	2	27,600	26,549	28,465	28,437	27,160	29,289
ACRT-19260-V-CC	192 x 60	2	2	30,597	29,491	31,509	31,479	30,134	32,377
ACRT-19272-V-CC	192 x 72	4	4	35,695	34,522	36,662	36,631	35,203	37,582
ACRT-20454-V-CC	204 x 54	2	2	29,571	28,478	30,472	30,443	29,113	31,329
ACRT-20460-V-CC	204 x 60	2	2	32,835	31,684	33,783	33,753	32,352	34,686
ACRT-20472-V-CC	204 x 72	4	4	38,410	37,189	39,417	39,385	37,899	40,374
ACRT-21654-V-CC	216 x 54	2	2	31,162	30,043	32,085	32,056	30,693	32,964
ACRT-21660-V-CC	216 x 60	2	2	34,654	33,475	35,627	35,595	34,161	36,552
ACRT-21672-V-CC	216 x 72	4	4	40,644	39,394	41,676	41,642	40,121	42,656
ACRT-22854-V-CC	228 x 54	2	2	32,339	31,208	33,270	33,241	31,865	34,157
ACRT-22860-V-CC	228 x 60	2	2	36,012	34,822	36,994	36,962	35,513	37,928
ACRT-22872-V-CC	228 x 72	4	4	42,340	41,078	43,382	43,347	41,812	44,371
ACRT-24054-V-CC	240 x 54	2	2	33,593	32,449	34,536	34,505	33,114	35,432
ACRT-24060-V-CC	240 x 60	2	2	37,461	36,256	38,453	38,421	36,956	39,397
ACRT-24072-V-CC	240 x 72	4	4	44,143	42,867	45,196	45,163	43,609	46,198

MATERIAL SELECTIONS

	CODE	PRICE		
Subtop Finish Options:				
Paint	-PAP	No Charge	96"-120" Tables	132"-156" Tables
Veneer	-VAP	No Charge		
			168"-192" Tables	204"-240" Tables
			No Charge	No Charge
			No Charge	No Charge
Base Reveal Finish Options:				
Powder Coat	-PBR	No Charge	2-BASE TABLES (144" AND UNDER)	3-BASE TABLES
Veneer	-VBR	\$1,669		No Charge
Clear Anodized	-CABR	No Charge		\$2,504
Polished Stainless	-APSB	\$2,030		No Charge
Blackened Nickel	-ABNBR	\$2,030		\$3,044
Chemetal	-CBR	\$2,030		\$3,044
Satin Bronze Plating	-SBPBR	\$2,030		\$3,044
				NOTES
				Powder Coat is the only base reveal finish option available on Island Bases



VENEER TOP WITH HARDWOOD EDGE

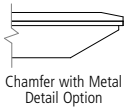

OPTIONS	CODE	PRICE				
Subtop Metal Detail Options:						
Powder Coat	-MTPB	\$1,017	96"-120" Tables	132"-156" Tables	168"-192" Tables	204"-240" Tables
Polished Stainless	-MTAPS	\$1,436		\$1,077	\$1,139	\$1,197
Clear Anodized	-MTCA	\$1,017		\$1,596	\$1,757	\$1,908
				\$1,077	\$1,139	\$1,197
Power & Data Options:			See pages 15-16 and 74-82			
Power Drawer Options:						
96" Tables	-PD4C	\$6,481	Includes 4 Power Drawers			
108"-132" Tables	-PD6C	\$9,721	Includes 6 Power Drawers			
144"-168" Tables	-PD8C	\$12,961	Includes 8 Power Drawers			
180"-240" Tables	-PD10C	\$16,201	Includes 10 Power Drawers			
Remove Power from (1) Power Drawer	-PD0	Deduct \$798	Adds 10" of storage space			
Low Profile Perimeter Power Options:						
96" Tables	-LPP4C	\$4,177	Includes 4 Low Profile Perimeter Power Units			
108"-132" Tables	-LPP6C	\$6,265	Includes 6 Low Profile Perimeter Power Units			
144"-168" Tables	-LPP8C	\$8,250	Includes 8 Low Profile Perimeter Power Units			
180"-240" Tables	-LPP10C	\$10,441	Includes 10 Low Profile Perimeter Power Units			
Lighted Low Profile Perimeter Power Options:						
			Provides LED downlighting to illuminate faceplate			
96" Tables	-LTPP4C	\$5,713	Includes 4 Low Profile Perimeter Power Units with LED lighted option			
108"-132" Tables	-LTPP6C	\$8,386	Includes 6 Low Profile Perimeter Power Units with LED lighted option			
144"-168" Tables	-LTPP8C	\$11,059	Includes 8 Low Profile Perimeter Power Units with LED lighted option			
180"-240" Tables	-LTPP10C	\$13,732	Includes 10 Low Profile Perimeter Power Units with LED lighted option			
Wireless Charging (Table Top Power) Options:						
96"	-WCH	\$1,474	96" include 4 Charging Units			
108"-132" Tables	-WCH	\$2,209	108"-132" include 6 Charging Units			
144"-168" Tables	-WCH	\$2,945	144"-168" include 8 Charging Units			
180"-240" Tables	-WCH	\$3,657	180"-240" include 10 Charging Units			
Field-Wired:	-FW	No Charge				

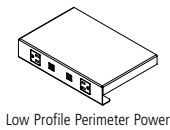
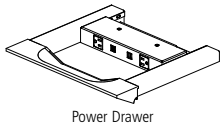

GENERAL INFORMATION

- Top sections noted are for tables without Power Matrix units. When Power Matrix units are specified on the table, the top sections are determined by the size of the table and the size and quantity of the Power Matrix units. Please refer to pages 15-16 for section information with Power Matrix units.
- Subtop sections listed are for tables with no power drawers or low profile perimeter power
- Veneer on base panels is vertical
- Subtop is set back 1/4" from edge of the table top
- Subtop is only available in Paint finish (-PAP) option when Paldeo veneer finish is selected for the top
- Wireless charging can be specified with any other power option on the same table
- Faceplate of the Low Profile Perimeter Power will default to beam color unless otherwise specified
- Metal detail option can be any metal finish (except Chemetal)
- Power Drawer and Low Profile Perimeter Power locations are set within the subtop and are in pre-determined quantities based on the size of the table and are in pre-determined quantities based on the size of the table
- Power Drawers and Perimeter Power Units have (2) Simplex / (2) USB-A+C Chargers on the long sides of the table and (1) Simplex / (1) USB-A+C Charger / 2 Extron Architectural Adaptor Plates (AAP) plates on the ends of the table
- If any finish other than Powder Coat is selected on the base reveal, the 3/4" above and below the base panels defaults to black if no other selection is made
- Power Drawer face is hardwood
- Power Drawer bottom defaults to Knoll Felt - Pewter
- Subtop has a hardwood rail
- Power Drawer has a space between the drawer and the bottom of the table for wire access/egress when the drawer is closed
- The reveal finish selection will include all interior surfaces on Open Panel bases
- Powder coat is the only option for the Island Base Reveal
- An optional Wire Chase column can be specified for more robust wire management needs on tables 96"-144"L with an Open or Closed Panel Base. See pages 29 and 38 for additional information.

REQUIRED INFORMATION (ORDER CANNOT BE ENTERED WITHOUT THIS INFORMATION)

See appendix pages vi-vii for surface material options.

- Choose Veneer Finish
- Choose Metal Finish for Beam
- Choose Paint Finish, if painted base (-POP, -PCP or -PVN) is specified, or if painted sub-top (-PAP) is specified. If multiple components are specified as painted, they will all be the same finish.
- Choose Chemetal Finish, if specified as a reveal finish (-CBR)



STONE TOP

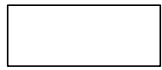

RECTANGLE TOP

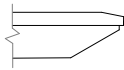

CHAMFER EDGE

BASE KEY

POP	Painted Open Panel	VOP	Veneer Open Panel
PCP	Painted Closed Panel	VCP	Veneer Closed Panel
PVN	Painted Island	VVN	Veneer Island

STONE TOP

MODEL #	L x W	TOP SECTIONS	SUBTOP SECTIONS	-POP	-PCP	-PVN	-VOP	-VCP	-VVN
ACRT-9642-S-CC	96 x 42	1	1	22,100	21,118	25,474	22,881	21,688	26,343
ACRT-9648-S-CC	96 x 48	2	1	23,914	22,898	27,404	24,723	23,489	28,302
ACRT-10842-S-CC	108 x 42	1	1	24,266	23,231	27,827	25,092	23,833	28,744
ACRT-10848-S-CC	108 x 48	2	1	26,352	25,282	30,038	27,207	25,904	30,987
ACRT-10854-S-CC	108 x 54	2	1	28,830	27,711	32,678	29,722	28,360	33,668
ACRT-12042-S-CC	120 x 42	2	1	26,533	25,442	30,281	27,402	26,076	31,246
ACRT-12048-S-CC	120 x 48	2	1	28,909	27,780	32,787	29,807	28,435	33,787
ACRT-12054-S-CC	120 x 54	2	1	31,721	30,543	35,772	32,659	31,226	36,814
ACRT-13248-S-CC	132 x 48	2	2	31,329	30,155	35,371	32,266	30,838	36,409
ACRT-13254-S-CC	132 x 54	2	2	34,471	33,245	38,692	35,450	33,958	39,778
ACRT-14448-S-CC	144 x 48	2	2	33,850	32,629	38,052	34,825	33,339	39,134
ACRT-14454-S-CC	144 x 54	2	2	37,337	36,061	41,727	38,355	36,803	42,856
ACRT-14460-S-CC	144 x 60	2	2	41,415	40,069	46,036	42,485	40,850	47,225
ACRT-15648-S-CC	156 x 48	2	2	42,241	40,389	39,721	43,716	41,465	40,814
ACRT-15654-S-CC	156 x 54	2	2	46,290	44,355	43,659	47,831	45,481	44,800
ACRT-15660-S-CC	156 x 60	3	2	51,037	49,001	48,267	52,661	50,185	49,468
ACRT-16854-S-CC	168 x 54	2	2	47,793	45,859	45,163	49,334	46,984	46,303
ACRT-16860-S-CC	168 x 60	3	2	52,796	50,760	50,027	54,420	51,944	51,227
ACRT-18054-S-CC	180 x 54	3	2	49,295	47,360	50,888	50,836	48,486	52,405
ACRT-18060-S-CC	180 x 60	3	2	54,556	52,520	56,234	56,179	53,703	57,831
ACRT-19254-S-CC	192 x 54	3	2	50,798	48,864	52,392	52,339	49,989	53,908
ACRT-19260-S-CC	192 x 60	3	2	56,315	54,279	57,993	57,939	55,463	59,591
ACRT-19272-S-CC	192 x 72	4	4	65,698	63,538	67,478	67,420	64,793	69,172
ACRT-20454-S-CC	204 x 54	3	2	54,426	52,414	56,085	56,031	53,583	57,662
ACRT-20460-S-CC	204 x 60	3	2	60,434	58,315	62,180	62,123	59,546	63,841
ACRT-20472-S-CC	204 x 72	4	4	70,696	68,447	72,549	72,489	69,755	74,311
ACRT-21654-S-CC	216 x 54	3	2	57,355	55,295	59,055	59,000	56,492	60,671
ACRT-21660-S-CC	216 x 60	3	2	63,783	61,612	65,572	65,514	62,874	67,275
ACRT-21672-S-CC	216 x 72	4	4	74,807	72,506	76,706	76,644	73,844	78,510
ACRT-22854-S-CC	228 x 54	3	2	59,521	57,440	61,235	61,181	58,648	62,867
ACRT-22860-S-CC	228 x 60	4	2	66,282	64,092	68,090	68,030	65,364	69,808
ACRT-22872-S-CC	228 x 72	4	4	77,929	75,605	79,846	79,782	76,956	81,668
ACRT-24054-S-CC	240 x 54	3	2	61,830	59,724	63,565	63,508	60,947	65,215
ACRT-24060-S-CC	240 x 60	4	2	68,948	66,731	70,775	70,715	68,018	72,512
ACRT-24072-S-CC	240 x 72	4	4	81,248	78,898	83,186	83,124	80,264	85,030

MATERIAL SELECTIONS

	CODE	PRICE		
Subtop Finish Options:				
Paint	-PAP	No Charge	96"-120" Tables	132"-156" Tables
Veneer	-VAP	No Charge		
			168"-192" Tables	204"-240" Tables
			No Charge	No Charge
			No Charge	No Charge
Base Reveal Finish Options:				
Powder Coat	-PBR	No Charge	2-BASE TABLES (144" AND UNDER)	3-BASE TABLES
Veneer	-VBR	\$1,669		No Charge
Clear Anodized	-CABR	No Charge		\$2,504
Polished Stainless	-APSB	\$2,030		No Charge
Blackened Nickel	-ABNBR	\$2,030		\$3,044
Chemetal	-CBR	\$2,030		\$3,044
Satin Bronze Plating	-SBPBR	\$2,030		\$3,044
				NOTES
				Powder Coat is the only base reveal finish option available on Island Bases



STONE TOP

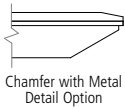

OPTIONS	CODE	PRICE				
Subtop Metal Detail Options:						
Powder Coat	-MTPB	\$1,017	96"-120" Tables	132"-156" Tables	168"-192" Tables	204"-240" Tables
Polished Stainless	-MTAPS	\$1,436		\$1,077	\$1,139	\$1,197
Clear Anodized	-MTCA	\$1,017		\$1,596	\$1,757	\$1,908
				\$1,077	\$1,139	\$1,197
Power & Data Options:			See page 19 and 74-82			
Power Drawer Options:						
96" Tables	-PD4C	\$6,481	Includes 4 Power Drawers			
108"-132" Tables	-PD6C	\$9,721	Includes 6 Power Drawers			
144"-168" Tables	-PD8C	\$12,961	Includes 8 Power Drawers			
180"-240" Tables	-PD10C	\$16,201	Includes 10 Power Drawers			
Remove Power from (1) Power Drawer	-PD0	Deduct \$798	Adds 10" of storage space			
Low Profile Perimeter Power Options:						
96" Tables	-LPP4C	\$4,177	Includes 4 Low Profile Perimeter Power Units			
108"-132" Tables	-LPP6C	\$6,265	Includes 6 Low Profile Perimeter Power Units			
144"-168" Tables	-LPP8C	\$8,250	Includes 8 Low Profile Perimeter Power Units			
180"-240" Tables	-LPP10C	\$10,441	Includes 10 Low Profile Perimeter Power Units			
Lighted Low Profile Perimeter Power Options:						
			Provides LED downlighting to illuminate faceplate			
96" Tables	-LTPP4C	\$5,713	Includes 4 Low Profile Perimeter Power Units with LED lighted option			
108"-132" Tables	-LTPP6C	\$8,386	Includes 6 Low Profile Perimeter Power Units with LED lighted option			
144"-168" Tables	-LTPP8C	\$11,059	Includes 8 Low Profile Perimeter Power Units with LED lighted option			
180"-240" Tables	-LTPP10C	\$13,732	Includes 10 Low Profile Perimeter Power Units with LED lighted option			
Field-Wired:	-FW	No Charge				

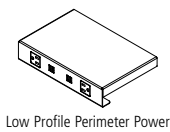
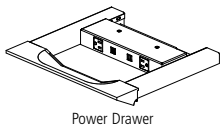

GENERAL INFORMATION

- Top sections noted are for tables without Power Matrix units. When Power Matrix units are specified on the table, the top sections are determined by the size of the table and the size and quantity of the Power Matrix units. Please refer to page 19 for section information with Power Matrix units.
- Subtop sections listed are for tables with no power drawers or low profile perimeter power
- Veneer on base panels is vertical
- Subtop is set back 1/4" from edge of the table top
- Wireless charging can be specified with any other power option on the same table
- Faceplate of the Low Profile Perimeter Power will default to beam color unless otherwise specified
- Metal detail option can be any metal finish (except Chemetal)
- Power Drawer and Low Profile Perimeter Power locations are set within the subtop and are in pre-determined quantities based on the size of the table
- Power Drawers and Perimeter Power Units have (2) Simplex / (2) USB-A+C Chargers on the long sides of the table and (1) Simplex / (1) USB-A+C Charger / 2 Extron Architectural Adaptor Plates (AAP) plates on the ends of the table
- If any finish other than Powder Coat is selected on the base reveal, the 3/4" above and below the base panels defaults to black if no other selection is made
- Power Drawer face is hardwood
- Power Drawer bottom defaults to Knoll Felt - Pewter
- Subtop has a hardwood rail
- Power Drawer has a space between the drawer and the bottom of the table for wire access/egress when the drawer is closed
- The reveal finish selection will include all interior surfaces on Open Panel bases
- Powder coat is the only option for the Island Base Reveal
- An optional Wire Chase column can be specified for more robust wire management needs on tables 96"-144" L with an Open or Closed Panel Base. See pages 29 and 38 for additional information.

REQUIRED INFORMATION (ORDER CANNOT BE ENTERED WITHOUT THIS INFORMATION)

See appendix pages vi-vii for surface material options.

- Choose Stone Finish
- Choose Metal Finish for Beam
- Choose Veneer Finish, if Veneer base (-VOP, -VCP or -VVN) is specified, if Veneer sub-top (-VAP) is specified, or if Veneer is selected for Base Reveal (-VBR). If multiple components are specified as Veneer, they will all be the same finish.
- Choose Paint Finish, if painted base (-POP, -PCP or -PVN) is specified, or if painted sub-top (-PAP) is specified. If multiple components are specified as painted, they will all be the same finish.
- Choose Chemetal Finish, if specified as a reveal finish (-CBR)



VENEER TOP WITH HARDWOOD EDGE

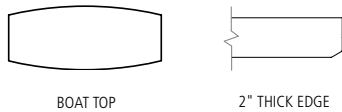

BASE KEY

POP	Painted Open Panel	VOP	Veneer Open Panel
PCP	Painted Closed Panel	VCP	Veneer Closed Panel
PVN	Painted Island	VVN	Veneer Island

VENEER TOP WITH HARDWOOD EDGE

MODEL #	L x W	TOP SECTIONS	SUBTOP SECTIONS	-POP	-PCP	-PVN	-VOP	-VCP	-VVN
ACNB-9648-V-SQ	96 x 36/48	1	1	12,709	12,169	14,564	13,139	12,483	15,041
ACNB-10848-V-SQ	108 x 36/48	1	1	14,005	13,436	15,964	14,459	13,767	16,468
ACNB-12050-V-SQ	120 x 36/50	1	1	16,317	15,691	18,470	16,816	16,054	19,024
ACNB-13254-V-SQ	132 x 36/54	2	2	18,320	17,668	20,563	18,840	18,047	21,140
ACNB-14454-V-SQ	144 x 36/54	2	2	19,843	19,165	22,176	20,384	19,559	22,776
ACNB-15654-V-SQ	156 x 36/54	2	2	24,601	23,573	23,203	25,420	24,171	23,809
ACNB-16860-V-SQ	168 x 42/60	2	2	28,059	26,977	26,587	28,922	27,606	27,225
ACNB-18060-V-SQ	180 x 42/60	2	2	28,994	27,912	29,886	29,857	28,541	30,735
ACNB-19272-V-SQ	192 x 54/72	4	4	34,916	33,768	35,862	35,831	34,435	36,762
ACNB-20472-V-SQ	204 x 54/72	4	4	37,572	36,377	38,557	38,525	37,072	39,493
ACNB-21672-V-SQ	216 x 54/72	4	4	39,757	38,534	40,766	40,733	39,245	41,725
ACNB-22872-V-SQ	228 x 54/72	4	4	41,416	40,181	42,435	42,401	40,899	43,403
ACNB-24072-V-SQ	240 x 54/72	4	4	43,180	41,931	44,210	44,177	42,657	45,190

MATERIAL SELECTIONS	CODE	PRICE FOR 2-BASE TABLES (144" AND UNDER)	PRICE FOR 3-BASE TABLES	NOTES
Base Reveal Finish Options:				
Powder Coat	-PBR	No Charge	No Charge	Powder Coat is the only base reveal finish option available on Island Bases
Veneer	-VBR	\$1,669	\$2,504	
Clear Anodized	-CABR	No Charge	No Charge	
Polished Stainless	-APSB	\$2,030	\$3,044	
Blackened Nickel	-ABNBR	\$2,030	\$3,044	
Chemetal	-CBR	\$2,030	\$3,044	
Satin Bronze Plating	-SBPBR	\$2,030	\$3,044	

OPTIONS	CODE	PRICE	NOTES
Wireless Charging (Table Top Power) Options:			
96" Tables	-WCH	\$1,474	96" include 4 Charging Units
108"-132" Tables	-WCH	\$2,209	108"-132" include 6 Charging Units
144"-168" Tables	-WCH	\$2,945	144"-168" include 8 Charging Units
180"-240" Tables	-WCH	\$3,657	180"-240" include 10 Charging Units
Field-Wired:	-FW	No Charge	

GENERAL INFORMATION

- Veneer on base panels is vertical
- Power Matrix availability can be found on page 15
- Wireless charging can be specified with any other power option on the same table
- Power Drawers and Low Profile Perimeter Power units not available on 2" Square profile tables
- If any finish other than Powder Coat is selected on the base reveal, the 3/4" above and below the base panels defaults to black if no other selection is made
- The reveal finish selection will include all interior surfaces on Open Panel bases
- Powder coat is the only option for the Island Base Reveal
- An optional Wire Chase column can be specified for more robust wire management needs on tables 96"-144"L with an Open or Closed Panel Base. See pages 29 and 38 for additional information.

REQUIRED INFORMATION (ORDER CANNOT BE ENTERED WITHOUT THIS INFORMATION)

- See appendix pages vi-vii for surface material options.
- Choose Veneer Finish
 - Choose Metal Finish for Beam
 - Choose Paint Finish, if painted base (-POP, -PCP or -PVN) is specified
 - Choose Chemetal Finish, if specified as a reveal finish (-CBR)



VENEER TOP WITH HARDWOOD EDGE

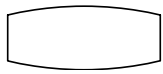

BOAT TOP

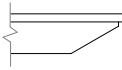

SQUARE EDGE

BASE KEY

POP	Painted Open Panel	VOP	Veneer Open Panel
PCP	Painted Closed Panel	VCP	Veneer Closed Panel
PVN	Painted Island	VVN	Veneer Island

VENEER TOP WITH HARDWOOD EDGE

MODEL #	L x W	TOP SECTIONS	SUBTOP SECTIONS	-POP	-PCP	-PVN	-VOP	-VCP	-VVN
ACNB-9648-V-SQC	96 x 36/48	1	1	12,709	12,169	14,564	13,139	12,483	15,041
ACNB-10848-V-SQC	108 x 36/48	1	1	14,005	13,436	15,964	14,459	13,767	16,468
ACNB-12050-V-SQC	120 x 36/50	1	1	16,317	15,691	18,470	16,816	16,054	19,024
ACNB-13254-V-SQC	132 x 36/54	2	2	18,320	17,668	20,563	18,840	18,047	21,140
ACNB-14454-V-SQC	144 x 36/54	2	2	19,843	19,165	22,176	20,384	19,559	22,776
ACNB-15654-V-SQC	156 x 36/54	2	2	24,601	23,573	23,203	25,420	24,171	23,809
ACNB-16860-V-SQC	168 x 42/60	2	2	28,059	26,977	26,587	28,922	27,606	27,225
ACNB-18060-V-SQC	180 x 42/60	2	2	28,994	27,912	29,886	29,857	28,541	30,735
ACNB-19272-V-SQC	192 x 54/72	4	4	34,916	33,768	35,862	35,831	34,435	36,762
ACNB-20472-V-SQC	204 x 54/72	4	4	37,572	36,377	38,557	38,525	37,072	39,493
ACNB-21672-V-SQC	216 x 54/72	4	4	39,757	38,534	40,766	40,733	39,245	41,725
ACNB-22872-V-SQC	228 x 54/72	4	4	41,416	40,181	42,435	42,401	40,899	43,403
ACNB-24072-V-SQC	240 x 54/72	4	4	43,180	41,931	44,210	44,177	42,657	45,190

MATERIAL SELECTIONS

	CODE	PRICE		
Subtop Finish Options:			96"-120" Tables	132"-156" Tables
Paint	-PAP	No Charge	No Charge	No Charge
Veneer	-VAP	No Charge	No Charge	No Charge
			168"-192" Tables	204"-240" Tables
			No Charge	No Charge
			No Charge	No Charge
Base Reveal Finish Options:			2-BASE TABLES (144" AND UNDER)	3-BASE TABLES
Powder Coat	-PBR	No Charge	No Charge	No Charge
Veneer	-VBR	\$1,669	\$2,504	
Clear Anodized	-CABR	No Charge	No Charge	
Polished Stainless	-APSBR	\$2,030	\$3,044	
Blackened Nickel	-ABNBR	\$2,030	\$3,044	
Chemetal	-CBR	\$2,030	\$3,044	
Satin Bronze Plating	-SBPBR	\$2,030	\$3,044	
				NOTES
				Powder Coat is the only base reveal finish option available on Island Bases



VENEER TOP WITH HARDWOOD EDGE

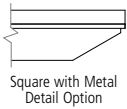

OPTIONS	CODE	PRICE			
Subtop Metal Detail Options:		96"-120" Tables	132"-156" Tables	168"-192" Tables	204"-240" Tables
Powder Coat	-MTPB	\$1,017	\$1,077	\$1,139	\$1,197
Polished Stainless	-MTAPS	\$1,436	\$1,596	\$1,757	\$1,908
Clear Anodized	-MTCA	\$1,017	\$1,077	\$1,139	\$1,197

Power & Data Options: See page 15 and 74-82

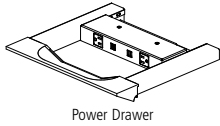

Power Drawer Options:			
96" Tables	-PD4C	\$6,481	Includes 4 Power Drawers
108"-132" Tables	-PD6C	\$9,721	Includes 6 Power Drawers
144"-168" Tables	-PD8C	\$12,961	Includes 8 Power Drawers
180"-240" Tables	-PD10C	\$16,201	Includes 10 Power Drawers
Remove Power from (1) Power Drawer	-PDO	Deduct \$798	Adds 10" of storage space

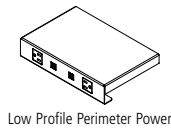

Low Profile Perimeter Power Options:			
96" Tables	-LPP4C	\$4,177	Includes 4 Low Profile Perimeter Power Units
108"-132" Tables	-LPP6C	\$6,265	Includes 6 Low Profile Perimeter Power Units
144"-168" Tables	-LPP8C	\$8,250	Includes 8 Low Profile Perimeter Power Units
180"-240" Tables	-LPP10C	\$10,441	Includes 10 Low Profile Perimeter Power Units

Lighted Low Profile Perimeter Power Options:			
96" Tables	-LTPP4C	\$5,713	Provides LED downlighting to illuminate faceplate
108"-132" Tables	-LTPP6C	\$8,386	Includes 4 Low Profile Perimeter Power Units with LED lighted option
144"-168" Tables	-LTPP8C	\$11,059	Includes 6 Low Profile Perimeter Power Units with LED lighted option
180"-240" Tables	-LTPP10C	\$13,732	Includes 8 Low Profile Perimeter Power Units with LED lighted option
			Includes 10 Low Profile Perimeter Power Units with LED lighted option

Wireless Charging (Table Top Power) Options:			
96"	-WCH	\$1,474	96" include 4 Charging Units
108"-132" Tables	-WCH	\$2,209	108"-132" include 6 Charging Units
144"-168" Tables	-WCH	\$2,945	144"-168" include 8 Charging Units
180"-240" Tables	-WCH	\$3,657	180"-240" include 10 Charging Units

Field-Wired: **-FW** No Charge

GENERAL INFORMATION

- Veneer on base panels is vertical
- Power Matrix availability can be found on page 15
- Subtop is set back 1/4" from edge of the table top
- Subtop is only available in Paint finish (-PAP) option when Paldeo veneer finish is selected for the top
- Wireless charging can be specified with any other power option on the same table
- Faceplate of the Low Profile Perimeter Power will default to beam color unless otherwise specified
- Metal detail option can be any metal finish (except Chemetal)
- Power Drawer and Low Profile Perimeter Power locations are set within the subtop and are in pre-determined quantities based on the size of the table and are in pre-determined quantities based on the size of the table
- Power Drawers and Perimeter Power Units have (2) Simplex / (2) USB-A+C Chargers on the long sides of the table and (1) Simplex / (1) USB-A+C Charger / 2 Extron Architectural Adaptor Plates (AAP) plates on the ends of the table
- If any finish other than Powder Coat is selected on the base reveal, the 3/4" above and below the base panels defaults to black if no other selection is made
- Power Drawer face is hardwood
- Power Drawer bottom defaults to Knoll Felt - Pewter
- Subtop has a hardwood rail
- Power Drawer has a space between the drawer and the bottom of the table for wire access/egress when the drawer is closed
- The reveal finish selection will include all interior surfaces on Open Panel bases
- Powder coat is the only option for the Island Base Reveal
- An optional Wire Chase column can be specified for more robust wire management needs on tables 96"-144"L with an Open or Closed Panel Base. See pages 29 and 38 for additional information.

REQUIRED INFORMATION (ORDER CANNOT BE ENTERED WITHOUT THIS INFORMATION)

- See appendix pages vi-vii for surface material options.
- Choose Veneer Finish
 - Choose Metal Finish for Beam
 - Choose Paint Finish, if painted base (-POP, -PCP or -PVN) is specified, or if painted sub-top (-PAP) is specified. If multiple components are specified as painted, they will all be the same finish.
 - Choose Chemetal Finish, if specified as a reveal finish (-CBR)



LAMINATE / FENIX TOPS

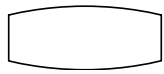

BOAT TOP

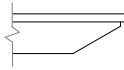

SQUARE EDGE

BASE KEY

POP	Painted Open Panel	VOP	Veneer Open Panel
PCP	Painted Closed Panel	VCP	Veneer Closed Panel
PVN	Painted Island	VVN	Veneer Island

LAMINATE TOP WITH HARDWOOD EDGE

MODEL #	L x W	TOP SECTIONS	SUBTOP SECTIONS	-POP	-PCP	-PVN	-VOP	-VCP	-VVN
ACNB-9648-P-SQC	96 x 36/48	1	1	12,265	11,744	14,055	12,680	12,047	14,515
ACNB-10848-P-SQC	108 x 36/48	1	1	13,515	12,966	15,406	13,953	13,286	15,892
ACNB-12050-P-SQC	120 x 36/50	1	1	15,746	15,142	17,824	16,228	15,493	18,359
ACNB-13254-P-SQC	132 x 36/54	2	2	17,679	17,050	19,844	18,181	17,416	20,401
ACNB-14454-P-SQC	144 x 36/54	2	2	19,149	18,495	21,400	19,671	18,875	21,979
ACNB-15654-P-SQC	156 x 36/54	2	2	23,740	22,748	22,391	24,531	23,326	22,976
ACNB-16860-P-SQC	168 x 42/60	2	2	27,077	26,033	25,657	27,910	26,640	26,273
ACNB-18060-P-SQC	180 x 42/60	2	2	27,980	26,936	28,840	28,813	27,543	29,660
ACNB-19272-P-SQC	192 x 54/72	4	4	33,694	32,587	34,607	34,577	33,230	35,476
ACNB-20472-P-SQC	204 x 54/72	4	4	36,257	35,104	37,208	37,177	35,775	38,111
ACNB-21672-P-SQC	216 x 54/72	4	4	38,366	37,186	39,340	39,308	37,872	40,265
ACNB-22872-P-SQC	228 x 54/72	4	4	39,967	38,775	40,950	40,917	39,468	41,884
ACNB-24072-P-SQC	240 x 54/72	4	4	41,669	40,464	42,663	42,631	41,165	43,609

LAMINATE TOP WITH ABS EDGE

MODEL #	L x W	TOP SECTIONS	SUBTOP SECTIONS	-POP	-PCP	-PVN	-VOP	-VCP	-VVN
ACNB-9648-PE-SQC	96 x 36/48	1	1	11,756	11,257	13,472	12,154	11,547	13,913
ACNB-10848-PE-SQC	108 x 36/48	1	1	12,955	12,429	14,767	13,375	12,735	15,233
ACNB-12050-PE-SQC	120 x 36/50	1	1	15,094	14,515	17,085	15,555	14,850	17,598
ACNB-13254-PE-SQC	132 x 36/54	2	2	16,946	16,343	19,021	17,427	16,694	19,555
ACNB-14454-PE-SQC	144 x 36/54	2	2	18,355	17,728	20,513	18,856	18,093	21,068
ACNB-15654-PE-SQC	156 x 36/54	2	2	22,756	21,806	21,463	23,514	22,359	22,024
ACNB-16860-PE-SQC	168 x 42/60	2	2	25,955	24,954	24,593	26,753	25,536	25,184
ACNB-18060-PE-SQC	180 x 42/60	2	2	26,820	25,819	27,645	27,618	26,401	28,430
ACNB-19272-PE-SQC	192 x 54/72	4	4	32,298	31,236	33,173	33,144	31,853	34,005
ACNB-20472-PE-SQC	204 x 54/72	4	4	34,755	33,649	35,666	35,636	34,292	36,532
ACNB-21672-PE-SQC	216 x 54/72	4	4	36,776	35,644	37,709	37,679	36,302	38,596
ACNB-22872-PE-SQC	228 x 54/72	4	4	38,310	37,168	39,253	39,221	37,832	40,148
ACNB-24072-PE-SQC	240 x 54/72	4	4	39,942	38,787	40,895	40,864	39,458	41,801

FENIX TOP WITH HARDWOOD EDGE

MODEL #	L x W	TOP SECTIONS	SUBTOP SECTIONS	-POP	-PCP	-PVN	-VOP	-VCP	-VVN
ACNB-9648-X-SQC	96 x 36/48	1	1	13,472	12,900	15,438	13,928	13,232	15,944
ACNB-10848-X-SQC	108 x 36/48	1	1	14,846	14,243	16,922	15,327	14,594	17,457
ACNB-12050-X-SQC	120 x 36/50	1	1	17,297	16,633	19,579	17,825	17,018	20,166
ACNB-13254-X-SQC	132 x 36/54	2	2	19,420	18,729	21,797	19,971	19,130	22,409
ACNB-14454-X-SQC	144 x 36/54	2	2	21,034	20,315	23,507	21,608	20,733	24,143
ACNB-15654-X-SQC	156 x 36/54	2	2	26,078	24,988	24,596	26,946	25,622	25,238
ACNB-16860-X-SQC	168 x 42/60	2	2	29,743	28,596	28,183	30,658	29,263	28,859
ACNB-18060-X-SQC	180 x 42/60	2	2	30,734	29,587	31,680	31,649	30,254	32,580
ACNB-19272-X-SQC	192 x 54/72	4	4	37,011	35,795	38,014	37,981	36,502	38,968
ACNB-20472-X-SQC	204 x 54/72	4	4	39,827	38,560	40,871	40,837	39,297	41,863
ACNB-21672-X-SQC	216 x 54/72	4	4	42,143	40,847	43,212	43,177	41,600	44,229
ACNB-22872-X-SQC	228 x 54/72	4	4	43,901	42,592	44,982	44,946	43,353	46,008
ACNB-24072-X-SQC	240 x 54/72	4	4	45,771	44,447	46,863	46,828	45,217	47,902



LAMINATE / FENIX TOPS

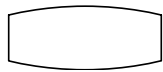

BOAT TOP

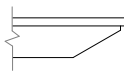

SQUARE EDGE

BASE KEY

POP	Painted Open Panel	VOP	Veneer Open Panel
PCP	Painted Closed Panel	VCP	Veneer Closed Panel
PVN	Painted Island	VVN	Veneer Island

FENIX TOP WITH EDGE BAND

MODEL #	L x W	TOP SECTIONS	SUBTOP SECTIONS	-POP	-PCP	-PVN	-VOP	-VCP	-VVN
ACNB-9648-XE-SQC	96 x 36/48	1	1	13,218	12,656	15,147	13,665	12,983	15,643
ACNB-10848-XE-SQC	108 x 36/48	1	1	14,566	13,974	16,603	15,038	14,318	17,127
ACNB-12050-XE-SQC	120 x 36/50	1	1	16,970	16,319	19,209	17,489	16,697	19,785
ACNB-13254-XE-SQC	132 x 36/54	2	2	19,053	18,375	21,386	19,594	18,769	21,986
ACNB-14454-XE-SQC	144 x 36/54	2	2	20,637	19,932	23,064	21,200	20,342	23,688
ACNB-15654-XE-SQC	156 x 36/54	2	2	25,586	24,516	24,132	26,437	25,138	24,762
ACNB-16860-XE-SQC	168 x 42/60	2	2	29,182	28,057	27,651	30,079	28,711	28,314
ACNB-18060-XE-SQC	180 x 42/60	2	2	30,154	29,029	31,082	31,052	29,683	31,965
ACNB-19272-XE-SQC	192 x 54/72	4	4	36,313	35,119	37,297	37,265	35,813	38,233
ACNB-20472-XE-SQC	204 x 54/72	4	4	39,075	37,833	40,100	40,066	38,555	41,073
ACNB-21672-XE-SQC	216 x 54/72	4	4	41,348	40,076	42,397	42,363	40,815	43,394
ACNB-22872-XE-SQC	228 x 54/72	4	4	43,073	41,789	44,133	44,098	42,535	45,140
ACNB-24072-XE-SQC	240 x 54/72	4	4	44,908	43,609	45,979	45,945	44,364	46,998

MATERIAL SELECTIONS

MATERIAL SELECTIONS	CODE	PRICE
Subtop Finish Options:		
Paint	-PAP	No Charge
Veneer	-VAP	No Charge
Base Reveal Finish Options:		
Powder Coat	-PBR	No Charge
Veneer	-VBR	\$1,669
Clear Anodized	-CABR	No Charge
Polished Stainless	-APSBR	\$2,030
Blackened Nickel	-ABNBR	\$2,030
Chemetal	-CBR	\$2,030
Satin Bronze Plating	-SBPBR	\$2,030

OPTIONS

OPTIONS	CODE	PRICE
Subtop Metal Detail Options:		
Powder Coat	-MTPB	\$1,017
Polished Stainless	-MTAPS	\$1,436
Clear Anodized	-MTCA	\$1,017
Power & Data Options:		
See page 17 and 74-82		
Power Drawer Options:		
96" Tables	-PD4C	\$6,481
108"-132" Tables	-PD6C	\$9,721
144"-168" Tables	-PD8C	\$12,961
180"-240" Tables	-PD10C	\$16,201
Remove Power from (1) Power Drawer	-PD0	Deduct \$798
Low Profile Perimeter Power Options:		
96" Tables	-LPP4C	\$4,177
108"-132" Tables	-LPP6C	\$6,265
144"-168" Tables	-LPP8C	\$8,250
180"-240" Tables	-LPP10C	\$10,441
Lighted Low Profile Perimeter Power Options:		
96" Tables	-LTTP4C	\$5,713
108"-132" Tables	-LTTP6C	\$8,386
144"-168" Tables	-LTTP8C	\$11,059
180"-240" Tables	-LTTP10C	\$13,732
Field-Wired:	-FW	No Charge

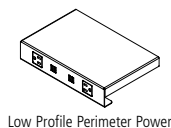
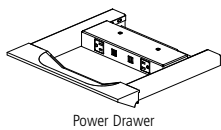
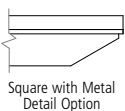



LAMINATE / FENIX TOPS

GENERAL INFORMATION

- Veneer on base panels is vertical
- Subtop is set back 1/4" from edge of the table top
- Wireless charging can be specified with any other power option on the same table
- Faceplate of the Low Profile Perimeter Power will default to beam color unless otherwise specified
- Metal detail option can be any metal finish (except Chemetal)
- Power Drawer and Low Profile Perimeter Power locations are set within the subtop and are in pre-determined quantities based on the size of the table
- Power Drawers and Perimeter Power Units have (2) Simplex / (2) USB-A+C Chargers on the long sides of the table and (1) Simplex / (1) USB-A+C Charger / 2 Extron Architectural Adaptor Plates (AAP) plates on the ends of the table
- If any finish other than Powder Coat is selected on the base reveal, the 3/4" above and below the base panels defaults to black if no other selection is made
- Power Drawer face is hardwood
- Power Drawer bottom defaults to Knoll Felt - Pewter
- Power Drawer has a space between the drawer and the bottom of the table for wire access/egress when the drawer is closed
- The reveal finish selection will include all interior surfaces on Open Panel bases
- Powder coat is the only option for the Island Base Reveal
- Subtop has a hardwood rail
- Power Matrix availability information is available on page 17
- An optional Wire Chase column can be specified for more robust wire management needs on tables 96"-144"L with an Open or Closed Panel Base. See pages 29 and 38 for additional information.

REQUIRED INFORMATION (ORDER CANNOT BE ENTERED WITHOUT THIS INFORMATION)

See appendix pages vi-vii for surface material options.

LAMINATE TOPS

- Choose Laminate Finish
- Choose Veneer Finish, if Hardwood Edge specified
- Choose ABS Finish, if ABS Edge specified
- Choose Paint Finish, if painted base (-POP, -PCP or -PVN) is specified, or if painted sub-top (-PAP) is specified. If multiple components are specified as painted, they will all be the same finish.
- Choose Chemetal Finish, if specified as a reveal finish (-CBR)

FENIX TOPS

- Choose Fenix Finish
- Choose Veneer Finish, if Hardwood Edge specified
- Choose 1mm Edgeband Finish, if 1mm Edgeband specified
- Choose Paint Finish, if painted base (-POP, -PCP or -PVN) is specified, or if painted sub-top (-PAP) is specified. If multiple components are specified as painted, they will all be the same finish.
- Choose Chemetal Finish, if specified as a reveal finish (-CBR)



GLASS / STONE TOPS

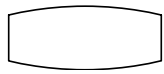

BOAT TOP

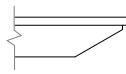

GLASS SQUARE EDGE

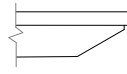

STONE SQUARE EDGE

BASE KEY

POP	Painted Open Panel	VOP	Veneer Open Panel
PCP	Painted Closed Panel	VCP	Veneer Closed Panel
PVN	Painted Island	VVN	Veneer Island

GLASS TOP

MODEL #	L x W	TOP SECTIONS	SUBTOP SECTIONS	-POP	-PCP	-PVN	-VOP	-VCP	-VVN
ACNB-9648-G-SQC	96 x 36/48	1	1	17,475	16,733	20,026	18,067	17,165	20,682
ACNB-10848-G-SQC	108 x 36/48	2	1	19,257	18,475	21,951	19,882	18,930	22,644
ACNB-12050-G-SQC	120 x 36/50	2	1	22,436	21,576	25,397	23,122	22,075	26,158
ACNB-13254-G-SQC	132 x 36/54	2	2	25,190	24,294	28,275	25,905	24,815	29,068
ACNB-14454-G-SQC	144 x 36/54	2	2	27,285	26,352	30,492	28,028	26,894	31,317
ACNB-15654-G-SQC	156 x 36/54	2	2	33,827	32,413	31,905	34,953	33,236	32,738
ACNB-16860-G-SQC	168 x 42/60	2	2	38,582	37,094	36,558	39,768	37,959	37,435
ACNB-18060-G-SQC	180 x 42/60	3	2	39,867	38,379	41,094	41,054	39,244	42,261
ACNB-19272-G-SQC	192 x 54/72	4	4	48,010	46,431	49,311	49,268	47,349	50,548
ACNB-20472-G-SQC	204 x 54/72	4	4	51,662	50,019	53,016	52,972	50,974	54,303
ACNB-21672-G-SQC	216 x 54/72	4	4	54,666	52,985	56,054	56,008	53,962	57,372
ACNB-22872-G-SQC	228 x 54/72	4	4	56,947	55,249	58,349	58,302	56,237	59,680
ACNB-24072-G-SQC	240 x 54/72	4	4	59,373	57,656	60,789	60,744	58,654	62,137

STONE TOP

MODEL #	L x W	TOP SECTIONS	SUBTOP SECTIONS	-POP	-PCP	-PVN	-VOP	-VCP	-VVN
ACNB-9648-S-SQC	96 x 36/48	2	1	23,893	22,878	27,381	24,702	23,469	28,278
ACNB-10848-S-SQC	108 x 36/48	2	1	26,330	25,260	30,013	27,183	25,882	30,960
ACNB-12050-S-SQC	120 x 36/50	2	1	30,676	29,500	34,724	31,615	30,182	35,766
ACNB-13254-S-SQC	132 x 36/54	2	2	34,442	33,216	38,659	35,420	33,929	39,744
ACNB-14454-S-SQC	144 x 36/54	2	2	37,305	36,031	41,691	38,322	36,771	42,819
ACNB-15654-S-SQC	156 x 36/54	2	2	46,250	44,318	43,622	47,790	45,442	44,761
ACNB-16860-S-SQC	168 x 42/60	3	2	52,751	50,717	49,984	54,374	51,900	51,183
ACNB-18060-S-SQC	180 x 42/60	3	2	54,509	52,475	56,186	56,132	53,658	57,782
ACNB-19272-S-SQC	192 x 54/72	4	4	65,643	63,484	67,421	67,363	64,738	69,113
ACNB-20472-S-SQC	204 x 54/72	4	4	70,636	68,389	72,488	72,427	69,696	74,247
ACNB-21672-S-SQC	216 x 54/72	4	4	74,744	72,444	76,641	76,579	73,781	78,443
ACNB-22872-S-SQC	228 x 54/72	4	4	77,863	75,541	79,778	79,714	76,891	81,598
ACNB-24072-S-SQC	240 x 54/72	4	4	81,179	78,831	83,115	83,053	80,196	84,958

MATERIAL SELECTIONS

CODE PRICE

Subtop Finish Options:

Paint	-PAP	96"-120" Tables	132"-156" Tables	168"-192" Tables	204"-240" Tables
Veneer	-VAP	No Charge	No Charge	No Charge	No Charge

Satin Glass Option:

Satin Glass	-FSG	96" Tables	102"-132" Tables	144-180" Tables	192-228" Tables	240" Tables
		\$633	\$843	\$1,055	\$2,640	\$2,760

Base Reveal Finish Options:

Powder Coat	-PBR	2-BASE TABLES (144" AND UNDER)	3-BASE TABLES	NOTES
Veneer	-VBR	No Charge	No Charge	Powder Coat is the only base reveal finish option available on Island Bases
Clear Anodized	-CABR	\$1,669	\$2,504	
Polished Stainless	-APSBR	No Charge	No Charge	
Blackened Nickel	-ABNBR	\$2,030	\$3,044	
Chemetal	-CBR	\$2,030	\$3,044	
Satin Bronze Plating	-SBPBR	\$2,030	\$3,044	



GLASS / STONE TOPS

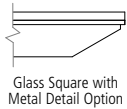

Glass Square with Metal Detail Option

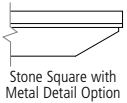

Stone Square with Metal Detail Option

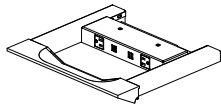

Power Drawer

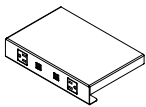

Low Profile Perimeter Power

OPTIONS	CODE	PRICE	
Subtop Metal Detail Options:			
Powder Coat	-MTPB	\$1,017	
Polished Stainless	-MTAPS	\$1,436	
Clear Anodized	-MTCA	\$1,017	
			96"-120" Tables 132"-156" Tables 168"-192" Tables 204"-240" Tables
			\$1,077 \$1,077 \$1,139 \$1,197
			\$1,596 \$1,596 \$1,757 \$1,908
			\$1,077 \$1,077 \$1,139 \$1,197
Power & Data Options:		See pages 18-19 and 74-82	
Power Drawer Options:			
96" Tables	-PD4C	\$6,481	Includes 4 Power Drawers
108"-132" Tables	-PD6C	\$9,721	Includes 6 Power Drawers
144"-168" Tables	-PD8C	\$12,961	Includes 8 Power Drawers
180"-240" Tables	-PD10C	\$16,201	Includes 10 Power Drawers
Remove Power from (1) Power Drawer	-PD0	Deduct \$798	Adds 10" of storage space
Low Profile Perimeter Power Options:			
96" Tables	-LPP4C	\$4,177	Includes 4 Low Profile Perimeter Power Units
108"-132" Tables	-LPP6C	\$6,265	Includes 6 Low Profile Perimeter Power Units
144"-168" Tables	-LPP8C	\$8,250	Includes 8 Low Profile Perimeter Power Units
180"-240" Tables	-LPP10C	\$10,441	Includes 10 Low Profile Perimeter Power Units
Lighted Low Profile Perimeter Power Options:			
96" Tables	-LTPP4C	\$5,713	Provides LED downlighting to illuminate faceplate
108"-132" Tables	-LTPP6C	\$8,386	Includes 4 Low Profile Perimeter Power Units with LED lighted option
144"-168" Tables	-LTPP8C	\$11,059	Includes 6 Low Profile Perimeter Power Units with LED lighted option
180"-240" Tables	-LTPP10C	\$13,732	Includes 8 Low Profile Perimeter Power Units with LED lighted option
			Includes 10 Low Profile Perimeter Power Units with LED lighted option
Field-Wired:	-FW	No Charge	

GENERAL INFORMATION

- Veneer on base panels is vertical
- Subtop is set back 1/4" from edge of the table top
- Wireless charging can be specified with any other power option on the same table
- Faceplate of the Low Profile Perimeter Power will default to beam color unless otherwise specified
- Metal detail option can be any metal finish (except Chemetal)
- Power Drawer and Low Profile Perimeter Power locations are set within the subtop and are in pre-determined quantities based on the size of the table
- Power Drawers and Perimeter Power Units have (2) Simplex / (2) USB-A+C Chargers on the long sides of the table and (1) Simplex / (1) USB-A+C Charger / 2 Extron Architectural Adaptor Plates (AAP) plates on the ends of the table
- If any finish other than Powder Coat is selected on the base reveal, the 3/4" above and below the base panels defaults to black if no other selection is made
- Power Drawer face is hardwood
- Power Drawer bottom defaults to Knoll Felt - Pewter
- Power Drawer has a space between the drawer and the bottom of the table for wire access/egress when the drawer is closed
- The reveal finish selection will include all interior surfaces on Open Panel bases
- Powder coat is the only option for the Island Base Reveal
- Subtop has a hardwood rail
- Top sections noted are for tables without power units. When power units are specified in the table, the top sections are determined by the size of the power unit, quantity and location.
- An optional Wire Chase column can be specified for more robust wire management needs on tables 96"-144" L with an Open or Closed Panel Base. See pages 29 and 38 for additional information.

REQUIRED INFORMATION (ORDER CANNOT BE ENTERED WITHOUT THIS INFORMATION)

See appendix pages vi-vii for surface material options.

GLASS TOP

- Choose Glass Finish
- Choose Veneer Finish, if Veneer base (-VOP, -VCP or -VVN) is specified, if Veneer sub-top (-VAP) is specified, or if Veneer is selected for Base Reveal (-VBR). If multiple components are specified as Veneer, they will all be the same finish.
- Choose Paint Finish, if painted base (-POP, -PCP or -PVN) is specified, or if painted sub-top (-PAP) is specified. If multiple components are specified as painted, they will all be the same finish.
- Choose Chemetal Finish, if specified as a reveal finish (-CBR)

STONE TOP

- Choose Stone Finish
- Choose Veneer Finish, if Veneer base (-VOP, -VCP or -VVN) is specified, if Veneer sub-top (-VAP) is specified, or if Veneer is selected for Base Reveal (-VBR). If multiple components are specified as Veneer, they will all be the same finish.
- Choose Paint Finish, if painted base (-POP, -PCP or -PVN) is specified, or if painted sub-top (-PAP) is specified. If multiple components are specified as painted, they will all be the same finish.
- Choose Chemetal Finish, if specified as a reveal finish (-CBR)



POWER AND DATA OPTIONS

POWER MATRIX SMALL OR COMPACT	MODEL #	DESCRIPTION	W x D	SIMPLEX OUTLETS	BLANK	DATA*	PRICE
	PM-AC-SM-G	Small - Glass Door	6 x 5.375	2	2	1	1,489
	PM-AC-SM-M	Small - Metal Door	6 x 5.375	2	2	1	1,489
	PM-AC-SM-W	Small - Wood Door	6 x 5.375	2	2	1	1,878
	PM-AC-SM-G-C	Compact - Glass Door	6 x 5.375	2	2	1	1,489
	PM-AC-SM-M-C	Compact - Metal Door	6 x 5.375	2	2	1	1,489
	PM-AC-SM-W-C	Compact - Wood Door	6 x 5.375	2	2	1	1,878

*Each data faceplate includes two RJ-45 (Data) connectors

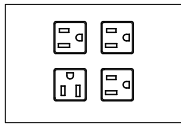

-FOUR

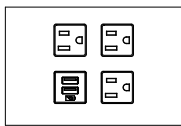

-THREE-C

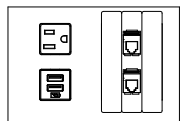

-USB-C

OPTIONS	CODE	PRICE	NOTES
4 Simplex Receptacles	Add -FOUR	No Charge	Replace AAP's with 2 additional simplex receptacles
3 Simplex Receptacles/Charging USB-A+C	Add -THREE-C	No Charge	Replace AAP's with 1 additional simplex receptacle and 1 charging USB-A+C
USB-A+C Charging	Add -USB-C	\$116 per unit	USB-A+C charger, replaces one of the simplex outlets
Polished Chrome Door	Add -PD	\$223 per unit	Only available with metal door option
Polished Chrome Bezel	Add -PB	\$317 per unit	Only available on glass, stone and laminate top tables
Field-Wired	Add -FW	Deduct \$43 per unit	May be required in New York City, Chicago and San Francisco. Check with an electrician for local codes and requirements.
Single Infeed Option Available	See page 78		

GENERAL INFORMATION

- Compact Power Matrix is the only option available on round tables
- For Veneer, Glass or Solid Surface tables, Power Matrix will be bezel free and the door will match the table top
- For Stone tables, Power Matrix will be bezel free and the door can be specified as metal or glass
- For Laminate or Fenix tables, Power Matrix will have a bezel and the door can be specified as metal or glass
- Wood species and finish will default to the same as the table top if wood door version is specified
- Power Matrix cord is 144" -long
- Glass doors are 3/8"-thick, metal doors are 1/8"-thick
- Wood doors are 1/4"-thick,
- Metal doors are 5/16"-thick
- Glass door is back-painted low-iron glass
- Glass door is square, and does not have the "file folder" design like the metal and wood Power Matrix doors
- Interior body is clear anodized aluminum
- Each unit includes a 15 amp, 12' power infeed (plug in only)
- If Field-Wired option is specified, each unit includes a 6' flexible metal conduit and requires a hardwire connection
- Standard configuration: Two simplex receptacles, two RJ-45 data connectors and two single blank faceplates
- Additional data/AV faceplate options are on page 81

REQUIRED INFORMATION: (ORDER CANNOT BE ENTERED WITHOUT THIS INFORMATION)

See appendix pages vi-vii for surface material options.

- Choose location code & quantity from the charts on pages 14-19
- Choose Glass Door Finish, if glass door version is specified
- Choose Metal Finish, if metal door version is specified or for the bezel finish on laminate tables

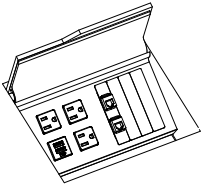

POWER AND DATA OPTIONS

POWER MATRIX MEDIUM	MODEL #	DESCRIPTION	W x D	SIMPLEX OUTLETS	BLANK	DATA*	PRICE
	PM-AC-MD-G	Medium - Glass Door	8.25 x 5.375	4	3	1	2,347
	PM-AC-MD-M	Medium - Metal Door	8.25 x 5.375	4	3	1	2,347
	PM-AC-MD-W	Medium - Wood Door	8.25 x 5.375	4	3	1	2,739

*Each data faceplate includes two RJ-45 (Data) connectors

OPTIONS	CODE	PRICE	NOTES
USB-A+C Charging	Add -USB-C	\$116 per unit	USB-A+C charger, replaces one of the simplex outlets
Polished Chrome Door	Add -PD	\$301 per unit	Only available with metal door option
Polished Chrome Bezel	Add -PB	\$354 per unit	Only available on glass, stone and laminate top tables
Field-Wired	Add -FW	Deduct \$43 per unit	May be required in New York City, Chicago and San Francisco. Check with an electrician for local codes and requirements.
Single Infeed Option Available	See page 78		

GENERAL INFORMATION

- For Veneer, Glass or Solid Surface tables, Power Matrix will be bezel free and the door will match the table top
- For Stone tables, Power Matrix will be bezel free and the door can be specified as metal or glass
- For Laminate or Fenix tables, Power Matrix will have a bezel and the door can be specified as metal or glass
- Wood species and finish will default to the same as the table top if wood door version is specified
- Power Matrix cord is 144"-long
- Glass doors are 3/8"-thick, metal doors are 1/8"-thick
- Wood doors are 1/4"-thick,
- Metal doors are 5/16"-thick
- Glass door is back-painted low-iron glass
- Glass door is square, and does not have the "file folder" design like the metal and wood Power Matrix doors
- Interior body is clear anodized aluminum
- Each unit includes a 15 amp, 12' power infeed (plug in only)
- If Field-Wired option is specified, each unit includes a 6' flexible metal conduit and requires a hardwire connection
- Standard configuration: Four simplex receptacles, two RJ-45 data connectors and three single blank faceplates
- Additional data/AV faceplate options are on page 81

REQUIRED INFORMATION: (ORDER CANNOT BE ENTERED WITHOUT THIS INFORMATION)

See appendix pages vi-vii for surface material options.

- Choose location code & quantity from the charts on pages 14-19
- Choose Glass Door Finish, if glass door version is specified
- Choose Metal Finish, if metal door version is specified or for the bezel finish on laminate and glass tables

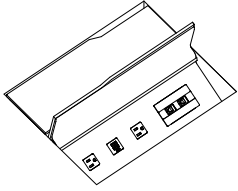

POWER AND DATA OPTIONS

POWER MATRIX LARGE	MODEL #	DESCRIPTION	W x D	SIMPLEX OUTLETS	BLANK	DATA*	PRICE
	PM-AC-LG-G	Large - Glass Door	15.25 x 10.25	6	4	2	3,912
	PM-AC-LG-M	Large - Metal Door	15.25 x 10.25	6	4	2	3,912
	PM-AC-LG-W	Large - Wood Door	15.25 x 10.25	6	4	2	4,535

*Each data faceplate includes two RJ-45 (Data) connectors

OPTIONS	CODE	PRICE	NOTES
USB-A+C Charging	Add -USB-C	\$226 per unit	USB-A+C charger, replaces one of the simplex outlets per side
Polished Chrome Door	Add -PD	\$738 per unit	Only available with metal door option
Polished Chrome Bezel	Add -PB	\$571 per unit	Only available on glass, stone and laminate top tables
Field-Wired	Add -FW	Deduct \$78 per unit	May be required in New York City, Chicago and San Francisco. Check with an electrician for local codes and requirements.
Single Infeed Option Available	See page 78		

GENERAL INFORMATION

- For Veneer, Glass or Solid Surface tables, Power Matrix will be bezel free and the door will match the table top
- For Stone tables, Power Matrix will be bezel free and the door can be specified as metal or glass
- For Laminate or Fenix tables, Power Matrix will have a bezel and the door can be specified as metal or glass
- Wood species and finish will default to the same as the table top if wood door version is specified
- Power Matrix cord is 144"-long
- Glass doors are 3/8"-thick, metal doors are 1/8"-thick
- Wood doors are 1/4"-thick,
- Metal doors are 5/16"-thick
- Glass door is back-painted low-iron glass
- Glass door is square, and does not have the "file folder" design like the metal and wood Power Matrix doors
- Interior body is clear anodized aluminum
- Each unit includes a 15 amp, 12' power infeed (plug in only)
- If Field-Wired option is specified, each unit includes a 6' flexible metal conduit and requires a hardwire connection
- Standard configuration: Six simplex receptacles, four RJ-45 data connectors and four single blank faceplates
- Additional data/AV faceplate options are on page 81

REQUIRED INFORMATION: (ORDER CANNOT BE ENTERED WITHOUT THIS INFORMATION)

- See appendix pages vi-vii for surface material options.
- Choose location code & quantity from the charts on pages 14-19
 - Choose Glass Door Finish, if glass door version is specified
 - Choose Metal Finish, if metal door version is specified or for the bezel finish on laminate tables



POWER AND DATA OPTIONS

POWER MATRIX EXTRA LARGE	MODEL #	DESCRIPTION	W x D	SIMPLEX OUTLETS	BLANK	DATA*	PRICE
	PM-AC-XL-G	Extra Large - Glass Door	30.25 x 10.75	8	8	4	5,472
	PM-AC-XL-M	Extra Large - Metal Door	30.25 x 10.75	8	8	4	5,472
	PM-AC-XL-W	Extra Large - Wood Door	30.25 x 10.75	8	8	4	6,099

*Each data faceplate includes two RJ-45 (Data) connectors

OPTIONS	CODE	PRICE	NOTES
USB-A+C Charging	Add -USB-C	\$226 per unit	USB-A+C charger, replaces one of the simplex outlets per side
Polished Chrome Door	Add -PD	\$1,035 per unit	Only available with metal door option
Polished Chrome Bezel	Add -PB	\$744 per unit	Only available on glass, stone and laminate top tables
Field-Wired	Add -FW	Deduct \$78 per unit	May be required in New York City, Chicago and San Francisco. Check with an electrician for local codes and requirements.
Single Infeed Option Available	See page 78		

GENERAL INFORMATION

- For Veneer, Glass or Solid Surface tables, Power Matrix will be bezel free and the door will match the table top
- For Stone tables, Power Matrix will be bezel free and the door can be specified as metal or glass
- For Laminate or Fenix tables, Power Matrix will have a bezel and the door can be specified as metal or glass
- Wood species and finish will default to the same as the table top if wood door version is specified
- Power Matrix cord is 144"-long
- Glass doors are 3/8"-thick, metal doors are 1/8"-thick
- Wood doors are 1/4"-thick,
- Metal doors are 5/16"-thick
- Glass door is back-painted low-iron glass
- Glass door is square, and does not have the "file folder" design like the metal and wood Power Matrix doors
- Interior body is clear anodized aluminum
- Each unit includes a 15 amp, 12' power infeed (plug in only)
- If Field-Wired option is specified, each unit includes a 6' flexible metal conduit and requires a hardwire connection
- Standard configuration: Eight simplex receptacles, eight RJ-45 data connectors and eight single blank faceplates
- Additional data/AV faceplate options are on page 81

REQUIRED INFORMATION: (ORDER CANNOT BE ENTERED WITHOUT THIS INFORMATION)

See appendix pages vi-vii for surface material options.

- Choose location code & quantity from the charts on pages 14-19
- Choose Glass Door Finish, if glass door version is specified
- Choose Metal Finish, if metal door version is specified or for the bezel finish on laminate tables



POWER AND DATA OPTIONS

SINGLE INFEED OPTION	MODEL #	DESCRIPTION	PRICE
	SI-H	Single In-Feed Option, Hard-wired	553
	SI-C	Single In-Feed Option, Corded (Plug-in)	668

GENERAL INFORMATION

- Tables 72"-120" in length include 2 duplex receptacles with the modular power system
- Tables 132"-240" in length include 3 duplex receptacles with the modular power system
- Hardwired and Corded Single Infeed options are 7' long
- Single Infeed option cannot be specified in conjunction with the Field-Wired (-FW) option
- Corded Single Infeed option will require a 20-amp power outlet in the floor monument and reduces the modular electrical system in the table to a single circuit

RETRACTORS	MODEL #	DESCRIPTION	PRICE
	CR-CAT6	CAT6 Retractor	907
	CR-HDMI	HDMI Retractor	907
	CR-DISPLAY	Display Port Retractor	907
	CR-USB	Data USB Retractor	907

GENERAL INFORMATION

- Mounting bracket and attaching hardware included with each retractor
- Can only be used with Power Matrix Small or Medium units
- Not available on round tables
- One Cable Pass Through Set (one top, one bottom) AAP FLDF-14 included. Double style AAP
- See page 23 for availability by table size

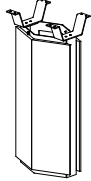
WIRE CHASE	MODEL #	DIMENSIONS	VENEER -V	PAINTED -P
	ACSB	12.5 x 7.5	1,013	962

GENERAL INFORMATION

- Wire Chase option to be used with two base tables (not for structural support)
- May be specified on tables 96"-144" L
- Wire Management opening is 6" x 7"
- Wire Chase is located perpendicular to the base locations (see page 38 for location illustration)

REQUIRED INFORMATION: (ORDER CANNOT BE ENTERED WITHOUT THIS INFORMATION)

See appendix pages vi-vii for surface material options.

- Choose Veneer Finish, if applicable
- Choose Paint Finish, if applicable



POWER AND DATA OPTIONS

HARDWIRE INFEED POWER RAIL KIT	MODEL #	TOTAL # OF RAILS	ELECTRICAL OUTLETS	(2) SIMPLEX -S2	ELECTRICAL OUTLETS	(1) SIMPLEX / (1) CHARGING USB -S3
(Includes Power Rails, Hardwire Infeed and Modular Power Components)	AC-RAIL-1-H	1	2	1,331	1	1,331
	AC-RAIL-2-H	2	4	2,114	2	2,114
	AC-RAIL-3-H	3	6	2,895	3	2,895
	AC-RAIL-4-H	4	8	3,677	4	3,677
	AC-RAIL-5-H	5	10	4,459	5	4,459
	AC-RAIL-6-H	6	12	5,239	6	5,239
	AC-RAIL-7-H	7	14	6,019	7	6,019
	AC-RAIL-8-H	8	16	6,800	8	6,800
	AC-RAIL-9-H	9	18	7,583	9	7,583
	AC-RAIL-10-H	10	20	8,365	10	8,365
	AC-RAIL-11-H	11	22	9,145	11	9,145
	AC-RAIL-12-H	12	24	9,926	12	9,926

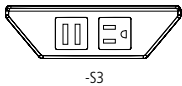
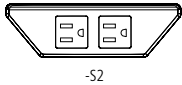

GENERAL INFORMATION

- Includes modular power electrical system
- Hardwire infeed is 7" long
- Not available on Stone Top tables
- Maximum of 12 Power Rails per table
- Simplex receptacles will be white, when Burnished, Cloud or Foil powdercoat finishes are specified. Black simplex receptacles will be used for all other powdercoat finishes.
- Power Rails not available in Clear or Black Anodized

REQUIRED INFORMATION: (ORDER CANNOT BE ENTERED WITHOUT THIS INFORMATION)

- See appendix pages vi-vii for surface material options.
- Choose Metal Finish

CORDED INFEED POWER RAIL KIT	MODEL #	TOTAL # OF RAILS	ELECTRICAL OUTLETS	(2) SIMPLEX -S2	ELECTRICAL OUTLETS	(1) SIMPLEX / (1) CHARGING USB -S3
(Includes Power Rails, Corded Infeed and Modular Power Components)	AC-RAIL-1-C	1	2	1,448	1	1,448
	AC-RAIL-2-C	2	4	2,232	2	2,232
	AC-RAIL-3-C	3	6	3,012	3	3,012
	AC-RAIL-4-C	4	8	3,792	4	3,792
	AC-RAIL-5-C	5	10	4,573	5	4,573
	AC-RAIL-6-C	6	12	5,357	6	5,357
	AC-RAIL-7-C	7	14	6,138	7	6,138
	AC-RAIL-8-C	8	16	6,918	8	6,918
	AC-RAIL-9-C	9	18	7,699	9	7,699
	AC-RAIL-10-C	10	20	8,481	10	8,481
	AC-RAIL-11-C	11	22	9,264	11	9,264
	AC-RAIL-12-C	12	24	10,044	12	10,044

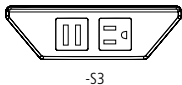
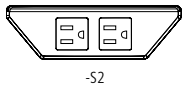

GENERAL INFORMATION

- Not available on Stone Top tables
- Data rails do not count toward the maximum of 12 Power Rails per table. For information on how many Data Rails a specific table size can accommodate, please contact Nucraft Customer Service.
- Data Rails not available in Clear or Black Anodized

REQUIRED INFORMATION: (ORDER CANNOT BE ENTERED WITHOUT THIS INFORMATION)

- See appendix pages vi-vii for surface material options.
- Choose Metal Finish



POWER AND DATA OPTIONS

DATA RAIL	MODEL #	DESCRIPTION	PRICE
 AC-RAIL-DATA	AC-RAIL-DATA	Data Rail includes (1) blank faceplate and (1) dual RJ-45 faceplate	604

- GENERAL INFORMATION**
- Not available on Stone Top tables
 - Data rails do not count toward the maximum of 12 Power Rails per table. For information on how many Data Rails a specific table size can accommodate, please contact Nucraft Customer Service.
 - Data Rails not available in Clear or Black Anodized

REQUIRED INFORMATION: (ORDER CANNOT BE ENTERED WITHOUT THIS INFORMATION)
 See appendix pages vi-vii for surface material options.
 ▪ Choose Metal Finish

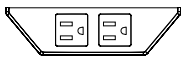
FIELD-WIRED	MODEL #	DESCRIPTION	(2) SIMPLEX -S2	(1) SIMPLEX / (1) CHARGING USB -S3
 -S2	AC-RAIL-FW	Field-Wired Power Rail	696	696

- GENERAL INFORMATION**
- Includes 6' flexible metal conduit and required a hardwire connection
 - Not available on Stone Top tables
 - Maximum of 12 Power Rails per table
 - May be required in New York City, Chicago and San Francisco. Check with an electrician for local codes and requirements. A junction box will be provided when ordering the FW-RAIL-FW option.
 - Power Rails not available in Clear or Black Anodized

REQUIRED INFORMATION: (ORDER CANNOT BE ENTERED WITHOUT THIS INFORMATION)
 See appendix pages vi-vii for surface material options.
 ▪ Choose Metal Finish

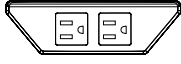
INDIVIDUAL POWER RAIL	MODEL #	DESCRIPTION	(2) SIMPLEX -S2	(1) SIMPLEX / (1) CHARGING USB -S3
 -S2	AC-RAIL	Power Rail	784	784

- GENERAL INFORMATION**
- Individual power rails do not include a modular power system. Each Power Rail must directly plug into a floor core with a 6'-corded 15-amp plug-in infeed. (Typically used with smaller tables, rounds, squares, soft squares, where a modular power system is not required.)
 - Not available on Stone Top tables
 - Maximum of 12 Power Rails per table
 - Simplex receptacles will be white, when Burnished, Cloud or Foil powdercoat finishes are specified. Black simplex receptacles will be used for all other powdercoat finishes.
 - Power Rails not available in Clear or Black Anodized

REQUIRED INFORMATION: (ORDER CANNOT BE ENTERED WITHOUT THIS INFORMATION)
 See appendix pages vi-vii for surface material options.
 ▪ Choose Metal Finish



POWER AND DATA OPTIONS

DATA FACEPLATES	MODEL #	DESCRIPTION	STYLE	W x H	PRICE
	FLDF-1	Blank faceplate, single height	Single	3-1/2 x 5/8	74
	FLDF-2	One VGA 15-pin HD Female to Female Gender Changer, one 3.5mm Stereo Mini Jack to Solder Tabs	Single	3-1/2 x 5/8	259
	FLDF-3	One VGA 15-pin HD Female to Female Gender Changer	Single	3-1/2 x 5/8	203
	FLDF-4	One RJ-11 Female to Punch Down - Phone	Single	3-1/2 x 5/8	203
	FLDF-5	One RJ-45 Female to Female Barrel - Data	Single	3-1/2 x 5/8	166
	FLDF-6	Two RJ-45 Female to Female Barrels, single height	Single	3-1/2 x 5/8	223
	FLDF-7	Two RJ-45 Female to Punch Down for CAT 6 - AMP	Single	3-1/2 x 5/8	315
	FLDF-8	Two RJ-45 Female to Punch Down for CAT 6 - Leviton	Single	3-1/2 x 5/8	315
	FLDF-10	Two RJ-45 Female to Punch Down for CAT 6 - Panduit	Single	3-1/2 x 5/8	315
	FLDF-11	Two USB A Female to Two USB A Female on 10" Pigtails	Single	3-1/2 x 5/8	352
	FLDF-12	Blank faceplate, double height	Double	3-1/2 x 1-3/8	92
	FLDF-13	Two RJ-45 Female to Female Barrels, double height	Double	3-1/2 x 1-3/8	223
	FLDF-14	Cable Pass-Through Set - one top, one bottom	Double	3-1/2 x 1-3/8	389
	FLDF-15	One HDMI Female to Female Barrel	Single	3-1/2 x 5/8	259

GENERAL INFORMATION

- All connectors and faceplates are Extron® Architectural Adapter Plates (AAP)
- Each FW-RAIL-DATA unit holds two Single Space faceplates
- Faceplates are black

TWO PORT POWER CAP	MODEL #	DESCRIPTION	W x D	SIMPLEX OUTLETS	USB-A+C	DATA	ONE UNIT (CENTERED) -1
For use with Column Base	ACC-SU-B-C-[]	Black Simplex	5 x 5	1	1	-	1,137
	ACC-SU-W-C-[]	White Simplex	5 x 5	1	1	-	1,137
	ACC-SS-B-[]	Black Simplex	5 x 5	2	-	-	976
	ACC-SS-W-[]	White Simplex	5 x 5	2	-	-	976

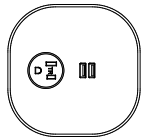

ACC-SU

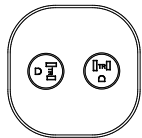

ACC-SS

OPTIONS

OPTIONS	CODE	PRICE	NOTES
Polished Chrome Plate	Add -PCP	\$70 per unit	
Field-Wired	Add -FW	Add \$97 per unit	May be required in New York City, Chicago and San Francisco. Check with an electrician for local codes and requirements.

GENERAL INFORMATION

- Available on Round Tops with Column Base only
- Available at center location only

REQUIRED INFORMATION: (ORDER CANNOT BE ENTERED WITHOUT THIS INFORMATION)

- See appendix pages vi-vii for surface material options.
- Choose Metal Finish (unless Polished Chrome has been specified)

GROMMET	MODEL #	DESCRIPTION	DIAMETER	PRICE
	GR	Round Grommet	2" Dia	220



OPTIONS

OPTIONS	CODE	PRICE	NOTES
Polished Chrome Grommet	Add -PCG	\$86 per unit	

GENERAL INFORMATION

- Available on Round Tops with Column Base only
- Available at center location only

REQUIRED INFORMATION: (ORDER CANNOT BE ENTERED WITHOUT THIS INFORMATION)

- See appendix pages vi-vii for surface material options.
- Choose Metal Finish: Powder Coat, Clear Anodized or Polished Chrome (upcharge applies)



FREESTANDING POWER OPTION

TECH ZONE	MODEL #	DESCRIPTION	SIMPLEX OUTLETS	OPEN DATA PORTS	CHARGING USB-A+C	PRICE
	ZONE-DATA	(2) Simplex receptacles, (2) Open data ports	2	2	-	341
	ZONE-USB-C	(2) Simplex receptacles, (1) Charging USB-A+C, (1) Open data port	2	1	1	408

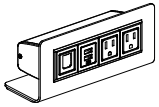

ZONE-USB-C



ZONE-DATA



ZONE-USB-C

GENERAL INFORMATION

- 72" long plug-in infeed cord
- Finish is black
- Includes a Voice/Data Adapter Kit to accept couplers and jacks when required



Appendix



GENERAL INFORMATION

This price book supercedes all previous versions.

Before placing your order, confirm you have all required information necessary. Lead times for orders begin after all required information is included and correct.

Delivery Information

We know lead times are important and sticking to them even more so. We work to maintain a 6-8 week lead time on all standard products in this book from receipt of a clean order. All orders are acknowledged with an approximate shipping date and will be invoiced with the price in effect at the date the purchase order is received.

Shipping charges are prepaid (within the continental U.S.). Therefore, pricing is a delivered price based on normal ground transportation. If you have special instructions, need to ship by air, or are shipping to Alaska or Hawaii, contact Nucraft Customer Service. Nucraft can also help arrange to have products blanket wrapped for an additional charge. Contact the Nucraft Customer Service team or specify it on your purchase order.

Minimum Freight Charge: Any order below \$2,800 net will be assessed a \$450 net minimum freight charge (one per order).

Orders are subject to acquiring the materials required for manufacturing. Fulfillment can be affected by strikes, fires, embargoes and acts of government. These elements are beyond our control.

Nucraft offers a variety of services to accommodate a wide range of delivery requirements. Availability of these services is dependent on a number of factors and may not be offered with all shipments. Examples of delivery services that have additional fees include:

- Specific date within our standard 3-5 day delivery window (for orders under \$50,000 net)
- Specific time of day, morning or afternoon (for orders under \$50,000 net)
- Delivery to a warehouse before delivery to its final destination (unless product is picked up at the warehouse)

Contact the Nucraft Customer Service team for availability and pricing on these services.

Freight Terms

Shipping charges for Nucraft products are prepaid for standard delivery in the continental United States. Standard delivery is defined as follows: Product is delivered on a 53' trailer being pulled by a long-haul tractor (total length of 85'). Facility will receive delivery Monday through Friday between the hours of 8:00 AM and 4:00 PM. Facility has docks with levelers and a fork truck for unloading. Product will be loaded on load bars two levels high. Receiving facility is responsible to have personnel on hand to unload the truck upon arrival, drivers do not unload. Delivery sites or times that do not meet this criteria will be accommodated, but will typically incur a charge to cover additional shipping costs. Please notify Nucraft in advance of the shipment if this is the case and the additional charge (if any) will be determined by Nucraft.

Product ships FOB dock. The customer obtains title to their product and materials, and assumes the risk of loss for them, upon shipment from Nucraft's facilities.

Storage

Nucraft has no storage facilities for finished product. If a customer cannot accept an order when it is ready for shipment, the customer must designate an alternative shipping address. If no address is provided, Nucraft may, at its discretion, transfer the product to storage. If product is transferred to an off-site storage facility, the customer may be charged for transportation to the facility and for any associated storage fees. Nucraft considers transfer of the product to a storage facility the equivalent of shipment, including invoicing and payment. Customers assume the risk of damage or loss during storage.

Transportation Times and Delays

Third party carriers that Nucraft contracts with will make reasonable efforts to accommodate requested delivery times and dates. Scheduled delivery appointments may, however, be delayed for a variety of reasons, including inclement weather, traffic, transportation equipment problems, and delays encountered at other delivery locations along the delivery route. Nucraft does not recommend scheduling activities that depend on the delivery appointment (for example, scheduling furniture installers to install furniture the day of the delivery appointment). Nucraft shall not be liable for any costs incurred as a result of a missed delivery appointment.

Shipment Damage Claims

Legal title to merchandise passes to the buyer upon acceptance by the carrier. **Inspect all cartons upon delivery.** Details of visible damage should be noted on the delivery receipt. Do not install product if damage is found upon inspection. The carrier should be notified by the buyer to inspect the merchandise, and file a claim immediately. If visible damage is not apparent, sign the delivery receipt "No visible damage." This will allow recourse for a concealed damage claim. Although most claims for transportation damages must be filed against the carrier within nine months of the date of delivery, concealed damage claims must be filed within 15 days of receipt.

Do not destroy packing materials until shipment has been inspected. Then proceed to file a claim with the carrier.

Failure to make any claims against Nucraft within 10 days shall constitute acceptance of the merchandise and a waiver of any defects, errors or shortages discovered upon inspection.

Cancellations

Cancellations must be reviewed by our Customer Service team. Because we build your products to order, orders cannot be cancelled once processing has begun. Processing includes but is not limited to development of shop drawings and other engineering drawings. If cancellation is approved, a processing fee of 20-100% will be assessed based on the status of the order.

Change Order Policy

Nucraft will make every attempt to honor any reasonable change request to product provided that the request is received prior to start of production. Change orders will be accepted only if the request is made in writing and received in time to make the change. Nucraft reserves the right to increase our acknowledged price and ship date if necessary to make the requested changes. Please submit any change order request to our Customer Service team. Nucraft will assess charges to the customer as stipulated in the following:

- Standard Orders: Change orders received prior to production will be charged \$400 net to cover administrative costs.
- Special Orders: Change orders received prior to production will be charged \$400 net to cover administrative costs. There may be additional costs associated with engineering labor required for the change order.
- Change orders received after production must be evaluated by Nucraft. If approved, the charge will be \$400 net plus any restocking charges accumulated. There may be additional costs associated with engineering and/or manufacturing labor, as well as material costs, required for the change order.



GENERAL INFORMATION

Repair Authorization

Prior written approval is required for repairs of merchandise charged to NuCraft. Failure to do so will result in customer funded repairs.

Payment Terms

Deposits are required at the time of order due to the custom nature of our products. See information regarding Cancellations above.

Credit terms are available to qualified customers. Please contact AR@NuCraft.com to start the application process. Note that the credit application process requires a valid sales tax exemption or resale tax certificate, Form W-9, and three current trade references.

Credit Card Payments are accepted via web portal. Please contact AR@NuCraft.com for payment instructions. Note that a 2% convenience fee will be added for using this payment method and no early pay discounts are allowed on credit card payments.

Warranty

NuCraft Furniture is warranted to be free from defects in materials and workmanship for a period of ten years of single shift use. Limitations include:

- Mechanical Devices such as latches, casters, and other moving components are warranted for five years of the date of original delivery.
- Height adjustable components are warranted for two years of the date of original delivery.
- The following are warranted for one year of the date of original delivery:
 - Textiles
 - Electrical Components
 - Refrigeration Units
 - Custom Products not described in NuCraft's Catalogue

This warranty is applicable only if furniture is properly installed and maintained in an office environment. This warranty extends only to products manufactured and sold in North America and only to original purchasers acquiring new NuCraft product through authorized dealers or approved sellers.

During this warranty period, NuCraft's sole obligation is to repair or replace, at NuCraft's discretion, products which prove to be defective during the warranty period.

This warranty does not cover:

- Damage caused by a carrier.
- Damage from user modification, misuse, abuse, accident, or negligence.
- Customer's Own Material (COM) specified by the customer that is not a standard product offering.
- Color, grain, or texture of wood and other covering material.

NuCraft extends no other warranties, expressed or implied, including warranty of merchantability or fitness for a particular purpose. NuCraft shall not be liable for loss of time, inconvenience, commercial loss, incidental or consequential damages.

Environmental Statement

NuCraft is committed to supporting responsible environmental policies and practices in all that we do. We strive for sustainability, weighing our business decisions against the costs to the ecological, social and economic systems they affect.

Our products are manufactured to meet the credit requirements of the U.S. Green Building Council's LEED rating systems in one or more of the following categories:

- Recycled Content
- Certified Wood
- Low-Emitting Materials

Computer Aided Planning

NuCraft products and pricing are available on CD via 2020 Cap, an AutoCAD®-based space planning tool.

2020 Cap is an integrated software system developed specifically for interior designers and facility planners to enhance workplace performance. This modern suite of applications works together seamlessly, in concert. Navigate catalogs, select products, design in plan view and 3D, assign options, create worksheets and build a project where you want, when you want. Take your pick. It's dynamic and interactive. Design projects are a work in progress. And now you can perform any of the many discrete tasks that go into a project any time, any place.

For additional information, you may contact 2020 Cap direct at 800-227-0038.

iSpec®

NuCraft offers a free online product configuration and specification service that saves you time and allows you to be creative while leaving the nuts and bolts to someone else. No specific software is required, nor is there any learning curve. This service applies to all NuCraft products. For additional information, call 1-877-NUCRAFT and ask for the iSpec Team or log on to www.nucraft.com/ispec.



FINISH INFORMATION

Surface Materials Palette

We crafted our materials palette using the same demanding standards that distinguish our furniture. Thoughtful design and attention to every detail elevate your possibilities.

Anchored by NuCraft veneers, unrivaled for clarity, quality, and depth of finish, our collection of surface materials comprises a sophisticated set of balanced elements that supports your design vision.

Some elements have their roots in NuCraft’s rich heritage. Others are new materials and reflect current trends and taste. Together, they ensure that you’re ready for today and positioned well for the future. Beautifully.

Custom Finishes

NuCraft specializes in expert custom finish matching. For a nominal upcharge we can provide custom finishes, and we are frequently asked to match the finishes of other furniture manufacturers. For finishes that appear unusual to match or for customers directly requesting a sample, a finish sample will be sent for approval prior to entering the order.

Custom finishes requiring colored varnishes to create a painted look can only be applied to Maple veneer and require one extra week in addition to the standard lead time. NuCraft’s standard black finish (G82) can be applied to all NuCraft standard veneers. Walnut is the standard black veneer. Other species must be specified when ordering.

Clear coat on a special veneer requires an approved sample.

Custom finishes carry a 10% upcharge per item, per finish, capped at \$1,975 List.

Custom finish upcharges are not applied to any item that is not wood. Example: casters, ganging connectors, power options..

Treatments

Note: Default veneer sheen will vary per finish and product. Default finish is bolded on pages vi-vii. If no direction is provided on incoming orders, default sheen will be selected. In addition, default veneer cut is noted in the price list. If no direction is provided on incoming orders, default cut will be selected.

Gloss: Gloss is a durable finish that tends to nicely mask normal wear and leaves wood grain visible to the eye. It achieves a medium gloss open pore appearance (40 – 50 sheen range). Finish numbers preceded by the letter “G” indicate a Gloss finish.

Matte: Like Gloss, Matte is durable, tends to nicely mask normal wear and leaves wood grain visible to the eye. It achieves a low luster, open pore appearance (10 – 20 sheen range). Finish numbers preceded by the letter “M” indicate a Matte finish.

Since each veneer type responds differently to both types of treatment, all will have a distinctive look and feel when finished. For example, a Walnut veneer with a Gloss treatment will remain much more textured than a Cherry veneer with the same treatment.

About the Wood

All NuCraft veneers are carefully selected for uniformity of color and grain. Still, wood is a natural substance and minor variations may occur due to its own uniqueness. Because of this, the furniture you receive may not be an exact match to our samples.

NuCraft takes great pride in our finish color consistency. However, wood is a natural product that will have color variation within a single piece of furniture, as well as from one piece to the next. Other factors also affect color over time, such as exposure to light (both intensity and duration). For example, lighter finishes cause more variation in colors over time.

In cases where a returning customer wants a precise match with existing furniture, we recommend sending a sample of the existing furniture finish. Please contact NuCraft Customer Service to determine an appropriate sample. This will ensure a finish match between old and new orders. This type of order is considered a control sample. There will be a 10% upcharge on an order of this type. Due to natural aging of veneers, natural finishes may vary.

Care and Maintenance of Wood Finishes

Our finish material is a crystal clear, urethane acrylic blend. This type of finish may be repaired in the field by a qualified refinisher.

NuCraft recommends using a damp cloth to clean your fine wood furniture. Always wipe with the grain of the wood. Should your wood furniture require a more thorough cleaning, we recommend using a mild cleaner such as Joy dish soap or Murphy’s oil soap, thoroughly diluted in water (one part soap to thirty parts water). Water will not damage NuCraft’s finish, but it may leave surface spots when it dries. To avoid this, dry the surface with a soft cloth after it is cleaned. Marks that cannot be removed with the cleaning methods above may be able to be removed using naphtha, a mild degreasing solvent.

Caution: while the use of polishes that contain wax, petroleum solvents or silicones may immediately enhance the “shine” of a product, it may also eventually remove the fine original finish applied in our factory. Silicone on the surface of wood may also make it very difficult to respray or refinish.

All NuCraft furniture is inspected and polished before it leaves our factory. In some instances, the packing materials may imprint on the factory polish. Cleaning and polishing the furniture once it is unpacked will normally restore the furniture to its original beauty.

In some cases, the rubber support feet used on the bottom of common office equipment (teleconferencing phones, laptops, microphones, copiers, etc.) can create unsightly marks in the surface of wood tops, due to oxidation of the lacquer finish. We suggest these machines be placed on a protective type of padding, such as felt.

Wood will fade as a result of exposure to UV light. This is particularly prevalent with light finishes. If color changes due to fading are a concern for your application, the impact can be minimized by selecting medium to dark stains for your wood surfaces. Our top coat includes a UV inhibitor which makes the finishes less prone to fading.



FINISH INFORMATION

Laminates

Selected Formica® and Nevamar® laminates are available on Training Tables, Conference Tables, Conference Room Furniture and select Occasional Tables. For standard laminate and wood pricing, refer to individual item pricing columns.

Non-Standard Laminates and Linoleums

To order a color other than those on our list (see pages vi-vii), refer to Nevamar or Formica standard grade, matte texture laminate offerings and Forbo Furniture Linoleums (excluding manufacturers' non-standard matte offering).

- For approved non-standard laminates with a hardwood edge, the upcharge is 10% of the base price per laminate color with a minimum of \$500 and capped at \$1975.
- For approved non-standard laminate with a standard ABS edge, the upcharge is \$175 per laminate color.
- For approved non-standard laminates with a non standard ABS edge, please contact customer service.

To ensure your non standard laminate is on our approved list, please contact customer service. Add one week to the lead-time for all non-standard laminate and linoleum orders. Call the Nucraft Customer Service team for quotes on premium grades and laminates. Mirror and metal laminates are not available.

Care and Maintenance of Laminate and Novawrap

Laminate and Novawrap surfaces may be cleaned with a damp cloth and ordinary soap or non-abrasive household liquid detergent. Dry the surface with a clean cloth or soft paper towel to prevent streaks from appearing.

Care and Maintenance of Metal

Metal surfaces can be wiped with a damp cloth and rubbed dry. A mild non-abrasive household liquid detergent can be used if necessary. Regular maintenance of metal components, including tightening of fasteners and light lubrication of moving parts, will extend the life of your furniture.

Satin Etched Glass

Glass color may vary slightly on multi-piece conference table tops over 180" x 60" when satin etched glass is specified due to the iron content and etching process of the glass.

Care and Maintenance of Glass

Clear or frosted glass may be cleaned with commercial glass cleaner. Be sure to use a lint-free cloth if cleaning the frosted side of the glass.

Stone and Solid Surface Material

Despite its reputation for durability, natural stone can easily be broken during handling and/or installation if proper techniques are not followed. In addition, Nucraft is not responsible for the installation of natural stone or solid surface materials on its products. Therefore, installers specifically trained in the installation of these materials must be utilized to ensure a quality installation. Nucraft shall not be liable for any damages incurred during the handling and/or installation of natural stone or solid surface materials on its products.

Care and Maintenance of Granite

Granite surfaces may be cleaned with a damp cloth and ordinary soap or non-abrasive household liquid detergent. Dry the surface with a clean cloth or soft paper towel to prevent streaks from appearing.

Care and Maintenance of Leather

Genuine leather requires very little care. Nucraft recommends that leather be dusted regularly. If a more thorough cleaning is needed, use lukewarm water and a mild, non-abrasive soap. Generate some lather and lightly rub the surface with cheesecloth. Rinse off any soap film with clean water and towel dry. The leather may dry dull. To restore the leather to a normal gloss, rub it with a clean towel. Never use furniture polish, oil, varnish or ammonia. Saddle soap may be used to prevent the leather from becoming brittle or cracked and to maintain the original supple finish.

Touch Up Finish Kits

Model #	Description	Price
KIT-M	Metal Kit	80
KIT-P	Paint Kit	80
KIT-S	Stain Kit	80

REQUIRED INFORMATION: (ORDER CANNOT BE ENTERED WITHOUT THIS INFORMATION)

- Kit model number
- Quantity of kits
- Specify finish (See pages vi-vii)

General Information:

- Touch-up kits must be ordered on a purchase order separate from Nucraft product due to Hazmat shipping



ASCARI CONFERENCE SURFACE MATERIALS

WOOD FINISHES

STANDARD

Default veneer sheen will vary per finish and were determined by a team of experts who reviewed the colorways to determine if gloss or matte best highlighted the natural characteristics of the species of wood and the color of the stain. Default finish is bolded. If no direction is provided, default sheen will be selected.

	Matte	Gloss
Ash		
Blanco	M44	G44
Char	M50	G50

Rift Cut Oak

Carbon	M03	G03
--------	-----	------------

Flat Cut Oak

Dune	M05	G05
Portobello	M7413	G7413

Flaky Oak

Sahara	M61	G61
--------	------------	-----

Cherry

Cognac	M21	G21
Auburn	M93	G93

Walnut

Marron	M35	G35
Mocha	M33	G33
Zinc	M30	G30
Onyx	M82	G82
Otter	M31	G31

Maple

Natural Maple	M60	G60
---------------	-----	------------

Linea

Oak Linea	M08	G08
Walnut Linea	M27	G27
Euro Birch Linea	M09	G09
Silver Birch Linea	M10	G10

Paldaos

Thicket	M75	G75
Paldaos	M76	G76
Canyon	M77	G77

METAL FINISHES

Powder Coat

Aged Bronze	A8010
Black	A44
Burnished	A8009
Cloud	A8004
Foil	A8006
Galaxy	A8007
Satin Bronze	A8011
Shadow	A8005
Storm	A8012

Metal

Brushed Stainless*	BSS
Clear Anodized*	CA
Polished Stainless*	APS
Satin Bronze Plating*	SBP

*Up-Charge applies.

PAINTS

Aged Bronze	S8010
Black	S44
Burnished	S88
Cloud	S8004
Foil	S8006
Galaxy	S8007
Moonlight	S87
Satin Bronze	S8011
Shadow	S8005
Storm	S8012

Paint to Match

To request a custom paint color, contact Nucraft Customer Service. A paint sample must be matched and approved prior to order.



ASCARI CONFERENCE SURFACE MATERIALS

STONE TOPS

Stone orders may affect lead times. Please contact NuCraft Customer Service for details.

		Subtop Paint Color
Quartz Cambria® Signature		
Ainsley	STC100	S8004
Armitage	STC101	S44
Bellingham	STC102	S8004
Berkeley	STC103	S8004
Berwyn	STC104	S8004
Blackbrook	STC105	S44
Bradshaw	STC106	S8004
Bradwell	STC107	S8004
Cambria Black	STC109	S44
Carrick	STC110	S44
Clifton	STC112	S8004
Colton	STC113	S8004
Crowndale	STC114	S8004
Devon	STC115	S44
Fairbourne	STC116	S8004
Fieldstone	STC117	S44
Halewood	STC119	S8004
Hermitage	STC120	S8004
Highgate	STC121	S8004
Kendal	STC122	S8004
Laneshaw	STC124	S44
Malvern	STC125	S8004
Montgomery	STC128	S8004
Nevern	STC129	S8004
New Quay	STC130	S8004
Pendle Hill	STC131	S8004
Praa Sands	STC132	S8004
Rose Bay	STC133	S8004
Sandgate	STC135	S8004
Smithfield	STC136	S8004
Summerhill	STC137	S8004
Sutherland	STC138	S8004
Swanbridge	STC139	S8004
Torquay	STC140	S8004
Travella	STC141	S8004
Weybourne	STC143	S8004
Whitney	STC144	S8004
Woodcroft	STC146	S44

Quartz | Cambria® Luxury

Abbey	STC147	S8004
Annicca	STC148	S8004
Baybridge	STC149	S8004
Beckington	STC150	S8004
Bentley	STC151	S8004
Blackpool Matte	STC152	S44
Brittanicca	STC153	S8004
Brittanicca Gold Cool	STC154	S8004
Brittanicca Gold Warm	STC155	S8004
Brittanicca Warm	STC156	S8004
Clovelly	STC158	S8004
Delamere	STC159	S44
Delgatie	STC160	S8004
Ella	STC161	S8004
Everleigh	STC162	S8004
Gladstone	STC163	S8004
Golden Dragon	STC164	S44
Hailey	STC165	S8004
Harlow	STC166	S8004
Hemsworth	STC167	S8004
Huntley	STC168	S8004
Inverness Bristol Bay	STC169	S8004
Inverness Bronze	STC170	S8004
Inverness Cobalt	STC171	S8004
Inverness Everleigh	STC172	S8004
Inverness Platinum	STC173	S8004
Inverness Swansea	STC174	S8004
Ironsbridge	STC175	S8004
Iverness Frost	STC176	S8004
Iverness Gold	STC177	S8004
Ivybridge	STC178	S8004
Lakedale	STC179	S8004
Mayfair	STC181	S8004
Mersey	STC182	S44
Notting Hill	STC183	S8004
Oakleigh	STC184	S8004
Portrush	STC185	S8004
Queen Anne	STC186	S8006
Skara Brae	STC187	S8004
Southport	STC188	S8004
White Cliff	STC189	S8004

Quartz | Wilsonart

Carrara Codena	ST21	S8004
Serene	ST17	S8004

Stone

Absolute Black Honed Granite	ST01	S8007
Carrara Marble	ST16	S8004



ASCARI CONFERENCE SURFACE MATERIALS

GLASS (SATIN OR GLOSS)

	Satin	Gloss
Black	BS	-
Clove	VS	VG
Meringue	MS	MG
Quill	QS	QG
White	WS	WG

Note: Due to color variation inherent in the natural acid etching process, Satin Etched Glass is not available on tables longer than 180" or wider than 60"

CHEMETAL

Available on base reveal

Light Stainless Aluminum	927
Brushed Golden Aluminum	931

FENIX

	Code	Matching ABS Edgeband
Bianco Kos	0032	962091-017
Grigio Bromo	0724	962091-012
Nero Ingo	0720	962091-003
Grigio Efeso	0725	962091-013

LAMINATES

	Code	Coordinating Wood Finish	Suggested ABS Edgeband Coordinate
Wood Grain Laminates[§]			
Formica White Ash	8841-58	M8841	R02, R01
Formica Natural Ash	8843-58	M8843	R02
Formica Aged Ash	8844-58	M8844	R04
Formica Weathered Ash	8842-58	M8842	R05
Formica Oiled Legno	8846-58	M8846	R05
Formica Bleached Legno	8845-58	M8845	R04
Formica Blackened Legno	8848-58	M8848	R05
Formica Urban Planked Oak	9312-58	M9312	R04
Formica Thermo Walnut	6402-58	M6402	R04
Formica Smoky Brown Pear	5488-58	M5488	R05
Formica Espresso Pear	5489-58	M5489	R05
Formica White Knotty Maple	7410-58	M7410	R02
Formica Sand Maple	9237-58	G60	R02
Formica Planked Coffee Oak	7413-58	M7413	R05

[§]Not available on multiple piece conference tables

Wood Grain Laminates Suitable for Multiple Piece Conference Tables

Formica Pecan Woodline	5883-58	M5883	R04
Formica Chestnut Woodline	5884-58	M5884	R05

Solid Laminates

Formica Brite White	459-58	R01
Formica Dover White	7197-58	R01
Formica Pearl	934-58	R02
Formica Graystone	464-58	R02
Formica Folkstone	927-58	R03
Formica Graphite	837-58	R05

Patterned Laminates

Nevamar Cool Chic	VA7002T	R02
Nevamar Serene Stardom	VA5001T	R05
Nevamar Calm Distinction	VA6001T	R05
Nevamar Easy Elegance	VA5002T	R05
Wilsonart Sheer Mesh	4876-38	R02
Wilsonart Grey Mesh	4877-38	R02
Wilsonart Pewter Mesh	4878-38	R05

ABS FINISHES

Ashen	R04
Parchment	R02
Shale	R05
Stone	R03
Whitecap	R01