

ATIVA[®]

GSA Planning Guide + Price List

QUICK LINKS

[PLANNING GUIDE](#)

[ATIVA PRICING](#)

[GENERAL INFORMATION](#)

[FINISH INFORMATION](#)

[SURFACE MATERIALS](#)



TABLE OF CONTENTS

Click the shortcuts below to jump to each section.

General Information	ii-iii
Finish Information	iv-v
Surface Materials	vi
Statement of Line	3
Specification Overview	4
Planning Guide	5-18
Enclosed Square and Rectangle Tables	19-26
U-Shape Tables	27-34

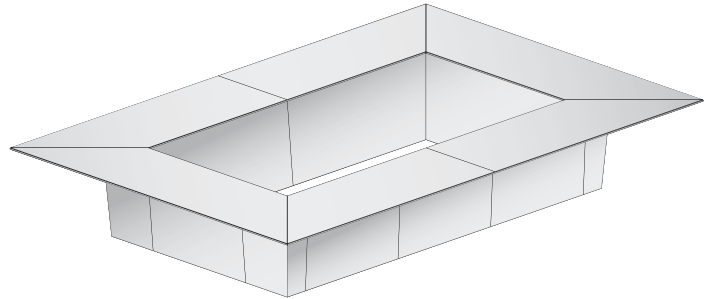



STATEMENT OF LINE

TABLES

Pages 19-34

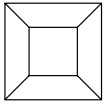

Square

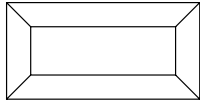

Rectangle

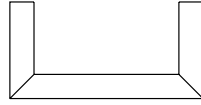

Wide U-shape

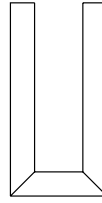

Narrow U-shape



SPECIFICATION OVERVIEW

1. Select the Table Shape

Ativa is available in four shapes; Square, Rectangle, Narrow U-shape and Wide U-shape.

2. Select the Size (Length and Width)

Ativa is available in 12" increments from 96" to 240" and 24" increments from 240" to 360".

3. Select Power Option (if desired)

Power Matrix provides easy table top accessibility and voice/data connections in a small footprint. Doors are available in metal, glass and grain-matched wood. The interior is anodized aluminum.

4. Select the Surface Material Finishes



DETAIL OVERVIEW

METAL TRIM

1/8”-wide metal trim pieces, recessed 1/8”, are located at all corners, both in the table tops and the modesty panels, creating a subtle yet elegant design detail.

MODESTY PANEL

Located on the inside of the table, these full-height veneer panels feature a sequentially matched, full cut veneer layup for an enhanced aesthetic.

ACCESS PANELS

These removable panels allow clear and unfettered access to the hollow section of the Modesty Wall (see page 7) for easy technology installation and wiring. Access Panels feature quarter cut veneers, allowing them to be placed in any location around the table. One Access Panel per table includes a cutout in the bottom to allow access into the hollow section of the Modesty Wall for conduit and other cables should the floor monument fall outside the footprint of the Modesty Wall (toward the user’s side).

ACCESS DOOR

Provides access to the inside of a fully enclosed configuration for cleaning or to retrieve items that may have fallen into this area.

SEQUENTIALLY MATCHED VENEERS

The full cut veneer cathedrals on Ativa tops point toward the center of the table and the veneer is sequentially matched around the entire perimeter of the table. This veneer layup design, where each leaf is used in a sequential manner from the same tree, results in a consistent veneer pattern around the entire table top surface, regardless of the overall size of the table. This layup method is used on the table tops as well as the modesty panels. Table tops are 1-1/4” thick, 30” deep and feature a 1/8” hardwood double bevel edge.

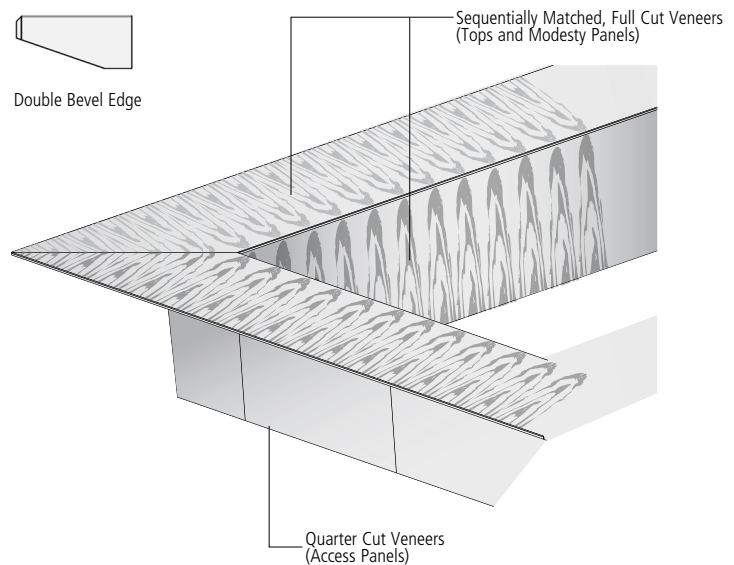
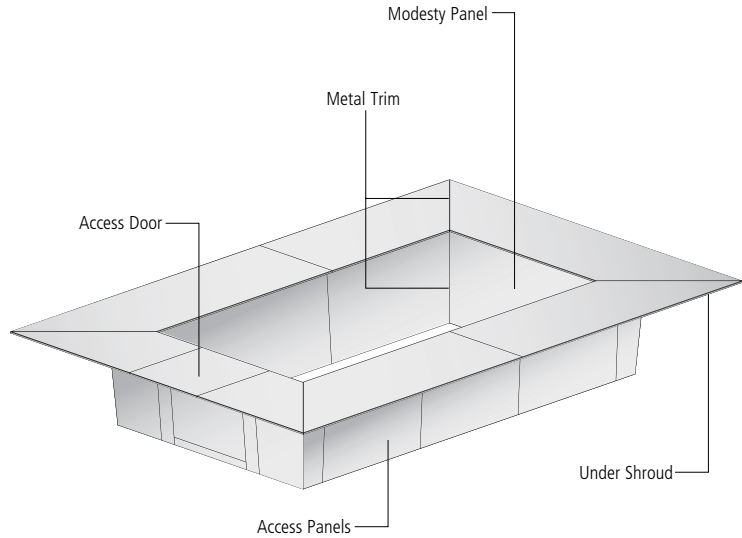



ACCESS DOOR

This innovative feature provides access to the inside of a fully enclosed configuration for cleaning or to retrieve items that may have fallen into this area. It includes a hinged table top section (pneumatic cylinder assisted), a hinged Access Panel and a hinged Modesty Panel (all 24" wide). A 4"-high metal shroud at the floor covers a wire management trough that allows cables to pass through the Access Door opening.

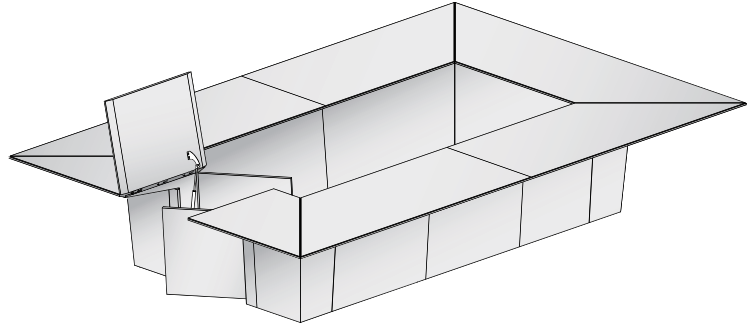

The Access Door is standard on enclosed Ativa tables and is located on one of the four sides of a square table and on one of the short ends of a rectangle table, as illustrated in the drawings below.

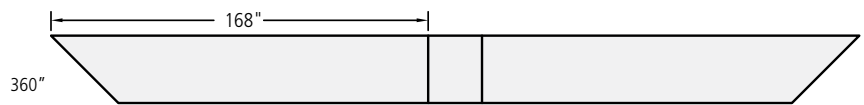
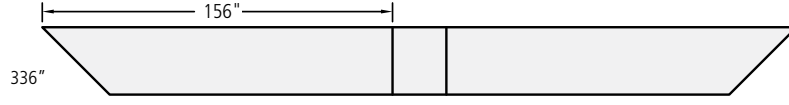
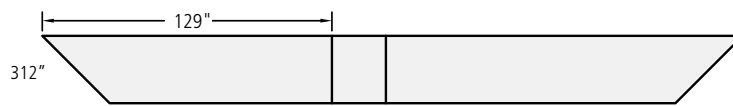
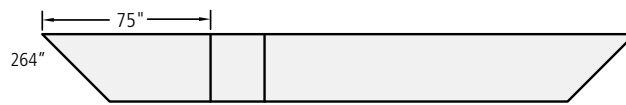
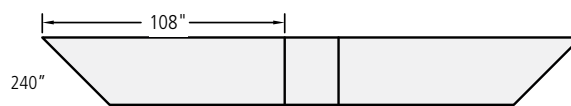
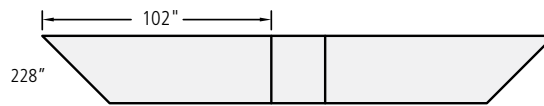
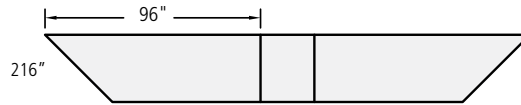
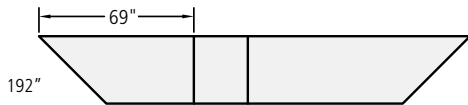
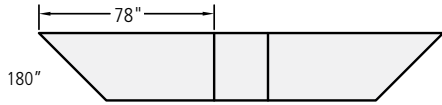
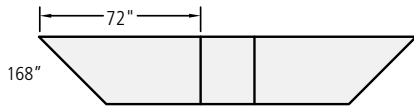
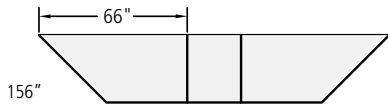
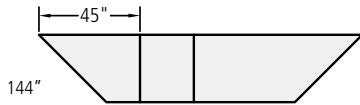
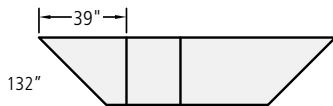
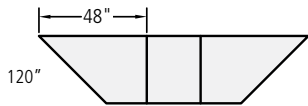
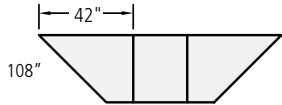
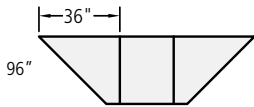

MODESTY WALL

AESTHETICS

The Modesty Wall is the only component of the table that makes contact with the floor. Once attached to the table top, this combination of vertical and horizontal elements provides all the structural integrity the table needs without the need for keels or additional legs.

Modesty Walls are angled away from the user's feet for increased leg room on the user's side and an enhanced aesthetic from across the table.

WIRE MANAGEMENT

The interior of the Modesty Wall is a hollow cavity, much like an architectural wall, offering storage and wire management capabilities.

Power and data cabling is easily accommodated in the spacious area within the Modesty Wall.

Power and data each run in their own area of the Modesty Wall, with power running horizontally in the lower portion of the Wall and data running horizontally in the upper portion of the wall.

UNDER SHROUD

This veneered surface conceals structural elements to offer a clean aesthetic regardless of viewpoint.

SUPPORT STUDS

These metal studs within the Modesty Wall act like studs in an architectural wall, forming a frame and providing rigidity to the structure. Support studs are spaced 30" apart. Corner sections come in numerous sizes to accommodate the wide range of table sizes available as standard on Ativa. Adjustable glides in the bottom of the Modesty Wall studs offer 1-1/4" of adjustability for leveling.

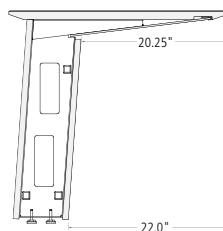
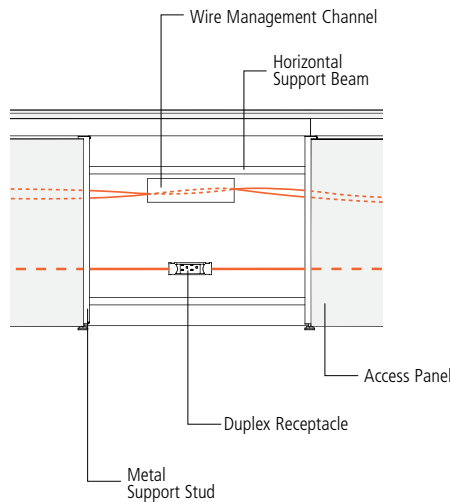
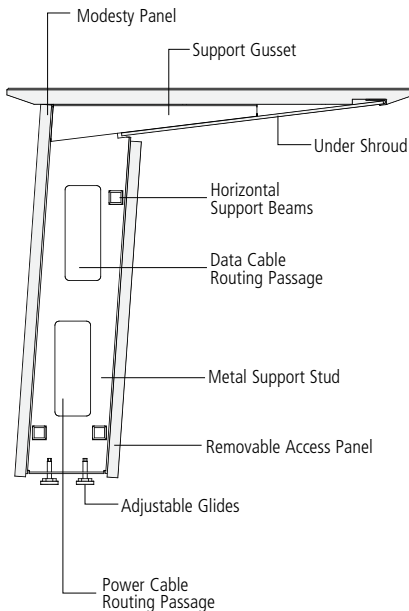

MODESTY PANEL

Located on the interior side of the table, these full height panels are attached to the Support Studs and table top to create a rigid structure. Modesty Panels feature the same sequentially matched veneer layup as the tops for an enhanced aesthetic. Individual lengths up to 120" result in minimal seams. The inside of the Modesty Panel provides a mounting surface for electronic equipment inside the cavity of the Modesty Wall.

REMOVABLE ACCESS PANEL

These removable panels allow clear and unfettered access to the hollow section of the Modesty Wall for easy technology installation and wiring. Access Panels are veneered with quarters, allowing them to be placed in any location around the table. One Access Panel per table includes a cutout in the bottom to allow access into the hollow section of the Modesty Wall for conduit and other cables should the floor monument fall outside the footprint of the Modesty Wall (toward the user's side).

See page 18 for Access Panel dimensions.



RECOMMENDED SEATING CAPACITY

ENCLOSED SQUARE AND RECTANGLE TABLES

Note: Seating capacity is based on 27" per person

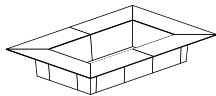

96"-192" LONG		LENGTH								
MODEL #	WIDTH	96" [96]	108" [108]	120" [120]	132" [132]	144" [144]	156" [156]	168" [168]	180" [180]	192" [192]
ATEN-96-[]	96	12	12-14	14	14	14-16	16	16-18	18	18-20
ATEN-108-[]	108		12-16	14-16	14-16	14-18	16-18	16-20	18-20	18-22
ATEN-120-[]	120			16	16	16-18	18	18-20	20	20-22
ATEN-132-[]	132				16	16-18	18	18-20	20	20-22
ATEN-144-[]	144					16-20	18-20	18-22	20-22	20-24
ATEN-156-[]	156						20	20-22	22	22-24
ATEN-168-[]	168							20-24	22-24	22-26
ATEN-180-[]	180								24	24-26
ATEN-192-[]	192									24-28

204"-360" LONG		LENGTH								
MODEL #	WIDTH	204" [204]	216" [216]	228" [228]	240" [240]	264" [264]	288" [288]	312" [312]	336" [336]	360" [360]
ATEN-96-[]	96	18-20	20-22	20-22	22	22-24	24-26	26-28	28-30	30-32
ATEN-108-[]	108	18-22	20-24	20-24	22-24	22-26	24-28	26-30	28-32	30-34
ATEN-120-[]	120	20-22	22-24	22-24	24	24-26	26-28	28-30	30-32	32-34
ATEN-132-[]	132	20-22	22-24	22-24	24	24-26	26-28	28-30	30-32	32-34
ATEN-144-[]	144	20-24	22-26	22-26	24-26	24-28	26-30	28-32	30-34	32-36
ATEN-156-[]	156	22-24	24-26	24-26	26	26-28	28-30	30-32	32-34	34-36
ATEN-168-[]	168	22-26	24-28	24-28	26-28	26-30	28-32	30-34	32-36	34-38
ATEN-180-[]	180	24-26	26-28	26-28	28	28-30	30-32	32-34	34-36	36-38
ATEN-192-[]	192	24-28	26-30	26-30	28-30	28-32	30-34	32-36	34-38	36-40
ATEN-204-[]	204	24-28	26-30	26-30	28-30	28-32	30-34	32-36	34-38	36-40
ATEN-216-[]	216		28-32	28-32	30-32	30-34	32-36	34-38	36-40	38-42
ATEN-228-[]	228			28-32	30-32	30-34	32-36	34-38	36-40	38-42
ATEN-240-[]	240				32	32-34	34-36	36-38	38-40	40-42
ATEN-264-[]	264					32-36	34-38	36-40	38-42	40-44
ATEN-288-[]	288						36-40	38-42	40-44	42-46
ATEN-312-[]	312							40-44	42-46	44-48
ATEN-336-[]	336								44-48	46-50
ATEN-360-[]	360									48-52



RECOMMENDED SEATING CAPACITY

U-SHAPE TABLES

Note: Seating capacity is based on 27" per person

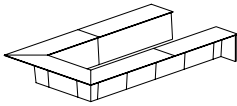

96"-192" LONG

MODEL #	WIDTH	LENGTH								
		96" [96]	108" [108]	120" [120]	132" [132]	144" [144]	156" [156]	168" [168]	180" [180]	192" [192]
ATUS-96-[]	96	9	9-11	11	11	11-13	13	13-15	15	15-17
ATUS-108-[]	108	9-10	9-12	11-12	11-12	11-14	13-14	13-16	15-16	15-18
ATUS-120-[]	120	10	10-12	12	12	12-14	14	14-16	16	16-18
ATUS-132-[]	132	10	10-12	12	12	12-14	14	14-16	16	16-18
ATUS-144-[]	144	10-11	10-13	12-13	12-13	12-15	14-15	14-17	16-17	16-19
ATUS-156-[]	156	11	11-13	13	13	13-15	15	15-17	17	17-19
ATUS-168-[]	168	11-12	11-14	13-14	13-14	13-16	15-16	15-18	17-18	17-20
ATUS-180-[]	180	12	12-14	14	14	14-16	16	16-18	18	18-20
ATUS-192-[]	192	12-13	12-15	14-15	14-15	14-17	16-17	16-19	18-19	18-21
ATUS-204-[]	204	12-13	12-15	14-15	14-15	14-17	16-17	16-19	18-19	18-21
ATUS-216-[]	216	13-14	13-16	15-16	15-16	15-18	17-18	17-20	21-22	19-22
ATUS-228-[]	228	13-14	13-16	15-16	15-16	15-18	17-18	17-20	21-22	19-22
ATUS-240-[]	240	14	14-16	16	16	16-18	18	18-20	20	20-22
ATUS-264-[]	264	14-15	14-17	16-17	16-17	16-19	18-19	18-21	20-21	20-23
ATUS-288-[]	288	15-16	15-18	17-18	17-18	17-20	21-22	19-22	21-22	21-24
ATUS-312-[]	312	16-17	16-19	18-19	18-19	18-21	20-21	20-23	22-23	22-25
ATUS-336-[]	336	17-18	17-20	21-22	21-22	19-22	21-22	21-24	23-24	23-26
ATUS-360-[]	360	18-19	18-21	20-21	20-21	20-23	22-23	22-25	24-25	24-27

204"-360" LONG

MODEL #	WIDTH	LENGTH								
		204" [204]	216" [216]	228" [228]	240" [240]	264" [264]	288" [288]	312" [312]	336" [336]	360" [360]
ATUS-96-[]	96	15-17	17-19	17-19	19	19-21	21-23	23-25	25-27	27-29
ATUS-108-[]	108	15-18	17-20	17-20	21-22	19-22	21-24	23-26	25-28	27-30
ATUS-120-[]	120	16-18	18-20	18-20	20	20-22	22-24	24-26	26-28	28-30
ATUS-132-[]	132	16-18	18-20	18-20	20	20-22	22-24	24-26	26-28	28-30
ATUS-144-[]	144	16-19	18-21	18-21	20-21	20-23	22-25	24-27	26-29	28-31
ATUS-156-[]	156	17-19	19-21	19-21	21	21-23	23-25	25-27	27-29	29-31
ATUS-168-[]	168	17-20	19-22	19-22	21-22	21-24	23-26	25-28	27-30	29-32
ATUS-180-[]	180	18-20	20-22	20-22	22	22-24	24-26	26-28	28-30	30-32
ATUS-192-[]	192	18-21	20-23	20-23	22-23	22-25	24-27	26-29	28-31	30-33
ATUS-204-[]	204	18-21	20-23	20-23	22-23	22-25	24-27	26-29	28-31	30-33
ATUS-216-[]	216	19-22	21-24	21-24	23-24	23-26	25-28	27-30	29-32	31-34
ATUS-228-[]	228	19-22	21-24	21-24	23-24	23-26	25-28	27-30	29-32	31-34
ATUS-240-[]	240	20-22	22-24	22-24	24	24-26	26-28	28-30	30-32	32-34
ATUS-264-[]	264	20-23	22-25	22-25	24-25	24-27	26-29	28-31	30-33	32-35
ATUS-288-[]	288	21-24	23-26	23-26	25-26	25-28	27-30	29-32	31-34	33-36
ATUS-312-[]	312	22-25	24-27	24-27	26-27	26-29	28-31	30-33	32-35	34-37
ATUS-336-[]	336	23-26	25-28	25-28	27-28	27-30	29-32	31-34	33-36	35-38
ATUS-360-[]	360	24-27	26-29	26-29	28-29	28-31	30-33	32-35	34-37	36-39

Note:

The width (A) is always the single side of the table (regardless of table dimensions) while the length (B) refers to the two tops running perpendicular to the width.

Examples:

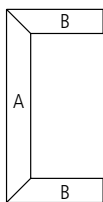
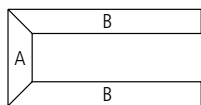

TABLE TOP POWER OPTION: POWER MATRIX SMALL

POWER MATRIX

Power and data connectivity on Ativa tables is provided via Power Matrix units located on the table top in pre-determined locations and quantities based on the size of the table (see charts on pages 16-17 and illustrations on page 15).

Power Matrix provides easy table top accessibility and voice/data connectivity in a small footprint. Doors are available in metal, glass and grain-matched wood. The interior is anodized aluminum. When specified on tables with laminate tops, each Power Matrix includes a 3/8"-wide metal bezel. The wood door version is not available on tables with laminate tops.

Power Matrix units are plugged into a two-circuit electrical system located in the base of the Ativa modesty wall. The charts on pages 16-17 identify the quantity of Power Matrix units based on table size, as well as the number of circuits required to adequately power the table.

Plugged into two-circuit electrical system.

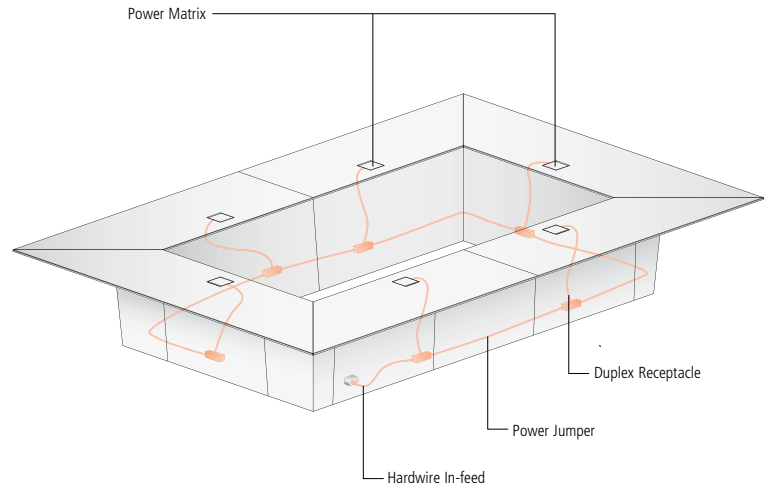

Two-Circuit Modular Electrical System

- 4-wire, 20-amp, 2-circuit modular electrical system
- Only present on tables specified with the Single In-Feed option
- Hardwire or corded (20-amp) in-feed options. A licensed electrician is required to complete hardwire connections to building's power source.
- Neutral (white) wires are 10 gauge, hot and ground wires are 12 gauge
- All electrical components satisfy National Electrical Code (NEC) requirements and are UL listed

Electrical Diagram — Hardwire Power Infeed Only

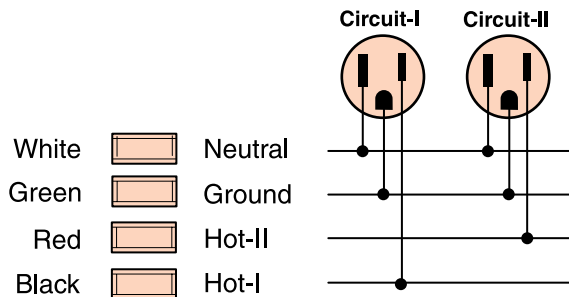

VOICE/DATA PLANNING

Consult a local electrical contractor for proper code compliance information. Nucraft recommends consulting an audio/visual (AV) integrator for specific assistance with voice/data planning.

Voice/Data Product Manufacturers

Manufacturer	Phone Number	Web Site
AMP	1-800-522-6752	www.tycoelectronics.com
Avaya	1-866-462-8292	www.avaya.com
Leviton	1-800-722-2082	www.leviton.com
Panduit	1-800-777-3300	www.panduit.com
Siemon	1-860-945-4200	www.siemon.com



TABLE TOP POWER OPTION: POWER MATRIX SMALL

Power Matrix is filled with a broad array of high performance features and refined aesthetic elements.

POWER

Power Matrix features two simplex receptacles for power connectivity. An optional USB-A+C charger can also be specified in place of one of the simplex receptacles when desired. Corded or hardwired in-feed options add flexibility.

DATA/AV FACEPLATES

Power Matrix accommodates Modular AV Inserts/Plates for unparalleled flexibility in data and AV connectivity.

DESIGN

Power Matrix units feature a clear anodized aluminum body and a bezel-free flush mount design on wood tables for an elegant appearance. Laminate table tops include a bezel, available in powder coat, polished chrome or clear anodized finish options.

PERFORMANCE

Friction hinges ensure smooth travel through the door's range of motion and can hold the door in any position. Hidden door stops maintain the minimalist aesthetic. Cable storage is both concealed and ample.

DOORS

Power Matrix is offered in multiple door material options, including metal, glass and grain-matched wood cut from the same table top.

Power Matrix is equipped with the following components:

- Single door design
- 5.375" x 6" cutout
- Two simplex outlets
- Three AV faceplates. Standard configuration includes two blank faceplates and one faceplate with two RJ-45 (data) connectors.
- (1) 12' plug-in infeed cord

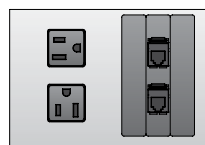
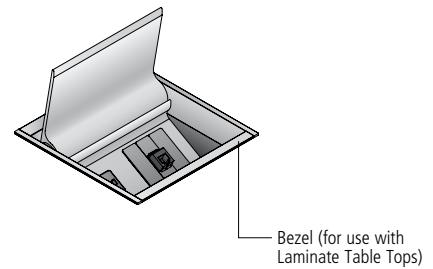
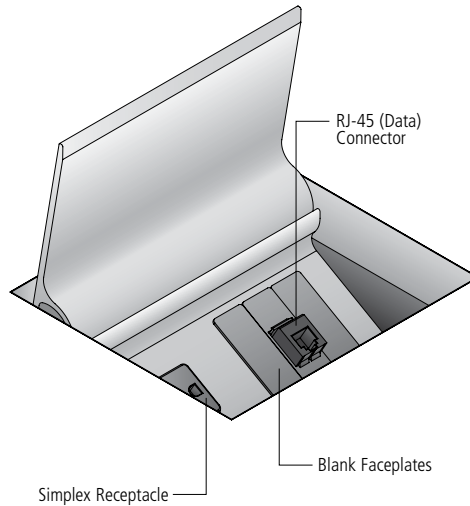

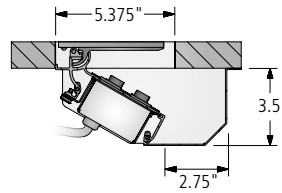

TABLE TOP POWER OPTION: POWER MATRIX SMALL

DIMENSIONS

Each Power Matrix unit includes a low-rofile pan beneath the work surface to conceal the unit and provide ample storage capacity for excess cables.

End Elevation View



Plan View

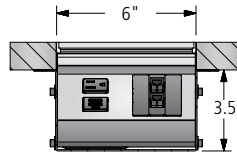

FIELD-WIRED

Some local electrical codes may require field-wiring during installation. In such instances, a Field-Wired option may be specified. In this configuration, each Power Matrix unit will be supplied with a 6' flexible metal conduit with hot, ground and neutral wires.





RETRACTORS FOR POWER MATRIX

Cable retractors mount directly to the underside of conference room tables using the included mounting bracket. Loaded with 12' of cable that extends out 5' from the retractor. Retractors have a female input from the building infrastructure and a male connector on the output side.

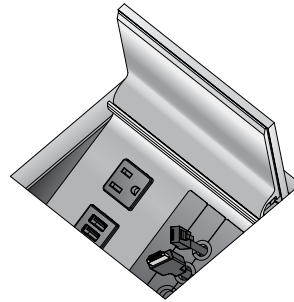

Retractor Wire Management

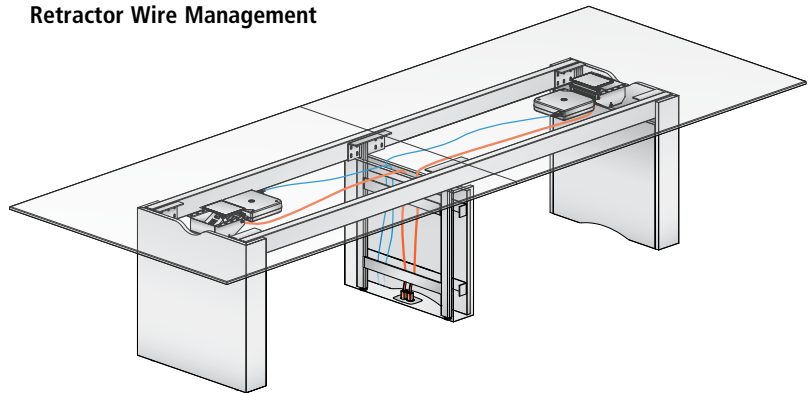

CAT6 Retractor

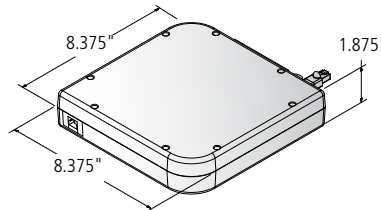

HDMI Retractor

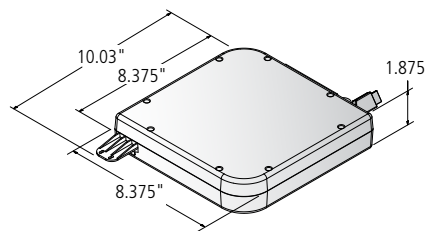

Data USB Retractor

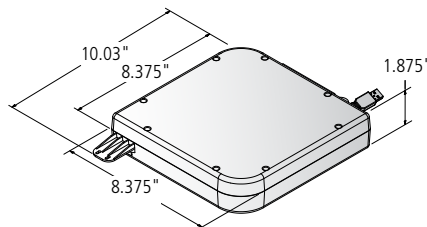



FREESTANDING POWER OPTION: TECH ZONE

TECH ZONE

Simple, easy to use and portable, this freestanding table top power option allows you to easily charge all of your devices.

Available in two configurations with a variety of power and data connectivity options. Includes a 72"-long plug-in infeed cord.

ZONE-USB-C

Includes two simplex receptacles, one data port and one charging USB-A+C charging port

ZONE-DATA

Includes two simplex receptacles and two open data ports

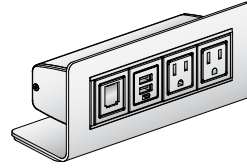

Tech Zone - Side View

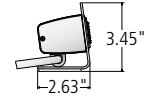

ZONE-USB-C

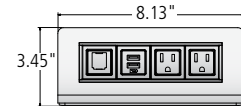

ZONE-DATA

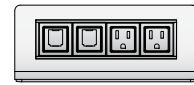



POWER MATRIX LOCATION OPTIONS

The following illustrations show the Power Matrix locations based on the length of each table side.

■ Power Matrix

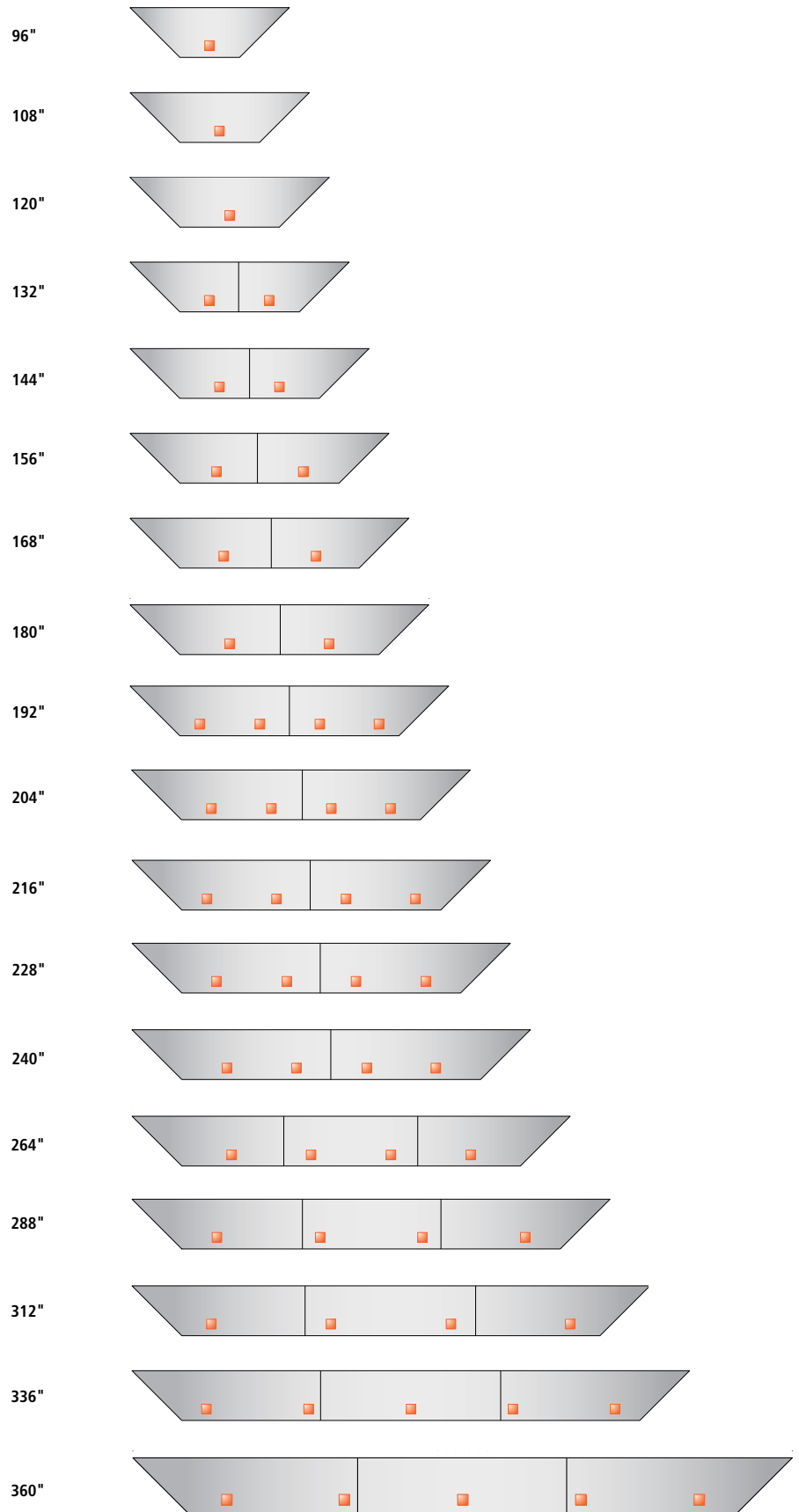



POWER AND VOICE/DATA CAPABILITIES

The adjacent chart details the quantity of Power Matrix units provided with each table size, the resulting quantity of power and data connections and the number of circuits required to properly power the table.

Each circuit in the Power Matrix electrical system is rated for a Maximum of 20 amps of intermittent use or 16 amps of continuous load (continuous load defined as three hours or more of constant use). Nucraft recommends planning for continuous load. The National Electrical Code (NEC) restricts a 20 amp circuit to a maximum of 24 receptacles. In Canada, the national system is rated for 15 amps, and receptacles are limited to 20. NOTE: The above standards are maximum amounts only. Always check your local codes for restrictions.

CODE	POWER MATRIX UNITS	SIMPLEX RECEPTACLES PROVIDED	DATA RJ-45 PROVIDED	BLANK MODULAR AV INSERTS/PLATES PROVIDED	FLOOR CORE CIRCUITS REQUIRED	FIELD-WIRED DEDUCTION	USB-A+C CHARGING*	POLISHED CHROME DOOR	POLISHED CHROME BEZEL
A	3	6	6	6	2	1,110	384	735	1,047
B	4	8	8	8	2	1,482	512	980	1,396
C	5	10	10	10	2	1,851	640	1,225	1,745
D	6	12	12	12	2	2,216	768	1,470	2,094
E	7	14	14	14	2	2,591	896	1,715	2,443
F	8	16	16	16	2	2,959	1,024	1,960	2,792
G	9	18	18	18	2	3,327	1,152	2,205	3,141
H	10	20	20	20	2	3,697	1,280	2,450	3,490
I	11	22	22	22	2	4,065	1,408	2,695	3,839
J	12	24	24	24	2	4,435	1,536	2,940	4,188
K	13	26	26	26	2	4,900	1,664	3,185	4,537
L	14	28	28	28	2	5,271	1,792	3,430	4,886
M	15	30	30	30	2	5,639	1,920	3,675	5,235
N	16	32	32	32	2	6,012	2,048	3,920	5,584
O	18	36	36	36	2	6,747	2,304	4,410	6,282
P	20	40	40	40	2	7,485	2,560	4,900	6,980

*When specified, Charging USB-A+C option will replace (1) Simplex Receptacle

ENCLOSED SQUARE AND RECTANGLE TABLES

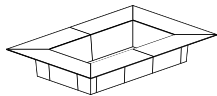

96"-192" LONG

MODEL #	WIDTH	LENGTH								
		96" [96]	108" [108]	120" [120]	132" [132]	144" [144]	156" [156]	168" [168]	180" [180]	192" [192]
ATEN-96-[]	96	B	B	B	D	D	D	D	D	H
ATEN-108-[]	108		B	B	D	D	D	D	D	H
ATEN-120-[]	120			B	D	D	D	D	D	H
ATEN-132-[]	132				F	F	F	F	F	J
ATEN-144-[]	144					F	F	F	F	J
ATEN-156-[]	156						F	F	F	J
ATEN-168-[]	168							F	F	J
ATEN-180-[]	180								F	J
ATEN-192-[]	192									N

204"-360" LONG

MODEL #	WIDTH	LENGTH								
		204" [204]	216" [216]	228" [228]	240" [240]	264" [264]	288" [288]	312" [312]	336" [336]	360" [360]
ATEN-96-[]	96	H	H	H	H	H	H	H	J	J
ATEN-108-[]	108	H	H	H	H	H	H	H	J	J
ATEN-120-[]	120	H	H	H	H	H	H	H	J	J
ATEN-132-[]	132	J	J	J	J	J	J	J	L	L
ATEN-144-[]	144	J	J	J	J	J	J	J	L	L
ATEN-156-[]	156	J	J	J	J	J	J	J	L	L
ATEN-168-[]	168	J	J	J	J	J	J	J	L	L
ATEN-180-[]	180	J	J	J	J	J	J	J	L	L
ATEN-192-[]	192	N	N	N	N	N	N	N	O	O
ATEN-204-[]	204	N	N	N	N	N	N	N	O	O
ATEN-216-[]	216		N	N	N	N	N	N	O	O
ATEN-228-[]	228			N	N	N	N	N	O	O
ATEN-240-[]	240				N	N	N	N	O	O
ATEN-264-[]	264					N	N	N	O	O
ATEN-288-[]	288						N	N	O	O
ATEN-312-[]	312							N	O	O
ATEN-336-[]	336								P	P
ATEN-360-[]	360									P



POWER AND VOICE/DATA CAPABILITIES

U-SHAPE TABLES

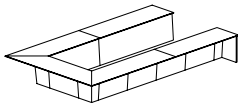

96"-192" LONG

MODEL #	WIDTH	LENGTH								
		96" [96]	108" [108]	120" [120]	132" [132]	144" [144]	156" [156]	168" [168]	180" [180]	192" [192]
ATUS-96-[]	96	A	A	A	C	C	C	C	C	G
ATUS-108-[]	108	A	A	A	C	C	C	C	C	G
ATUS-120-[]	120	A	A	A	C	C	C	C	C	G
ATUS-132-[]	132	B	B	B	D	D	D	D	D	H
ATUS-144-[]	144	B	B	B	D	D	D	D	D	H
ATUS-156-[]	156	B	B	B	D	D	D	D	D	H
ATUS-168-[]	168	B	B	B	D	D	D	D	D	H
ATUS-180-[]	180	B	B	B	D	D	D	D	D	H
ATUS-192-[]	192	D	D	D	F	F	F	F	F	J
ATUS-204-[]	204	D	D	D	F	F	F	F	F	J
ATUS-216-[]	216	D	D	D	F	F	F	F	F	J
ATUS-228-[]	228	D	D	D	F	F	F	F	F	J
ATUS-240-[]	240	D	D	D	F	F	F	F	F	J
ATUS-264-[]	264	D	D	D	F	F	F	F	F	J
ATUS-288-[]	288	D	D	D	F	F	F	F	F	J
ATUS-312-[]	312	D	D	D	F	F	F	F	F	J
ATUS-336-[]	336	E	E	E	G	G	G	G	G	K
ATUS-360-[]	360	E	E	E	G	G	G	G	G	K

204"-360" LONG

MODEL #	WIDTH	LENGTH								
		204" [204]	216" [216]	228" [228]	240" [240]	264" [264]	288" [288]	312" [312]	336" [336]	360" [360]
ATUS-96-[]	96	G	G	G	G	G	G	G	I	I
ATUS-108-[]	108	G	G	G	G	G	G	G	I	I
ATUS-120-[]	120	G	G	G	G	G	G	G	I	I
ATUS-132-[]	132	H	H	H	H	H	H	H	J	J
ATUS-144-[]	144	H	H	H	H	H	H	H	J	J
ATUS-156-[]	156	H	H	H	H	H	H	H	J	J
ATUS-168-[]	168	H	H	H	H	H	H	H	J	J
ATUS-180-[]	180	H	H	H	H	H	H	H	J	J
ATUS-192-[]	192	J	J	J	J	J	J	J	L	L
ATUS-204-[]	204	J	J	J	J	J	J	J	L	L
ATUS-216-[]	216	J	J	J	J	J	J	J	L	L
ATUS-228-[]	228	J	J	J	J	J	J	J	L	L
ATUS-240-[]	240	J	J	J	J	J	J	J	L	L
ATUS-264-[]	264	J	J	J	J	J	J	J	L	L
ATUS-288-[]	288	J	J	J	J	J	J	J	L	L
ATUS-312-[]	312	J	J	J	J	J	J	J	L	L
ATUS-336-[]	336	K	K	K	K	K	K	K	M	M
ATUS-360-[]	360	K	K	K	K	K	K	K	M	M

DIMENSIONS

Base Dimensions at the Floor (Plan View)

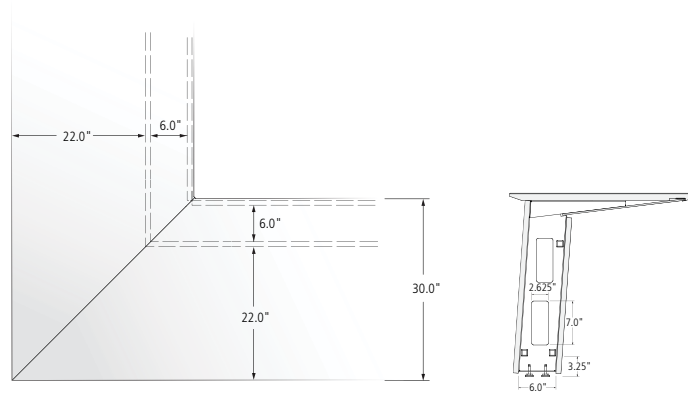

Access Panel (Shown with cutout on bottom)

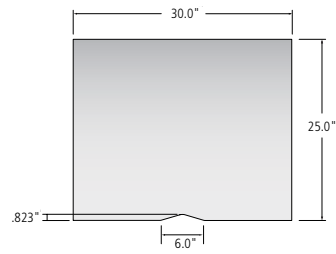



VENEER TOP WITH HARDWOOD EDGE

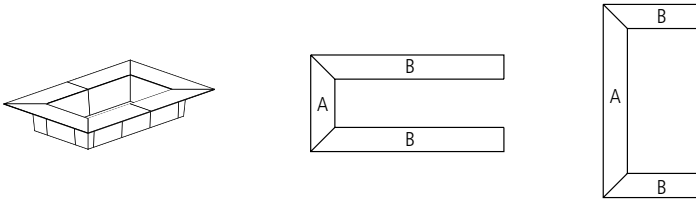

96"-192" LONG

MODEL #	WIDTH [A]	LENGTH [B]								
		96" [96]	108" [108]	120" [120]	132" [132]	144" [144]	156" [156]	168" [168]	180" [180]	192" [192]
ATEN-96-[]	96	35,405	39,050	42,694	46,336	49,981	53,626	57,269	60,913	64,556
ATEN-108-[]	108		42,694	46,336	49,981	53,626	57,269	60,913	64,556	68,200
ATEN-120-[]	120			49,981	53,626	57,269	60,913	64,556	68,200	71,846
ATEN-132-[]	132				57,269	60,913	64,556	68,200	71,846	75,491
ATEN-144-[]	144					64,556	68,200	71,846	75,491	79,131
ATEN-156-[]	156						71,846	75,491	79,131	82,776
ATEN-168-[]	168							79,131	82,776	86,419
ATEN-180-[]	180								86,419	90,064
ATEN-192-[]	192									93,707

204"-360" LONG

MODEL #	WIDTH [A]	LENGTH [B]								
		204" [204]	216" [216]	228" [228]	240" [240]	264" [264]	288" [288]	312" [312]	336" [336]	360" [360]
ATEN-96-[]	96	68,200	71,846	75,491	79,131	86,419	93,707	100,995	108,283	115,570
ATEN-108-[]	108	71,846	75,491	79,131	82,776	90,064	97,353	104,641	111,927	119,215
ATEN-120-[]	120	75,491	79,131	82,776	86,419	93,707	100,995	108,283	115,570	122,856
ATEN-132-[]	132	79,131	82,776	86,419	90,064	97,353	104,641	111,927	119,215	126,501
ATEN-144-[]	144	82,776	86,419	90,064	93,707	100,995	108,283	115,570	122,856	130,145
ATEN-156-[]	156	86,419	90,064	93,707	97,353	104,641	111,927	119,215	126,501	133,789
ATEN-168-[]	168	90,064	93,707	97,353	100,995	108,283	115,570	122,856	130,145	137,432
ATEN-180-[]	180	93,707	97,353	100,995	104,641	111,927	119,215	126,501	133,789	141,078
ATEN-192-[]	192	97,353	100,995	104,641	108,283	115,570	122,856	130,145	137,432	144,719
ATEN-204-[]	204	100,995	104,641	108,283	111,927	119,215	126,501	133,789	141,078	148,365
ATEN-216-[]	216		108,283	111,927	115,570	122,856	130,145	137,432	144,719	152,009
ATEN-228-[]	228			115,570	119,215	126,501	133,789	141,078	148,365	155,652
ATEN-240-[]	240				122,856	130,145	137,432	144,719	152,009	159,297
ATEN-264-[]	264					137,432	144,719	152,009	159,297	166,582
ATEN-288-[]	288						152,009	159,297	166,582	173,870
ATEN-312-[]	312							166,582	173,870	181,161
ATEN-336-[]	336								181,161	188,445
ATEN-360-[]	360									195,736

EDGE PROFILE



Double Bevel Edge

GENERAL INFORMATION

- Tops are 1-1/4" thick
- Overall table height 29-1/2"
- Access Door is standard on enclosed Ativa tables and is located on one of the four sides of square tables and on one of the short sides of Rectangle tables
- Corner metal accent pieces will default to clear anodized aluminum if metal finish is not specified

REQUIRED INFORMATION (ORDER CANNOT BE ENTERED WITHOUT THIS INFORMATION)

See appendix page vi for surface material options.

- Choose Veneer Finish
- Choose Metal Finish



INSET LAMINATE TOP WITH HARDWOOD EDGE

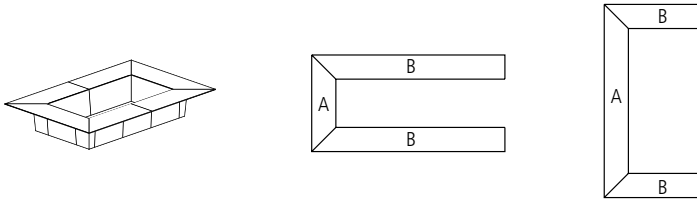

96"-192" LONG

MODEL #	WIDTH [A]	LENGTH [B]								
		96" [96]	108" [108]	120" [120]	132" [132]	144" [144]	156" [156]	168" [168]	180" [180]	192" [192]
ATEN-96-[]-P	96	33,916	37,395	40,874	44,354	47,833	51,316	54,792	58,272	61,754
ATEN-108-[]-P	108		40,874	44,354	47,833	51,316	54,792	58,272	61,754	65,231
ATEN-120-[]-P	120			47,833	51,316	54,792	58,272	61,754	65,231	68,715
ATEN-132-[]-P	132				54,792	58,272	61,754	65,231	68,715	72,193
ATEN-144-[]-P	144					61,754	65,231	68,715	72,193	75,675
ATEN-156-[]-P	156						68,715	72,193	75,675	79,154
ATEN-168-[]-P	168							75,675	79,154	82,631
ATEN-180-[]-P	180								82,631	86,114
ATEN-192-[]-P	192									89,592

204"-360" LONG

MODEL #	WIDTH [A]	LENGTH [B]								
		204" [204]	216" [216]	228" [228]	240" [240]	264" [264]	288" [288]	312" [312]	336" [336]	360" [360]
ATEN-96-[]-P	96	65,231	68,715	72,193	75,675	82,631	89,592	96,551	103,512	110,471
ATEN-108-[]-P	108	68,715	72,193	75,675	79,154	86,114	93,073	100,031	106,992	113,951
ATEN-120-[]-P	120	72,193	75,675	79,154	82,631	89,592	96,551	103,512	110,471	117,433
ATEN-132-[]-P	132	75,675	79,154	82,631	86,114	93,073	100,031	106,992	113,951	120,911
ATEN-144-[]-P	144	79,154	82,631	86,114	89,592	96,551	103,512	110,471	117,433	124,391
ATEN-156-[]-P	156	82,631	86,114	89,592	93,073	100,031	106,992	113,951	120,911	127,870
ATEN-168-[]-P	168	86,114	89,592	93,073	96,551	103,512	110,471	117,433	124,391	131,349
ATEN-180-[]-P	180	89,592	93,073	96,551	100,031	106,992	113,951	120,911	127,870	134,831
ATEN-192-[]-P	192	93,073	96,551	100,031	103,512	110,471	117,433	124,391	131,349	138,309
ATEN-204-[]-P	204	96,551	100,031	103,512	106,992	113,951	120,911	127,870	134,831	141,790
ATEN-216-[]-P	216		103,512	106,992	110,471	117,433	124,391	131,349	138,309	145,269
ATEN-228-[]-P	228			110,471	113,951	120,911	127,870	134,831	141,790	148,749
ATEN-240-[]-P	240				117,433	124,391	131,349	138,309	145,269	152,229
ATEN-264-[]-P	264					131,349	138,309	145,269	152,229	159,189
ATEN-288-[]-P	288						145,269	152,229	159,189	166,148
ATEN-312-[]-P	312							159,189	166,148	173,108
ATEN-336-[]-P	336								173,108	180,066
ATEN-360-[]-P	360									187,027

EDGE PROFILE



Double Bevel Edge

GENERAL INFORMATION

- Tops are 1-1/4" thick
- Overall table height 29-1/2"
- Access Door is standard on enclosed Ativa tables and is located on one of the four sides of square tables and on one of the short sides of Rectangle tables
- Corner metal accent pieces will default to clear anodized aluminum if metal finish is not specified

REQUIRED INFORMATION (ORDER CANNOT BE ENTERED WITHOUT THIS INFORMATION)

See appendix page vi for surface material options.

- Choose Veneer Finish
- Choose Laminate (Woodgrain Laminate not available)
- Choose Metal Finish



VENEER TOP WITH HARDWOOD EDGE / GLASS OR METAL DOOR POWER MATRIX

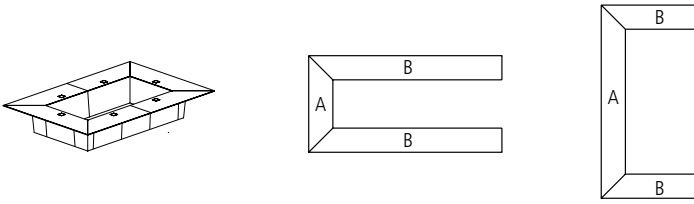

96"-192" LONG

LENGTH [B]

MODEL #	WIDTH [A]	96" [96]	108" [108]	120" [120]	132" [132]	144" [144]	156" [156]	168" [168]	180" [180]	192" [192]
ATEN-96-[]	96	43,035	46,674	50,315	57,677	61,318	64,960	68,599	72,241	83,324
ATEN-108-[]	108		50,315	53,957	61,318	64,960	68,599	72,241	72,241	86,963
ATEN-120-[]	120			57,596	64,960	68,599	72,241	75,882	79,522	90,605
ATEN-132-[]	132				72,321	75,960	79,600	83,242	86,884	97,967
ATEN-144-[]	144					79,600	83,242	86,884	90,524	101,610
ATEN-156-[]	156						86,884	90,524	94,165	105,248
ATEN-168-[]	168							94,165	97,804	108,888
ATEN-180-[]	180								101,445	112,527
ATEN-192-[]	192									123,707

204"-360" LONG

LENGTH [B]

MODEL #	WIDTH [A]	204" [204]	216" [216]	228" [228]	240" [240]	264" [264]	288" [288]	312" [312]	336" [336]	360" [360]
ATEN-96-[]	96	86,963	90,605	94,245	97,889	105,166	112,449	119,730	130,735	138,012
ATEN-108-[]	108	90,605	94,245	97,889	101,526	108,807	116,087	123,371	134,372	141,656
ATEN-120-[]	120	94,245	97,889	101,526	105,166	112,449	119,730	127,010	138,012	145,295
ATEN-132-[]	132	101,610	105,248	108,888	112,527	119,808	127,090	134,372	145,473	152,751
ATEN-144-[]	144	105,248	108,888	112,527	115,873	123,450	130,735	137,866	149,116	156,395
ATEN-156-[]	156	108,888	112,527	115,873	119,808	127,090	134,372	141,656	152,751	160,038
ATEN-168-[]	168	112,527	116,171	119,808	123,156	130,735	138,012	145,295	156,395	163,677
ATEN-180-[]	180	116,171	119,808	123,450	127,090	134,372	141,656	148,934	160,038	167,316
ATEN-192-[]	192	127,350	130,988	134,629	138,271	145,550	152,835	160,115	171,119	178,401
ATEN-204-[]	204	130,988	134,629	138,271	141,911	149,191	156,474	163,753	173,124	182,040
ATEN-216-[]	216		138,271	141,911	145,550	152,835	160,115	167,398	178,401	185,682
ATEN-228-[]	228			145,550	149,191	156,474	163,753	171,035	182,040	189,322
ATEN-240-[]	240				152,835	160,115	167,398	174,677	185,682	192,959
ATEN-264-[]	264					167,398	174,677	181,960	192,959	200,246
ATEN-288-[]	288						181,960	189,238	200,246	207,523
ATEN-312-[]	312							196,524	207,523	214,805
ATEN-336-[]	336								218,527	225,804
ATEN-360-[]	360									233,090



VENEER TOP WITH HARDWOOD EDGE / GLASS OR METAL DOOR POWER MATRIX

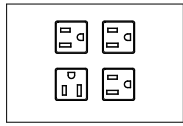

-FOUR

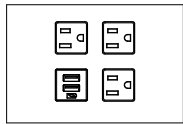

-THREE-C

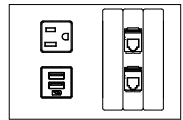

-USB-C

OPTIONS	CODE	NOTES
4 Simplex Receptacles	Add -FOUR	Replace Modular AV Inserts/Plates with 2 simplex receptacles
3 Simplex Receptacles/Charging USB-A+C	Add -THREE-C	Replace Modular AV Inserts/Plates with 1 simplex receptacle and 1 charging USB-A+C
USB-A+C Charging	Add -USB-C	USB-A+C charger, replaces one simplex receptacle per Power Matrix Unit. Refer to pages 16-17 to determine how much to add based on table size.
Polished Chrome Door	Add -PD	Only available with metal door option. Refer to pages 16-17 to determine how much to add based on table size.
Field-Wired	Add -FW	Refer to pages 16-17 to determine how much to deduct based on table size. The city of Chicago may require hardwiring of components and may not allow the use of standard modular power systems. A junction box will be provided when ordering the -FW option.

EDGE PROFILE



Double Bevel Edge

GENERAL INFORMATION

- Tops are 1-1/4" thick
- Overall table height 29-1/2"
- Access Door is standard on enclosed Ativa tables and is located on one of the four sides of square tables and on one of the short sides of rectangle tables
- Power Matrix glass doors are back-painted 1/4" optically clear, low-iron glass
- All Power Matrix interior components are clear anodized aluminum
- When specified with metal Power Matrix doors, the color of the metal trim on the table top and modesty panels will match the Power Matrix door finish
- When specified with glass Power Matrix doors, the metal trim will be clear anodized aluminum
- Quantity of Power Matrix units is dependent on table dimensions. See pages 16-17 for more information.

REQUIRED INFORMATION (ORDER CANNOT BE ENTERED WITHOUT THIS INFORMATION)

See appendix page vi for surface material options.

- Choose Veneer Finish
- Choose Metal Finish
- Choose Power Matrix Door Material: Metal (-M) or Glass (-G)
- Choose Power Matrix Metal Door Finish, if -M is specified
- Choose Power Matrix Glass Door Finish, if -G is specified

RETRACTORS	MODEL #	DESCRIPTION	PRICE
	CR-CAT6	CAT6 Retractor	996
	CR-HDMI	HDMI Retractor	996
	CR-DISPLAY	Display Port Retractor	996
	CR-USB	Data USB Retractor	996

CR-HDMI

GENERAL INFORMATION

- Mounting bracket and attaching hardware included with each retractor
- Can only be used with Power Matrix Small or Medium units
- One Cable Pass Through Set (one top, one bottom) Modular AV Insert/Plate included. Double style Modular AV Inserts/Plates.
- Limited to two retractor units inside of the modesty panels



INSET LAMINATE TOP WITH HARDWOOD EDGE / GLASS OR METAL DOOR POWER MATRIX

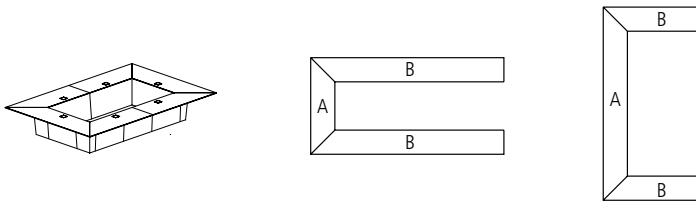

96"-192" LONG

MODEL #	WIDTH [A]	LENGTH [B]								
		96" [96]	108" [108]	120" [120]	132" [132]	144" [144]	156" [156]	168" [168]	180" [180]	192" [192]
ATEN-96-[]-P	96	41,543	45,017	48,495	55,696	59,173	62,646	66,125	69,601	80,521
ATEN-108-[]-P	108		48,495	51,973	59,173	62,646	66,125	69,601	73,078	83,997
ATEN-120-[]-P	120			55,451	62,646	66,125	69,601	73,078	76,554	87,475
ATEN-132-[]-P	132				69,848	73,325	76,799	80,274	83,754	94,674
ATEN-144-[]-P	144					76,799	80,274	83,754	87,230	98,153
ATEN-156-[]-P	156						83,754	87,230	90,707	101,627
ATEN-168-[]-P	168							94,184	97,660	105,104
ATEN-180-[]-P	180								97,660	108,580
ATEN-192-[]-P	192									119,595

204"-360" LONG

MODEL #	WIDTH [A]	LENGTH [B]								
		204" [204]	216" [216]	228" [228]	240" [240]	264" [264]	288" [288]	312" [312]	336" [336]	360" [360]
ATEN-96-[]-P	96	83,997	87,475	90,952	94,429	82,631	108,335	115,291	125,964	132,919
ATEN-108-[]-P	108	87,475	90,952	94,429	97,907	105,264	111,813	118,766	129,440	136,396
ATEN-120-[]-P	120	90,952	94,429	97,907	101,381	108,335	115,291	122,244	132,919	139,875
ATEN-132-[]-P	132	98,153	101,627	105,104	108,580	115,534	122,487	129,440	140,215	147,171
ATEN-144-[]-P	144	101,627	105,104	108,580	112,057	119,011	125,964	132,919	143,693	150,649
ATEN-156-[]-P	156	105,104	108,580	112,057	115,534	122,487	129,440	136,396	147,171	154,121
ATEN-168-[]-P	168	108,580	112,057	115,534	119,011	125,964	132,919	139,875	150,649	157,597
ATEN-180-[]-P	180	112,057	115,534	119,011	122,487	129,440	136,396	143,350	154,857	161,077
ATEN-192-[]-P	192	123,073	126,549	130,027	133,505	140,456	147,409	154,367	165,039	171,996
ATEN-204-[]-P	204	126,549	130,027	133,505	136,977	143,932	150,886	157,915	168,514	175,470
ATEN-216-[]-P	216		133,505	136,977	140,456	147,409	154,367	161,316	171,996	178,949
ATEN-228-[]-P	228			140,456	143,932	150,886	157,842	164,795	175,470	182,424
ATEN-240-[]-P	240				147,409	154,367	161,316	168,273	178,949	185,901
ATEN-264-[]-P	264					161,316	168,273	175,225	185,901	192,852
ATEN-288-[]-P	288						175,225	182,179	192,852	199,808
ATEN-312-[]-P	312							189,136	199,808	206,759
ATEN-336-[]-P	336								210,480	217,435
ATEN-360-[]-P	360									224,388



INSET LAMINATE TOP WITH HARDWOOD EDGE / GLASS OR METAL DOOR POWER MATRIX

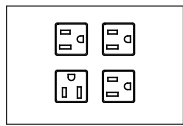

-FOUR

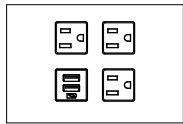

-THREE-C

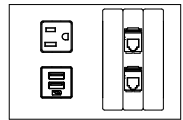

-USB-C

OPTIONS	CODE	NOTES
4 Simplex Receptacles	Add -FOUR	Replace Modular AV Inserts/Plates with 2 simplex receptacles
3 Simplex Receptacles/Charging USB-A+C	Add -THREE-C	Replace Modular AV Inserts/Plates with 1 simplex receptacle and 1 charging USB-A+C
USB-A+C Charging	Add -USB-C	USB-A+C charger, replaces one simplex receptacle per Power Matrix Unit. Refer to pages 16-17 to determine how much to add based on table size.
Polished Chrome Door	Add -PD	Only available with metal door option. Refer to pages 16-17 to determine how much to add based on table size.
Polished Chrome Bezel	Add -PB	Only available on laminate top tables. Refer to pages 16-17 to determine how much to add based on table size.
Field-Wired	Add -FW	Refer to pages 16-17 to determine how much to deduct based on table size. The city of Chicago may require hardwiring of components and may not allow the use of standard modular power systems. A junction box will be provided when ordering the -FW option.

EDGE PROFILE



Double Bevel Edge

GENERAL INFORMATION

- Tops are 1-1/4" thick
- Overall table height 29-1/2"
- Access Door is standard on enclosed Ativa tables and is located on one of the four sides of square tables and on one of the short sides of rectangle tables
- Power Matrix glass doors are back-painted 1/4" optically clear, low-iron glass
- All Power Matrix interior components are clear anodized aluminum
- When specified with metal Power Matrix doors, the color of the metal trim on the table top and modesty panels will match the Power Matrix door finish
- When specified with glass Power Matrix doors, the metal trim will be clear anodized aluminum
- Each Power Matrix unit includes a 3/8"-wide metal bezel
- Quantity of Power Matrix units is dependent on table dimensions. See pages 16-17 for more information.

REQUIRED INFORMATION (ORDER CANNOT BE ENTERED WITHOUT THIS INFORMATION)

See appendix page vi for surface material options.

- Choose Veneer Finish
- Choose Laminate (Wood-grain laminate not available)
- Choose Metal Finish
- Choose Power Matrix Door Material: Metal (-M) or Glass (-G)
- Choose Power Matrix Metal Door Finish, if -M is specified
- Choose Power Matrix Glass Door Finish, if -G is specified

RETRACTORS

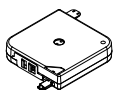

CR-HDMI

MODEL #	DESCRIPTION	PRICE
CR-CAT6	CAT6 Retractor	996
CR-HDMI	HDMI Retractor	996
CR-DISPLAY	Display Port Retractor	996
CR-USB	Data USB Retractor	996

GENERAL INFORMATION

- Mounting bracket and attaching hardware included with each retractor
- Can only be used with Power Matrix Small or Medium units
- One Cable Pass Through Set (one top, one bottom) Modular AV Insert/Plate included. Double style Modular AV Inserts/Plates.
- Limited to two retractor units inside of the modesty panels



VENEER TOP WITH HARDWOOD EDGE / WOOD DOOR POWER MATRIX

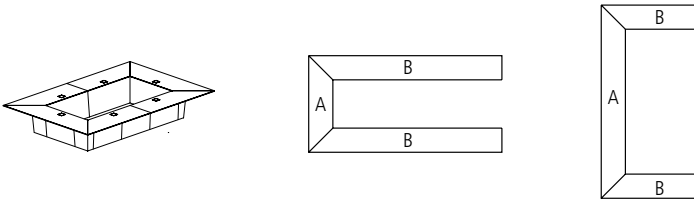

96"-192" LONG

LENGTH [B]

MODEL #	WIDTH [A]	96" [96]	108" [108]	120" [120]	132" [132]	144" [144]	156" [156]	168" [168]	180" [180]	192" [192]
ATEN-96-[]	96	44,833	48,476	52,116	60,377	64,019	67,660	71,302	74,939	87,679
ATEN-108-[]	108		52,116	55,754	64,019	67,660	71,302	74,939	78,582	91,465
ATEN-120-[]	120			59,397	67,660	71,302	74,939	78,582	82,223	95,107
ATEN-132-[]	132				75,919	79,561	83,205	86,840	90,484	103,370
ATEN-144-[]	144					83,205	86,840	90,484	94,127	107,009
ATEN-156-[]	156						90,484	94,127	97,763	110,650
ATEN-168-[]	168							97,763	101,405	114,290
ATEN-180-[]	180								105,045	117,931
ATEN-192-[]	192									130,908

204"-360" LONG

LENGTH [B]

MODEL #	WIDTH [A]	204" [204]	216" [216]	228" [228]	240" [240]	264" [264]	288" [288]	312" [312]	336" [336]	360" [360]
ATEN-96-[]	96	91,465	95,102	98,746	102,386	109,670	116,947	124,229	136,135	143,415
ATEN-108-[]	108	95,107	98,746	102,386	106,028	113,305	120,591	127,870	139,772	147,057
ATEN-120-[]	120	98,746	102,386	106,028	109,670	116,947	124,229	131,514	143,415	150,696
ATEN-132-[]	132	107,009	110,650	114,290	117,931	125,209	132,494	139,772	151,771	159,054
ATEN-144-[]	144	110,650	114,290	117,931	121,570	128,853	134,497	143,415	155,416	162,697
ATEN-156-[]	156	114,290	117,931	121,570	125,209	132,494	139,772	147,057	159,054	166,335
ATEN-168-[]	168	117,931	121,570	125,209	128,853	136,135	143,415	150,696	162,697	169,978
ATEN-180-[]	180	121,570	125,209	128,853	132,494	139,772	147,057	154,336	166,335	173,617
ATEN-192-[]	192	134,552	138,191	141,829	145,473	152,751	160,038	167,316	179,220	186,503
ATEN-204-[]	204	138,191	141,829	145,473	149,114	156,394	163,675	170,956	182,860	190,142
ATEN-216-[]	216		145,473	149,114	152,751	160,038	167,316	174,600	186,503	193,782
ATEN-228-[]	228			152,751	156,394	163,675	170,956	178,236	190,142	197,424
ATEN-240-[]	240				160,038	167,316	174,600	181,878	193,782	201,061
ATEN-264-[]	264					174,600	181,878	189,162	201,061	208,346
ATEN-288-[]	288						189,162	196,440	208,346	215,626
ATEN-312-[]	312							203,725	215,626	222,908
ATEN-336-[]	336								227,527	234,809
ATEN-360-[]	360									242,089



VENEER TOP WITH HARDWOOD EDGE / WOOD DOOR POWER MATRIX

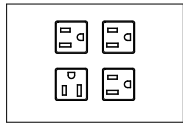

-FOUR

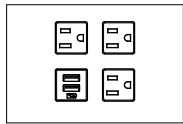

-THREE-C

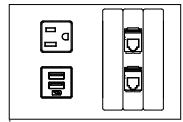

-USB-C

OPTIONS	CODE	NOTES
4 Simplex Receptacles	Add -FOUR	Replace Modular AV Inserts/Plates with 2 simplex receptacles
3 Simplex Receptacles/Charging USB-A+C	Add -THREE-C	Replace Modular AV Inserts/Plates with 1 simplex receptacle and 1 charging USB-A+C
USB-A+C Charging	Add -USB-C	USB-A+C charger, replaces one simplex receptacle per Power Matrix Unit. Refer to pages 16-17 to determine how much to add based on table size.
Field-Wired	Add -FW	Refer to pages 16-17 to determine how much to deduct based on table size. The city of Chicago may require hardwiring of components and may not allow the use of standard modular power systems. A junction box will be provided when ordering the -FW option.

EDGE PROFILE



Double Bevel Edge

GENERAL INFORMATION

- Tops are 1-1/4" thick
- Overall table height 29-1/2"
- Access Door is standard on enclosed Ativa tables and is located on one of the four sides of square tables and on one of the short sides of rectangle tables
- All Power Matrix interior components are clear anodized aluminum
- Quantity of Power Matrix units is dependent on table dimensions. See pages 16-17 for more information.

REQUIRED INFORMATION (ORDER CANNOT BE ENTERED WITHOUT THIS INFORMATION)

See appendix page vi for surface material options.

- Choose Veneer Finish
- Choose Metal Finish
- Choose Power Matrix Door Material: Wood (-W)

RETRACTORS

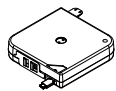

CR-HDMI

MODEL #	DESCRIPTION	PRICE
CR-CAT6	CAT6 Retractor	996
CR-HDMI	HDMI Retractor	996
CR-DISPLAY	Display Port Retractor	996
CR-USB	Data USB Retractor	996

GENERAL INFORMATION

- Mounting bracket and attaching hardware included with each retractor
- Can only be used with Power Matrix Small or Medium units
- One Cable Pass Through Set (one top, one bottom) Modular AV Insert/Plate included. Double style Modular AV Inserts/Plates.
- Limited to two retractor units inside of the modesty panels



VENEER TOP WITH HARDWOOD EDGE

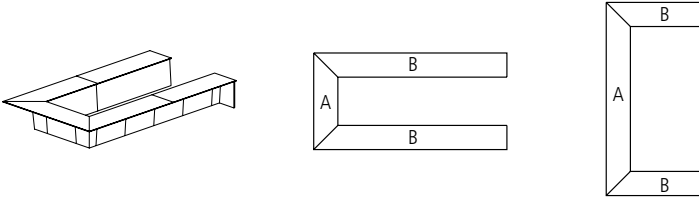

96"-192" LONG

LENGTH [B]

MODEL #	WIDTH [A]	96" [96]	108" [108]	120" [120]	132" [132]	144" [144]	156" [156]	168" [168]	180" [180]	192" [192]
ATUS-96-[]	96	32,408	36,050	39,694	43,338	46,982	50,627	54,270	57,914	61,557
ATUS-108-[]	108	34,228	37,871	41,516	45,159	48,805	52,446	56,091	59,735	63,380
ATUS-120-[]	120	36,050	39,694	43,338	46,982	50,627	54,270	57,914	61,557	65,201
ATUS-132-[]	132	37,871	41,516	45,159	48,805	52,446	56,091	59,735	63,380	67,021
ATUS-144-[]	144	39,694	43,338	46,982	50,627	54,270	57,914	61,557	65,201	68,843
ATUS-156-[]	156	41,516	45,159	48,805	52,446	56,091	59,735	63,380	67,021	70,667
ATUS-168-[]	168	43,338	46,982	50,627	54,270	57,914	61,557	65,201	68,843	72,487
ATUS-180-[]	180	45,159	48,805	52,446	56,091	59,735	63,380	67,021	70,667	74,312
ATUS-192-[]	192	46,982	50,627	54,270	57,914	61,557	65,201	68,843	72,487	76,132
ATUS-204-[]	204	48,805	52,446	56,091	59,735	63,380	67,021	70,667	74,312	77,954
ATUS-216-[]	216	50,627	54,270	57,914	61,557	65,201	68,843	72,487	76,132	79,775
ATUS-228-[]	228	52,446	56,091	59,735	63,380	67,021	70,667	74,312	77,954	81,599
ATUS-240-[]	240	54,270	57,914	61,557	65,201	68,843	72,487	76,132	79,775	83,420
ATUS-264-[]	264	57,914	61,557	65,201	68,843	72,487	76,132	79,775	83,420	87,065
ATUS-288-[]	288	61,557	65,201	68,843	72,487	76,132	79,775	83,420	87,065	90,707
ATUS-312-[]	312	65,201	68,843	72,487	76,132	79,775	83,420	87,065	90,707	94,350
ATUS-336-[]	336	68,843	72,487	76,132	79,775	83,420	87,065	90,707	94,350	97,994
ATUS-360-[]	360	72,487	76,132	79,775	83,420	87,065	90,707	94,350	97,994	101,640

204"-360" LONG

LENGTH [B]

MODEL #	WIDTH [A]	204" [204]	216" [216]	228" [228]	240" [240]	264" [264]	288" [288]	312" [312]	336" [336]	360" [360]
ATUS-96-[]	96	65,201	68,843	72,487	76,132	83,420	90,707	97,994	105,283	112,568
ATUS-108-[]	108	67,021	70,667	74,312	77,954	85,241	92,529	99,814	107,105	114,391
ATUS-120-[]	120	68,843	72,487	76,132	79,775	87,065	94,350	101,640	108,927	116,214
ATUS-132-[]	132	70,667	74,312	77,954	81,599	88,884	96,174	103,460	110,750	118,036
ATUS-144-[]	144	72,487	76,132	79,775	83,420	90,707	97,994	105,283	112,568	119,859
ATUS-156-[]	156	74,312	77,954	81,599	85,241	92,529	99,814	107,105	114,391	121,679
ATUS-168-[]	168	76,132	79,775	83,420	87,065	94,350	101,640	108,927	116,214	123,501
ATUS-180-[]	180	77,954	81,599	85,241	88,884	96,174	103,460	110,750	118,036	125,326
ATUS-192-[]	192	79,775	83,420	87,065	90,707	97,994	105,283	112,568	119,859	127,146
ATUS-204-[]	204	81,599	85,241	88,884	92,529	99,814	107,105	114,391	121,679	128,967
ATUS-216-[]	216	83,420	87,065	90,707	94,350	101,640	108,927	116,214	123,501	130,791
ATUS-228-[]	228	85,241	88,884	92,529	96,174	103,460	110,750	118,036	125,326	132,610
ATUS-240-[]	240	87,065	90,707	94,350	97,994	105,283	112,568	119,859	127,146	134,434
ATUS-264-[]	264	90,707	94,350	97,994	101,640	108,927	116,214	123,501	130,791	138,077
ATUS-288-[]	288	94,350	97,994	101,640	105,283	112,568	119,859	127,146	134,434	141,722
ATUS-312-[]	312	97,994	101,640	105,283	108,927	116,214	123,501	130,791	138,077	145,365
ATUS-336-[]	336	101,640	105,283	108,927	112,568	119,859	127,146	134,434	141,722	149,011
ATUS-360-[]	360	105,283	108,927	112,568	116,214	123,501	130,791	138,077	145,365	152,654

EDGE PROFILE



Double Bevel Edge

GENERAL INFORMATION

- Tops are 1-1/4" thick
- Overall table height 29-1/2"
- Corner metal accent pieces will default to clear anodized aluminum if metal finish is not specified

REQUIRED INFORMATION (ORDER CANNOT BE ENTERED WITHOUT THIS INFORMATION)

See appendix page vi for surface material options.

- Choose Veneer Finish
- Choose Metal Finish



INSET LAMINATE TOP WITH HARDWOOD EDGE

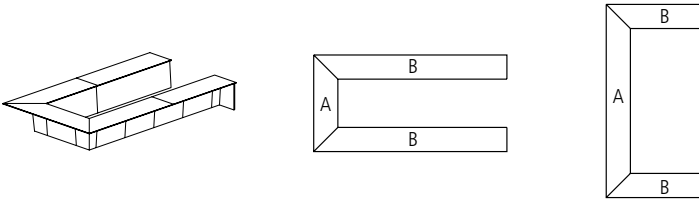

96"-192" LONG

MODEL #	WIDTH [A]	LENGTH [B]								
		96" [96]	108" [108]	120" [120]	132" [132]	144" [144]	156" [156]	168" [168]	180" [180]	192" [192]
ATUS-96-[]-P	96	30,951	34,429	37,909	41,388	44,870	48,347	51,827	55,309	58,788
ATUS-108-[]-P	108	32,688	36,171	39,650	43,128	46,609	50,087	53,569	57,046	60,527
ATUS-120-[]-P	120	34,429	37,909	41,388	44,870	48,347	51,827	55,309	58,788	62,270
ATUS-132-[]-P	132	36,171	39,650	43,128	46,609	50,087	53,569	57,046	60,527	64,008
ATUS-144-[]-P	144	37,909	41,388	44,870	48,347	51,827	55,309	58,788	62,270	65,747
ATUS-156-[]-P	156	39,650	43,128	46,609	50,087	53,569	57,046	60,527	64,008	67,487
ATUS-168-[]-P	168	41,388	44,870	48,347	51,827	55,309	58,788	62,270	65,747	69,229
ATUS-180-[]-P	180	43,128	46,609	50,087	53,569	57,046	60,527	64,008	67,487	70,967
ATUS-192-[]-P	192	44,870	48,347	51,827	55,309	58,788	62,270	65,747	69,229	72,708
ATUS-204-[]-P	204	46,609	50,087	53,569	57,046	60,527	64,008	67,487	70,967	74,450
ATUS-216-[]-P	216	48,347	51,827	55,309	58,788	62,270	65,747	69,229	72,708	76,185
ATUS-228-[]-P	228	50,087	53,569	57,046	60,527	64,008	67,487	70,967	74,450	77,928
ATUS-240-[]-P	240	51,827	55,309	58,788	62,270	65,747	69,229	72,708	76,185	79,668
ATUS-264-[]-P	264	55,309	58,788	62,270	65,747	69,229	72,708	76,185	79,668	83,146
ATUS-288-[]-P	288	58,788	62,270	65,747	69,229	72,708	76,185	79,668	83,146	86,627
ATUS-312-[]-P	312	62,270	65,747	69,229	72,708	76,185	79,668	83,146	86,627	90,105
ATUS-336-[]-P	336	65,747	69,229	72,708	76,185	79,668	83,146	86,627	90,105	93,585
ATUS-360-[]-P	360	69,229	72,708	76,185	79,668	83,146	86,627	90,105	93,585	97,067

204"-360" LONG

MODEL #	WIDTH [A]	LENGTH [B]								
		204" [204]	216" [216]	228" [228]	240" [240]	264" [264]	288" [288]	312" [312]	336" [336]	360" [360]
ATUS-96-[]-P	96	62,270	65,747	69,229	72,708	79,668	86,627	93,585	100,548	107,506
ATUS-108-[]-P	108	64,008	67,487	70,967	74,450	81,407	88,367	95,326	102,285	109,244
ATUS-120-[]-P	120	65,747	69,229	72,708	76,185	83,146	90,105	97,067	104,026	110,986
ATUS-132-[]-P	132	67,487	70,967	74,450	77,928	84,887	91,846	98,805	105,766	112,726
ATUS-144-[]-P	144	69,229	72,708	76,185	79,668	86,627	93,585	100,548	107,506	114,465
ATUS-156-[]-P	156	70,967	74,450	77,928	81,407	88,367	95,326	102,285	109,244	116,206
ATUS-168-[]-P	168	72,708	76,185	79,668	83,146	90,105	97,067	104,026	110,986	117,945
ATUS-180-[]-P	180	74,450	77,928	81,407	84,887	91,846	98,805	105,766	112,726	119,686
ATUS-192-[]-P	192	76,185	79,668	83,146	86,627	93,585	100,548	107,506	114,465	121,424
ATUS-204-[]-P	204	77,928	81,407	84,887	88,367	95,326	102,285	109,244	116,206	123,165
ATUS-216-[]-P	216	79,668	83,146	86,627	90,105	97,067	104,026	110,986	117,945	124,903
ATUS-228-[]-P	228	81,407	84,887	88,367	91,846	98,805	105,766	112,726	119,686	126,645
ATUS-240-[]-P	240	83,146	86,627	90,105	93,585	100,548	107,506	114,465	121,424	128,386
ATUS-264-[]-P	264	86,627	90,105	93,585	97,067	104,026	110,986	117,945	124,903	131,864
ATUS-288-[]-P	288	90,105	93,585	97,067	100,548	107,506	114,465	121,424	128,386	135,344
ATUS-312-[]-P	312	93,585	97,067	100,548	104,026	110,986	117,945	124,903	131,864	138,823
ATUS-336-[]-P	336	97,067	100,548	104,026	107,506	114,465	121,424	128,386	135,344	142,305
ATUS-360-[]-P	360	100,548	104,026	107,506	110,986	117,945	124,903	131,864	138,823	145,785

EDGE PROFILE



Double Bevel Edge

GENERAL INFORMATION

- Tops are 1-1/4" thick
- Overall table height 29-1/2"
- Corner metal accent pieces will default to clear anodized aluminum if metal finish is not specified

REQUIRED INFORMATION (ORDER CANNOT BE ENTERED WITHOUT THIS INFORMATION)

- See appendix page vi for surface material options.
- Choose Veneer Finish
 - Choose Laminate (Wood-grain laminate not available)
 - Choose Metal Finish



VENEER TOP WITH HARDWOOD EDGE / GLASS OR METAL DOOR POWER MATRIX

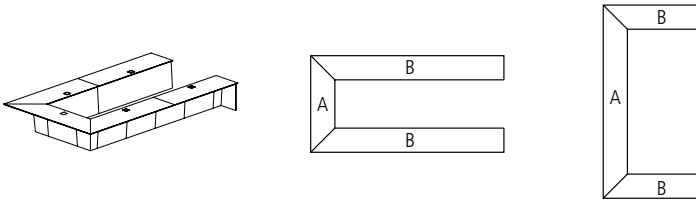

96"-192" LONG

LENGTH [B]

MODEL #	WIDTH [A]	96" [96]	108" [108]	120" [120]	132" [132]	144" [144]	156" [156]	168" [168]	180" [180]	192" [192]
ATUS-96-[]	96	37,952	41,594	45,235	52,593	56,235	59,877	63,519	67,157	78,241
ATUS-108-[]	108	39,772	43,411	47,055	54,414	58,058	61,699	65,336	68,979	80,060
ATUS-120-[]	120	41,594	45,235	48,873	56,235	59,877	63,519	67,157	70,800	81,878
ATUS-132-[]	132	46,909	48,916	52,555	59,918	63,556	67,199	70,841	74,485	85,564
ATUS-144-[]	144	47,094	50,733	54,376	61,738	65,380	69,021	72,660	76,300	87,384
ATUS-156-[]	156	48,916	52,555	56,194	63,556	67,199	70,841	74,485	78,119	89,203
ATUS-168-[]	168	50,733	54,376	58,015	65,380	69,021	72,660	76,300	79,899	91,026
ATUS-180-[]	180	52,555	56,194	59,836	67,199	70,841	74,485	78,119	81,763	92,844
ATUS-192-[]	192	58,097	61,738	65,380	72,739	76,380	80,021	83,661	87,304	98,389
ATUS-204-[]	204	59,918	63,556	67,199	74,561	78,200	81,840	85,480	89,123	100,204
ATUS-216-[]	216	61,738	65,380	69,021	76,380	80,021	83,661	87,304	90,944	102,027
ATUS-228-[]	228	63,556	67,199	70,841	78,200	81,840	85,480	89,123	92,762	103,845
ATUS-240-[]	240	65,380	69,021	72,660	80,021	83,661	87,304	90,944	94,581	105,666
ATUS-264-[]	264	69,021	72,660	76,300	83,661	87,304	90,944	94,581	98,224	109,306
ATUS-288-[]	288	72,660	76,300	79,944	87,304	90,944	94,581	98,224	101,864	112,951
ATUS-312-[]	312	76,300	79,944	83,582	90,944	94,581	98,224	101,864	105,504	116,586
ATUS-336-[]	336	81,804	85,443	89,085	96,443	100,084	103,724	107,366	111,007	122,186
ATUS-360-[]	360	85,443	89,085	92,724	100,084	103,724	107,366	111,007	114,646	125,827

204"-360" LONG

LENGTH [B]

MODEL #	WIDTH [A]	204" [204]	216" [216]	228" [228]	240" [240]	264" [264]	288" [288]	312" [312]	336" [336]	360" [360]
ATUS-96-[]	96	81,878	85,523	89,163	92,804	100,084	107,366	114,646	125,650	132,934
ATUS-108-[]	108	83,703	87,343	90,981	94,623	101,903	109,187	116,466	127,472	134,751
ATUS-120-[]	120	85,523	89,163	92,804	96,443	103,724	111,007	118,288	129,292	136,571
ATUS-132-[]	132	89,203	92,844	96,484	100,126	107,405	114,688	121,971	83,874	140,253
ATUS-144-[]	144	91,026	94,667	98,303	101,944	109,230	116,507	123,787	134,790	142,077
ATUS-156-[]	156	92,844	96,484	100,126	103,764	111,049	118,327	125,610	136,616	143,895
ATUS-168-[]	168	94,667	98,303	101,944	105,586	112,865	120,151	127,429	138,432	145,713
ATUS-180-[]	180	96,484	100,126	103,764	107,405	114,688	121,971	129,253	140,253	147,537
ATUS-192-[]	192	102,027	105,666	109,306	112,951	120,229	127,511	134,790	145,893	153,173
ATUS-204-[]	204	103,845	107,487	111,126	114,768	122,052	129,330	136,616	147,714	154,995
ATUS-216-[]	216	105,666	109,306	112,951	116,586	123,872	131,154	138,432	149,532	156,815
ATUS-228-[]	228	107,487	111,126	114,768	118,409	125,690	132,975	140,253	151,353	158,636
ATUS-240-[]	240	109,306	112,951	116,586	120,229	127,511	134,790	142,077	153,173	160,454
ATUS-264-[]	264	112,951	116,586	120,229	123,872	131,154	138,432	145,713	156,815	164,095
ATUS-288-[]	288	116,586	120,229	123,872	127,511	134,790	142,077	149,356	160,454	167,739
ATUS-312-[]	312	120,229	123,872	127,511	131,154	139,906	145,713	152,998	164,095	171,377
ATUS-336-[]	336	125,827	129,469	133,108	136,750	144,029	151,313	158,595	169,594	176,879
ATUS-360-[]	360	129,525	133,170	136,812	140,449	147,734	155,018	162,299	173,310	180,591



VENEER TOP WITH HARDWOOD EDGE / GLASS OR METAL DOOR POWER MATRIX

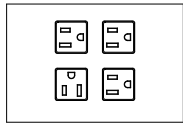

-FOUR

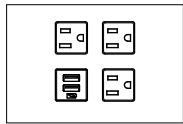

-THREE-C

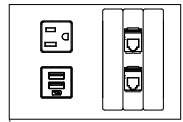

-USB-C

OPTIONS	CODE	NOTES
4 Simplex Receptacles	Add -FOUR	Replace Modular AV Inserts/Plates with 2 simplex receptacles
3 Simplex Receptacles/Charging USB-A+C	Add -THREE-C	Replace Modular AV Inserts/Plates with 1 simplex receptacle and 1 charging USB-A+C
USB-A+C Charging	Add -USB-C	USB-A+C charger, replaces one simplex receptacle per Power Matrix Unit. Refer to pages 16-17 to determine how much to add based on table size.
Polished Chrome Door	Add -PD	Only available with metal door option. Refer to pages 16-17 to determine how much to add based on table size.
Field-Wired	Add -FW	Refer to pages 16-17 to determine how much to deduct based on table size. The city of Chicago may require hardwiring of components and may not allow the use of standard modular power systems. A junction box will be provided when ordering the -FW option.

EDGE PROFILE



Double Bevel Edge

GENERAL INFORMATION

- Tops are 1-1/4" thick
- Overall table height 29-1/2"
- Power Matrix glass doors are back-painted 1/4" optically clear, low-iron glass
- All Power Matrix interior components are clear anodized aluminum
- When specified with metal Power Matrix doors, the color of the metal trim on the table top and modesty panels will match the Power Matrix door finish
- When specified with glass Power Matrix doors, the metal trim will be clear anodized aluminum
- Quantity of Power Matrix units is dependent on table dimensions. See pages 16-17 for more information.

REQUIRED INFORMATION (ORDER CANNOT BE ENTERED WITHOUT THIS INFORMATION)

See appendix page vi for surface material options.

- Choose Veneer Finish
- Choose Metal Finish
- Choose Power Matrix Door Material: Metal (-M) or Glass (-G)
- Choose Power Matrix Metal Door Finish, if -M is specified
- Choose Power Matrix Glass Door Finish, if -G is specified

RETRACTORS

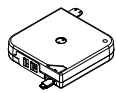

CR-HDMI

MODEL #	DESCRIPTION	PRICE
CR-CAT6	CAT6 Retractor	996
CR-HDMI	HDMI Retractor	996
CR-DISPLAY	Display Port Retractor	996
CR-USB	Data USB Retractor	996

GENERAL INFORMATION

- Mounting bracket and attaching hardware included with each retractor
- Can only be used with Power Matrix Small or Medium units
- One Cable Pass Through Set (one top, one bottom) Modular AV Insert/Plate included. Double style Modular AV Inserts/Plates.
- Limited to two retractor units inside of the modesty panels



INSET LAMINATE TOP WITH HARDWOOD EDGE / GLASS OR METAL DOOR POWER MATRIX

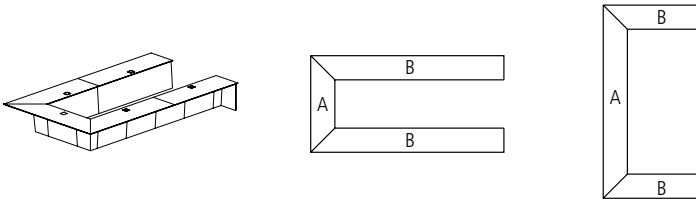

96"-192" LONG

LENGTH [B]

MODEL #	WIDTH [A]	96" [96]	108" [108]	120" [120]	132" [132]	144" [144]	156" [156]	168" [168]	180" [180]	192" [192]
ATUS-96-[]-P	96	36,494	39,973	43,450	50,650	54,125	57,602	61,080	64,556	75,474
ATUS-108-[]-P	108	38,232	41,709	45,189	52,387	55,864	59,341	62,818	66,294	77,211
ATUS-120-[]-P	120	39,973	43,450	46,926	54,125	57,602	61,080	64,556	68,032	78,951
ATUS-132-[]-P	132	43,571	47,050	50,524	57,724	61,201	64,679	68,155	71,630	82,551
ATUS-144-[]-P	144	45,311	48,788	52,266	59,460	62,942	66,417	69,895	73,370	84,288
ATUS-156-[]-P	156	46,608	50,524	54,001	61,201	64,679	68,155	71,630	75,107	86,028
ATUS-168-[]-P	168	48,788	52,266	55,744	62,942	66,417	69,895	73,370	76,849	87,765
ATUS-180-[]-P	180	50,524	54,001	57,479	64,679	68,155	71,630	75,107	78,584	89,504
ATUS-192-[]-P	192	55,984	59,460	62,942	70,137	73,611	77,087	80,568	84,043	94,965
ATUS-204-[]-P	204	57,724	61,201	64,679	71,877	75,354	78,827	82,304	85,781	96,702
ATUS-216-[]-P	216	59,460	62,942	66,417	73,611	77,087	80,568	84,043	87,521	98,439
ATUS-228-[]-P	228	61,201	64,679	68,155	75,354	78,827	82,304	85,781	89,256	100,179
ATUS-240-[]-P	240	62,942	66,417	69,895	77,087	80,568	84,043	87,521	90,996	101,918
ATUS-264-[]-P	264	66,417	69,895	73,370	80,568	84,043	92,431	90,996	94,475	105,394
ATUS-288-[]-P	288	69,895	73,370	76,849	84,043	87,521	90,996	94,475	97,949	108,870
ATUS-312-[]-P	312	73,370	76,849	80,325	87,521	90,996	94,475	97,949	101,430	112,349
ATUS-336-[]-P	336	78,707	82,184	85,663	92,856	96,334	99,811	103,287	106,765	117,780
ATUS-360-[]-P	360	82,184	85,663	89,136	96,334	99,811	103,287	106,765	110,241	121,259

204"-360" LONG

LENGTH [B]

MODEL #	WIDTH [A]	204" [204]	216" [216]	228" [228]	240" [240]	264" [264]	288" [288]	312" [312]	336" [336]	360" [360]
ATUS-96-[]-P	96	78,951	82,430	85,904	89,381	96,334	103,287	110,241	120,916	127,871
ATUS-108-[]-P	108	80,687	84,165	87,645	91,120	98,074	105,029	111,981	122,657	129,611
ATUS-120-[]-P	120	82,430	85,904	89,381	92,856	99,811	106,765	113,717	124,394	131,347
ATUS-132-[]-P	132	86,028	89,504	92,981	96,456	103,412	110,364	117,318	127,995	134,948
ATUS-144-[]-P	144	87,765	91,243	94,721	98,196	105,150	112,103	119,055	129,733	136,688
ATUS-156-[]-P	156	89,504	92,981	96,456	99,935	106,888	113,840	120,795	131,471	138,426
ATUS-168-[]-P	168	91,243	94,721	98,196	101,672	108,629	115,579	122,532	133,209	140,165
ATUS-180-[]-P	180	92,981	96,456	99,935	103,412	110,364	117,318	124,272	134,948	141,902
ATUS-192-[]-P	192	98,439	101,918	105,394	108,870	115,825	122,777	129,733	140,506	147,458
ATUS-204-[]-P	204	100,179	103,655	107,134	110,611	117,562	124,518	131,471	142,243	149,198
ATUS-216-[]-P	216	101,918	105,394	108,870	112,349	119,302	126,256	133,209	143,983	150,936
ATUS-228-[]-P	228	103,655	107,134	110,611	114,089	121,041	127,995	134,948	145,721	152,675
ATUS-240-[]-P	240	105,394	108,870	112,349	115,825	122,777	129,733	136,688	147,458	154,411
ATUS-264-[]-P	264	108,870	112,349	115,825	119,302	126,256	133,209	140,165	150,936	157,888
ATUS-288-[]-P	288	112,349	115,825	119,302	122,777	129,733	136,688	143,639	154,411	164,843
ATUS-312-[]-P	312	115,825	119,302	122,777	126,256	133,209	140,165	147,115	157,888	164,843
ATUS-336-[]-P	336	121,259	124,736	128,214	131,690	138,644	145,601	152,552	163,224	170,179
ATUS-360-[]-P	360	124,736	128,214	131,690	135,168	142,120	149,075	156,029	166,798	173,753



INSET LAMINATE TOP TOP WITH HARDWOOD EDGE / GLASS OR METAL DOOR POWER MATRIX

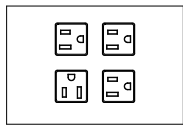

-FOUR

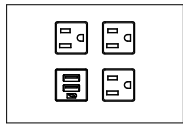

-THREE-C

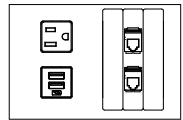

-USB-C

OPTIONS	CODE	NOTES
4 Simplex Receptacles	Add -FOUR	Replace Modular AV Inserts/Plates with 2 simplex receptacles
3 Simplex Receptacles/Charging USB-A+C	Add -THREE-C	Replace Modular AV Inserts/Plates with 1 simplex receptacle and 1 charging USB-A+C
USB-A+C Charging	Add -USB-C	USB-A+C charger, replaces one simplex receptacle per Power Matrix Unit. Refer to pages 16-17 to determine how much to add based on table size.
Polished Chrome Door	Add -PD	Only available with metal door option. Refer to pages 16-17 to determine how much to add based on table size.
Polished Chrome Bezel	Add -PB	Only available on laminate top tables. Refer to pages 16-17 to determine how much to add based on table size.
Field-Wired	Add -FW	Refer to pages 16-17 to determine how much to deduct based on table size. The city of Chicago may require hardwiring of components and may not allow the use of standard modular power systems. A junction box will be provided when ordering the -FW option.

EDGE PROFILE



Double Bevel Edge

GENERAL INFORMATION

- Tops are 1-1/4" thick
- Overall table height 29-1/2"
- Power Matrix glass doors are back-painted 1/4" optically clear, low-iron glass
- All Power Matrix interior components are clear anodized aluminum
- When specified with metal Power Matrix doors, the color of the metal trim on the table top and modesty panels will match the Power Matrix door finish
- When specified with glass Power Matrix doors, the metal trim will be clear anodized aluminum
- Each Power Matrix unit includes a 3/8"-wide metal bezel
- Quantity of Power Matrix units is dependent on table dimensions. See pages 16-17 for more information.

REQUIRED INFORMATION (ORDER CANNOT BE ENTERED WITHOUT THIS INFORMATION)

See appendix page vi for surface material options.

- Choose Veneer Finish
- Choose Laminate (Wood-grain laminate not available)
- Choose Metal Finish
- Choose Power Matrix Door Material: Metal (-M) or Glass (-G)
- Choose Power Matrix Metal Door Finish, if -M is specified
- Choose Power Matrix Glass Door Finish, if -G is specified

RETRACTORS

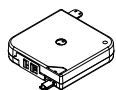

CR-HDMI

MODEL #	DESCRIPTION	PRICE
CR-CAT6	CAT6 Retractor	996
CR-HDMI	HDMI Retractor	996
CR-DISPLAY	Display Port Retractor	996
CR-USB	Data USB Retractor	996

GENERAL INFORMATION

- Mounting bracket and attaching hardware included with each retractor
- Can only be used with Power Matrix Small or Medium units
- One Cable Pass Through Set (one top, one bottom) Modular AV Insert/Plate included. Double style Modular AV Inserts/Plates.
- Limited to two retractor units inside of the modesty panels



VENEER TOP WITH HARDWOOD EDGE / WOOD DOOR POWER MATRIX

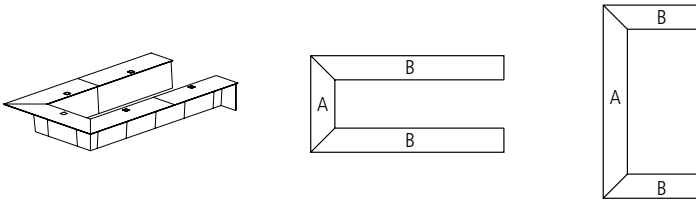

96"-192" LONG

LENGTH [B]

MODEL #	WIDTH [A]	96" [96]	108" [108]	120" [120]	132" [132]	144" [144]	156" [156]	168" [168]	180" [180]	192" [192]
ATUS-96-[]	96	39,303	42,942	46,583	54,847	58,487	62,127	65,769	69,410	82,293
ATUS-108-[]	108	41,124	44,762	48,404	56,665	60,306	63,949	67,587	71,229	84,112
ATUS-120-[]	120	42,942	46,583	50,225	58,487	62,127	65,769	69,410	73,050	85,933
ATUS-132-[]	132	47,074	50,713	54,355	62,618	66,260	66,625	73,538	77,181	90,064
ATUS-144-[]	144	48,894	52,534	56,179	64,439	68,080	71,717	75,361	79,001	91,886
ATUS-156-[]	156	50,713	54,355	57,996	66,260	69,901	73,538	77,181	80,820	93,705
ATUS-168-[]	168	52,534	56,179	59,816	68,080	71,717	75,361	79,001	82,643	95,523
ATUS-180-[]	180	54,355	57,996	61,635	69,901	73,538	77,181	80,820	84,463	97,343
ATUS-192-[]	192	60,797	64,439	68,080	76,340	79,981	83,622	87,262	90,906	103,788
ATUS-204-[]	204	62,618	66,260	69,901	78,160	81,803	85,442	89,082	92,724	105,606
ATUS-216-[]	216	64,439	68,080	71,717	79,981	83,622	87,262	90,906	94,544	107,427
ATUS-228-[]	228	66,260	69,901	73,538	81,803	85,442	89,082	92,724	96,364	109,249
ATUS-240-[]	240	68,080	71,717	75,361	83,622	87,262	90,906	94,544	98,182	111,069
ATUS-264-[]	264	71,717	75,361	79,001	87,262	90,906	94,544	98,182	101,825	114,709
ATUS-288-[]	288	75,361	79,001	82,643	90,906	94,503	98,182	101,825	105,465	118,351
ATUS-312-[]	312	79,001	82,643	86,283	94,544	98,182	101,825	105,465	109,104	121,989
ATUS-336-[]	336	84,954	88,593	92,235	100,491	104,134	107,777	111,417	115,058	128,037
ATUS-360-[]	360	88,593	92,235	95,872	104,134	107,777	111,417	115,058	118,697	131,676

204"-360" LONG

LENGTH [B]

MODEL #	WIDTH [A]	204" [204]	216" [216]	228" [228]	240" [240]	264" [264]	288" [288]	312" [312]	336" [336]	360" [360]
ATUS-96-[]	96	85,933	89,573	92,624	96,858	104,134	111,417	118,697	130,601	137,885
ATUS-108-[]	108	87,753	91,393	95,036	98,675	105,956	113,237	120,517	132,424	139,701
ATUS-120-[]	120	89,573	92,624	96,858	100,491	107,777	115,058	122,338	134,242	141,522
ATUS-132-[]	132	93,705	97,343	100,984	104,625	111,906	119,190	126,471	138,375	145,653
ATUS-144-[]	144	95,523	99,166	102,805	106,446	113,729	121,008	128,291	140,194	147,476
ATUS-156-[]	156	97,343	100,970	104,625	108,265	115,546	122,829	130,112	142,014	149,297
ATUS-168-[]	168	99,166	102,805	106,446	110,086	117,367	124,647	131,930	143,835	151,117
ATUS-180-[]	180	100,984	104,625	108,265	111,906	119,190	126,471	133,751	145,653	152,938
ATUS-192-[]	192	107,427	111,069	114,709	118,351	125,630	132,913	140,194	152,194	159,476
ATUS-204-[]	204	109,249	112,888	116,528	120,168	127,453	134,731	142,014	154,014	161,296
ATUS-216-[]	216	111,069	114,709	118,351	121,989	129,272	136,551	143,835	155,833	163,114
ATUS-228-[]	228	112,888	116,528	120,168	123,812	131,092	138,375	145,653	157,657	164,936
ATUS-240-[]	240	114,709	118,351	121,989	125,630	132,913	140,194	147,476	159,476	166,757
ATUS-264-[]	264	118,351	121,989	125,630	129,272	136,551	143,835	151,117	163,114	170,399
ATUS-288-[]	288	121,989	125,630	129,272	132,913	140,194	147,476	154,756	166,757	174,039
ATUS-312-[]	312	125,630	129,272	132,913	136,551	143,835	151,117	158,397	170,399	177,679
ATUS-336-[]	336	131,676	135,320	138,960	142,602	149,881	157,165	164,449	176,350	183,627
ATUS-360-[]	360	135,320	138,960	142,602	146,241	153,523	160,803	168,084	179,988	187,265



VENEER TOP WITH HARDWOOD EDGE / WOOD DOOR POWER MATRIX

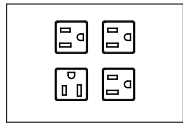

-FOUR

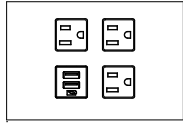

-THREE-C

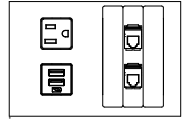

-USB-C

OPTIONS	CODE	NOTES
4 Simplex Receptacles	Add -FOUR	Replace Modular AV Inserts/Plates with 2 simplex receptacles
3 Simplex Receptacles/Charging USB-A+C	Add -THREE-C	Replace Modular AV Inserts/Plates with 1 simplex receptacle and 1 charging USB-A+C
USB-A+C Charging	Add -USB-C	USB-A+C charger, replaces one simplex receptacle per Power Matrix Unit. Refer to pages 16-17 to determine how much to add based on table size.
Field-Wired	Add -FW	Refer to pages 16-17 to determine how much to deduct based on table size. The city of Chicago may require hardwiring of components and may not allow the use of standard modular power systems. A junction box will be provided when ordering the -FW option.

EDGE PROFILE



Double Bevel Edge

GENERAL INFORMATION

- Tops are 1-1/4" thick
- Overall table height 29-1/2"
- All Power Matrix interior components are clear anodized aluminum
- Quantity of Power Matrix units is dependent on table dimensions. See pages 16-17 for more information.
- Corner metal accent pieces will default to clear anodized aluminum if metal finish is not specified

REQUIRED INFORMATION (ORDER CANNOT BE ENTERED WITHOUT THIS INFORMATION)

See appendix page vi for surface material options.

- Choose Veneer Finish
- Choose Metal Finish
- Choose Power Matrix Door Material: Wood (-W)

RETRACTORS	MODEL #	DESCRIPTION	PRICE
<p>CR-HDMI</p>	CR-CAT6	CAT6 Retractor	996
	CR-HDMI	HDMI Retractor	996
	CR-DISPLAY	Display Port Retractor	996
	CR-USB	Data USB Retractor	996

GENERAL INFORMATION

- Mounting bracket and attaching hardware included with each retractor
- Can only be used with Power Matrix Small or Medium units
- One Cable Pass Through Set (one top, one bottom) Modular AV Insert/Plate included. Double style Modular AV Inserts/Plates.
- Limited to two retractor units inside of the modesty panels



DATA FACEPLATES AND FREESTANDING POWER OPTION

DATA FACEPLATES	MODEL #	DESCRIPTION	STYLE	W x H	PRICE
	FLDF-1	Blank faceplate, single height	Single	3-1/2 x 5/8	81
	FLDF-2	One VGA 15-pin HD Female to Female Gender Changer, one 3.5mm Stereo Mini Jack to Solder Tabs	Single	3-1/2 x 5/8	284
	FLDF-3	One VGA 15-pin HD Female to Female Gender Changer	Single	3-1/2 x 5/8	223
	FLDF-4	One RJ-11 Female to Punch Down - Phone	Single	3-1/2 x 5/8	223
	FLDF-5	One RJ-45 Female to Female Barrel - Data	Single	3-1/2 x 5/8	182
	FLDF-6	Two RJ-45 Female to Female Barrels, single height	Single	3-1/2 x 5/8	244
	FLDF-7	Two RJ-45 Female to Punch Down for CAT 6 - AMP	Single	3-1/2 x 5/8	345
	FLDF-8	Two RJ-45 Female to Punch Down for CAT 6 - Leviton	Single	3-1/2 x 5/8	345
	FLDF-10	Two RJ-45 Female to Punch Down for CAT 6 - Panduit	Single	3-1/2 x 5/8	345
	FLDF-11	Two USB A Female to Two USB A Female on 10" Pigtails	Single	3-1/2 x 5/8	386
	FLDF-12	Blank faceplate, double height	Double	3-1/2 x 1-3/8	101
	FLDF-13	Two RJ-45 Female to Female Barrels, double height	Double	3-1/2 x 1-3/8	244
	FLDF-14	Cable Pass-Through Set - one top, one bottom	Double	3-1/2 x 1-3/8	426
	FLDF-15	One HDMI Female to Female Barrel	Single	3-1/2 x 5/8	284

GENERAL INFORMATION

- Faceplates are black

TECH ZONE	MODEL #	DESCRIPTION	SIMPLEX OUTLETS	OPEN DATA PORTS	CHARGING USB-A+C	PRICE
	ZONE-DATA	(2) Simplex receptacles, (2) Open data ports	2	2	-	375
	ZONE-USB-C	(2) Simplex receptacles, (1) Charging USB-A+C, (1) Open data port	2	1	1	449

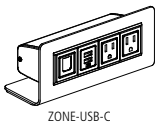

ZONE-USB-C



ZONE-DATA



ZONE-USB-C

GENERAL INFORMATION

- 72" long plug-in infeed cord
- Finish is black
- Includes a Voice/Data Adapter Kit to accept couplers and jacks when required



Appendix



This price book supercedes all previous versions.

Before placing your order, confirm you have all required information necessary. Lead times for orders begin after all required information is included and correct.

Delivery Information

We know lead times are important and sticking to them even more so. We work to maintain a 6-8 week lead time on all standard products in this book from receipt of a clean order. All orders are acknowledged with an approximate shipping date and will be invoiced with the price in effect at the date the purchase order is received. For current lead times, please review www.nucraft.com/resources/lead-times.

Shipping charges are prepaid (within the continental U.S.). Therefore, pricing is a delivered price based on normal ground transportation. If you have special instructions, need to ship by air, or are shipping to Alaska or Hawaii, contact Nucraft Customer Service. Nucraft can also help arrange to have products blanket wrapped for an additional charge. Contact the Nucraft Customer Service team or specify it on your purchase order.

Minimum Freight Charge: Any order below \$3,000 net will be assessed a \$500 net minimum freight charge (one per order).

Orders are subject to acquiring the materials required for manufacturing. Fulfillment can be affected by strikes, fires, embargoes and acts of government. These elements are beyond our control.

Nucraft offers a variety of services to accommodate a wide range of delivery requirements. Availability of these services is dependent on a number of factors and may not be offered with all shipments. Examples of delivery services that have additional fees include:

- Specific date
- Specific time of day, morning or afternoon
- Delivery to a warehouse before delivery to its final destination (unless product is picked up at the warehouse)

Contact the Nucraft Customer Service team for availability and pricing on these services.

Freight Terms

Shipping charges for Nucraft products are prepaid for standard delivery in the continental United States. Standard delivery is defined as follows: Product is delivered on a 53' trailer being pulled by a long-haul tractor (total length of 85'). Facility will receive delivery Monday through Friday between the hours of 8:00 AM and 4:00 PM. Facility has docks with levelers and a fork truck for unloading. Product will be loaded on load bars two levels high. Receiving facility is responsible to have personnel on hand to unload the truck upon arrival, drivers do not unload. Delivery sites or times that do not meet these criteria may be accommodated, but will incur a charge to cover additional shipping costs. Please **notify Nucraft a minimum of two weeks prior to shipment** to arrange special services and determine additional charges.

Storage

Nucraft has no storage facilities for finished product. If a customer cannot accept an order when it is ready for shipment, the customer must designate an alternative shipping address. If no address is provided, Nucraft may, at its discretion, transfer the product to storage. If product is transferred to an off-site storage facility, the customer may be charged for transportation to the facility and for any associated storage fees. Nucraft considers transfer of the product to a storage facility the equivalent of shipment, including invoicing and payment. Customers assume the risk of damage or loss during storage.

Transportation Times and Delays

Third party carriers that Nucraft contracts with will make reasonable efforts to accommodate requested delivery times and dates. Scheduled delivery appointments may, however, be delayed for a variety of reasons, including inclement weather, traffic, transportation equipment problems, and delays encountered at other delivery locations along the delivery route. Nucraft does not recommend scheduling activities that depend on the delivery appointment (for example, scheduling furniture installers to install furniture the day of the delivery appointment). Nucraft shall not be liable for any costs incurred as a result of a missed delivery appointment.

Shipment Damage Claims

Legal title to merchandise passes to the buyer upon acceptance by the carrier. Inspect all cartons upon delivery. Details of visible damage should be noted on the delivery receipt. Do not destroy packaging, transport to site, or install product if damage is found upon inspection. Inspection of products should be completed upon delivery to the receiver. If visible damage is apparent, a claim should be filed immediately with Nucraft Customer Service. If visible damage is not apparent, sign the delivery receipt "No visible damage." This will allow recourse for a concealed damage claim. Concealed damage claims must be filed within 15 days of receipt, **prior to transporting or installing any product.**

Do not destroy packing materials until shipment has been inspected. If damage is found, proceed to file a claim with Nucraft Customer Service.

Failure to make any claims against Nucraft within 15 days shall constitute acceptance of the merchandise and a waiver of any defects, errors or shortages discovered upon inspection.

Cancellations

Cancellations must be reviewed by our Customer Service team. Because we build your products to order, orders cannot be cancelled once processing has begun. Processing includes but is not limited to development of shop drawings and other engineering drawings. If cancellation is approved, a processing fee of 20-100% will be assessed based on the status of the order.

Change Order Policy

Nucraft will make every attempt to honor any reasonable change request to product provided that the request is received prior to start of production. Change orders will be accepted only if the request is made in writing and received in time to make the change. Nucraft reserves the right to increase our acknowledged price and ship date if necessary to make the requested changes. Please submit any change order request to our Customer Service team. Nucraft will assess charges to the customer as stipulated in the following:

- Standard Orders: Change orders received prior to production will be charged \$400 net to cover administrative costs.
- Special Orders: Change orders received prior to production will be charged \$400 net to cover administrative costs. There may be additional costs associated with engineering labor required for the change order.
- Change orders received after production must be evaluated by Nucraft. If approved, the charge will be \$400 net plus any restocking charges accumulated. There may be additional costs associated with engineering and/or manufacturing labor, as well as material costs, required for the change order.



Repair Authorization

Prior written approval is required for repairs of merchandise charged to Nucraft. Failure to do so will result in customer funded repairs.

Payment Terms

Deposits are required at the time of order due to the custom nature of our products. See information regarding Cancellations above.

Credit terms are available to qualified customers. Please contact AR@Nucraft.com to start the application process. Note that the credit application process requires a valid sales tax exemption or resale tax certificate, Form W-9, and three current trade references.

Credit Card Payments are accepted via web portal. Please contact AR@Nucraft.com for payment instructions. Note that a 2% convenience fee will be added for using this payment method and no early pay discounts are allowed on credit card payments.

Warranty

Nucraft Furniture is warranted to be free from defects in materials and workmanship for a period of ten years of single shift use. Limitations include:

- Mechanical Devices such as latches, casters, and other moving components are warranted for five years of the date of original delivery.
- Height adjustable components are warranted for two years of the date of original delivery.
- The following are warranted for one year of the date of original delivery:
 - Textiles
 - Electrical Components
 - Refrigeration Units
 - Custom Products not described in Nucraft's Catalogue

This warranty is applicable only if furniture is properly installed and maintained in an office environment. This warranty extends only to products manufactured and sold in North America and only to original purchasers acquiring new Nucraft product through authorized dealers or approved sellers.

During this warranty period, Nucraft's sole obligation is to repair or replace, at Nucraft's discretion, products which prove to be defective during the warranty period.

This warranty does not cover:

- Damage caused by a carrier.
- Damage from user modification, misuse, abuse, accident, or negligence.
- Customer's Own Material (COM) specified by the customer that is not a standard product offering.
- Color, grain, or texture of wood and other covering material.

Nucraft extends no other warranties, expressed or implied, including warranty of merchantability or fitness for a particular purpose. Nucraft shall not be liable for loss of time, inconvenience, commercial loss, incidental or consequential damages.

Environmental Statement

Nucraft is committed to supporting responsible environmental policies and practices in all that we do. We strive for sustainability, weighing our business decisions against the costs to the ecological, social and economic systems they affect.

Our products are manufactured to meet the credit requirements of the U.S. Green Building Council's LEED rating systems in one or more of the following categories:

- Recycled Content
- Certified Wood
- Low-Emitting Materials

Computer Aided Planning

Nucraft products and pricing are available via CET and 2020 Worksheet, an AutoCAD®-based space planning tool.

2020 Worksheet is an integrated software system developed specifically for interior designers and facility planners to enhance workplace performance. This modern suite of applications works together seamlessly, in concert. Navigate catalogs, select products, design in plan view and 3D, assign options, create worksheets and build a project where you want, when you want. Take your pick. It's dynamic and interactive. Design projects are a work in progress. And now you can perform any of the many discrete tasks that go into a project any time, any place.

Product symbols (Revit, 2D and 3D) are available on the Nucraft website at www.nucraft.com/resources/designer-tools/product-symbols.

iSpec®

Nucraft offers a free online product configuration and specification service that saves you time and allows you to be creative while leaving the nuts and bolts to someone else. No specific software is required, nor is there any learning curve. This service applies to all Nucraft products. For additional information, visit www.nucraft.com/resources/designer-tools/ispec.



Surface Materials Palette

We crafted our materials palette using the same demanding standards that distinguish our furniture. Thoughtful design and attention to every detail elevate your possibilities.

Anchored by Nucraft veneers, unrivaled for clarity, quality, and depth of finish, our collection of surface materials comprises a sophisticated set of balanced elements that supports your design vision.

Some elements have their roots in Nucraft's rich heritage. Others are new materials and reflect current trends and taste. Together, they ensure that you're ready for today and positioned well for the future. Beautifully.

Custom Finishes

Nucraft specializes in expert custom finish matching. For a nominal upcharge we can provide custom finishes, and we are frequently asked to match the finishes of other furniture manufacturers. For finishes that appear unusual to match or for customers directly requesting a sample, a finish sample will be sent for approval prior to entering the order.

Custom finishes requiring colored varnishes to create a painted look can only be applied to Maple veneer and require one extra week in addition to the standard lead time. Nucraft's standard black finish (G82) can be applied to all Nucraft standard veneers. Walnut is the standard black veneer. Other species must be specified when ordering.

Clear coat on a special veneer requires an approved sample.

Custom finishes carry a 10% upcharge per item, per finish, capped at \$2,200 List.

Custom finish upcharges are not applied to any item that is not wood. Example: casters, ganging connectors, power options..

Treatments

Note: Default veneer sheen will vary per finish and product. Default finish is bolded on pages vi-vii. If no direction is provided on incoming orders, default sheen will be selected. In addition, default veneer cut is noted in the price list. If no direction is provided on incoming orders, default cut will be selected.

Gloss: Gloss is a durable finish that tends to nicely mask normal wear and leaves wood grain visible to the eye. It achieves a medium gloss open pore appearance (40 – 50 sheen range). Finish numbers preceded by the letter "G" indicate a Gloss finish.

Matte: Like Gloss, Matte is durable, tends to nicely mask normal wear and leaves wood grain visible to the eye. It achieves a low luster, open pore appearance (10 – 20 sheen range). Finish numbers preceded by the letter "M" indicate a Matte finish.

Since each veneer type responds differently to both types of treatment, all will have a distinctive look and feel when finished. For example, a Walnut veneer with a Gloss treatment will remain much more textured than a Cherry veneer with the same treatment.

About the Wood

All Nucraft veneers are carefully selected for uniformity of color and grain. Still, wood is a natural substance and minor variations may occur due to its own uniqueness. Because of this, the furniture you receive may not be an exact match to our samples.

Nucraft takes great pride in our finish color consistency. However, wood is a natural product that will have color variation within a single piece of furniture, as well as from one piece to the next. Other factors also affect color over time, such as exposure to light (both intensity and duration). For example, lighter finishes cause more variation in colors over time.

In cases where a returning customer wants a precise match with existing furniture, we recommend sending a sample of the existing furniture finish. Please contact Nucraft Customer Service to determine an appropriate sample. This will ensure a finish match between old and new orders. This type of order is considered a control sample. There will be a 10% upcharge on an order of this type. Due to natural aging of veneers, natural finishes may vary.

Care and Maintenance of Wood Finishes

Our finish material is a crystal clear, urethane acrylic blend. This type of finish may be repaired in the field by a qualified refinisher.

Nucraft recommends using a damp cloth to clean your fine wood furniture. Always wipe with the grain of the wood. Should your wood furniture require a more thorough cleaning, we recommend using a mild cleaner such as Joy dish soap or Murphy's oil soap, thoroughly diluted in water (one part soap to thirty parts water). Water will not damage Nucraft's finish, but it may leave surface spots when it dries. To avoid this, dry the surface with a soft cloth after it is cleaned. Marks that cannot be removed with the cleaning methods above may be able to be removed using naphtha, a mild degreasing solvent.

Caution: while the use of polishes that contain wax, petroleum solvents or silicones may immediately enhance the "shine" of a product, it may also eventually remove the fine original finish applied in our factory. Silicone on the surface of wood may also make it very difficult to respray or refinish.

All Nucraft furniture is inspected and polished before it leaves our factory. In some instances, the packing materials may imprint on the factory polish. Cleaning and polishing the furniture once it is unpacked will normally restore the furniture to its original beauty.

In some cases, the rubber support feet used on the bottom of common office equipment (teleconferencing phones, laptops, microphones, copiers, etc.) can create unsightly marks in the surface of wood tops, due to oxidation of the lacquer finish. We suggest these machines be placed on a protective type of padding, such as felt.

Wood will fade as a result of exposure to UV light. This is particularly prevalent with light finishes. If color changes due to fading are a concern for your application, the impact can be minimized by selecting medium to dark stains for your wood surfaces. Our top coat includes a UV inhibitor which makes the finishes less prone to fading.



Laminates

Selected Formica®, Nevamar®, and Wilsonart® laminates are available on Training Tables, Conference Tables, Conference Room Furniture and select Occasional Tables. For standard laminate and wood pricing, refer to individual item pricing columns. It is important to note that wood grain laminates are unable to be grain matched over multi-piece table top applications.

Non-Standard Laminates and Linoleums

To order a color other than those on our list (see pages vi-vii), refer to Nevamar or Formica standard grade, matte texture laminate offerings and Forbo Furniture Linoleums (excluding manufacturers' non-standard matte offering).

Nucraft can support other laminate and linoleum options beyond what can be found as standard options on pages vi-viii. For pricing, please send a request to quotes@nucraft.com.

Care and Maintenance of Laminate and Novawrap

Laminate and Novawrap surfaces may be cleaned with a damp cloth and ordinary soap or non-abrasive household liquid detergent. Dry the surface with a clean cloth or soft paper towel to prevent streaks from appearing.

Care and Maintenance of Metal

Metal surfaces can be wiped with a damp cloth and rubbed dry. A mild non-abrasive household liquid detergent can be used if necessary. Regular maintenance of metal components, including tightening of fasteners and light lubrication of moving parts, will extend the life of your furniture.

Satin Etched Glass

Glass color may vary slightly on multi-piece conference table tops over 180" x 60" when satin etched glass is specified due to the iron content and etching process of the glass.

Care and Maintenance of Glass

Clear or frosted glass may be cleaned with commercial glass cleaner. Be sure to use a lint-free cloth if cleaning the frosted side of the glass.

Stone and Solid Surface Material

Despite its reputation for durability, natural stone can easily be broken during handling and/or installation if proper techniques are not followed. In addition, Nucraft is not responsible for the installation of natural stone or solid surface materials on its products. Therefore, installers specifically trained in the installation of these materials must be utilized to ensure a quality installation. Nucraft shall not be liable for any damages incurred during the handling and/or installation of natural stone or solid surface materials on its products.

Care and Maintenance of Granite

Granite surfaces may be cleaned with a damp cloth and ordinary soap or non-abrasive household liquid detergent. Dry the surface with a clean cloth or soft paper towel to prevent streaks from appearing.

Care and Maintenance of Leather

Genuine leather requires very little care. Nucraft recommends that leather be dusted regularly. If a more thorough cleaning is needed, use lukewarm water and a mild, non-abrasive soap. Generate some lather and lightly rub the surface with cheesecloth. Rinse off any soap film with clean water and towel dry. The leather may dry dull. To restore the leather to a normal gloss, rub it with a clean towel. Never use furniture polish, oil, varnish or ammonia. Saddle soap may be used to prevent the leather from becoming brittle or cracked and to maintain the original supple finish.

Touch Up Finish Kits

Model #	Description	Price
KIT-M	Metal Kit	85
KIT-P	Paint Kit	85
KIT-S	Stain Kit	85

REQUIRED INFORMATION:

(ORDER CANNOT BE ENTERED WITHOUT THIS INFORMATION)

- Kit model number
- Quantity of kits
- Specify finish (See pages vi-vii)

General Information:

- Touch-up kits must be ordered on a purchase order separate from Nucraft product due to Hazmat shipping

Retrofit & Replacements

If needing a partial placement or retrofit solution, please reach out to our quote team. Grain/color matched in a set.



VENEER

STANDARD

Default veneer sheen will vary per finish and were determined by a team of experts who reviewed the colorways to determine if gloss or matte best highlighted the natural characteristics of the species of wood and the color of the stain. Default finish is bolded. If no direction is provided, default sheen will be selected.

	Matte	Gloss
Rift Cut Oak		
Carbon	M03	G03
Flat Cut Oak		
Artisan	M68	G68
Coco	M67	G67
Dove	M66	G66
Dune	M05	G05
Midnight	M69	G69
Portobello	M7413	G7413
Winter	M70	G70
Flaky Oak		
Sahara	M61	G61
Cherry		
Auburn	M93	G93
Cognac	M21	G21
Walnut		
Marron	M35	G35
Mocha	M33	G33
Onyx	M82	G82
Otter	M31	G31
Zinc	M30	G30
Maple		
Natural Maple	M60	G60
Linea		
Euro Birch Linea	M09	G09
Oak Linea	M08	G08
Silver Birch Linea	M10	G10
Walnut Linea	M27	G27
Paldao		
Canyon	M77	G77
Paldao	M76	G76
Thicket	M75	G75

LAMINATE

Solid Laminates

Formica Brite White	459-58
Formica Dover White	7197-58
Formica Folkstone	927-58
Formica Graphite	837-58
Formica Graystone	464-58
Formica Pearl	934-58

Patterned Laminates

Nevamar Calm Distinction	VA6001T
Nevamar Cool Chic	VA7002T
Nevamar Easy Elegance	VA5002T
Nevamar Serene Stardom	VA5001T
Wilsonart Sheer Mesh	4876-38
Wilsonart Grey Mesh	4877-38
Wilsonart Pewter Mesh	4878-38

GLASS*

	Satin	Gloss
Satin or Gloss Glass		
Black	BS	-
Clove	VS	VG
Meringue	MS	MG
Moonlight	MLS	MLG
Storm	STS	STG
Quill	QS	QG
White	WS	WG

*Available on Power Matrix only.

METAL

Powder Coat

Aged Bronze	A8010
Black	A44
Burnished	A8009
Cloud	A8004
Foil	A8006
Galaxy	A8007
Moonlight	A87
Satin Bronze	A8011
Shadow	A8005
Storm	A8012

Metal

Clear Anodized	CA
Polished Chrome	(upcharge applies) PC