

FLEET™

Planning Guide + Price List

QUICK LINKS

[PLANNING GUIDE](#)

[FLEET PRICING](#)

[POWER AND DATA OPTIONS](#)

[GENERAL INFORMATION](#)

[FINISH INFORMATION](#)

[SURFACE MATERIALS](#)



TABLE OF CONTENTS

Click the shortcuts below to jump to each section.

General Information	ii-iii
Finish Information	iv-v
Surface Materials	vi-vii
Statement of Line	3
Planning Guide	4-12
C-Leg Tables	12-15
T-Leg Tables	16-21
Connecting Tops	22
Accessories	23
Power and Data Options	24-26

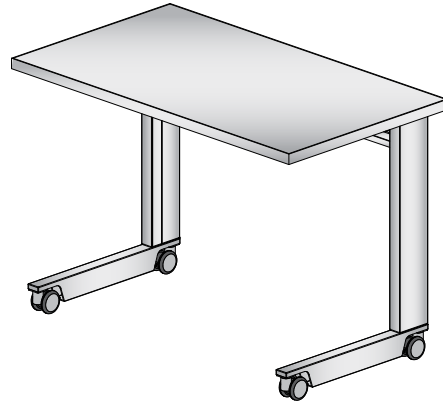



STATEMENT OF LINE

STATIONARY TABLES

Pages 12-13, 16-17, 20

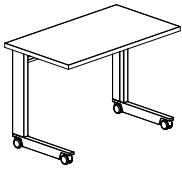

Rectangle

NESTING TABLES

Pages 14-15, 18-19, 21

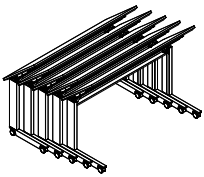

C-Leg

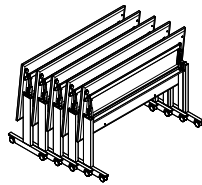

T-Leg

CONNECTING TOPS

Page 22





LEG DESIGN STYLES AND MODESTY PANEL

LEGS

- Two design styles:
 - C-Leg
 - T-Leg
 - Edge-Mount: Allows users to be seated along the long sides of the table and provides maximum leg space
 - Inset-Mount: Allows users to sit around all four sides of a table (offered only on larger table sizes). Legs are inset 13-1/2" from the table edge.
- Tables are standard with four locking casters
- Optional glides feature 1-1/4" of vertical adjustment
- Casters and glides are the same price and can be retrofitted in the field
- The vertical section of each leg includes a wire management channel along the inside surface. A removable cap hides cables running from the floor.

C-Leg

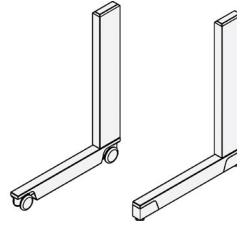

Casters

Glides

T-Leg

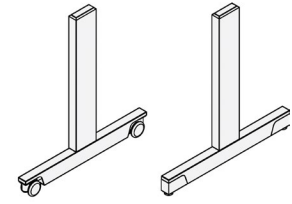

Casters

Glides

Leg Placement

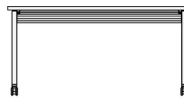

C-Leg



T-Leg (Edge-Mount)

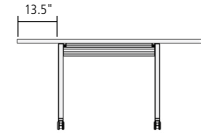

T-Leg (Inset-Mount)

Wire Management Channel



MODESTY PANEL

- The modesty panel is hinged, allowing it to swivel when the top is flipped up (on Nesting tables).
- The modesty panel is inset 1-1/2" from each end of the table, flush with the outer edge of the leg, creating a minimal visual gap between modesty panels in ganged applications.
- Two material options:
 - Wood
 - Metal - when powder coated legs are specified, the metal modesty panel will match the finish of the legs; when High Polish legs are specified, the metal modesty panel will be Clear Anodized.

With Modesty Panel

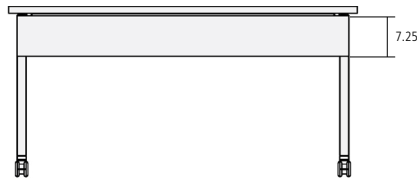

Without Modesty Panel

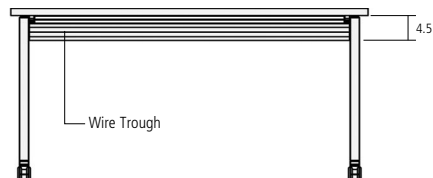



NESTING AND GANGING CONNECTOR

NESTING

- Provides one-handed operation to flip the table top upward for dense storage when tables are not in use.
- Top rotates upward with pneumatic assistance for enhanced ergonomics.
- Available on both C-Leg and T-Leg tables.
- Nesting tables feature an offset nest; see illustrations to determine the dimensions of the tables while nested.

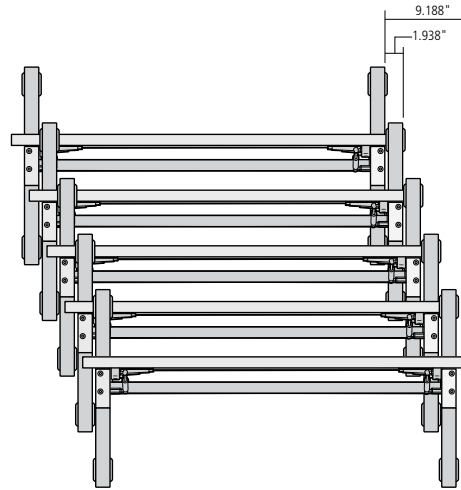

Offset nesting dimensions are the same for both C-Leg and T-Leg tables. (T-Leg Shown)

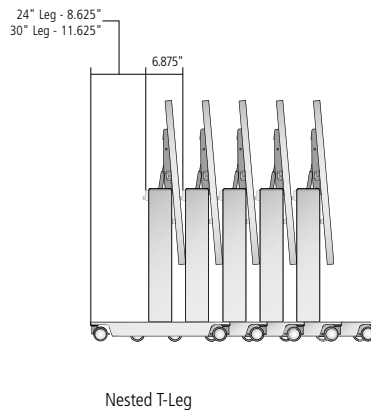
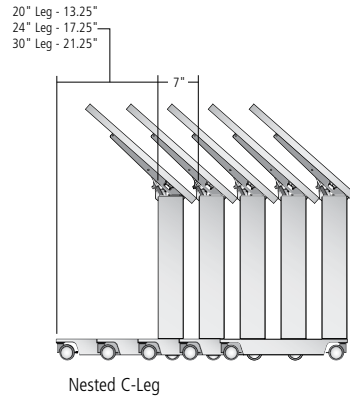

GANGING CONNECTOR (OPTIONAL)

- Optional on all tables
- Allows ganging end-to-end, front-to-front and front-to-end.
- All tables ship with the necessary threaded inserts in the underside of the table to accept the ganging mechanism. This allows the ganging mechanism to be added to the table in the field.

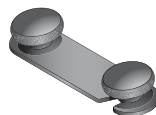



TECHNOLOGY ACCOMMODATION

WIRE MANAGEMENT CHANNEL

The vertical section of each leg includes a wire management channel along the inside surface. A removable cap hides cables running from the floor.

WIRE TROUGH

This cross rail between the legs can provide the means of supplying power to the table top power options listed on the next page or, for those customers who do not want connectivity to occur on the table top, can provide a location for making connections beneath the table top. There are two power options for this location:

Plug Strip

- Inexpensive, flexible means of providing power outlets

Two-Circuit Modular Power System

- 4-wire, 2-circuit modular system (20 amps)
- Transfers power between adjacent tables from a single point of entry
- Hardwired or direct plug infeed options. Power infeeds must be ordered separately.
- All components, except the direct plug infeed, are UL and cULus listed and meet NEC requirements; the direct plug infeed is not UL listed but does meet NEC standards.
- Each table ships with two duplex receptacles, as well as one jumper to connect to an adjacent table. Power infeeds must be ordered separately.

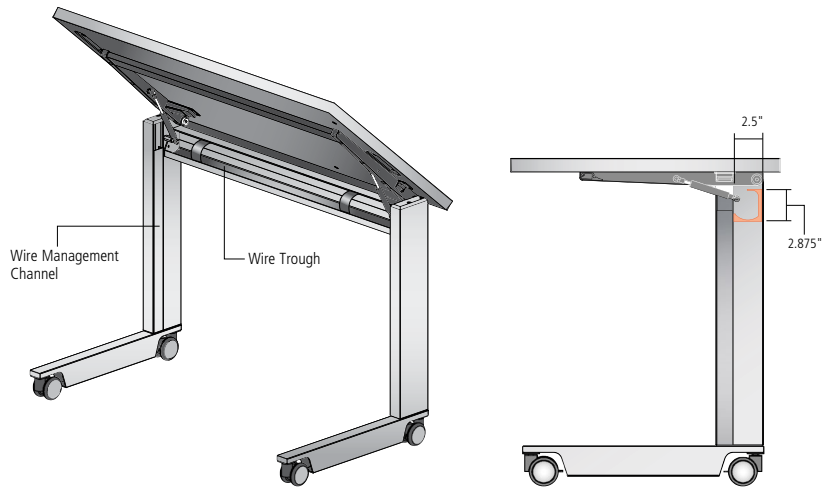

Plug Strip

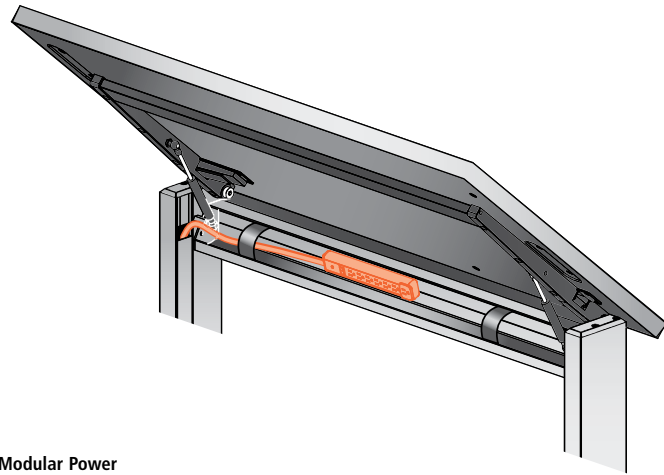

Modular Power

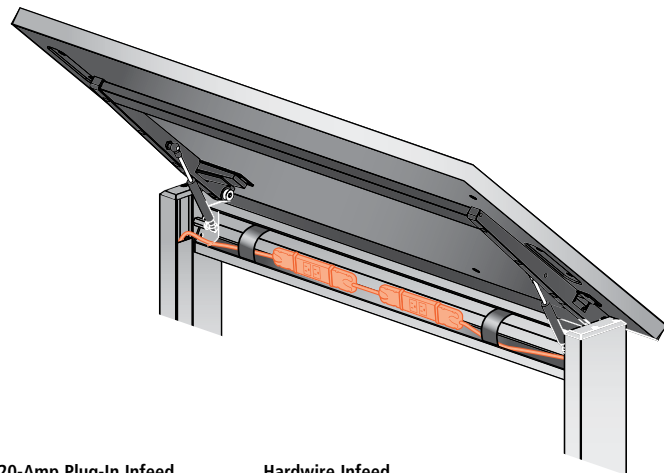

20-Amp Plug-In Infeed

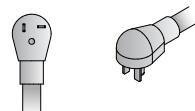

Hardwire Infeed





TABLE TOP POWER OPTIONS

For easy access to power & data connectivity, the power options available here include:

Power Matrix Compact

- Single door design
- Wood, glass and metal lids
- 5.375" x 6" cutout
- Two simplex outlets
- Three AV faceplates. Standard configuration includes two blank faceplates and one faceplate with two RJ-45 (data) connectors.

Power Matrix Compact

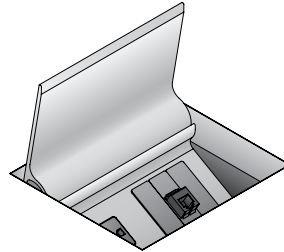

Grommet

- 2" Removable metal cap
- Mounted flush to the table top

Grommet

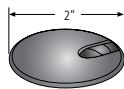

Tech Node

- Clear Anodized Aluminum
- Fluid one touch accessibility
- Overall dimensions - 4-7/16" x 8-5/16"
- Power: - 2 simplex receptacles
 - 12' 15-Amp plug-in power infeed (3' cord when specified with two-circuit modular power system)
 - UL Listed
- Voice/Data: Up to two mounting locations (includes adaptor kits)
- Voice/Data Adapter Kit p/n BE01421 to accept couplers & jacks
- Optional powered USB-A+C

Tech Node

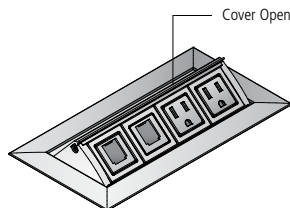

Tech Node - Open Front View

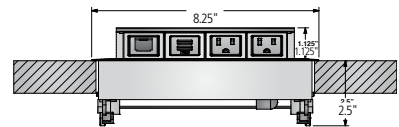

Tech Node - Open Side View

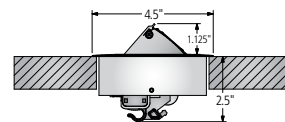

All electrical components are UL listed.

Voice/Data Planning

Two (2) simplex voice/data cutouts accept customer supplied, field-installed snap-in connectors. Nucraft recommends consulting an audio/visual (AV) integrator for assistance with voice/data planning.

Voice/Data Product Manufacturers

Manufacturer	Phone Number	Web Site
AMP	1-800-522-6752	www.tycoelectronics.com
Avaya	1-866-462-8292	www.avaya.com
Leviton	1-800-722-2082	www.leviton.com
Panduit	1-800-777-3300	www.panduit.com
Siemon	1-860-945-4200	www.siemon.com



TABLE TOP POWER OPTION: POWER MATRIX

Power Matrix is filled with a broad array of high performance features and refined aesthetic elements.

POWER

Power Matrix features two simplex receptacles for power connectivity. An optional USB-A+C charger can also be specified in place of one of the simplex receptacles when desired. Corded or hardwired infeed options add flexibility.

DATA/AV FACEPLATES

Power Matrix accommodates Extron Architectural Adaptor Plates (AAPs) for unparalleled flexibility in data and AV connectivity.

DESIGN

Power Matrix units feature a clear anodized aluminum body and a bezel-free flush mount design on wood tables for an elegant appearance. Laminate table tops include a bezel, available in powder coat, polished chrome or clear anodized finish options.

PERFORMANCE

Friction hinges ensure smooth travel through the door's range of motion and can hold the door in any position. Hidden door stops maintain the minimalist aesthetic.

DOORS

Power Matrix is offered in multiple door material options, including metal, glass and grain-matched wood cut from the same table top.

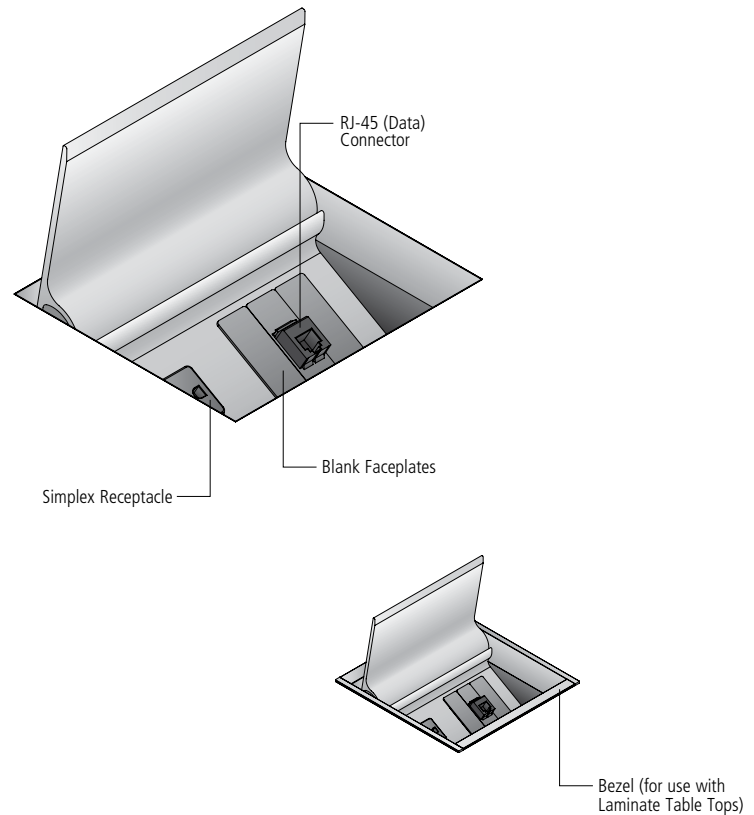



TABLE TOP POWER OPTION: POWER MATRIX

STANDARD CONFIGURATION

Power Matrix is offered with a pre-determined quantity of simplex outlets and AV faceplates. An optional 2 amp USB-A+C charger (1 amp per port) replaces one of the simplex outlets.

Compact

- Single door design
- 5.375" x 6" cutout
- Two simplex outlets
- Three AV faceplates. Standard configuration includes two blank faceplates and one faceplate with two RJ-45 (data) connectors.
- (1) 12' plug-in infeed cord

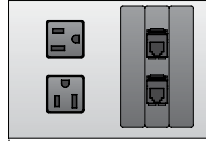

DIMENSIONS

The compact Power Matrix unit includes a low-profile pan beneath the work surface to conceal the unit.

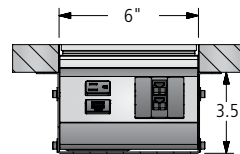
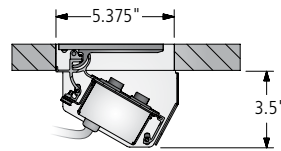

FIELD-WIRED

Some local electrical codes may require field-wiring during installation. In such instances, a Field-Wired option may be specified. In this configuration, each Power Matrix unit will be supplied with a 6' conduit with hot, ground and neutral wires.

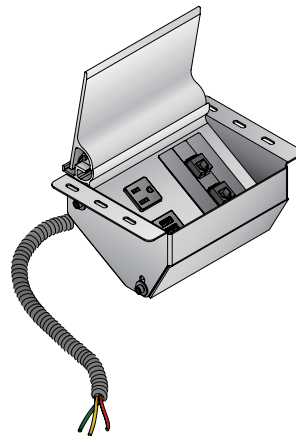



POWER LOCATION OPTIONS

Grommet, Tech Node and Power Matrix Locations

Rectangle

Grommet and Tech Node - C-Leg Tables

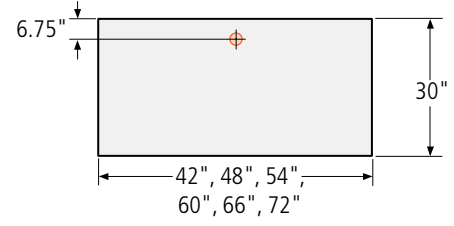
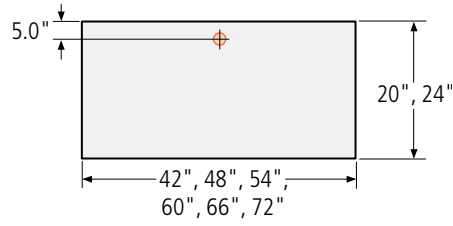

Grommet and Tech Node - Edge-Mount T-Leg Tables

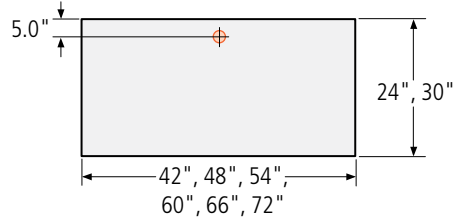

Grommet and Tech Node - Inset-Mount T-Leg Tables

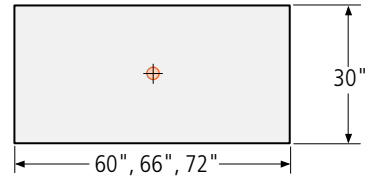

Power Matrix - C-Leg Tables

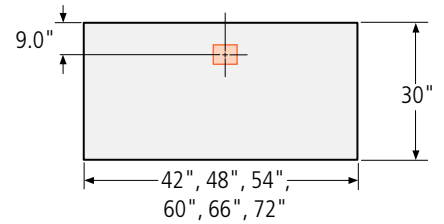
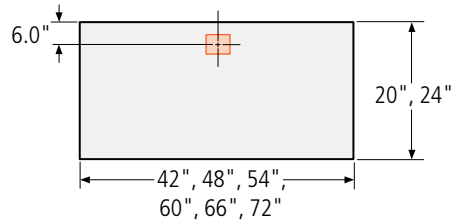

Power Matrix - T-Leg Tables (Not available on 24"-deep or Inset T-Leg Nesting Tables)

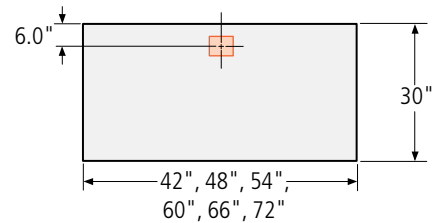



FREESTANDING POWER OPTION: TECH ZONE

TECH ZONE

Simple, easy to use and portable, this freestanding table top power option allows you to easily charge all of your devices.

Available in two configurations with a variety of power and data connectivity options. Includes a 72"-long plug-in infeed cord.

ZONE-USB-C

Includes two simplex receptacles, one data port and one charging USB-A+C charging port

ZONE-DATA

Includes two simplex receptacles and two open data ports

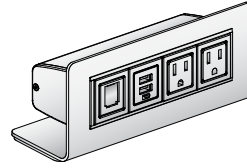

Tech Zone - Side View

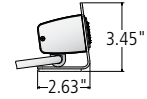

ZONE-USB-C

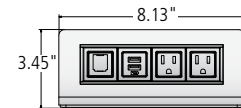

ZONE-DATA





C-LEG / STATIONARY TABLES

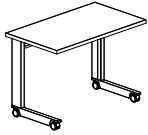

C-LEG STATIONARY TABLE

TOP SURFACE MATERIAL KEY

- 3MP Laminate Top with 2mm ABS Edge
- SQP Laminate Top with Square Wood Edge
- SQ Veneer Top with Square Wood Edge

C-LEG // STATIONARY TABLE

MODEL #	DEPTH	WIDTH	-3MP	-SQP	-SQ
WITHOUT MODESTY PANEL					
FLR-2042-CS	20	42	2,067	2,314	2,524
FLR-2048-CS	20	48	2,131	2,398	2,619
FLR-2054-CS	20	54	2,197	2,479	2,717
FLR-2060-CS	20	60	2,260	2,561	2,811
FLR-2066-CS	20	66	2,325	2,643	2,908
FLR-2072-CS	20	72	2,390	2,724	3,005
FLR-2442-CS	24	42	2,157	2,431	2,658
FLR-2448-CS	24	48	2,235	2,528	2,772
FLR-2454-CS	24	54	2,310	2,625	2,890
FLR-2460-CS	24	60	2,390	2,724	3,005
FLR-2466-CS	24	66	2,467	2,823	3,120
FLR-2472-CS	24	72	2,544	2,921	3,236
FLR-3042-CS	30	42	2,292	2,604	2,859
FLR-3048-CS	30	48	2,390	2,724	3,005
FLR-3054-CS	30	54	2,486	2,848	3,150
FLR-3060-CS	30	60	2,584	2,970	3,294
FLR-3066-CS	30	66	2,682	3,092	3,438
FLR-3072-CS	30	72	2,774	3,217	3,580

OPTIONS	CODE	PRICE	NOTES
Metal Modesty Panel Options:			
42" Long	-MM42	\$482	
48" Long	-MM48	\$506	
54" Long	-MM54	\$527	
60" Long	-MM60	\$553	
66" Long	-MM66	\$577	
72" Long	-MM72	\$603	
Wood Modesty Panel Options:			
42" Long	-WM42	\$624	
48" Long	-WM48	\$660	
54" Long	-WM54	\$689	
60" Long	-WM60	\$869	
66" Long	-WM66	\$906	
72" Long	-WM72	\$952	
Glides	Add -GB	No Charge	
Ganging Connectors	Add -GC	Add \$249 per table	- Ganging Connectors are for end-to-end, front-to-front and front-to-end connections
High Polish Leg Finish	Add -HPF	Add \$415 per table	
Wire Trough Power and Data Options			
Modular Power System	Add -MOD	Add \$462 per table	- Includes two duplex receptacles per table and one jumper to connect to adjacent table - Power infeed must be specified separately (see page 24)
Plug Strip	Add -PLUG	Add \$166 per table	
Table Top Power and Data Options:			See pages 24-26

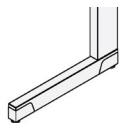

Glides
-GB

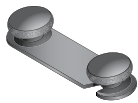

Ganging Connector
-GC

EDGE PROFILES



ABS EDGE
-3MP



SQUARE EDGE
-SQP or -SQ



C-LEG / STATIONARY TABLES

GENERAL INFORMATION

- Note: Due to the modular nature of these tables, exact grain matching between tables is not possible
- Overall table height 29-1/2"
- Tops are 1-1/8" thick
- Metal modesty panel finish color will match the color of the legs if powder coated, or will be Clear Anodized if -HPF leg finish is selected
- Tables ship standard with four locking casters
- Caster color will default based on leg finish (High Polish Finish, Cloud, Burnished, and Foil legs have Smoke casters; Shadow and Galaxy leg have Black casters)

REQUIRED INFORMATION (ORDER CANNOT BE ENTERED WITHOUT THIS INFORMATION)

See appendix pages vi-vii for surface material options.

Laminate Top with ABS Edge (-3MP)

- Choose Laminate
- Choose ABS Color
- Choose Metal Finish. Add \$415 per table for HPF option.

Laminate Top with Square Wood Edge (-SQP)

- Choose Laminate
- Choose Wood Edge Species & Finish
- Choose Metal Finish. Add \$415 per table for HPF option.

Veneer Top with Square Wood Edge (-SQ)

- Choose Veneer Finish
- Choose Metal Finish. Add \$415 per table for HPF option.



C-LEG / NESTING TABLES

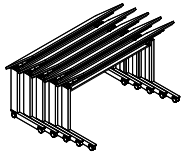

C-LEG NESTING TABLES

TOP SURFACE MATERIAL KEY

- 3MP Laminate Top with 2mm ABS Edge
- SQP Laminate Top with Square Wood Edge
- SQ Veneer Top with Square Wood Edge

C-LEG // NESTING TABLE

MODEL #	DEPTH	WIDTH	-3MP	-SQP	-SQ
WITHOUT MODESTY PANEL					
FLR-2042-CN	20	42	2,877	3,128	3,335
FLR-2048-CN	20	48	2,942	3,209	3,429
FLR-2054-CN	20	54	3,007	3,291	3,528
FLR-2060-CN	20	60	3,072	3,371	3,622
FLR-2066-CN	20	66	3,136	3,454	3,721
FLR-2072-CN	20	72	3,201	3,535	3,816
FLR-2442-CN	24	42	2,969	3,240	3,469
FLR-2448-CN	24	48	3,046	3,340	3,585
FLR-2454-CN	24	54	3,123	3,438	3,700
FLR-2460-CN	24	60	3,201	3,535	3,816
FLR-2466-CN	24	66	3,279	3,635	3,931
FLR-2472-CN	24	72	3,358	3,733	4,047
FLR-3042-CN	30	42	3,105	3,413	3,673
FLR-3048-CN	30	48	3,201	3,535	3,816
FLR-3054-CN	30	54	3,296	3,658	3,960
FLR-3060-CN	30	60	3,396	3,784	4,105
FLR-3066-CN	30	66	3,492	3,905	4,248
FLR-3072-CN	30	72	3,587	4,028	4,393

OPTIONS	CODE	PRICE	NOTES
Metal Modesty Panel Options:			
42" Long	-MM42	\$482	
48" Long	-MM48	\$506	
54" Long	-MM54	\$527	
60" Long	-MM60	\$553	
66" Long	-MM66	\$577	
72" Long	-MM72	\$603	
Wood Modesty Panel Options:			
42" Long	-WM42	\$624	
48" Long	-WM48	\$660	
54" Long	-WM54	\$689	
60" Long	-WM60	\$869	
66" Long	-WM66	\$906	
72" Long	-WM72	\$952	
Glides	Add -GB	No Charge	
Ganging Connectors	Add -GC	Add \$249 per table	- Ganging Connectors are for end-to-end, front-to-front and front-to-end connections
High Polish Leg Finish	Add -HPF	Add \$415 per table	
Wire Trough Power and Data Options			
Modular Power System	Add -MOD	Add \$462 per table	- Includes two duplex receptacles per table and one jumper to connect to adjacent table - Power infeed must be specified separately (see page 24)
Plug Strip	Add -PLUG	Add \$166 per table	
Table Top Power and Data Options:			See pages 24-26

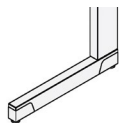

Glides
-GB

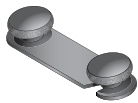

Ganging Connector
-GC

EDGE PROFILES



ABS EDGE
-3MP



SQUARE EDGE
-SQP or -SQ



C-LEG / NESTING TABLES

GENERAL INFORMATION

- Note: Due to the modular nature of these tables, exact grain matching between tables is not possible
- Overall table height 29-1/2"
- Tops are 1-1/8" thick
- Metal modesty panel finish color will match the color of the legs if powder coated, or will be Clear Anodized if -HPF leg finish is selected
- Tables ship standard with four locking casters
- Caster color will default based on leg finish (High Polish Finish, Cloud, Burnished, and Foil legs have Smoke casters; Shadow and Galaxy leg have Black casters)

REQUIRED INFORMATION (ORDER CANNOT BE ENTERED WITHOUT THIS INFORMATION)

See appendix pages vi-vii for surface material options.

Laminate Top with ABS Edge (-3MP)

- Choose Laminate
- Choose ABS Color
- Choose Metal Finish. Add \$415 per table for HPF option.

Laminate Top with Square Wood Edge (-SQP)

- Choose Laminate
- Choose Wood Edge Species & Finish
- Choose Metal Finish. Add \$415 per table for HPF option.

Veneer Top with Square Wood Edge (-SQ)

- Choose Veneer Finish
- Choose Metal Finish. Add \$415 per table for HPF option.



T-LEG / EDGE-MOUNTED STATIONARY TABLES

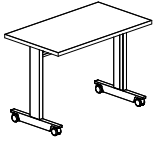

T-LEG EDGE-MOUNTED STATIONARY TABLE

TOP SURFACE MATERIAL KEY

- 3MP Laminate Top with 2mm ABS Edge
- SQP Laminate Top with Square Wood Edge
- SQ Veneer Top with Square Wood Edge

T-LEG // EDGE-MOUNTED STATIONARY TABLE

MODEL #	DEPTH	WIDTH	-3MP	-SQP	-SQ
WITHOUT MODESTY PANEL					
FLR-2442-TES	24	42	2,157	2,431	2,658
FLR-2448-TES	24	48	2,235	2,528	2,772
FLR-2454-TES	24	54	2,310	2,625	2,890
FLR-2460-TES	24	60	2,390	2,724	3,005
FLR-2466-TES	24	66	2,467	2,823	3,120
FLR-2472-TES	24	72	2,544	2,921	3,236
FLR-3042-TES	30	42	2,292	2,604	2,859
FLR-3048-TES	30	48	2,390	2,724	3,005
FLR-3054-TES	30	54	2,486	2,848	3,150
FLR-3060-TES	30	60	2,584	2,970	3,294
FLR-3066-TES	30	66	2,682	3,092	3,438
FLR-3072-TES	30	72	2,774	3,217	3,580

OPTIONS	CODE	PRICE	NOTES
Metal Modesty Panel Options:			
42" Long	-MM42	\$482	
48" Long	-MM48	\$506	
54" Long	-MM54	\$527	
60" Long	-MM60	\$553	
66" Long	-MM66	\$577	
72" Long	-MM72	\$603	
Wood Modesty Panel Options:			
42" Long	-WM42	\$624	
48" Long	-WM48	\$660	
54" Long	-WM54	\$689	
60" Long	-WM60	\$869	
66" Long	-WM66	\$906	
72" Long	-WM72	\$952	
Glides	Add -GB	No Charge	
Ganging Connectors	Add -GC	Add \$249 per table	- Ganging Connectors are for end-to-end, front-to-front and front-to-end connections
High Polish Leg Finish	Add -HPF	Add \$415 per table	
Wire Trough Power and Data Options			
Modular Power System	Add -MOD	Add \$462 per table	- Includes two duplex receptacles per table and one jumper to connect to adjacent table - Power infeed must be specified separately (see page 24)
Plug Strip	Add -PLUG	Add \$166 per table	
Table Top Power and Data Options:			See pages 24-26

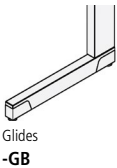

EDGE PROFILES



ABS EDGE
-3MP



SQUARE EDGE
-SQP or -SQ



T-LEG / EDGE-MOUNTED STATIONARY TABLES

GENERAL INFORMATION

- Note: Due to the modular nature of these tables, exact grain matching between tables is not possible
- Overall table height 29-1/2"
- Tops are 1-1/8" thick
- Metal modesty panel finish color will match the color of the legs if powder coated, or will be Clear Anodized if -HPF leg finish is selected
- Tables ship standard with four locking casters
- Caster color will default based on leg finish (High Polish Finish, Cloud, Burnished, and Foil legs have Smoke casters; Shadow and Galaxy leg have Black casters)
- Power Matrix and Modular Power not available on 24"-deep tables

REQUIRED INFORMATION (ORDER CANNOT BE ENTERED WITHOUT THIS INFORMATION)

See appendix pages vi-vii for surface material options.

Laminate Top with ABS Edge (-3MP)

- Choose Laminate
- Choose ABS Color
- Choose Metal Finish. Add \$415 per table for HPF option.

Laminate Top with Square Wood Edge (-SQP)

- Choose Laminate
- Choose Veneer Finish
- Choose Metal Finish. Add \$415 per table for HPF option.

Veneer Top with Square Wood Edge (-SQ)

- Choose Veneer Finish
- Choose Metal Finish. Add \$415 per table for HPF option.



T-LEG / EDGE-MOUNTED NESTING TABLES

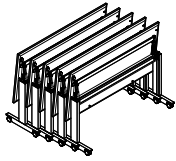

T-LEG EDGE-MOUNTED NESTING TABLES

TOP SURFACE MATERIAL KEY

- 3MP Laminate Top with 2mm ABS Edge
- SQP Laminate Top with Square Wood Edge
- SQ Veneer Top with Square Wood Edge

T-LEG // EDGE-MOUNTED NESTING TABLES

MODEL #	DEPTH	WIDTH	-3MP	-SQP	-SQ
WITHOUT MODESTY PANEL					
FLR-2442-TEN	24	42	2,969	3,240	3,469
FLR-2448-TEN	24	48	3,046	3,340	3,585
FLR-2454-TEN	24	54	3,123	3,438	3,700
FLR-2460-TEN	24	60	3,201	3,535	3,816
FLR-2466-TEN	24	66	3,279	3,635	3,931
FLR-2472-TEN	24	72	3,358	3,733	4,047
FLR-3042-TEN	30	42	3,105	3,413	3,673
FLR-3048-TEN	30	48	3,201	3,535	3,816
FLR-3054-TEN	30	54	3,296	3,658	3,960
FLR-3060-TEN	30	60	3,396	3,784	4,105
FLR-3066-TEN	30	66	3,492	3,905	4,248
FLR-3072-TEN	30	72	3,587	4,028	4,393

OPTIONS	CODE	PRICE	NOTES
Metal Modesty Panel Options:			
42" Long	-MM42	\$482	
48" Long	-MM48	\$506	
54" Long	-MM54	\$527	
60" Long	-MM60	\$553	
66" Long	-MM66	\$577	
72" Long	-MM72	\$603	
Wood Modesty Panel Options:			
42" Long	-WM42	\$624	
48" Long	-WM48	\$660	
54" Long	-WM54	\$689	
60" Long	-WM60	\$869	
66" Long	-WM66	\$906	
72" Long	-WM72	\$952	
Glides	Add -GB	No Charge	
Ganging Connectors	Add -GC	Add \$249 per table	- Ganging Connectors are for end-to-end, front-to-front and front-to-end connections
High Polish Leg Finish	Add -HPF	Add \$415 per table	
Wire Trough Power and Data Options			
Modular Power System	Add -MOD	Add \$462 per table	- Includes two duplex receptacles per table and one jumper to connect to adjacent table - Power infeed must be specified separately (see page 24)
Plug Strip	Add -PLUG	Add \$166 per table	
Table Top Power and Data Options:			See pages 24-26

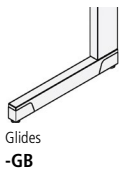

EDGE PROFILES



ABS EDGE
-3MP



SQUARE EDGE
-SQP or -SQ



T-LEG / EDGE-MOUNTED NESTING TABLES

GENERAL INFORMATION

- Note: Due to the modular nature of these tables, exact grain matching between tables is not possible
- Overall table height 29-1/2"
- Tops are 1-1/8" thick
- Metal modesty panel finish color will match the color of the legs if powder coated, or will be Clear Anodized if -HPF leg finish is selected
- Tables ship standard with four locking casters
- Caster color will default based on leg finish (High Polish Finish, Cloud, Burnished, and Foil legs have Smoke casters; Shadow and Galaxy legs have Black casters)
- Power Matrix and Modular Power not available on 24"-deep tables

REQUIRED INFORMATION (ORDER CANNOT BE ENTERED WITHOUT THIS INFORMATION)

See appendix pages vi-vii for surface material options.

Laminate Top with ABS Edge (-3MP)

- Choose Laminate
- Choose ABS Color
- Choose Metal Finish. Add \$415 per table for HPF option.

Laminate Top with Square Wood Edge (-SQP)

- Choose Laminate
- Choose Veneer Finish
- Choose Metal Finish. Add \$415 per table for HPF option.

Veneer Top with Square Wood Edge (-SQ)

- Choose Veneer Finish
- Choose Metal Finish. Add \$415 per table for HPF option.



T-LEG / INSET-MOUNTED STATIONARY TABLES

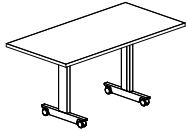

T-LEG INSET-MOUNTED STATIONARY TABLES

TOP SURFACE MATERIAL KEY

- 3MP Laminate Top with 2mm ABS Edge
- SQP Laminate Top with Square Wood Edge
- SQ Veneer Top with Square Wood Edge

T-LEG // INSET-MOUNTED STATIONARY TABLE

MODEL #	DEPTH	WIDTH	-3MP	-SQP	-SQ
WITHOUT MODESTY PANEL					
FLR-3060-TIS	30	60	2,584	2,970	3,294
FLR-3066-TIS	30	66	2,682	3,092	3,438
FLR-3072-TIS	30	72	2,774	3,217	3,580

OPTIONS	CODE	PRICE	NOTES
Metal Modesty Panel Options:			
60" Long	-MM60	\$553	
66" Long	-MM66	\$577	
72" Long	-MM72	\$603	
Wood Modesty Panel Options:			
60" Long	-WM60	\$869	
66" Long	-WM66	\$906	
72" Long	-WM72	\$952	
Glides	Add -GB	No Charge	
Ganging Connectors	Add -GC	Add \$249 per table	- Ganging Connectors are for end-to-end, front-to-front and front-to-end connections
High Polish Leg Finish	Add -HPF	Add \$415 per table	
Table Top Power and Data Options:			See pages 24-26

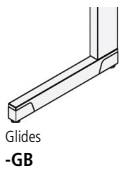

EDGE PROFILES



ABS EDGE
-3MP



SQUARE EDGE
-SQP or -SQ

GENERAL INFORMATION

- Note: Due to the modular nature of these tables, exact grain matching between tables is not possible
- Overall table height 29-1/2"
- Tops are 1-1/8" thick
- Metal modesty panel finish color will match the color of the legs if powder coated, or will be Clear Anodized if -HPF leg finish is selected
- Tables ship standard with four locking casters
- Caster color will default based on leg finish (High Polish Finish, Cloud, Burnished, and Foil legs have Smoke casters; Shadow and Galaxy legs have Black casters)
- Wire trough power options not available on inset-mounted T-Leg tables
- Power Matrix and Modular Power not available on Inset-Mounted T-Leg tables

REQUIRED INFORMATION (ORDER CANNOT BE ENTERED WITHOUT THIS INFORMATION)

See appendix pages vi-vii for surface material options.

Laminate Top with ABS Edge (-3MP)

- Choose Laminate
- Choose ABS Color
- Choose Metal Finish. Add \$415 per table for HPF option.

Laminate Top with Square Wood Edge (-SQP)

- Choose Laminate
- Choose Veneer Finish
- Choose Metal Finish. Add \$415 per table for HPF option.

Veneer Top with Square Wood Edge (-SQ)

- Choose Veneer Finish
- Choose Metal Finish. Add \$415 per table for HPF option.



T-LEG / INSET-MOUNTED NESTING TABLES

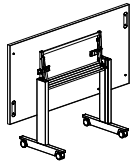

T-LEG INSET-MOUNTED NESTING TABLE

TOP SURFACE MATERIAL KEY

- 3MP Laminate Top with 2mm ABS Edge
- SQP Laminate Top with Square Wood Edge
- SQ Veneer Top with Square Wood Edge

T-LEG // INSET-MOUNTED NESTING TABLE

MODEL #	DEPTH	WIDTH	-3MP	-SQP	-SQ
WITHOUT MODESTY PANEL					
FLR-3060-TIN	30	60	3,396	3,784	4,105
FLR-3066-TIN	30	66	3,492	3,905	4,248
FLR-3072-TIN	30	72	3,587	4,028	4,393

OPTIONS	CODE	PRICE	NOTES
Metal Modesty Panel Options:			
60" Long	-MM60	\$553	
66" Long	-MM66	\$577	
72" Long	-MM72	\$603	
Wood Modesty Panel Options:			
60" Long	-WM60	\$869	
66" Long	-WM66	\$906	
72" Long	-WM72	\$952	
Glides	Add -GB	No Charge	
Ganging Connectors	Add -GC	Add \$249 per table	- Ganging Connectors are for end-to-end, front-to-front and front-to-end connections
High Polish Leg Finish	Add -HPF	Add \$415 per table	
Table Top Power and Data Options:			See pages 24-26

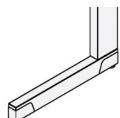

Glides
-GB

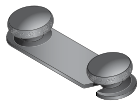

Ganging Connector
-GC

EDGE PROFILES



ABS EDGE
-3MP



SQUARE EDGE
-SQP or -SQ

GENERAL INFORMATION

- Note: Due to the modular nature of these tables, exact grain matching between tables is not possible
- Overall table height 29-1/2"
- Tops are 1-1/8" thick
- Metal modesty panel finish color will match the color of the legs if powder coated, or will be Clear Anodized if -HPF leg finish is selected
- Tables ship standard with four locking casters
- Caster color will default based on leg finish (High Polish Finish, Cloud, Burnished, and Foil legs have Smoke casters; Shadow and Galaxy legs have Black casters)
- Wire trough power options not available on inset-mounted T-Leg tables
- Power Matrix and Modular Power not available on Inset-Mounted T-Leg tables

REQUIRED INFORMATION (ORDER CANNOT BE ENTERED WITHOUT THIS INFORMATION)

See appendix pages vi-vii for surface material options.

Laminate Top with ABS Edge (-3MP)

- Choose Laminate
- Choose ABS Color
- Choose Metal Finish. Add \$415 per table for HPF option.

Laminate Top with Square Wood Edge (-SQP)

- Choose Laminate
- Choose Veneer Finish
- Choose Metal Finish. Add \$415 per table for HPF option.

Veneer Top with Square Wood Edge (-SQ)

- Choose Veneer Finish
- Choose Metal Finish. Add \$415 per table for HPF option.



CONNECTING TOPS



30-DEGREE

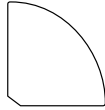

90-DEGREE

TOP SURFACE MATERIAL KEY

- 3MP Laminate Top with ABS Edge
- SQP Laminate Top with Square Wood Edge
- SQ Veneer Top with Square Wood Edge

30-DEGREE CONNECTING TOP

MODEL #	DEPTH	-3MP	-SQP	-SQ
FLC-2030	20	1,235	1,497	1,719
FLC-2430	24	1,368	1,668	1,916
FLC-3030	30	1,616	1,981	2,286

90-DEGREE CONNECTING TOP

MODEL #	DEPTH	-3MP	-SQP	-SQ
FLC-2090	20	1,235	1,497	1,719
FLC-2490	24	1,368	1,668	1,916
FLC-3090	30	1,616	1,981	2,286

OPTIONS

OPTIONS	CODE	PRICE	NOTES
Modular Power System	Add -MODC	Add \$364 per table	- Includes one jumper to connect to adjacent table

EDGE PROFILES



ABS EDGE
-3MP



SQUARE EDGE
-SQP or -SQ

GENERAL INFORMATION

- Note: Due to the modular nature of these tables, exact grain matching between tables is not possible
- Tops are 1-1/8" thick
- Connecting Tops include two ganging connectors. Tables to which Connecting Tops will be connected must also have ganging connectors.
- No table top power and data options available on connecting tops

REQUIRED INFORMATION (ORDER CANNOT BE ENTERED WITHOUT THIS INFORMATION)

See appendix pages vi-vii for surface material options.

Laminate Top with ABS Edge (-3MP)

- Choose Laminate
- Choose ABS Color

Laminate Top with Square Wood Edge (-SQP)

- Choose Laminate
- Choose Veneer Finish

Veneer Top with Square Wood Edge (-SQ)

- Choose Veneer Finish



ACCESSORIES

CASTERS	MODEL #	DESCRIPTION	PRICE
	FL-CST	Castors, set of 4	172

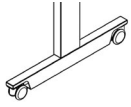

GENERAL INFORMATION

- For retrofitting in the field
- All four casters feature lock
- Wheels are hard ABS edge

REQUIRED INFORMATION: (ORDER CANNOT BE ENTERED WITHOUT THIS INFORMATION)

- See appendix pages vi-vii for surface material options.
- Choose Caster Color: Black or Smoke

GLIDES	MODEL #	DESCRIPTION	PRICE
	FL-GLD	Glides, set of 4	172

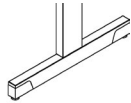

GENERAL INFORMATION

- For retrofitting in the field
- All four glides include an adjustable glide with 1-1/4" range

REQUIRED INFORMATION: (ORDER CANNOT BE ENTERED WITHOUT THIS INFORMATION)

- See appendix pages vi-vii for surface material options.
- Choose Metal Finish

GANGING CONNECTOR	MODEL #	DESCRIPTION	PRICE
	FL-GNG	Ganging Connectors, set of 2	249

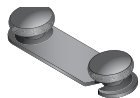

GENERAL INFORMATION

- For retrofitting in the field



POWER AND DATA OPTIONS

MODULAR POWER SYSTEM POWER INFEEDS	MODEL #	DESCRIPTION	PRICE
------------------------------------	---------	-------------	-------



FLP-H	Hardwire Power Infeed (20 amp)	165
FLP-P	Plug-In Power Infeed (20 amp)	219
FLP-P-SPLUG	Plug-In Power Infeed (20 amp) Straight Plug Head	219

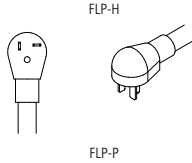

GENERAL INFORMATION

- Plug-in power infeed will only utilize one circuit of the two-circuit modular power system. To utilize both circuits, the hardwire power infeed must be specified.
- Power infeeds can be placed at any location along a string of connected tables
- Plug-in power infeed can accommodate a maximum of 6 tables per infeed. Hardwire power infeed can accommodate a maximum of 12 tables per infeed.

PLUG STRIP RETROFIT KIT	MODEL #	W x D x H	PRICE
-------------------------	---------	-----------	-------

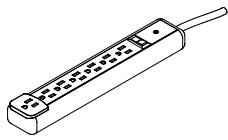

MOA-10	2.05 x 11.69 x 1.32	190
--------	---------------------	-----

GENERAL INFORMATION

- 15 amps - Mounts into Wire Trough
- Includes (7) outlets, surge protection and 12' electrical cord

MODULAR POWER SYSTEM RETROFIT KITS - RECTANGLE TABLES	MODEL #	PRICE
---	---------	-------

F-MOD42R	463
F-MOD48R	463
F-MOD54R	463
F-MOD60R	463
F-MOD66R	463
F-MOD72R	463

OPTIONS	CODE	PRICE	NOTES
Two-Circuit Version	Add -2CIR	No Charge	- Includes two receptacles, each accessing a different circuit - Only works with hardwired power infeeds

GENERAL INFORMATION

- Includes two receptacles (each on the same circuit unless the -2CIR option is specified) and one jumper to connect to adjacent table
- Standard version works with either hardwired or direct plug-in power infeeds (unless -2CIR option is selected, in which case it only works with hardwired power infeeds)

MODULAR POWER SYSTEM RETROFIT KITS - CONNECTING TOPS	MODEL #	PRICE
--	---------	-------

F-MOD30C	364
F-MOD90C	364

GENERAL INFORMATION

- Includes a jumper to connect to adjacent tables
- Works with either hardwired or direct plug-in power infeeds

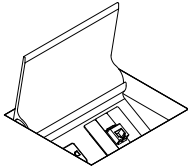

POWER AND DATA OPTIONS

POWER MATRIX COMPACT	MODEL #	DESCRIPTION	W x D	SIMPLEX OUTLETS	BLANK	DATA*	PRICE
	PM-SM-G-C	Small - Glass Door	6 x 5.375	2	2	1	1,549
	PM-SM-M-C	Small - Glass Metal	6 x 5.375	2	2	1	1,549
	PM-SM-W-C	Small - Wood Door	6 x 5.375	2	2	1	1,954

*Each data faceplate includes two RJ-45 (Data) connectors

OPTIONS	CODE	PRICE	NOTES
4 Simplex Receptacles	Add -FOUR	No Charge	Replace AAP's with 2 additional simplex receptacles
3 Simplex Receptacles/Charging USB-A+C	Add -THREE-C	No Charge	Replace AAP's with 1 additional simplex receptacle and 1 charging USB-A+C
USB-A+C Charging	Add -USB-C	\$121 per unit	USB-A+C charger, replaces one of the simplex outlets
Polished Chrome Door	Add -PD	\$232 per unit	Only available with metal door option
Polished Chrome Bezel	Add -PB	\$330 per unit	Only available on glass and laminate top tables
Field-Wired	Add -FW	Deduct \$45 per unit	May be required in New York City, Chicago and San Francisco. Check with an electrician for local codes and requirements.

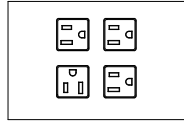

-FOUR

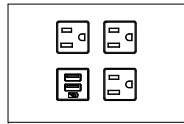

-THREE-C

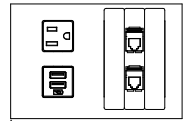

-USB-C

GENERAL INFORMATION

- Wood species and finish will default to the same as the table top if wood door version is specified
- Glass & wood doors are 1/4" -thick, metal doors are 1/8" -thick
- Glass door is back-painted low-iron glass
- Interior body is clear anodized aluminum
- Each unit includes a 15 amp, 12' power infeed (plug in only). If specified with modular power, the infeed will be 3' long.
- Standard configuration: Two simplex receptacles, two RJ-45 data connectors and two single blank faceplates
- When specified on tables with laminate tops, each Power Matrix unit will include a metal bezel and is limited to the glass and metal door options. (-B) will be added to the model number for the bezel.
- Additional data/AV faceplate options are below

REQUIRED INFORMATION: (ORDER CANNOT BE ENTERED WITHOUT THIS INFORMATION)

- See appendix pages vi-vii for surface material options.
- Choose Glass Door Finish, if glass door version is specified
 - Choose Metal Finish, if metal door version is specified or for the bezel finish on laminate tables

DATA FACEPLATES	MODEL #	DESCRIPTION	STYLE	W x H	PRICE
	FLDF-1	Blank faceplate, single height	Single	3-1/2 x 5/8	77
	FLDF-2	One VGA 15-pin HD Female to Female Gender Changer, one 3.5mm Stereo Mini Jack to Solder Tabs	Single	3-1/2 x 5/8	270
	FLDF-3	One VGA 15-pin HD Female to Female Gender Changer	Single	3-1/2 x 5/8	212
	FLDF-4	One RJ-11 Female to Punch Down - Phone	Single	3-1/2 x 5/8	212
	FLDF-5	One RJ-45 Female to Female Barrel - Data	Single	3-1/2 x 5/8	173
	FLDF-6	Two RJ-45 Female to Female Barrels, single height	Single	3-1/2 x 5/8	232
	FLDF-7	Two RJ-45 Female to Punch Down for CAT 6 - AMP	Single	3-1/2 x 5/8	328
	FLDF-8	Two RJ-45 Female to Punch Down for CAT 6 - Leviton	Single	3-1/2 x 5/8	328
	FLDF-10	Two RJ-45 Female to Punch Down for CAT 6 - Panduit	Single	3-1/2 x 5/8	328
	FLDF-11	Two USB A Female to Two USB A Female on 10" Pigtails	Single	3-1/2 x 5/8	367
	FLDF-12	Blank faceplate, double height	Double	3-1/2 x 1-3/8	96
	FLDF-13	Two RJ-45 Female to Female Barrels, double height	Double	3-1/2 x 1-3/8	232
	FLDF-14	Cable Pass-Through Set - one top, one bottom	Double	3-1/2 x 1-3/8	405
	FLDF-15	One HDMI Female to Female Barrel	Single	3-1/2 x 5/8	270

GENERAL INFORMATION

- All connectors and faceplates are Extron® Architectural Adapter Plates (AAP)
- Faceplates are black

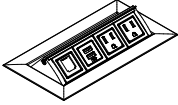

POWER AND DATA OPTIONS

TECH NODE	MODEL #	LOCATION	W X D	SIMPLEX RECEPTACLES	OPEN DATA PORTS	CHARGING USB-A+C	PRICE
 <p>PUP</p>  <p>PUP-USB-AC</p>	PUP	Centered, near edge	8 x 4	2	2	-	565
	PUP-C	Center of Table	8 x 4	2	2	-	565
	PUP-USB-AC	Centered, near edge	8 x 4	2	1	1	673
	PUP-USB-AC-C	Center of Table	8 x 4	2	1	1	673

OPTIONS	CODE	PRICE	NOTES
Field-Wired	Add -FW	No Charge	May be required in New York City, Chicago and San Francisco. Check with an electrician for local codes and requirements.

GENERAL INFORMATION

- 12' cord and a 15amp plug-in power infeed (3' cord when specified with two-circuit modular power system)
- Voice/data modules must be ordered separately; contact your local AV integrator
- Default color to metal finish specified on tables (Shadow, Storm, Black, Aged Bronze, Satin Bronze and Galaxy receive Black Anodized Tech Node; Cloud, Burnished and Foil receive Clear Anodized Tech Node)
- UL listed
- Not available on Connecting tops
- Centered near edge option not available on Inset-Mounted T-Leg Rectangle Tables
- Center of Table option only available on Inset-Mounted T-Leg Rectangle Tables
- Includes a Voice/Data Adapter Kit to accept couplers and jacks when required



GROMMET	MODEL #	DESCRIPTION	DIAMETER	PRICE
	GR	Centered, near edge	2" diameter	229
	GR2	Left & Right, near edge	2" diameter	457
	GR-C	Center of Table	2" diameter	229

GENERAL INFORMATION

- Not available on Connecting tops
- Left & Right option not available on Trapezoid, Sight Line, 42" and 48"-wide Rectangle Tables, or on T-Leg Inset-Mounted Rectangle Tables
- Centered, near edge option not available on T-Leg Inset-mounted Rectangle Tables
- Center of Table option only available on 30"-deep T-Leg Rectangle Tables and Inset-mounted T-Leg Rectangle Tables
- Metal finish will default to metal finish on table if powder coated

REQUIRED INFORMATION: (ORDER CANNOT BE ENTERED WITHOUT THIS INFORMATION)

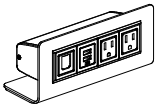
- See appendix pages vi-vii for surface material options.
- Choose Metal Finish: Powder Coat, Clear Anodized or Polished Chrome (upcharge applies)

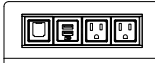
TECH ZONE	MODEL #	DESCRIPTION	SIMPLEX OUTLETS	OPEN DATA PORTS	CHARGING USB-A+C	PRICE
 <p>ZONE-USB-C</p>  <p>ZONE-DATA</p>  <p>ZONE-USB-C</p>	ZONE-DATA	(2) Simplex receptacles, (2) Open data ports	2	2	-	355
	ZONE-USB-C	(2) Simplex receptacles, (1) Charging USB-A+C, (1) Open data port	2	1	1	425

GENERAL INFORMATION

- 72" long plug-in infeed cord
- Finish is black
- Includes a Voice/Data Adapter Kit to accept couplers and jacks when required



Appendix



GENERAL INFORMATION

This price book supercedes all previous versions.

Before placing your order, confirm you have all required information necessary. Lead times for orders begin after all required information is included and correct.

Delivery Information

We know lead times are important and sticking to them even more so. We work to maintain a 6-8 week lead time on all standard products in this book from receipt of a clean order. All orders are acknowledged with an approximate shipping date and will be invoiced with the price in effect at the date the purchase order is received. For current lead times, please review www.nucraft.com/resources/lead-times.

Shipping charges are prepaid (within the continental U.S.). Therefore, pricing is a delivered price based on normal ground transportation. If you have special instructions, need to ship by air, or are shipping to Alaska or Hawaii, contact Nucraft Customer Service. Nucraft can also help arrange to have products blanket wrapped for an additional charge. Contact the Nucraft Customer Service team or specify it on your purchase order.

Minimum Freight Charge: Any order below \$2,900 net will be assessed a \$475 net minimum freight charge (one per order).

Orders are subject to acquiring the materials required for manufacturing. Fulfillment can be affected by strikes, fires, embargoes and acts of government. These elements are beyond our control.

Nucraft offers a variety of services to accommodate a wide range of delivery requirements. Availability of these services is dependent on a number of factors and may not be offered with all shipments. Examples of delivery services that have additional fees include:

- Specific date
- Specific time of day, morning or afternoon
- Delivery to a warehouse before delivery to its final destination (unless product is picked up at the warehouse)

Contact the Nucraft Customer Service team for availability and pricing on these services.

Freight Terms

Shipping charges for Nucraft products are prepaid for standard delivery in the continental United States. Standard delivery is defined as follows: Product is delivered on a 53' trailer being pulled by a long-haul tractor (total length of 85'). Facility will receive delivery Monday through Friday between the hours of 8:00 AM and 4:00 PM. Facility has docks with levelers and a fork truck for unloading. Product will be loaded on load bars two levels high. Receiving facility is responsible to have personnel on hand to unload the truck upon arrival, drivers do not unload. Delivery sites or times that do not meet these criteria may be accommodated, but will incur a charge to cover additional shipping costs. Please **notify Nucraft a minimum of two weeks prior to shipment** to arrange special services and determine additional charges.

Storage

Nucraft has no storage facilities for finished product. If a customer cannot accept an order when it is ready for shipment, the customer must designate an alternative shipping address. If no address is provided, Nucraft may, at its discretion, transfer the product to storage. If product is transferred to an off-site storage facility, the customer may be charged for transportation to the facility and for any associated storage fees. Nucraft considers transfer of the product to a storage facility the equivalent of shipment, including invoicing and payment. Customers assume the risk of damage or loss during storage.

Transportation Times and Delays

Third party carriers that Nucraft contracts with will make reasonable efforts to accommodate requested delivery times and dates. Scheduled delivery appointments may, however, be delayed for a variety of reasons, including inclement weather, traffic, transportation equipment problems, and delays encountered at other delivery locations along the delivery route. Nucraft does not recommend scheduling activities that depend on the delivery appointment (for example, scheduling furniture installers to install furniture the day of the delivery appointment). Nucraft shall not be liable for any costs incurred as a result of a missed delivery appointment.

Shipment Damage Claims

Legal title to merchandise passes to the buyer upon acceptance by the carrier. Inspect all cartons upon delivery. Details of visible damage should be noted on the delivery receipt. Do not destroy packaging, transport to site, or install product if damage is found upon inspection. Inspection of products should be completed upon delivery to the receiver. If visible damage is apparent, a claim should be filed immediately with Nucraft Customer Service. If visible damage is not apparent, sign the delivery receipt "No visible damage." This will allow recourse for a concealed damage claim. Concealed damage claims must be filed within 15 days of receipt, **prior to transporting or installing any product.**

Do not destroy packing materials until shipment has been inspected. If damage is found, proceed to file a claim with Nucraft Customer Service.

Failure to make any claims against Nucraft within 15 days shall constitute acceptance of the merchandise and a waiver of any defects, errors or shortages discovered upon inspection.

Cancellations

Cancellations must be reviewed by our Customer Service team. Because we build your products to order, orders cannot be cancelled once processing has begun. Processing includes but is not limited to development of shop drawings and other engineering drawings. If cancellation is approved, a processing fee of 20-100% will be assessed based on the status of the order.

Change Order Policy

Nucraft will make every attempt to honor any reasonable change request to product provided that the request is received prior to start of production. Change orders will be accepted only if the request is made in writing and received in time to make the change. Nucraft reserves the right to increase our acknowledged price and ship date if necessary to make the requested changes. Please submit any change order request to our Customer Service team. Nucraft will assess charges to the customer as stipulated in the following:

- Standard Orders: Change orders received prior to production will be charged \$400 net to cover administrative costs.
- Special Orders: Change orders received prior to production will be charged \$400 net to cover administrative costs. There may be additional costs associated with engineering labor required for the change order.
- Change orders received after production must be evaluated by Nucraft. If approved, the charge will be \$400 net plus any restocking charges accumulated. There may be additional costs associated with engineering and/or manufacturing labor, as well as material costs, required for the change order.



GENERAL INFORMATION

Repair Authorization

Prior written approval is required for repairs of merchandise charged to Nucraft. Failure to do so will result in customer funded repairs.

Payment Terms

Deposits are required at the time of order due to the custom nature of our products. See information regarding Cancellations above.

Credit terms are available to qualified customers. Please contact AR@Nucraft.com to start the application process. Note that the credit application process requires a valid sales tax exemption or resale tax certificate, Form W-9, and three current trade references.

Credit Card Payments are accepted via web portal. Please contact AR@Nucraft.com for payment instructions. Note that a 2% convenience fee will be added for using this payment method and no early pay discounts are allowed on credit card payments.

Warranty

Nucraft Furniture is warranted to be free from defects in materials and workmanship for a period of ten years of single shift use. Limitations include:

- Mechanical Devices such as latches, casters, and other moving components are warranted for five years of the date of original delivery.
- Height adjustable components are warranted for two years of the date of original delivery.
- The following are warranted for one year of the date of original delivery:
 - Textiles
 - Electrical Components
 - Refrigeration Units
 - Custom Products not described in Nucraft's Catalogue

This warranty is applicable only if furniture is properly installed and maintained in an office environment. This warranty extends only to products manufactured and sold in North America and only to original purchasers acquiring new Nucraft product through authorized dealers or approved sellers.

During this warranty period, Nucraft's sole obligation is to repair or replace, at Nucraft's discretion, products which prove to be defective during the warranty period.

This warranty does not cover:

- Damage caused by a carrier.
- Damage from user modification, misuse, abuse, accident, or negligence.
- Customer's Own Material (COM) specified by the customer that is not a standard product offering.
- Color, grain, or texture of wood and other covering material.

Nucraft extends no other warranties, expressed or implied, including warranty of merchantability or fitness for a particular purpose. Nucraft shall not be liable for loss of time, inconvenience, commercial loss, incidental or consequential damages.

Environmental Statement

Nucraft is committed to supporting responsible environmental policies and practices in all that we do. We strive for sustainability, weighing our business decisions against the costs to the ecological, social and economic systems they affect.

Our products are manufactured to meet the credit requirements of the U.S. Green Building Council's LEED rating systems in one or more of the following categories:

- Recycled Content
- Certified Wood
- Low-Emitting Materials

Computer Aided Planning

Nucraft products and pricing are available via CET and 2020 Cap, an AutoCAD®-based space planning tool.

2020 Cap is an integrated software system developed specifically for interior designers and facility planners to enhance workplace performance. This modern suite of applications works together seamlessly, in concert. Navigate catalogs, select products, design in plan view and 3D, assign options, create worksheets and build a project where you want, when you want. Take your pick. It's dynamic and interactive. Design projects are a work in progress. And now you can perform any of the many discrete tasks that go into a project any time, any place.

For additional information, you may contact 2020 Cap direct at 800-227-0038.

Product symbols (Revit, 2D and 3D) are available on the Nucraft website at www.nucraft.com/resources/product-symbols.

iSpec®

Nucraft offers a free online product configuration and specification service that saves you time and allows you to be creative while leaving the nuts and bolts to someone else. No specific software is required, nor is there any learning curve. This service applies to all Nucraft products. For additional information, call 1-877-NUCRAFT and ask for the iSpec Team or log on to www.nucraft.com/resources/ispec.



FINISH INFORMATION

Surface Materials Palette

We crafted our materials palette using the same demanding standards that distinguish our furniture. Thoughtful design and attention to every detail elevate your possibilities.

Anchored by Nucraft veneers, unrivaled for clarity, quality, and depth of finish, our collection of surface materials comprises a sophisticated set of balanced elements that supports your design vision.

Some elements have their roots in Nucraft's rich heritage. Others are new materials and reflect current trends and taste. Together, they ensure that you're ready for today and positioned well for the future. Beautifully.

Custom Finishes

Nucraft specializes in expert custom finish matching. For a nominal upcharge we can provide custom finishes, and we are frequently asked to match the finishes of other furniture manufacturers. For finishes that appear unusual to match or for customers directly requesting a sample, a finish sample will be sent for approval prior to entering the order.

Custom finishes requiring colored varnishes to create a painted look can only be applied to Maple veneer and require one extra week in addition to the standard lead time. Nucraft's standard black finish (G82) can be applied to all Nucraft standard veneers. Walnut is the standard black veneer. Other species must be specified when ordering.

Clear coat on a special veneer requires an approved sample.

Custom finishes carry a 10% upcharge per item, per finish, capped at \$2,100 List.

Custom finish upcharges are not applied to any item that is not wood. Example: casters, ganging connectors, power options..

Treatments

Note: Default veneer sheen will vary per finish and product. Default finish is bolded on pages vi-vii. If no direction is provided on incoming orders, default sheen will be selected. In addition, default veneer cut is noted in the price list. If no direction is provided on incoming orders, default cut will be selected.

Gloss: Gloss is a durable finish that tends to nicely mask normal wear and leaves wood grain visible to the eye. It achieves a medium gloss open pore appearance (40 – 50 sheen range). Finish numbers preceded by the letter "G" indicate a Gloss finish.

Matte: Like Gloss, Matte is durable, tends to nicely mask normal wear and leaves wood grain visible to the eye. It achieves a low luster, open pore appearance (10 – 20 sheen range). Finish numbers preceded by the letter "M" indicate a Matte finish.

Since each veneer type responds differently to both types of treatment, all will have a distinctive look and feel when finished. For example, a Walnut veneer with a Gloss treatment will remain much more textured than a Cherry veneer with the same treatment.

About the Wood

All Nucraft veneers are carefully selected for uniformity of color and grain. Still, wood is a natural substance and minor variations may occur due to its own uniqueness. Because of this, the furniture you receive may not be an exact match to our samples.

Nucraft takes great pride in our finish color consistency. However, wood is a natural product that will have color variation within a single piece of furniture, as well as from one piece to the next. Other factors also affect color over time, such as exposure to light (both intensity and duration). For example, lighter finishes cause more variation in colors over time.

In cases where a returning customer wants a precise match with existing furniture, we recommend sending a sample of the existing furniture finish. Please contact Nucraft Customer Service to determine an appropriate sample. This will ensure a finish match between old and new orders. This type of order is considered a control sample. There will be a 10% upcharge on an order of this type. Due to natural aging of veneers, natural finishes may vary.

Care and Maintenance of Wood Finishes

Our finish material is a crystal clear, urethane acrylic blend. This type of finish may be repaired in the field by a qualified refinisher.

Nucraft recommends using a damp cloth to clean your fine wood furniture. Always wipe with the grain of the wood. Should your wood furniture require a more thorough cleaning, we recommend using a mild cleaner such as Joy dish soap or Murphy's oil soap, thoroughly diluted in water (one part soap to thirty parts water). Water will not damage Nucraft's finish, but it may leave surface spots when it dries. To avoid this, dry the surface with a soft cloth after it is cleaned. Marks that cannot be removed with the cleaning methods above may be able to be removed using naphtha, a mild degreasing solvent.

Caution: while the use of polishes that contain wax, petroleum solvents or silicones may immediately enhance the "shine" of a product, it may also eventually remove the fine original finish applied in our factory. Silicone on the surface of wood may also make it very difficult to respray or refinish.

All Nucraft furniture is inspected and polished before it leaves our factory. In some instances, the packing materials may imprint on the factory polish. Cleaning and polishing the furniture once it is unpacked will normally restore the furniture to its original beauty.

In some cases, the rubber support feet used on the bottom of common office equipment (teleconferencing phones, laptops, microphones, copiers, etc.) can create unsightly marks in the surface of wood tops, due to oxidation of the lacquer finish. We suggest these machines be placed on a protective type of padding, such as felt.

Wood will fade as a result of exposure to UV light. This is particularly prevalent with light finishes. If color changes due to fading are a concern for your application, the impact can be minimized by selecting medium to dark stains for your wood surfaces. Our top coat includes a UV inhibitor which makes the finishes less prone to fading.



FINISH INFORMATION

Laminates

Selected Formica®, Nevamar®, and Wilsonart® laminates are available on Training Tables, Conference Tables, Conference Room Furniture and select Occasional Tables. For standard laminate and wood pricing, refer to individual item pricing columns.

Non-Standard Laminates and Linoleums

To order a color other than those on our list (see pages vi-vii), refer to Nevamar or Formica standard grade, matte texture laminate offerings and Forbo Furniture Linoleums (excluding manufacturers' non-standard matte offering).

Nucraft can support other laminate and linoleum options beyond what can be found as standard options on pages vi-viii. For pricing, please send a request to quotes@nucraft.com.

Care and Maintenance of Laminate and Novawrap

Laminate and Novawrap surfaces may be cleaned with a damp cloth and ordinary soap or non-abrasive household liquid detergent. Dry the surface with a clean cloth or soft paper towel to prevent streaks from appearing.

Care and Maintenance of Metal

Metal surfaces can be wiped with a damp cloth and rubbed dry. A mild non-abrasive household liquid detergent can be used if necessary. Regular maintenance of metal components, including tightening of fasteners and light lubrication of moving parts, will extend the life of your furniture.

Satin Etched Glass

Glass color may vary slightly on multi-piece conference table tops over 180" x 60" when satin etched glass is specified due to the iron content and etching process of the glass.

Care and Maintenance of Glass

Clear or frosted glass may be cleaned with commercial glass cleaner. Be sure to use a lint-free cloth if cleaning the frosted side of the glass.

Stone and Solid Surface Material

Despite its reputation for durability, natural stone can easily be broken during handling and/or installation if proper techniques are not followed. In addition, Nucraft is not responsible for the installation of natural stone or solid surface materials on its products. Therefore, installers specifically trained in the installation of these materials must be utilized to ensure a quality installation. Nucraft shall not be liable for any damages incurred during the handling and/or installation of natural stone or solid surface materials on its products.

Care and Maintenance of Granite

Granite surfaces may be cleaned with a damp cloth and ordinary soap or non-abrasive household liquid detergent. Dry the surface with a clean cloth or soft paper towel to prevent streaks from appearing.

Care and Maintenance of Leather

Genuine leather requires very little care. Nucraft recommends that leather be dusted regularly. If a more thorough cleaning is needed, use lukewarm water and a mild, non-abrasive soap. Generate some lather and lightly rub the surface with cheesecloth. Rinse off any soap film with clean water and towel dry. The leather may dry dull. To restore the leather to a normal gloss, rub it with a clean towel. Never use furniture polish, oil, varnish or ammonia. Saddle soap may be used to prevent the leather from becoming brittle or cracked and to maintain the original supple finish.

Touch Up Finish Kits

Model #	Description	Price
KIT-M	Metal Kit	85
KIT-P	Paint Kit	85
KIT-S	Stain Kit	85

REQUIRED INFORMATION:

(ORDER CANNOT BE ENTERED WITHOUT THIS INFORMATION)

- Kit model number
- Quantity of kits
- Specify finish (See pages vi-vii)

General Information:

- Touch-up kits must be ordered on a purchase order separate from Nucraft product due to Hazmat shipping

Retrofit & Replacements

If needing a partial placement or retrofit solution, please reach out to our quote team. Grain/color matched in a set.



FLEET™ SURFACE MATERIALS

WOOD FINISHES

STANDARD

Default veneer sheen will vary per finish and were determined by a team of experts who reviewed the colorways to determine if gloss or matte best highlighted the natural characteristics of the species of wood and the color of the stain. Default finish is bolded. If no direction is provided, default sheen will be selected.

	Matte	Gloss
Rift Cut Oak		
Carbon	M03	G03
Flat Cut Oak		
Dune	M05	G05
Portobello	M7413	G7413
Flaky Oak		
Sahara	M61	G61
Cherry		
Cognac	M21	G21
Auburn	M93	G93
Walnut		
Marron	M35	G35
Mocha	M33	G33
Zinc	M30	G30
Onyx	M82	G82
Otter	M31	G31
Maple		
Natural Maple	M60	G60
Linea		
Oak Linea	M08	G08
Walnut Linea	M27	G27
Euro Birch Linea	M09	G09
Silver Birch Linea	M10	G10
Paldo		
Thicket	M75	G75
Paldo	M76	G76
Canyon	M77	G77

METAL FINISHES

Powder Coat

Aged Bronze	A8010
Black	A44
Burnished	A8009
Cloud	A8004
Foil	A8006
Galaxy	A8007
Moonlight	A87
Satin Bronze	A8011
Shadow	A8005
Storm	A8012

Metal

Clear Anodized**	CA
High Polish Finish*	HPF

*Up-Charge applies. See specific product line pages for availability and details.

**Only available on Modesty Panels, Grommet, and Power Matrix metal doors.



LAMINATES

Wood Grain Laminates	Code	Coordinating Wood Finish	Coordinating Woodgrain Edgeband
Formica White Ash	8841-58	M8841	R8841
Formica Natural Ash	8843-58	M8843	R8843
Formica Aged Ash	8844-58	M8844	R8844
Formica Weathered Ash	8842-58	M8842	R8842
Formica Oiled Legno	8846-58	M8846	R8846
Formica Bleached Legno	8845-58	M8845	R8845
Formica Blackened Legno	8848-58	M8848	R8848
Formica Pecan Woodline	5883-58	M5883	R5883
Formica Chestnut Woodline	5884-58	M5884	R5884
Formica Urban Planked Oak	9312-58	M9312	R9312
Formica Thermo Walnut	6402-58	M6402	R6402
Formica Smoky Brown Pear	5488-58	M5488	R5488
Formica Espresso Pear	5489-58	M5489	R5489
Formica Sand Maple	9237-58	G60	W7909
Formica Planked Coffee Oak	7413-58	M7413	F7413

Solid Laminates

Formica Brite White	459-58	R01
Formica Dover White	7197-58	R01
Formica Pearl	934-58	R02
Formica Graystone	464-58	R02
Formica Folkstone	927-58	R03
Formica Graphite	837-58	R05

Patterned Laminates

Nevamar Cool Chic	VA7002T	R02
Nevamar Serene Stardom	VA5001T	R05
Nevamar Calm Distinction	VA6001T	R05
Nevamar Easy Elegance	VA5002T	R05
Wilsonart Sheer Mesh	4876-38	R02
Wilsonart Grey Mesh	4877-38	R02
Wilsonart Pewter Mesh	4878-38	R05

ABS FINISHES

Ashen	R04
Parchment	R02
Shale	R05
Stone	R03
Whitecap	R01