

FLOW™ CREDENZA

Planning Guide + Price List

QUICK LINKS

[PLANNING GUIDE](#)

[FLOW CREDENZA PRICING](#)

[GENERAL INFORMATION](#)

[FINISH INFORMATION](#)

[SURFACE MATERIALS](#)



TABLE OF CONTENTS

Click the shortcuts below to jump to each section.

General Information	ii-iii
Finish Information	iv-v
Surface Materials	vi-viii

Statement of Line	3
Specification Overview	4

FLOW CREDENZA

Exterior Components	5
Interior Components	6
Base Styles	7
Door Styles	8
Dimensions	9
Price List	10-79
Veneer Top with Hardwood Edge	10-19
Laminate Top with Hardwood Edge	20-29
Laminate Top with ABS Edge	30-39
Gloss Glass Top	40-49
Satin Glass Top	50-59
Stone Top	60-69
Solid Surface Top	70-79

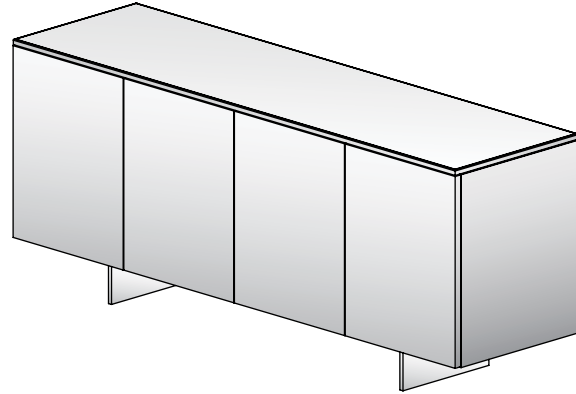



STATEMENT OF LINE

CASE STYLE

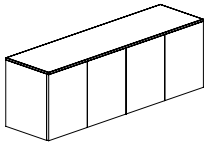

Conference Height

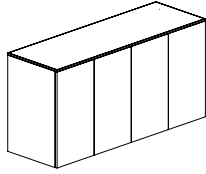

Buffet Height

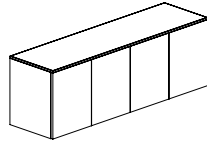

Low Height

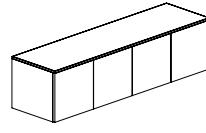

Wall-Hung

BASE STYLE

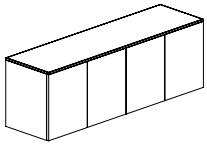

Case Only

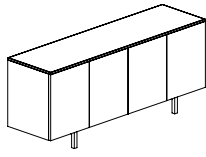

Inset Leg

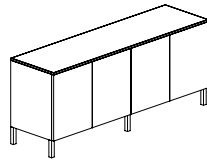

Edge-mount Leg

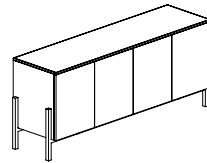

Cradle

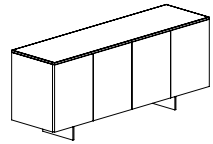

Blade



SPECIFICATION OVERVIEW

FLOW CREDENZA

1. Select Top Material

Choose from veneer, stone, glass, solid-surface, or laminate.

2. Select Base Style

Choose case only, or one of four base styles: inset, edge-mount, cradle, or blade. All base styles are available in powder coat or polished metal.

3. Select Case Material

Choose laminate, painted, or veneer. All standard laminates and veneers are available as well as a variety of paint options.

4. Select Case Size

First pick the credenza height: wall-hung, low, conference, or buffet. Then choose the number of doors: 2, 3, 4, or 5.

5. Select Door Style

Pick a design: vertical veneer, horizontal, and plank veneer styles, or painted and veneer door front combinations.

6. Select Options

- Locks
- A cutout and thermostatically-controlled fan can be added to the back panel for cable management and to remove heat generated by enclosed equipment
- Additional components:
 - One pull-out drawer behind each door
 - Front-opening single or double waste bin system
 - Sliding or fixed equipment racks



EXTERIOR COMPONENTS

TOP MATERIALS AND EDGE PROFILES

- Veneer tops are 3/4"-thick with a 3/16"-deep hardwood square edge band
- Laminate tops with a hardwood edge are 3/4"-thick with a 3/16"-deep edge band
- Laminate tops are 3/4"-thick with a 2 mm ABS edge
- Glass is 1/4"-thick back-painted, low-iron glass
- Stone tops are 2 cm thick
- Solid surface tops are 1/2"-thick

DOOR STYLES

- Laminate door style will match laminate case finish. Vertical direction if woodgrain laminate is specified.
- Vertical veneer direction in a slip-match layup is available in all standard wood species and finishes
- Horizontal veneer direction is available in both slip-match and book-match layups dependent upon wood species
- Plank offers dramatic variations in veneer leaf color, length, and natural characteristics; it simulates randomly matched veneers
- Painted and veneer combinations

BASE STYLES

- Case only selection includes a full-size case with .5" adjustable glides
- All metal post leg options are 1.25" square
 - Inset leg
 - Edge-mount leg, located just inside the case
 - Cradle base sits proud on each side
- The metal blade leg option is .5"-thick, inset, and runs the depth of the credenzas
- Finishes for all metal legs:
 - Powder coat
 - Polished

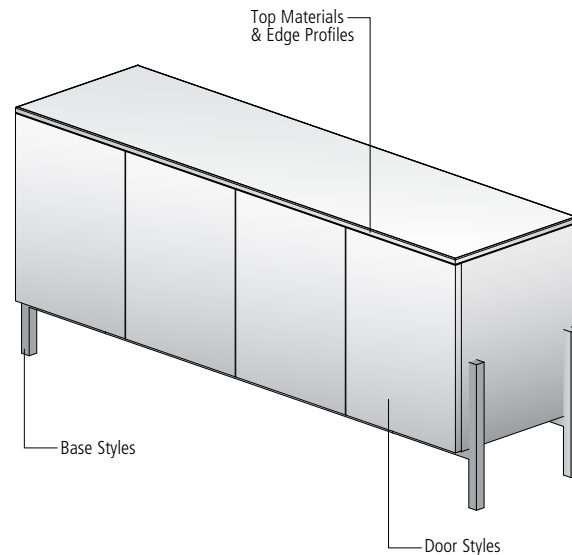

VENTILATION AND CUTOUTS

Equipment racks include two cutouts:

- A 9"x9" cutout in the back panel is located behind the rack in the leftmost two-door cabinet
- A round cutout accommodates a thermostatically-controlled fan; that activates automatically at 87° F and turns off when the ambient temperature in the cabinet reaches 85° F; cables can also be routed into the case through the cutout in the back panel
- Available on all buffet height and case only conference height credenzas

Ventilation & Cutouts

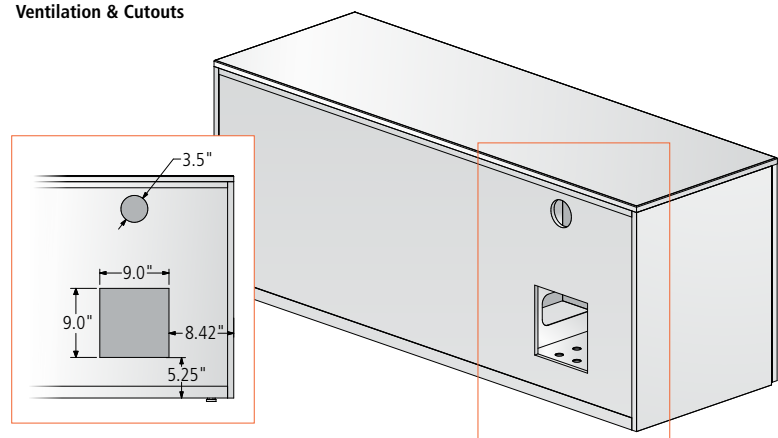



INTERIOR COMPONENTS

SHELF & DRAWER OPTIONS

- Adjustable shelves are standard
- One drawer behind each credenza door may also be specified on buffet height (case only) credenzas
 - Maple drawer box with applied front. Fronts to match case exterior.

Shelf and Drawer Options

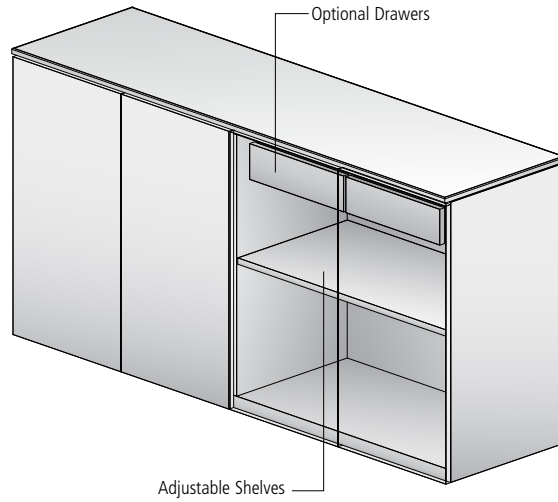

WASTE AND RECYCLING

- A front-opening single waste bin system is available on 20"-deep credenzas
 - Bin Size: 14" x 10.5" x 18"; (1) 36 Qt.
- A front-opening double waste bin system is available on 24"-deep credenzas
 - Bin Size: 14" x 10.5" x 18"; (2) 36 Qt.
- Both options are offered on the low height (case only), conference height, or buffet height credenzas; located behind the rightmost door
- Shelf not included if Waste/Recycling unit specified

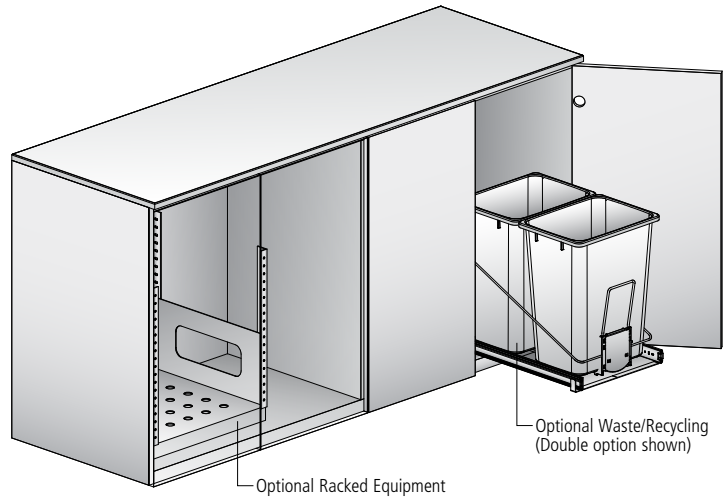

RACKED EQUIPMENT

- Select from sliding or fixed equipment racks
- Equipment racks hold 12RU and include a thermostatically-controlled fan, plugstrip, and a 9"x9" cutout in the back panel behind the rack
- Available on all buffet height and case only conference height credenzas; located in the leftmost two-door cabinet

COMPONENT DIMENSIONS:

Single Waste/Recycling

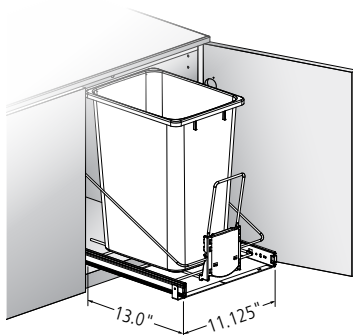

Double Waste/Recycling

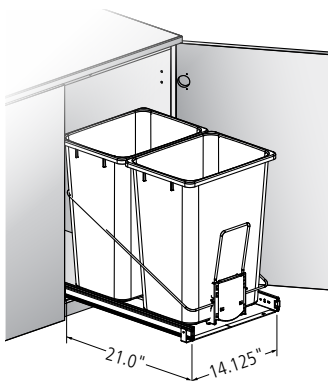

Drawers

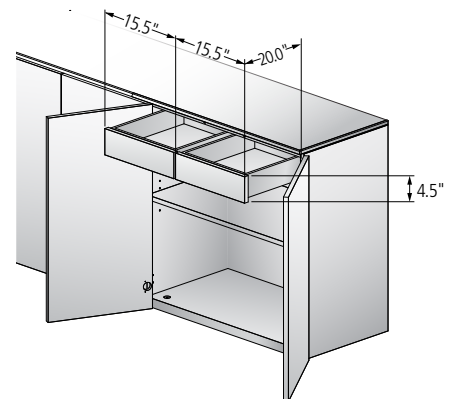



BASE STYLES

CASE

This selection includes a full-size case with adjustable glides.

Case



INSET LEG

Inset metal frame is 1.25" square and 6.5" in height; available in powder coat or polished finish.

Inset Leg

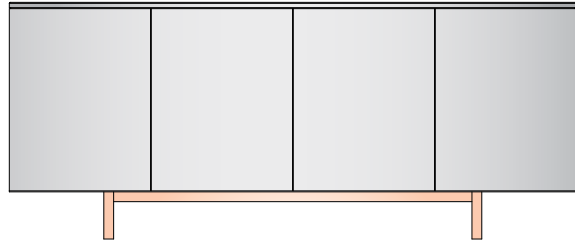

EDGE-MOUNT POST LEG

The edgemount metal post leg is 1.25" square and 6.5" in height; available in powder coat or polished finish. Four post legs located on each corner for 36" – 54" wide credenzas. Two additional legs centered front and back for 72" – 90" wide credenzas.

Edge-mount Post Leg

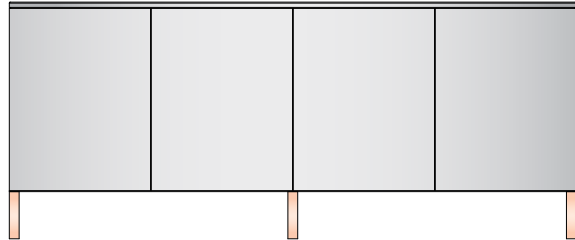

CRADLE BASE

The cradle H-frame is 1.25" square and 6.5" in height; available in powder coat or polished finish. The metal frame runs 10.5" up on each side and runs the length of the credenza.

Cradle Base

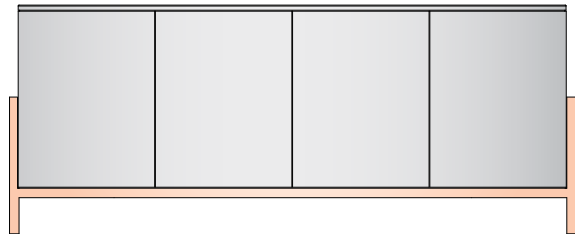

BLADE BASE

The metal blade leg option is 1.5"-thick, 6.5" in height, and 14" in length, running the depth of the credenza. Available in powder coat or polished finish.

Blade Base

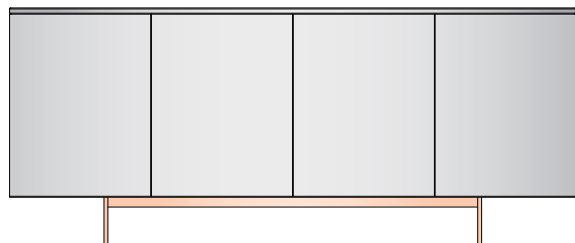



DOOR STYLES

Veneer direction on door interior will be vertical. Veneer case will be vertical slip-match layup regardless of veneer door style selection. Veneer top will run the length of the case. Paint and laminate door interior will match door exterior. Laminate wood grain direction will be vertical on door and case. Case interior will match the case exterior. Laminate wood grain top will run the length of the case.

Vertical Veneer and Woodgrain Laminates

Doors with a vertical veneer direction feature a slip-match layup and are available in all wood finishes.

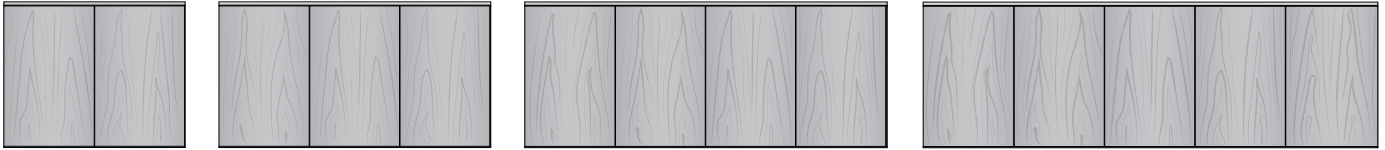

Horizontal Veneer

Doors with a horizontal veneer direction are available in all wood species and finishes.

Book-match layup available in Ash, Cherry, and Walnut.

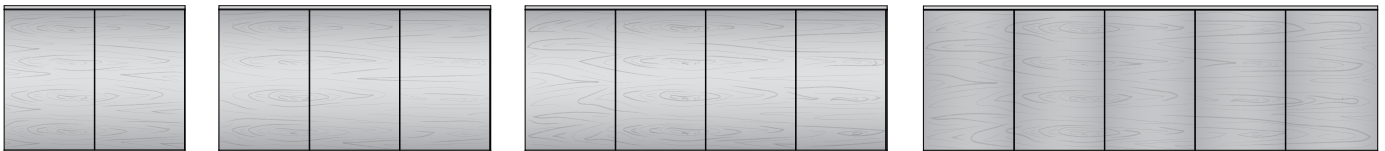

Slip-match layup available in Rift-Cut, Paldao, Linea, Quartered Figured Anigre, and Black Limba.



Plank Veneer

Available in walnut, plank offers dramatic variations in veneer leaf color, length, and natural characteristics; simulates randomly matched veneers. Veneer top and case are flat-cut (non-plank) clear coat walnut and feature a vertical slip-match layup. Coordinating case finish captures color variation to complement the variation of the plank door style.

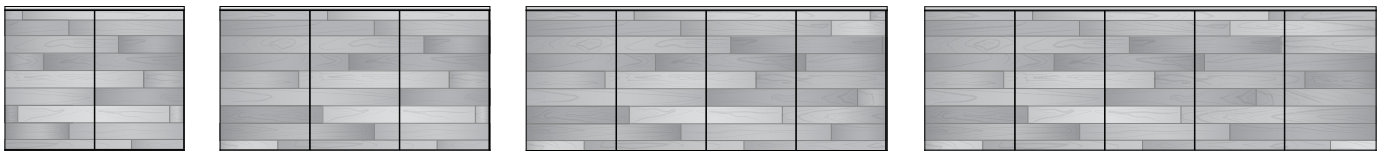

Painted and Veneer Combinations

Available on all credenzas in any door or base style. If specified, a paint finish must be selected. Case interior will always match the finish of the case exterior.

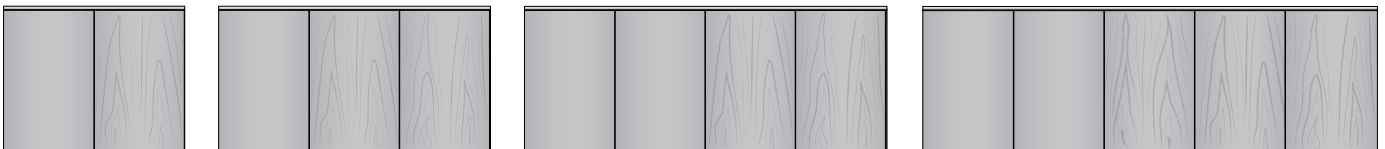



DIMENSIONS

DIMENSIONS

All Credenzas 54" and wider include vertical panels that divide the interior into two or three sections depending on credenza width. Dimensions A, B, and C reflect the width of each section. Exterior heights excludes top material thickness. Add top material for total height:

Veneer, Laminate and Stone - .75"

Glass - .25"

Solid Surface - .5"

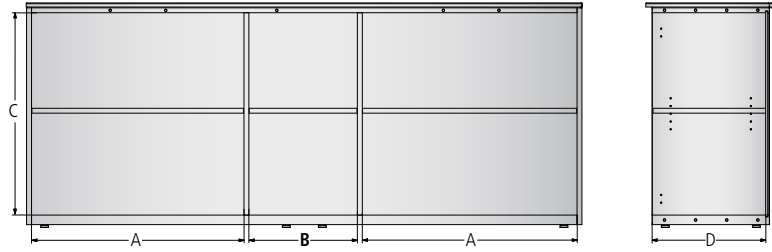

WALL-HUNG



Interior Dimensions				
Exterior	A	B	C	D
36"W x 20"D x 17.2"H	34.4	-	14.75	18
54"W x 20"D x 17.2"H	34.4	17.2	14.75	18
72"W x 20"D x 17.2"H	34.4	34.4	14.75	18
90"W x 20"D x 17.2"H	34.4	17.6	14.75	18

LOW HEIGHT CRENDENZA

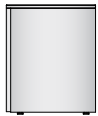

Case Only; Interior Dimensions				
Exterior	A	B	C	D
36"W x 20"D x 23.7"H	34.4	-	20.8	18
54"W x 20"D x 23.7"H	34.4	17.2	20.8	18
72"W x 20"D x 23.7"H	34.4	34.4	20.8	18
90"W x 20"D x 23.7"H	34.4	17.6	20.8	18

Case Only; Interior Dimensions				
Exterior	A	B	C	D
36"W x 24"D x 23.7"H	34.4	-	20.8	22
54"W x 24"D x 23.7"H	34.4	17.2	20.8	22
72"W x 24"D x 23.7"H	34.4	34.4	20.8	22
90"W x 24"D x 23.7"H	34.4	17.6	20.8	22

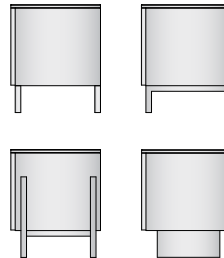

Metal Leg; Interior Dimensions				
Exterior	A	B	C	D
36"W x 20"D x 23.7"H	34.4	-	14.75	18
54"W x 20"D x 23.7"H	34.4	17.2	14.75	18
72"W x 20"D x 23.7"H	34.4	34.4	14.75	18
90"W x 20"D x 23.7"H	34.4	17.6	14.75	18

CONFERENCE HEIGHT CRENDENZA



Case Only; Interior Dimensions				
Exterior	A	B	C	D
36"W x 20"D x 28.7"H	34.4	-	25.8	18
54"W x 20"D x 28.7"H	34.4	17.2	25.8	18
72"W x 20"D x 28.7"H	34.4	34.4	25.8	18
90"W x 20"D x 28.7"H	34.4	17.6	25.8	18

Case Only; Interior Dimensions				
Exterior	A	B	C	D
36"W x 24"D x 28.7"H	34.4	-	25.8	22
54"W x 24"D x 28.7"H	34.4	17.2	25.8	22
72"W x 24"D x 28.7"H	34.4	34.4	25.8	22
90"W x 24"D x 28.7"H	34.4	17.6	25.8	22

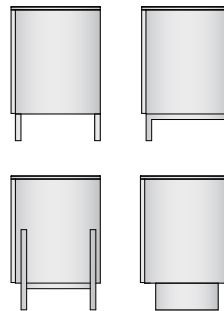

Metal Leg; Interior Dimensions				
Exterior	A	B	C	D
36"W x 20"D x 29.7"H	34.4	-	20.8	18
54"W x 20"D x 29.7"H	34.4	17.2	20.8	18
72"W x 20"D x 29.7"H	34.4	34.4	20.8	18
90"W x 20"D x 29.7"H	34.4	17.6	20.8	18

Metal Leg; Interior Dimensions				
Exterior	A	B	C	D
36"W x 24"D x 29.7"H	34.4	-	20.8	22
54"W x 24"D x 29.7"H	34.4	17.2	20.8	22
72"W x 24"D x 29.7"H	34.4	34.4	20.8	22
90"W x 24"D x 29.7"H	34.4	17.6	20.8	22

BUFFET HEIGHT CRENDENZA



Case Only; Interior Dimensions				
Exterior	A	B	C*	D
36"W x 20"D x 35.7"H	34.4	-	32.8	18
54"W x 20"D x 35.7"H	34.4	17.2	32.8	18
72"W x 20"D x 35.7"H	34.4	34.4	32.8	18
90"W x 20"D x 35.7"H	34.4	17.6	32.8	18

Case Only; Interior Dimensions				
Exterior	A	B	C*	D
36"W x 24"D x 35.7"H	34.4	-	32.8	22
54"W x 24"D x 35.7"H	34.4	17.2	32.8	22
72"W x 24"D x 35.7"H	34.4	34.4	32.8	22
90"W x 24"D x 35.7"H	34.4	17.6	32.8	22

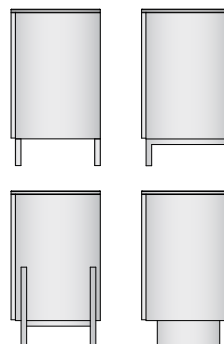

Metal Leg; Interior Dimensions				
Exterior	A	B	C	D
36"W x 20"D x 34.7"H	34.4	-	25.8	18
54"W x 20"D x 34.7"H	34.4	17.2	25.8	18
72"W x 20"D x 34.7"H	34.4	34.4	25.8	18
90"W x 20"D x 34.7"H	34.4	17.6	25.8	18

Metal Leg; Interior Dimensions				
Exterior	A	B	C	D
36"W x 24"D x 34.7"H	34.4	-	25.8	22
54"W x 24"D x 34.7"H	34.4	17.2	25.8	22
72"W x 24"D x 34.7"H	34.4	34.4	25.8	22
90"W x 24"D x 34.7"H	34.4	17.6	25.8	22

*Subtract 6" from height if credenza includes drawer option.



VENEER TOP WITH HARDWOOD EDGE

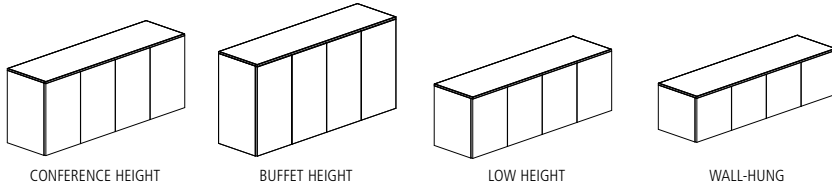

CASE MATERIAL KEY

PA Painted Case
V Veneer Case

CASE ONLY

MODEL #	W x D x H	DESCRIPTION	-PA	-V
CONFERENCE HEIGHT (29.5 INCH CASE)				
FWCC-3629-W	36 x 20 x 29.5	Two Doors	5,258	5,562
FWCC-5429-W	54 x 20 x 29.5	Three Doors	6,844	7,242
FWCC-7229-W	72 x 20 x 29.5	Four Doors	8,431	8,923
FWCC-9029-W	90 x 20 x 29.5	Five Doors	10,020	10,602
FWCD-3629-W	36 x 24 x 29.5	Two Doors	5,781	6,116
FWCD-5429-W	54 x 24 x 29.5	Three Doors	7,527	7,965
FWCD-7229-W	72 x 24 x 29.5	Four Doors	9,276	9,815
FWCD-9029-W	90 x 24 x 29.5	Five Doors	11,020	11,660
BUFFET HEIGHT (36.5 INCH CASE)				
FWBC-3636-W	36 x 20 x 36.5	Two Doors	6,044	6,397
FWBC-5436-W	54 x 20 x 36.5	Three Doors	7,869	8,324
FWBC-7236-W	72 x 20 x 36.5	Four Doors	9,694	10,257
FWBC-9036-W	90 x 20 x 36.5	Five Doors	11,520	12,189
FWBD-3636-W	36 x 24 x 36.5	Two Doors	6,649	7,034
FWBD-5436-W	54 x 24 x 36.5	Three Doors	8,654	9,157
FWBD-7236-W	72 x 24 x 36.5	Four Doors	10,662	11,283
FWBD-9036-W	90 x 24 x 36.5	Five Doors	12,671	13,406
LOW HEIGHT (24.5 INCH CASE)				
FWLC-3624-W	36 x 20 x 24.5	Two Doors	4,869	5,151
FWLC-5424-W	54 x 20 x 24.5	Three Doors	6,338	6,708
FWLC-7224-W	72 x 20 x 24.5	Four Doors	7,808	8,261
FWLC-9024-W	90 x 20 x 24.5	Five Doors	9,278	9,818
FWLD-3624-W	36 x 24 x 24.5	Two Doors	5,355	5,664
FWLD-5424-W	54 x 24 x 24.5	Three Doors	6,971	7,378
FWLD-7224-W	72 x 24 x 24.5	Four Doors	8,587	9,088
FWLD-9024-W	90 x 24 x 24.5	Five Doors	10,204	10,795
WALL-HUNG (18 INCH CASE)				
FWWC-3618-W	36 x 20 x 18	Two Doors	4,469	4,729
FWWC-5418-W	54 x 20 x 18	Three Doors	5,820	6,156
FWWC-7218-W	72 x 20 x 18	Four Doors	7,168	7,582
FWWC-9018-W	90 x 20 x 18	Five Doors	8,517	9,010

DOOR STYLE

DESCRIPTION	CODE	NOTES	PRICE
Plank Veneer	-PWD	Available in Clear Coat Walnut	\$289
Vertical Veneer	-VD		No Charge
Horizontal Veneer	-HD		No Charge
Veneer/Paint Combination	-VPD	Reference page 8 for predetermined accent door locations	No Charge
Painted	-PAD		No Charge



VENEER TOP WITH HARDWOOD EDGE

OPTIONS	CODE	PRICE	NOTES
Locks	Add -LK	\$289	
Drawers Behind Doors (Buffet Height - 36" Case Only)	Add -D	\$564	
Equipment Rack Options - Conference Height and Buffet Height Credenzas:			
Fixed Equipment Rack	Add -R2	\$871	Available for 24" deep Credenzas, behind the left most pair of doors
Sliding Equipment Rack	Add -R1	\$3,174	Available for 24" deep Credenzas, behind the left most pair of doors
Waste/Recycling Unit Options:			
Single Pull-Out Waste/Recycling Unit	Add -TF1	\$283	Available for 20" deep Credenzas only (Wall-Hung excluded), behind right most doors
Double Pull-Out Waste/Recycling Unit	Add -TF2	\$438	Available for 24" depth credenzas only (Wall-Hung excluded), behind right most doors

REQUIRED INFORMATION (ORDER CANNOT BE ENTERED WITHOUT THIS INFORMATION):

See pages vi-vii for surface material options.

- Choose Door Style: Defaults to case finish, if none selected
- Choose Wood Species & Finish
- Choose Paint Finish, if specified

GENERAL INFORMATION

- Tops are 3/4"-thick with 3/16"-deep hardwood edge band
- Plank veneer is hand selected walnut veneers of varying character and color, with a clear coat finish, to accentuate the plank appearance
- When Plank veneer door style is specified with a veneer case, case and top will default to clear coat walnut in standard slip-match layup
- When veneer case is specified, the case exterior is standard slip-match layup regardless of veneer door style selection
- Pull-Out Waste/Recycling Bin size: 14" x 10-1/2" x 18"; (1) 36 Qt.; Double Pull-Out Waste/Recycling Units include two bins
- Locks
 - Veneer (Case Only) - When lock option is specified, color will default to Satin Nickel
 - Painted (Case Only) - When lock option is specified, color will default based on Paint finish:
 - Aged Bronze, Black, Galaxy, Shadow, and Storm: Black
 - Cloud: White
 - Burnish, Foil, Satin Bronze: Satin Nickel
 - Chrome: Polished Nickel
- Credenzas include one adjustable shelf behind each door unless other components are specified
- Equipment racks hold 12RU and include a thermostatically controlled fan and plug strip



VENEER TOP WITH HARDWOOD EDGE

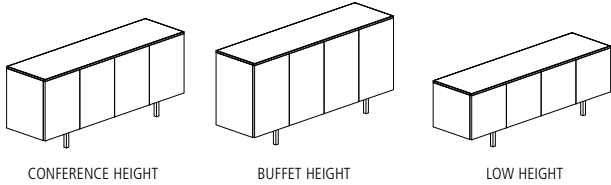

CASE MATERIAL KEY

PA-IB Painted Case with Inset Leg
 V-IB Veneer Case with Inset Leg

INSET LEG

MODEL #	W x D x H	DESCRIPTION	-PA-IB	-V-IB
CONFERENCE HEIGHT (24 IN. CASE WITH 6.5 IN. INSET LEG)				
FWLC-3629-W	36 x 20 x 30.5	Two Doors	5,298	5,579
FWLC-5429-W	54 x 20 x 30.5	Three Doors	6,767	7,135
FWLC-7229-W	72 x 20 x 30.5	Four Doors	8,232	8,691
FWLC-9029-W	90 x 20 x 30.5	Five Doors	9,706	10,245
FWLD-3629-W	36 x 24 x 30.5	Two Doors	5,781	6,092
FWLD-5429-W	54 x 24 x 30.5	Three Doors	7,399	7,807
FWLD-7229-W	72 x 24 x 30.5	Four Doors	9,015	9,516
FWLD-9029-W	90 x 24 x 30.5	Five Doors	10,633	11,225
BUFFET HEIGHT (29 IN. CASE WITH 6.5 IN. INSET LEG)				
FWCC-3636-W	36 x 20 x 35.5	Two Doors	5,685	5,988
FWCC-5436-W	54 x 20 x 35.5	Three Doors	7,272	7,670
FWCC-7236-W	72 x 20 x 35.5	Four Doors	8,860	9,349
FWCC-9036-W	90 x 20 x 35.5	Five Doors	10,447	11,028
FWCD-3636-W	36 x 24 x 35.5	Two Doors	6,211	6,543
FWCD-5436-W	54 x 24 x 35.5	Three Doors	7,954	8,396
FWCD-7236-W	72 x 24 x 35.5	Four Doors	9,701	10,241
FWCD-9036-W	90 x 24 x 35.5	Five Doors	11,448	12,088
LOW HEIGHT (18 IN. CASE WITH 6.5 IN. INSET LEG)				
FWWC-3624-W	36 x 20 x 24.5	Two Doors	4,899	5,159
FWWC-5424-W	54 x 20 x 24.5	Three Doors	6,249	6,586
FWWC-7224-W	72 x 20 x 24.5	Four Doors	7,595	8,010
FWWC-9024-W	90 x 20 x 24.5	Five Doors	8,947	9,439

DOOR STYLE

DESCRIPTION	CODE	NOTES	PRICE
Plank Veneer	-PWD	Available in Clear Coat Walnut	\$289
Vertical Veneer	-VD		No Charge
Horizontal Veneer	-HD		No Charge
Veneer/Paint Combination	-VPD	Reference page 8 for predetermined accent door locations	No Charge
Painted	-PAD		No Charge

OPTIONS	CODE	PRICE	NOTES
Locks	Add -LK	\$289	
Polished Chrome Base	Add -PCIB	\$460	
Equipment Rack Options - Buffet Height Credenzas:			
Fixed Equipment Rack	Add -R2	\$871	Available for 24" deep Credenzas, behind the left most pair of doors
Sliding Equipment Rack	Add -R1	\$3,174	Available for 24" deep Credenzas, behind the left most pair of doors
Waste/Recycling Unit Options:			
Single Pull-Out Waste/Recycling Unit	Add -TF1	\$283	Available for 20" deep Credenzas only (Wall-Hung excluded), behind right most doors
Double Pull-Out Waste/Recycling Unit	Add -TF2	\$438	Available for 24" depth credenzas only (Wall-Hung excluded), behind right most doors



VENEER TOP WITH HARDWOOD EDGE

REQUIRED INFORMATION (ORDER CANNOT BE ENTERED WITHOUT THIS INFORMATION):

See pages vi-vii for surface material options.

- Choose Door Style: Defaults to case finish, if none selected
- Choose Metal Finish
- Choose Wood Species & Finish
- Choose Paint Finish, if specified

GENERAL INFORMATION

- Tops are 3/4" -thick with 3/16" -deep hardwood edge band
- Plank veneer is hand selected walnut veneers of varying character and color, with a clear coat finish, to accentuate the plank appearance
- When Plank veneer door style is specified with a veneer case, case and top will default to clear coat walnut in standard slip-match layup
- When veneer case is specified, the case exterior is standard slip-match layup regardless of veneer door style selection
- Pull-Out Waste/Recycling Bin size: 14" x 10-1/2" x 18"; (1) 36 Qt.; Double Pull-Out Waste/Recycling Units include two bins
- When lock option is specified, color will default based on leg finish:
 - Aged Bronze, Black, Galaxy, Shadow, and Storm: Black
 - Cloud: White
 - Burnish, Foil, and Satin Bronze: Satin Nickel
 - Chrome: Polished Nickel
- Credenzas include one adjustable shelf behind each door unless other components are specified
- Equipment racks hold 12RU and include a thermostatically controlled fan and plug strip



VENEER TOP WITH HARDWOOD EDGE

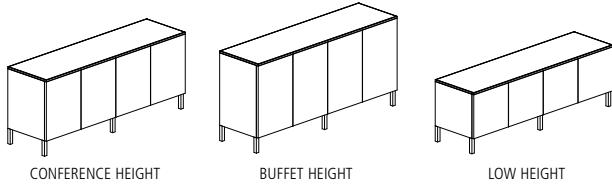

CASE MATERIAL KEY

PA-OB Painted Case with Edge-mount Post Leg
 V-OB Veneer Case with Edge-mount Post Leg

EDGE-MOUNT POST LEG

MODEL #	W x D x H	DESCRIPTION	-PA-OB	-V-OB
CONFERENCE HEIGHT (24 IN. CASE WITH 6.5 IN. EDGE-MOUNT POST LEG)				
FWLC-3629-W	36 x 20 x 30.5	Two Doors	5,298	5,579
FWLC-5429-W	54 x 20 x 30.5	Three Doors	6,767	7,135
FWLC-7229-W	72 x 20 x 30.5	Four Doors	8,232	8,691
FWLC-9029-W	90 x 20 x 30.5	Five Doors	9,706	10,245
FWLD-3629-W	36 x 24 x 30.5	Two Doors	5,781	6,092
FWLD-5429-W	54 x 24 x 30.5	Three Doors	7,399	7,807
FWLD-7229-W	72 x 24 x 30.5	Four Doors	9,015	9,516
FWLD-9029-W	90 x 24 x 30.5	Five Doors	10,633	11,225
BUFFET HEIGHT (29 IN. CASE WITH 6.5 IN. EDGE-MOUNT POST LEG)				
FWCC-3636-W	36 x 20 x 35.5	Two Doors	5,685	5,988
FWCC-5436-W	54 x 20 x 35.5	Three Doors	7,272	7,670
FWCC-7236-W	72 x 20 x 35.5	Four Doors	8,860	9,349
FWCC-9036-W	90 x 20 x 35.5	Five Doors	10,447	11,028
FWCD-3636-W	36 x 24 x 35.5	Two Doors	6,211	6,543
FWCD-5436-W	54 x 24 x 35.5	Three Doors	7,954	8,396
FWCD-7236-W	72 x 24 x 35.5	Four Doors	9,701	10,241
FWCD-9036-W	90 x 24 x 35.5	Five Doors	11,448	12,088
LOW HEIGHT (18 IN. CASE WITH 6.5 IN. EDGE-MOUNT POST LEG)				
FWWC-3624-W	36 x 20 x 24.5	Two Doors	4,899	5,159
FWWC-5424-W	54 x 20 x 24.5	Three Doors	6,249	6,586
FWWC-7224-W	72 x 20 x 24.5	Four Doors	7,595	8,010
FWWC-9024-W	90 x 20 x 24.5	Five Doors	8,947	9,439

DOOR STYLE

DESCRIPTION	CODE	NOTES	PRICE
Plank Veneer	-PWD	Available in Clear Coat Walnut	\$289
Vertical Veneer	-VD		No Charge
Horizontal Veneer	-HD		No Charge
Veneer/Paint Combination	-VPD	Reference page 8 for predetermined accent door locations	No Charge
Painted	-PAD		No Charge

OPTIONS	CODE	PRICE	NOTES
Locks	Add -LK	\$289	
Polished Chrome Base	Add -PCOB	\$497	
Equipment Rack Options - Buffet Height Credenzas:			
Fixed Equipment Rack	Add -R2	\$871	Available for 24" deep Credenzas, behind the left most pair of doors
Sliding Equipment Rack	Add -R1	\$3,174	Available for 24" deep Credenzas, behind the left most pair of doors
Waste/Recycling Unit Options:			
Single Pull-Out Waste/Recycling Unit	Add -TF1	\$283	Available for 20" deep Credenzas only (Wall-Hung excluded), behind right most doors
Double Pull-Out Waste/Recycling Unit	Add -TF2	\$438	Available for 24" depth credenzas only (Wall-Hung excluded), behind right most doors



VENEER TOP WITH HARDWOOD EDGE

REQUIRED INFORMATION (ORDER CANNOT BE ENTERED WITHOUT THIS INFORMATION):

See pages vi-vii for surface material options.

- Choose Door Style: Defaults to case finish, if none selected
- Choose Metal Finish
- Choose Wood Species & Finish
- Choose Paint Finish, if specified

GENERAL INFORMATION

- Tops are 3/4" -thick with 3/16" -deep hardwood edge band
- Plank veneer is hand selected walnut veneers of varying character and color, with a clear coat finish, to accentuate the plank appearance
- When Plank veneer door style is specified with a veneer case, case and top will default to clear coat walnut in standard slip-match layup
- When veneer case is specified, the case exterior is standard slip-match layup regardless of veneer door style selection
- Pull-Out Waste/Recycling Bin size: 14" x 10-1/2" x 18"; (1) 36 Qt.; Double Pull-Out Waste/Recycling Units include two bins
- When lock option is specified, color will default based on leg finish:
 - Aged Bronze, Black, Galaxy, Shadow, and Storm: Black
 - Cloud: White
 - Burnish, Foil, and Satin Bronze: Satin Nickel
 - Chrome: Polished Nickel
- Credenzas include one adjustable shelf behind each door unless other components are specified
- Equipment racks hold 12RU and include a thermostatically controlled fan and plug strip



VENEER TOP WITH HARDWOOD EDGE

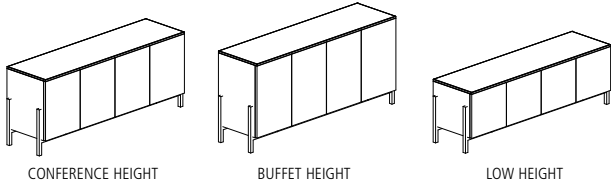

CASE MATERIAL KEY

PA-CB Painted Case with Cradle Base
 V-CB Veneer Case with Cradle Base

CRADLE BASE

MODEL #	W x D x H	DESCRIPTION	-PA-CB	-V-CB
CONFERENCE HEIGHT (24 IN. CASE WITH 6.5 IN. CRADLE BASE)				
FWLC-3629-W	36 x 20 x 30.5	Two Doors	5,867	6,148
FWLC-5429-W	54 x 20 x 30.5	Three Doors	7,336	7,703
FWLC-7229-W	72 x 20 x 30.5	Four Doors	8,807	9,260
FWLC-9029-W	90 x 20 x 30.5	Five Doors	10,277	10,815
FWLD-3629-W	36 x 24 x 30.5	Two Doors	6,352	6,662
FWLD-5429-W	54 x 24 x 30.5	Three Doors	7,970	8,377
FWLD-7229-W	72 x 24 x 30.5	Four Doors	9,584	10,087
FWLD-9029-W	90 x 24 x 30.5	Five Doors	11,203	11,793
BUFFET HEIGHT (29 IN. CASE WITH 6.5 IN. CRADLE BASE)				
FWCC-3636-W	36 x 20 x 35.5	Two Doors	6,256	6,559
FWCC-5436-W	54 x 20 x 35.5	Three Doors	7,841	8,242
FWCC-7236-W	72 x 20 x 35.5	Four Doors	9,430	9,922
FWCC-9036-W	90 x 20 x 35.5	Five Doors	11,017	11,599
FWCD-3636-W	36 x 24 x 35.5	Two Doors	6,780	7,114
FWCD-5436-W	54 x 24 x 35.5	Three Doors	8,526	8,965
FWCD-7236-W	72 x 24 x 35.5	Four Doors	10,271	10,812
FWCD-9036-W	90 x 24 x 35.5	Five Doors	12,021	12,659
LOW HEIGHT (18 IN. CASE WITH 6.5 IN. CRADLE BASE)				
FWWC-3624-W	36 x 20 x 24.5	Two Doors	5,468	5,729
FWWC-5424-W	54 x 20 x 24.5	Three Doors	6,818	7,156
FWWC-7224-W	72 x 20 x 24.5	Four Doors	8,165	8,582
FWWC-9024-W	90 x 20 x 24.5	Five Doors	9,516	10,010

DOOR STYLE

DESCRIPTION	CODE	NOTES	PRICE
Plank Veneer	-PWD	Available in Clear Coat Walnut	\$289
Vertical Veneer	-VD		No Charge
Horizontal Veneer	-HD		No Charge
Veneer/Paint Combination	-VPD	Reference page 8 for predetermined accent door locations	No Charge
Painted	-PAD		No Charge

OPTIONS	CODE	PRICE	NOTES
Locks	Add -LK	\$289	
Polished Chrome Base	Add -PCCB	\$1,632	
Equipment Rack Options - Buffet Height Credenzas:			
Fixed Equipment Rack	Add -R2	\$871	Available for 24" deep Credenzas, behind the left most pair of doors
Sliding Equipment Rack	Add -R1	\$3,174	Available for 24" deep Credenzas, behind the left most pair of doors
Waste/Recycling Unit Options:			
Single Pull-Out Waste/Recycling Unit	Add -TF1	\$283	Available for 20" deep Credenzas only (Wall-Hung excluded), behind right most doors
Double Pull-Out Waste/Recycling Unit	Add -TF2	\$438	Available for 24" depth credenzas only (Wall-Hung excluded), behind right most doors



VENEER TOP WITH HARDWOOD EDGE

REQUIRED INFORMATION (ORDER CANNOT BE ENTERED WITHOUT THIS INFORMATION):

See pages vi-vii for surface material options.

- Choose Door Style: Defaults to case finish, if none selected
- Choose Metal Finish
- Choose Wood Species & Finish
- Choose Paint Finish, if specified

GENERAL INFORMATION

- Tops are 3/4" -thick with 3/16" -deep hardwood edge band
- Plank veneer is hand selected walnut veneers of varying character and color, with a clear coat finish, to accentuate the plank appearance
- When Plank veneer door style is specified with a veneer case, case and top will default to clear coat walnut in standard slip-match layup
- When veneer case is specified, the case exterior is standard slip-match layup regardless of veneer door style selection
- Pull-Out Waste/Recycling Bin size: 14" x 10-1/2" x 18"; (1) 36 Qt.; Double Pull-Out Waste/Recycling Units include two bins
- When lock option is specified, color will default based on leg finish:
 - Aged Bronze, Black, Galaxy, Shadow, and Storm: Black
 - Cloud: White
 - Burnish, Foil, and Satin Bronze: Satin Nickel
 - Chrome: Polished Nickel
- Credenzas include one adjustable shelf behind each door unless other components are specified
- Equipment racks hold 12RU and include a thermostatically controlled fan and plug strip



VENEER TOP WITH HARDWOOD EDGE

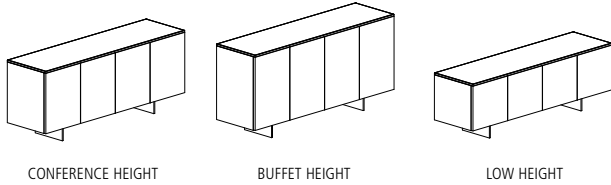

CASE MATERIAL KEY

PA-BB Painted Case with Blade Base
 V-BB Veneer Case with Blade Base

BLADE BASE

MODEL #	W x D x H	DESCRIPTION	-PA-BB	-V-BB
CONFERENCE HEIGHT (24 IN. CASE WITH 6.5 IN. BLADE BASE)				
FWLC-3629-W	36 x 20 x 30.5	Two Doors	5,581	5,865
FWLC-5429-W	54 x 20 x 30.5	Three Doors	7,050	7,418
FWLC-7229-W	72 x 20 x 30.5	Four Doors	8,519	8,976
FWLC-9029-W	90 x 20 x 30.5	Five Doors	9,991	10,529
FWLD-3629-W	36 x 24 x 30.5	Two Doors	6,068	6,378
FWLD-5429-W	54 x 24 x 30.5	Three Doors	7,683	8,090
FWLD-7229-W	72 x 24 x 30.5	Four Doors	9,300	9,802
FWLD-9029-W	90 x 24 x 30.5	Five Doors	10,917	11,510
BUFFET HEIGHT (29 IN. CASE WITH 6.5 IN. BLADE BASE)				
FWCC-3636-W	36 x 20 x 35.5	Two Doors	5,972	6,275
FWCC-5436-W	54 x 20 x 35.5	Three Doors	7,557	7,954
FWCC-7236-W	72 x 20 x 35.5	Four Doors	9,147	9,634
FWCC-9036-W	90 x 20 x 35.5	Five Doors	10,732	11,314
FWCD-3636-W	36 x 24 x 35.5	Two Doors	6,497	6,829
FWCD-5436-W	54 x 24 x 35.5	Three Doors	8,242	8,679
FWCD-7236-W	72 x 24 x 35.5	Four Doors	9,988	10,526
FWCD-9036-W	90 x 24 x 35.5	Five Doors	11,735	12,374
LOW HEIGHT (18 IN. CASE WITH 6.5 IN. BLADE BASE)				
FWWC-3624-W	36 x 20 x 24.5	Two Doors	5,185	5,443
FWWC-5424-W	54 x 20 x 24.5	Three Doors	6,535	6,872
FWWC-7224-W	72 x 20 x 24.5	Four Doors	7,881	8,297
FWWC-9024-W	90 x 20 x 24.5	Five Doors	9,230	9,723

DOOR STYLE

DESCRIPTION	CODE	NOTES	PRICE
Plank Veneer	-PWD	Available in Clear Coat Walnut	\$289
Vertical Veneer	-VD		No Charge
Horizontal Veneer	-HD		No Charge
Veneer/Paint Combination	-VPD	Reference page 8 for predetermined accent door locations	No Charge
Painted	-PAD		No Charge

OPTIONS

OPTIONS	CODE	PRICE	NOTES
Locks	Add -LK	\$289	
Polished Chrome Base	Add -PCBB	\$460	
Equipment Rack Options - Buffet Height Credenzas:			
Fixed Equipment Rack	Add -R2	\$871	Available for 24" deep Credenzas, behind the left most pair of doors
Sliding Equipment Rack	Add -R1	\$3,174	Available for 24" deep Credenzas, behind the left most pair of doors
Waste/Recycling Unit Options:			
Single Pull-Out Waste/Recycling Unit	Add -TF1	\$283	Available for 20" deep Credenzas only (Wall-Hung excluded), behind right most doors
Double Pull-Out Waste/Recycling Unit	Add -TF2	\$438	Available for 24" depth credenzas only (Wall-Hung excluded), behind right most doors



VENEER TOP WITH HARDWOOD EDGE

REQUIRED INFORMATION (ORDER CANNOT BE ENTERED WITHOUT THIS INFORMATION):

See pages vi-vii for surface material options.

- Choose Door Style: Defaults to case finish, if none selected
- Choose Metal Finish
- Choose Wood Species & Finish
- Choose Paint Finish, if specified

GENERAL INFORMATION

- Tops are 3/4" -thick with 3/16" -deep hardwood edge band
- Plank veneer is hand selected walnut veneers of varying character and color, with a clear coat finish, to accentuate the plank appearance
- When Plank veneer door style is specified with a veneer case, case and top will default to clear coat walnut in standard slip-match layup
- When veneer case is specified, the case exterior is standard slip-match layup regardless of veneer door style selection
- Pull-Out Waste/Recycling Bin size: 14" x 10-1/2" x 18"; (1) 36 Qt.; Double Pull-Out Waste/Recycling Units include two bins
- When lock option is specified, color will default based on leg finish:
 - Aged Bronze, Black, Galaxy, Shadow, and Storm: Black
 - Cloud: White
 - Burnish, Foil, and Satin Bronze: Satin Nickel
 - Chrome: Polished Nickel
- Credenzas include one adjustable shelf behind each door unless other components are specified
- Equipment racks hold 12RU and include a thermostatically controlled fan and plug strip



LAMINATE TOP WITH HARDWOOD EDGE

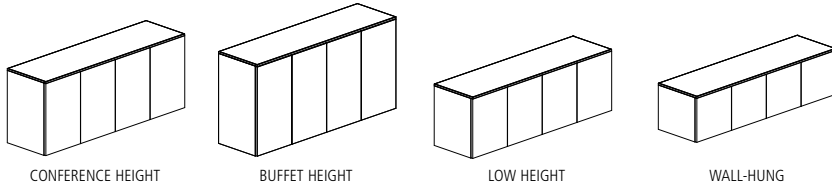

CASE MATERIAL KEY

PA Painted Case
V Veneer Case

CASE ONLY

MODEL #	W x D x H	DESCRIPTION	-PA	-V
CONFERENCE HEIGHT (29.5 INCH CASE)				
FWCC-3629-W-P	36 x 20 x 29.5	Two Doors	5,160	5,258
FWCC-5429-W-P	54 x 20 x 29.5	Three Doors	6,713	6,842
FWCC-7229-W-P	72 x 20 x 29.5	Four Doors	8,271	8,431
FWCC-9029-W-P	90 x 20 x 29.5	Five Doors	9,828	10,020
FWCD-3629-W-P	36 x 24 x 29.5	Two Doors	5,673	5,781
FWCD-5429-W-P	54 x 24 x 29.5	Three Doors	7,383	7,526
FWCD-7229-W-P	72 x 24 x 29.5	Four Doors	9,096	9,275
FWCD-9029-W-P	90 x 24 x 29.5	Five Doors	10,810	11,020
BUFFET HEIGHT (36.5 INCH CASE)				
FWBC-3636-W-P	36 x 20 x 36.5	Two Doors	5,930	6,044
FWBC-5436-W-P	54 x 20 x 36.5	Three Doors	7,718	7,866
FWBC-7236-W-P	72 x 20 x 36.5	Four Doors	9,510	9,692
FWBC-9036-W-P	90 x 20 x 36.5	Five Doors	11,299	11,520
FWBD-3636-W-P	36 x 24 x 36.5	Two Doors	6,521	6,648
FWBD-5436-W-P	54 x 24 x 36.5	Three Doors	8,488	8,653
FWBD-7236-W-P	72 x 24 x 36.5	Four Doors	10,459	10,661
FWBD-9036-W-P	90 x 24 x 36.5	Five Doors	12,431	12,671
LOW HEIGHT (24.5 INCH CASE)				
FWLC-3624-W-P	36 x 20 x 24.5	Two Doors	4,776	4,870
FWLC-5424-W-P	54 x 20 x 24.5	Three Doors	6,217	6,337
FWLC-7224-W-P	72 x 20 x 24.5	Four Doors	7,657	7,809
FWLC-9024-W-P	90 x 20 x 24.5	Five Doors	9,100	9,278
FWLD-3624-W-P	36 x 24 x 24.5	Two Doors	5,253	5,355
FWLD-5424-W-P	54 x 24 x 24.5	Three Doors	6,839	6,970
FWLD-7224-W-P	72 x 24 x 24.5	Four Doors	8,423	8,587
FWLD-9024-W-P	90 x 24 x 24.5	Five Doors	10,012	10,204
WALL-HUNG (18 INCH CASE)				
FWWC-3618-W-P	36 x 20 x 18	Two Doors	4,384	4,468
FWWC-5418-W-P	54 x 20 x 18	Three Doors	5,708	5,818
FWWC-7218-W-P	72 x 20 x 18	Four Doors	7,029	7,167
FWWC-9018-W-P	90 x 20 x 18	Five Doors	8,354	8,516

DOOR STYLE

DESCRIPTION	CODE	NOTES	PRICE
Vertical Veneer	-VD		No Charge
Horizontal Veneer	-HD		No Charge
Veneer/Paint Combination	-VPD	Reference page 8 for predetermined accent door locations	No Charge
Painted	-PAD		No Charge



LAMINATE TOP WITH HARDWOOD EDGE

OPTIONS	CODE	PRICE	NOTES
Locks	Add -LK	\$289	
Drawers Behind Doors (Buffet Height - 36" Case Only)	Add -D	\$564	
Equipment Rack Options - Conference Height and Buffet Height Credenzas:			
Fixed Equipment Rack	Add -R2	\$871	Available for 24" deep Credenzas, behind the left most pair of doors
Sliding Equipment Rack	Add -R1	\$3,174	Available for 24" deep Credenzas, behind the left most pair of doors
Waste/Recycling Unit Options:			
Single Pull-Out Waste/Recycling Unit	Add -TF1	\$283	Available for 20" deep Credenzas only (Wall-Hung excluded), behind right most doors
Double Pull-Out Waste/Recycling Unit	Add -TF2	\$438	Available for 24" depth credenzas only (Wall-Hung excluded), behind right most doors

REQUIRED INFORMATION (ORDER CANNOT BE ENTERED WITHOUT THIS INFORMATION):

See pages vi-vii for surface material options.

- Choose Door Style: Defaults to case finish, if none selected
- Choose Wood Species & Finish
- Choose Paint Finish, if specified
- Choose Laminate

GENERAL INFORMATION

- Tops are 3/4"-thick with 3/16"-deep hardwood edge band
- When veneer case is specified, the case exterior is standard slip-match layup regardless of veneer door style selection
- Pull-Out Waste/Recycling Bin size: 14" x 10-1/2" x 18"; (1) 36 Qt.; Double Pull-Out Waste/Recycling Units include two bins
- Locks
 - Veneer (Case Only) - When lock option is specified, color will default to Satin Nickel
 - Painted (Case Only) - When lock option is specified, color will default based on Paint finish:
 - Aged Bronze, Black, Galaxy, Shadow, and Storm: Black
 - Cloud: White
 - Burnish, Foil, Satin Bronze: Satin Nickel
 - Chrome: Polished Nickel
- Credenzas include one adjustable shelf behind each door unless other components are specified
- Equipment racks hold 12RU and include a thermostatically controlled fan and plug strip



LAMINATE TOP WITH HARDWOOD EDGE

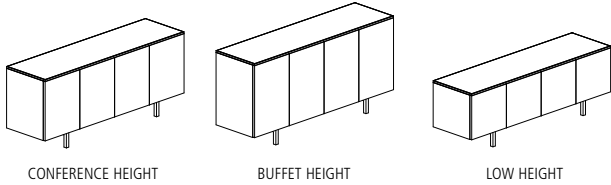

CASE MATERIAL KEY

PA-IB Painted Case with Inset Leg
 V-IB Veneer Case with Inset Leg

INSET LEG

MODEL #	W x D x H	DESCRIPTION	-PA-IB	-V-IB
CONFERENCE HEIGHT (24 IN. CASE WITH 6.5 IN. INSET LEG)				
FWLC-3629-W-P	36 x 20 x 30.5	Two Doors	5,204	5,299
FWLC-5429-W-P	54 x 20 x 30.5	Three Doors	6,644	6,766
FWLC-7229-W-P	72 x 20 x 30.5	Four Doors	8,085	8,236
FWLC-9029-W-P	90 x 20 x 30.5	Five Doors	9,530	9,706
FWLD-3629-W-P	36 x 24 x 30.5	Two Doors	5,681	5,781
FWLD-5429-W-P	54 x 24 x 30.5	Three Doors	7,267	7,397
FWLD-7229-W-P	72 x 24 x 30.5	Four Doors	8,852	9,015
FWLD-9029-W-P	90 x 24 x 30.5	Five Doors	10,438	10,633
BUFFET HEIGHT (29 IN. CASE WITH 6.5 IN. INSET LEG)				
FWCC-3636-W-P	36 x 20 x 35.5	Two Doors	5,585	5,685
FWCC-5436-W-P	54 x 20 x 35.5	Three Doors	7,141	7,271
FWCC-7236-W-P	72 x 20 x 35.5	Four Doors	8,697	8,860
FWCC-9036-W-P	90 x 20 x 35.5	Five Doors	10,255	10,447
FWCD-3636-W-P	36 x 24 x 35.5	Two Doors	6,101	6,211
FWCD-5436-W-P	54 x 24 x 35.5	Three Doors	7,813	7,953
FWCD-7236-W-P	72 x 24 x 35.5	Four Doors	9,525	9,699
FWCD-9036-W-P	90 x 24 x 35.5	Five Doors	11,239	11,448
LOW HEIGHT (18 IN. CASE WITH 6.5 IN. INSET LEG)				
FWWC-3624-W-P	36 x 20 x 24.5	Two Doors	4,813	4,898
FWWC-5424-W-P	54 x 20 x 24.5	Three Doors	6,139	6,246
FWWC-7224-W-P	72 x 20 x 24.5	Four Doors	7,459	7,593
FWWC-9024-W-P	90 x 20 x 24.5	Five Doors	8,783	8,946

DOOR STYLE

DESCRIPTION	CODE	NOTES	PRICE
Vertical Veneer	-VD		No Charge
Horizontal Veneer	-HD		No Charge
Veneer/Paint Combination	-VPD	Reference page 8 for predetermined accent door locations	No Charge
Painted	-PAD		No Charge

OPTIONS	CODE	PRICE	NOTES
Locks	Add -LK	\$289	
Polished Chrome Base	Add -PCIB	\$460	
Equipment Rack Options - Buffet Height Credenzas:			
Fixed Equipment Rack	Add -R2	\$871	Available for 24" deep Credenzas, behind the left most pair of doors
Sliding Equipment Rack	Add -R1	\$3,174	Available for 24" deep Credenzas, behind the left most pair of doors
Waste/Recycling Unit Options:			
Single Pull-Out Waste/Recycling Unit	Add -TF1	\$283	Available for 20" deep Credenzas only (Wall-Hung excluded), behind right most doors
Double Pull-Out Waste/Recycling Unit	Add -TF2	\$438	Available for 24" depth credenzas only (Wall-Hung excluded), behind right most doors



LAMINATE TOP WITH HARDWOOD EDGE

REQUIRED INFORMATION (ORDER CANNOT BE ENTERED WITHOUT THIS INFORMATION):

See pages vi-vii for surface material options.

- Choose Door Style: Defaults to case finish, if none selected
- Choose Metal Finish
- Choose Wood Species & Finish
- Choose Paint Finish, if specified
- Choose Laminate

GENERAL INFORMATION

- Tops are 3/4" -thick with 3/16" -deep hardwood edge band
- When veneer case is specified, the case exterior is standard slip-match layup regardless of veneer door style selection
- Pull-Out Waste/Recycling Bin size: 14" x 10-1/2" x 18"; (1) 36 Qt.; Double Pull-Out Waste/Recycling Units include two bins
- When lock option is specified, color will default based on leg finish:
 - Aged Bronze, Black, Galaxy, Shadow, and Storm: Black
 - Cloud: White
 - Burnish, Foil, and Satin Bronze: Satin Nickel
 - Chrome: Polished Nickel
- Credenzas include one adjustable shelf behind each door unless other components are specified
- Equipment racks hold 12RU and include a thermostatically controlled fan and plug strip



LAMINATE TOP WITH HARDWOOD EDGE

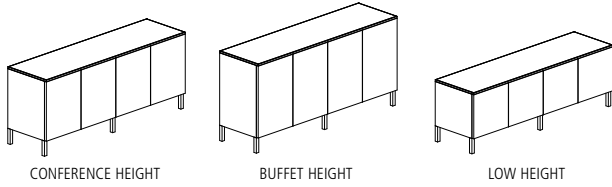

CASE MATERIAL KEY

PA-OB Painted Case with Edge-mount Post Leg
 V-OB Veneer Case with Edge-mount Post Leg

EDGE-MOUNT POST LEG

MODEL #	W x D x H	DESCRIPTION	-PA-OB	-V-OB
CONFERENCE HEIGHT (24 IN. CASE WITH 6.5 IN. EDGE-MOUNT POST LEG)				
FWLC-3629-W-P	36 x 20 x 30.5	Two Door	5,204	5,299
FWLC-5429-W-P	54 x 20 x 30.5	Three Door	6,644	6,766
FWLC-7229-W-P	72 x 20 x 30.5	Four Door	8,085	8,236
FWLC-9029-W-P	90 x 20 x 30.5	Five Door	9,530	9,706
FWLD-3629-W-P	36 x 24 x 30.5	Two Door	5,681	5,781
FWLD-5429-W-P	54 x 24 x 30.5	Three Door	7,267	7,397
FWLD-7229-W-P	72 x 24 x 30.5	Four Door	8,852	9,015
FWLD-9029-W-P	90 x 24 x 30.5	Five Door	10,438	10,633
BUFFET HEIGHT (29 IN. CASE WITH 6.5 IN. EDGE-MOUNT POST LEG)				
FWCC-3636-W-P	36 x 20 x 35.5	Two Door	5,585	5,685
FWCC-5436-W-P	54 x 20 x 35.5	Three Door	7,141	7,271
FWCC-7236-W-P	72 x 20 x 35.5	Four Door	8,697	8,860
FWCC-9036-W-P	90 x 20 x 35.5	Five Door	10,255	10,447
FWCD-3636-W-P	36 x 24 x 35.5	Two Door	6,101	6,211
FWCD-5436-W-P	54 x 24 x 35.5	Three Door	7,813	7,953
FWCD-7236-W-P	72 x 24 x 35.5	Four Door	9,525	9,699
FWCD-9036-W-P	90 x 24 x 35.5	Five Door	11,239	11,448
LOW HEIGHT (18 IN. CASE WITH 6.5 IN. EDGE-MOUNT POST LEG)				
FWWC-3624-W-P	36 x 20 x 24.5	Two Door	4,813	4,898
FWWC-5424-W-P	54 x 20 x 24.5	Three Door	6,139	6,246
FWWC-7224-W-P	72 x 20 x 24.5	Four Door	7,459	7,593
FWWC-9024-W-P	90 x 20 x 24.5	Five Door	8,783	8,946

DOOR STYLE

DESCRIPTION	CODE	NOTES	PRICE
Vertical Veneer	-VD		No Charge
Horizontal Veneer	-HD		No Charge
Veneer/Paint Combination	-VPD	Reference page 8 for predetermined accent door locations	No Charge
Painted	-PAD		No Charge

OPTIONS	CODE	PRICE	NOTES
Locks	Add -LK	\$289	
Polished Chrome Base	Add -PCOB	\$497	
Equipment Rack Options - Buffet Height Credenzas:			
Fixed Equipment Rack	Add -R2	\$871	Available for 24" deep Credenzas, behind the left most pair of doors
Sliding Equipment Rack	Add -R1	\$3,174	Available for 24" deep Credenzas, behind the left most pair of doors
Waste/Recycling Unit Options:			
Single Pull-Out Waste/Recycling Unit	Add -TF1	\$283	Available for 20" deep Credenzas only (Wall-Hung excluded), behind right most doors
Double Pull-Out Waste/Recycling Unit	Add -TF2	\$438	Available for 24" depth credenzas only (Wall-Hung excluded), behind right most doors



LAMINATE TOP WITH HARDWOOD EDGE

REQUIRED INFORMATION (ORDER CANNOT BE ENTERED WITHOUT THIS INFORMATION):

See pages vi-vii for surface material options.

- Choose Door Style: Defaults to case finish, if none selected
- Choose Metal Finish
- Choose Wood Species & Finish
- Choose Paint Finish, if specified
- Choose Laminate

GENERAL INFORMATION

- Tops are 3/4" -thick with 3/16" -deep hardwood edge band
- When veneer case is specified, the case exterior is standard slip-match layup regardless of veneer door style selection
- Pull-Out Waste/Recycling Bin size: 14" x 10-1/2" x 18"; (1) 36 Qt.; Double Pull-Out Waste/Recycling Units include two bins
- When lock option is specified, color will default based on leg finish:
 - Aged Bronze, Black, Galaxy, Shadow, and Storm: Black
 - Cloud: White
 - Burnish, Foil, and Satin Bronze: Satin Nickel
 - Chrome: Polished Nickel
- Credenzas include one adjustable shelf behind each door unless other components are specified
- Equipment racks hold 12RU and include a thermostatically controlled fan and plug strip



LAMINATE TOP WITH HARDWOOD EDGE

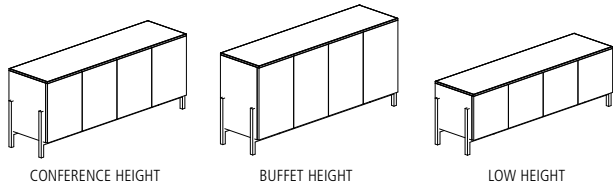

CASE MATERIAL KEY

PA-CB Painted Case with Cradle Base
 V-CB Veneer Case with Cradle Base

CRADLE BASE

MODEL #	W x D x H	DESCRIPTION	-PA-CB	-V-CB
CONFERENCE HEIGHT (24 IN. CASE WITH 6.5 IN. CRADLE BASE)				
FWLC-3629-W-P	36 x 20 x 30.5	Two Doors	5,773	5,868
FWLC-5429-W-P	54 x 20 x 30.5	Three Doors	7,215	7,335
FWLC-7229-W-P	72 x 20 x 30.5	Four Doors	8,656	8,808
FWLC-9029-W-P	90 x 20 x 30.5	Five Doors	10,099	10,277
FWLD-3629-W-P	36 x 24 x 30.5	Two Doors	6,251	6,352
FWLD-5429-W-P	54 x 24 x 30.5	Three Doors	7,837	7,969
FWLD-7229-W-P	72 x 24 x 30.5	Four Doors	9,424	9,584
FWLD-9029-W-P	90 x 24 x 30.5	Five Doors	11,007	11,203
BUFFET HEIGHT (29 IN. CASE WITH 6.5 IN. CRADLE BASE)				
FWCC-3636-W-P	36 x 20 x 35.5	Two Doors	6,155	6,256
FWCC-5436-W-P	54 x 20 x 35.5	Three Doors	7,713	7,840
FWCC-7236-W-P	72 x 20 x 35.5	Four Doors	9,268	9,430
FWCC-9036-W-P	90 x 20 x 35.5	Five Doors	10,828	11,017
FWCD-3636-W-P	36 x 24 x 35.5	Two Doors	6,673	6,780
FWCD-5436-W-P	54 x 24 x 35.5	Three Doors	8,385	8,525
FWCD-7236-W-P	72 x 24 x 35.5	Four Doors	10,096	10,270
FWCD-9036-W-P	90 x 24 x 35.5	Five Doors	11,809	12,021
LOW HEIGHT (18 IN. CASE WITH 6.5 IN. CRADLE BASE)				
FWWC-3624-W-P	36 x 20 x 24.5	Two Doors	5,382	5,467
FWWC-5424-W-P	54 x 20 x 24.5	Three Doors	6,709	6,816
FWWC-7224-W-P	72 x 20 x 24.5	Four Doors	8,029	8,164
FWWC-9024-W-P	90 x 20 x 24.5	Five Doors	9,354	9,515

DOOR STYLE

DESCRIPTION	CODE	NOTES	PRICE
Vertical Veneer	-VD		No Charge
Horizontal Veneer	-HD		No Charge
Veneer/Paint Combination	-VPD	Reference page 8 for predetermined accent door locations	No Charge
Painted	-PAD		No Charge

OPTIONS	CODE	PRICE	NOTES
Locks	Add -LK	\$289	
Polished Chrome Base	Add -PCCB	\$1,632	
Equipment Rack Options - Buffet Height Credenzas:			
Fixed Equipment Rack	Add -R2	\$871	Available for 24" deep Credenzas, behind the left most pair of doors
Sliding Equipment Rack	Add -R1	\$3,174	Available for 24" deep Credenzas, behind the left most pair of doors
Waste/Recycling Unit Options:			
Single Pull-Out Waste/Recycling Unit	Add -TF1	\$283	Available for 20" deep Credenzas only (Wall-Hung excluded), behind right most doors
Double Pull-Out Waste/Recycling Unit	Add -TF2	\$438	Available for 24" depth credenzas only (Wall-Hung excluded), behind right most doors



LAMINATE TOP WITH HARDWOOD EDGE

REQUIRED INFORMATION (ORDER CANNOT BE ENTERED WITHOUT THIS INFORMATION):

See pages vi-vii for surface material options.

- Choose Door Style: Defaults to case finish, if none selected
- Choose Metal Finish
- Choose Wood Species & Finish
- Choose Paint Finish, if specified
- Choose Laminate

GENERAL INFORMATION

- Tops are 3/4" -thick with 3/16" -deep hardwood edge band
- When veneer case is specified, the case exterior is standard slip-match layup regardless of veneer door style selection
- Pull-Out Waste/Recycling Bin size: 14" x 10-1/2" x 18"; (1) 36 Qt.; Double Pull-Out Waste/Recycling Units include two bins
- When lock option is specified, color will default based on leg finish:
 - Aged Bronze, Black, Galaxy, Shadow, and Storm: Black
 - Cloud: White
 - Burnish, Foil, and Satin Bronze: Satin Nickel
 - Chrome: Polished Nickel
- Credenzas include one adjustable shelf behind each door unless other components are specified
- Equipment racks hold 12RU and include a thermostatically controlled fan and plug strip



LAMINATE TOP WITH HARDWOOD EDGE

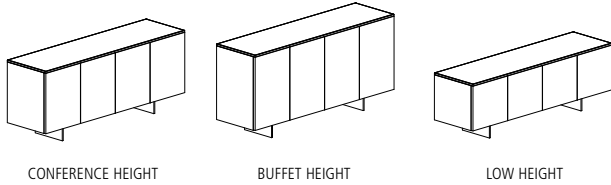

CASE MATERIAL KEY

PA-BB Painted Case with Blade Base
 V-BB Veneer Case with Blade Base

BLADE BASE

MODEL #	W x D x H	DESCRIPTION	-PA-BB	-V-BB
CONFERENCE HEIGHT (24 IN. CASE WITH 6.5 IN. BLADE LEG)				
FWLC-3629-W-P	36 x 20 x 30.5	Two Doors	5,489	5,582
FWLC-5429-W-P	54 x 20 x 30.5	Three Doors	6,927	7,049
FWLC-7229-W-P	72 x 20 x 30.5	Four Doors	8,371	8,521
FWLC-9029-W-P	90 x 20 x 30.5	Five Doors	9,813	9,991
FWLD-3629-W-P	36 x 24 x 30.5	Two Doors	5,964	6,068
FWLD-5429-W-P	54 x 24 x 30.5	Three Doors	7,546	7,682
FWLD-7229-W-P	72 x 24 x 30.5	Four Doors	9,134	9,300
FWLD-9029-W-P	90 x 24 x 30.5	Five Doors	10,721	10,917
BUFFET HEIGHT (29 IN. CASE WITH 6.5 IN. BLADE LEG)				
FWCC-3636-W-P	36 x 20 x 35.5	Two Doors	5,869	5,972
FWCC-5436-W-P	54 x 20 x 35.5	Three Doors	7,424	7,555
FWCC-7236-W-P	72 x 20 x 35.5	Four Doors	8,981	9,147
FWCC-9036-W-P	90 x 20 x 35.5	Five Doors	10,538	10,732
FWCD-3636-W-P	36 x 24 x 35.5	Two Doors	6,384	6,497
FWCD-5436-W-P	54 x 24 x 35.5	Three Doors	8,094	8,238
FWCD-7236-W-P	72 x 24 x 35.5	Four Doors	9,809	9,987
FWCD-9036-W-P	90 x 24 x 35.5	Five Doors	11,522	11,735
LOW HEIGHT (18 IN. CASE WITH 6.5 IN. BLADE LEG)				
FWWC-3624-W-P	36 x 20 x 24.5	Two Doors	5,096	5,183
FWWC-5424-W-P	54 x 20 x 24.5	Three Doors	6,420	6,533
FWWC-7224-W-P	72 x 20 x 24.5	Four Doors	7,742	7,879
FWWC-9024-W-P	90 x 20 x 24.5	Five Doors	9,065	9,229

DOOR STYLE

DESCRIPTION	CODE	NOTES	PRICE
Vertical Veneer	-VD		No Charge
Horizontal Veneer	-HD		No Charge
Veneer/Paint Combination	-VPD	Reference page 8 for predetermined accent door locations	No Charge
Painted	-PAD		No Charge

OPTIONS	CODE	PRICE	NOTES
Locks	Add -LK	\$289	
Polished Chrome Base	Add -PCBB	\$460	
Equipment Rack Options - Buffet Height Credenzas:			
Fixed Equipment Rack	Add -R2	\$871	Available for 24" deep Credenzas, behind the left most pair of doors
Sliding Equipment Rack	Add -R1	\$3,174	Available for 24" deep Credenzas, behind the left most pair of doors
Waste/Recycling Unit Options:			
Single Pull-Out Waste/Recycling Unit	Add -TF1	\$283	Available for 20" deep Credenzas only (Wall-Hung excluded), behind right most doors
Double Pull-Out Waste/Recycling Unit	Add -TF2	\$438	Available for 24" depth credenzas only (Wall-Hung excluded), behind right most doors



LAMINATE TOP WITH HARDWOOD EDGE

REQUIRED INFORMATION (ORDER CANNOT BE ENTERED WITHOUT THIS INFORMATION):

See pages vi-vii for surface material options.

- Choose Door Style: Defaults to case finish, if none selected
- Choose Metal Finish
- Choose Wood Species & Finish
- Choose Paint Finish, if specified
- Choose Laminate

GENERAL INFORMATION

- Tops are 3/4" -thick with 3/16" -deep hardwood edge band
- When veneer case is specified, the case exterior is standard slip-match layup regardless of veneer door style selection
- Pull-Out Waste/Recycling Bin size: 14" x 10-1/2" x 18"; (1) 36 Qt.; Double Pull-Out Waste/Recycling Units include two bins
- When lock option is specified, color will default based on leg finish:
 - Aged Bronze, Black, Galaxy, Shadow, and Storm: Black
 - Cloud: White
 - Burnish, Foil, and Satin Bronze: Satin Nickel
 - Chrome: Polished Nickel
- Credenzas include one adjustable shelf behind each door unless other components are specified
- Equipment racks hold 12RU and include a thermostatically controlled fan and plug strip



LAMINATE TOP WITH ABS EDGE

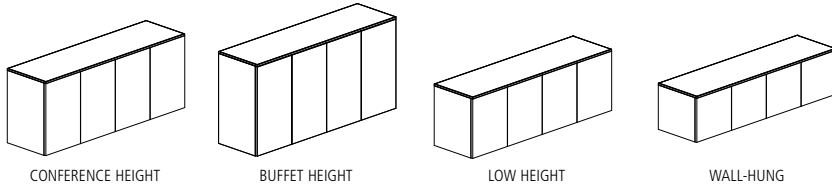

CASE MATERIAL KEY

PA Painted Case
 PEC Laminate Case

CASE ONLY

MODEL #	W x D x H	DESCRIPTION	-PA	-PEC
CONFERENCE HEIGHT (29.5 INCH CASE)				
FWCC-3629-PE	36 x 20 x 29.5	Two Doors	5,005	4,519
FWCC-5429-PE	54 x 20 x 29.5	Three Doors	6,517	5,880
FWCC-7229-PE	72 x 20 x 29.5	Four Doors	8,029	7,247
FWCC-9029-PE	90 x 20 x 29.5	Five Doors	9,542	8,611
FWCD-3629-PE	36 x 24 x 29.5	Two Doors	5,507	4,969
FWCD-5429-PE	54 x 24 x 29.5	Three Doors	7,169	6,471
FWCD-7229-PE	72 x 24 x 29.5	Four Doors	8,832	7,971
FWCD-9029-PE	90 x 24 x 29.5	Five Doors	10,496	9,473
BUFFET HEIGHT (36.5 INCH CASE)				
FWBC-3636-PE	36 x 20 x 36.5	Two Doors	5,755	5,194
FWBC-5436-PE	54 x 20 x 36.5	Three Doors	7,493	6,762
FWBC-7236-PE	72 x 20 x 36.5	Four Doors	9,232	8,332
FWBC-9036-PE	90 x 20 x 36.5	Five Doors	10,971	9,901
FWBD-3636-PE	36 x 24 x 36.5	Two Doors	6,335	5,717
FWBD-5436-PE	54 x 24 x 36.5	Three Doors	8,243	7,440
FWBD-7236-PE	72 x 24 x 36.5	Four Doors	10,155	9,166
FWBD-9036-PE	90 x 24 x 36.5	Five Doors	12,066	10,891
LOW HEIGHT (24.5 INCH CASE)				
FWLC-3624-PE	36 x 20 x 24.5	Two Doors	4,635	4,184
FWLC-5424-PE	54 x 20 x 24.5	Three Doors	6,033	5,446
FWLC-7224-PE	72 x 20 x 24.5	Four Doors	7,433	6,709
FWLC-9024-PE	90 x 20 x 24.5	Five Doors	8,833	7,972
FWLD-3624-PE	36 x 24 x 24.5	Two Doors	5,100	4,603
FWLD-5424-PE	54 x 24 x 24.5	Three Doors	6,639	5,991
FWLD-7224-PE	72 x 24 x 24.5	Four Doors	8,179	7,381
FWLD-9024-PE	90 x 24 x 24.5	Five Doors	9,718	8,772
WALL-HUNG (18 INCH CASE)				
FWWC-3618-PE	36 x 20 x 18	Two Doors	4,259	3,841
FWWC-5418-PE	54 x 20 x 18	Three Doors	5,544	5,003
FWWC-7218-PE	72 x 20 x 18	Four Doors	6,825	6,160
FWWC-9018-PE	90 x 20 x 18	Five Doors	8,112	7,321

DOOR STYLE

DESCRIPTION	CODE	NOTES	PRICE
Laminate	-PED	Woodgrain laminate will be vertical on door	No Charge
Painted	-PAD		No Charge



LAMINATE TOP WITH ABS EDGE

OPTIONS	CODE	PRICE	NOTES
Locks	Add -LK	\$289	
Drawers Behind Doors (Buffet Height - 36" Case Only)	Add -D	\$564	
Equipment Rack Options - Conference Height and Buffet Height Credenzas:			
Fixed Equipment Rack	Add -R2	\$871	Available for 24" deep Credenzas, behind the left most pair of doors
Sliding Equipment Rack	Add -R1	\$3,174	Available for 24" deep Credenzas, behind the left most pair of doors
Waste/Recycling Unit Options:			
Single Pull-Out Waste/Recycling Unit	Add -TF1	\$283	Available for 20" deep Credenzas only (Wall-Hung excluded), behind right most doors
Double Pull-Out Waste/Recycling Unit	Add -TF2	\$438	Available for 24" depth credenzas only (Wall-Hung excluded), behind right most doors

REQUIRED INFORMATION (ORDER CANNOT BE ENTERED WITHOUT THIS INFORMATION):

See pages vi-vii for surface material options.

- Choose Door Style: Defaults to case finish, if none selected
- Choose Paint Finish, if specified
- Choose Laminate
- Choose Edge Color: Defaults to matching edge band, if none selected

GENERAL INFORMATION

- Laminate Top with ABS Edge
 - Tops are 3/4" -thick with a 2 mm ABS edge
 - Solid and patterned laminates default to suggested solid color edge band
 - Wood grain laminates default to matching woodgrain edge band
- When veneer case is specified, the case exterior is standard slip-match layup regardless of veneer door style selection
- Pull-Out Waste/Recycling Bin Size: 14" x 10-1/2" x 18"; (1) 36 Qt.; Double Pull-Out Waste/Recycling Units include two bins
- Locks
 - Painted (Case Only) - When lock option is specified, color will default based on Paint finish:
 - Aged Bronze, Black, Galaxy, Shadow, and Storm: Black
 - Cloud: White
 - Burnish, Foil, Satin Bronze: Satin Nickel
 - Chrome: Polished Nickel
 - Woodgrain Laminate (Case Only) - When lock option is specified, color will default to Satin Nickel
 - Solid Laminate (Case Only) - When lock option is specified, color will default based on Laminate finish:
 - Brite White, Dover White, Pearl: White
 - Graystone, Folkstone: Satin Nickel
 - Graphite: Black
- Credenzas include one adjustable shelf behind each door unless other components are specified
- Equipment racks hold 12RU and include a thermostatically controlled fan and plug strip



LAMINATE TOP WITH ABS EDGE

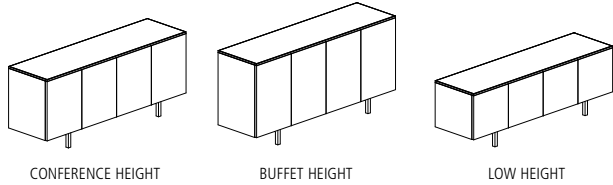

CASE MATERIAL KEY

PA-IB Painted Case with Inset Leg
 PEC-IB Laminate Case with Inset Leg

INSET LEG

MODEL #	W x D x H	DESCRIPTION	-PA-IB	-PEC-IB
CONFERENCE HEIGHT (24 IN. CASE WITH 6.5 IN. INSET LEG)				
FWLC-3629-PE	36 x 20 x 30.5	Two Doors	5,067	4,572
FWLC-5429-PE	54 x 20 x 30.5	Three Doors	6,464	5,834
FWLC-7229-PE	72 x 20 x 30.5	Four Doors	7,864	7,096
FWLC-9029-PE	90 x 20 x 30.5	Five Doors	9,262	8,359
FWLD-3629-PE	36 x 24 x 30.5	Two Doors	5,528	4,988
FWLD-5429-PE	54 x 24 x 30.5	Three Doors	7,067	6,379
FWLD-7229-PE	72 x 24 x 30.5	Four Doors	8,608	7,769
FWLD-9029-PE	90 x 24 x 30.5	Five Doors	10,145	9,158
BUFFET HEIGHT (29 IN. CASE WITH 6.5 IN. INSET LEG)				
FWCC-3636-PE	36 x 20 x 35.5	Two Doors	5,437	4,906
FWCC-5436-PE	54 x 20 x 35.5	Three Doors	6,945	6,266
FWCC-7236-PE	72 x 20 x 35.5	Four Doors	8,456	7,633
FWCC-9036-PE	90 x 20 x 35.5	Five Doors	9,969	8,996
FWCD-3636-PE	36 x 24 x 35.5	Two Doors	5,937	5,357
FWCD-5436-PE	54 x 24 x 35.5	Three Doors	7,598	6,857
FWCD-7236-PE	72 x 24 x 35.5	Four Doors	9,260	8,357
FWCD-9036-PE	90 x 24 x 35.5	Five Doors	10,924	9,858
LOW HEIGHT (18 IN. CASE WITH 6.5 IN. INSET LEG)				
FWWC-3624-PE	36 x 20 x 24.5	Two Doors	4,683	4,228
FWWC-5424-PE	54 x 20 x 24.5	Three Doors	5,972	5,389
FWWC-7224-PE	72 x 20 x 24.5	Four Doors	7,253	6,545
FWWC-9024-PE	90 x 20 x 24.5	Five Doors	8,539	7,704

DOOR STYLE

DESCRIPTION	CODE	NOTES	PRICE
Laminate	-PED	Woodgrain laminate will be vertical on door	No Charge
Painted	-PAD		No Charge

OPTIONS	CODE	PRICE	NOTES
Locks	Add -LK	\$289	
Polished Chrome Base	Add -PCIB	\$460	
Equipment Rack Options - Buffet Height Credenzas:			
Fixed Equipment Rack	Add -R2	\$871	Available for 24" deep Credenzas, behind the left most pair of doors
Sliding Equipment Rack	Add -R1	\$3,174	Available for 24" deep Credenzas, behind the left most pair of doors
Waste/Recycling Unit Options:			
Single Pull-Out Waste/Recycling Unit	Add -TF1	\$283	Available for 20" deep Credenzas only (Wall-Hung excluded), behind right most doors
Double Pull-Out Waste/Recycling Unit	Add -TF2	\$438	Available for 24" depth credenzas only (Wall-Hung excluded), behind right most doors



LAMINATE TOP WITH ABS EDGE

REQUIRED INFORMATION (ORDER CANNOT BE ENTERED WITHOUT THIS INFORMATION):

See pages vi-vii for surface material options.

- Choose Door Style: Defaults to case finish, if none selected
- Choose Metal Finish
- Choose Paint Finish, if specified
- Choose Laminate
- Choose Edge Color: Defaults to matching edge band, if none selected

GENERAL INFORMATION

- Laminate Top with ABS Edge
 - Tops are 3/4"-thick with a 2 mm ABS edge
 - Solid and patterned laminates default to suggested solid color edge band
 - Wood grain laminates default to matching woodgrain edge band
- When veneer case is specified, the case exterior is standard slip-match layup regardless of veneer door style selection
- Pull-Out Waste/Recycling Bin size: 14" x 10-1/2" x 18"; (1) 36 Qt.; Double Pull-Out Waste/Recycling Units include two bins
- When lock option is specified, color will default based on leg finish:
 - Aged Bronze, Black, Galaxy, Shadow, and Storm: Black
 - Cloud: White
 - Burnish, Foil, and Satin Bronze: Satin Nickel
 - Chrome: Polished Nickel
- Credenzas include one adjustable shelf behind each door unless other components are specified
- Equipment racks hold 12RU and include a thermostatically controlled fan and plug strip



LAMINATE TOP WITH ABS EDGE

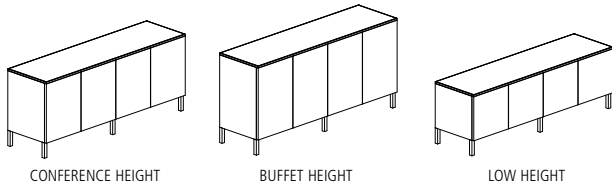

CASE MATERIAL KEY

PA-OB Painted Case with Edge-mount Post Leg
 PEC-OB Laminate Case with Edge-mount Post Leg

EDGE-MOUNT POST LEG

MODEL #	W x D x H	DESCRIPTION	-PA-OB	-PEC-OB
CONFERENCE HEIGHT (24 IN. CASE WITH 6.5 IN. EDGE-MOUNT POST LEG)				
FWLC-3629-PE	36 x 20 x 30.5	Two Door	5,067	4,572
FWLC-5429-PE	54 x 20 x 30.5	Three Door	6,464	5,834
FWLC-7229-PE	72 x 20 x 30.5	Four Door	7,864	7,096
FWLC-9029-PE	90 x 20 x 30.5	Five Door	9,262	8,359
FWLD-3629-PE	36 x 24 x 30.5	Two Door	5,528	4,988
FWLD-5429-PE	54 x 24 x 30.5	Three Door	7,067	6,379
FWLD-7229-PE	72 x 24 x 30.5	Four Door	8,608	7,769
FWLD-9029-PE	90 x 24 x 30.5	Five Door	10,145	9,158
BUFFET HEIGHT (29 IN. CASE WITH 6.5 IN. EDGE-MOUNT POST LEG)				
FWCC-3636-PE	36 x 20 x 35.5	Two Door	5,437	4,906
FWCC-5436-PE	54 x 20 x 35.5	Three Door	6,945	6,266
FWCC-7236-PE	72 x 20 x 35.5	Four Door	8,456	7,633
FWCC-9036-PE	90 x 20 x 35.5	Five Door	9,969	8,996
FWCD-3636-PE	36 x 24 x 35.5	Two Door	5,937	5,357
FWCD-5436-PE	54 x 24 x 35.5	Three Door	7,598	6,857
FWCD-7236-PE	72 x 24 x 35.5	Four Door	9,260	8,357
FWCD-9036-PE	90 x 24 x 35.5	Five Door	10,924	9,858
LOW HEIGHT (18 IN. CASE WITH 6.5 IN. EDGE-MOUNT POST LEG)				
FWWC-3624-PE	36 x 20 x 24.5	Two Door	4,683	4,228
FWWC-5424-PE	54 x 20 x 24.5	Three Door	5,972	5,389
FWWC-7224-PE	72 x 20 x 24.5	Four Door	7,253	6,545
FWWC-9024-PE	90 x 20 x 24.5	Five Door	8,539	7,704

DOOR STYLE

DESCRIPTION	CODE	NOTES	PRICE
Laminate	-PED	Woodgrain laminate will be vertical on door	No Charge
Painted	-PAD		No Charge

OPTIONS	CODE	PRICE	NOTES
Locks	Add -LK	\$289	
Polished Chrome Base	Add -PCOB	\$497	
Equipment Rack Options - Buffet Height Credenzas:			
Fixed Equipment Rack	Add -R2	\$871	Available for 24" deep Credenzas, behind the left most pair of doors
Sliding Equipment Rack	Add -R1	\$3,174	Available for 24" deep Credenzas, behind the left most pair of doors
Waste/Recycling Unit Options:			
Single Pull-Out Waste/Recycling Unit	Add -TF1	\$283	Available for 20" deep Credenzas only (Wall-Hung excluded), behind right most doors
Double Pull-Out Waste/Recycling Unit	Add -TF2	\$438	Available for 24" depth Credenzas only (Wall-Hung excluded), behind right most doors



LAMINATE TOP WITH ABS EDGE

REQUIRED INFORMATION (ORDER CANNOT BE ENTERED WITHOUT THIS INFORMATION):

See pages vi-vii for surface material options.

- Choose Door Style: Defaults to case finish, if none selected
- Choose Metal Finish
- Choose Paint Finish, if specified
- Choose Laminate
- Choose Edge Color: Defaults to matching edge band, if none selected

GENERAL INFORMATION

- Laminate Top with ABS Edge
 - Tops are 3/4"-thick with a 2 mm ABS edge
 - Solid and patterned laminates default to suggested solid color edge band
 - Wood grain laminates default to matching woodgrain edge band
- When veneer case is specified, the case exterior is standard slip-match layup regardless of veneer door style selection
- Pull-Out Waste/Recycling Bin size: 14" x 10-1/2" x 18"; (1) 36 Qt.; Double Pull-Out Waste/Recycling Units include two bins
- When lock option is specified, color will default based on leg finish:
 - Aged Bronze, Black, Galaxy, Shadow, and Storm: Black
 - Cloud: White
 - Burnish, Foil, and Satin Bronze: Satin Nickel
 - Chrome: Polished Nickel
- Credenzas include one adjustable shelf behind each door unless other components are specified
- Equipment racks hold 12RU and include a thermostatically controlled fan and plug strip



LAMINATE TOP WITH ABS EDGE

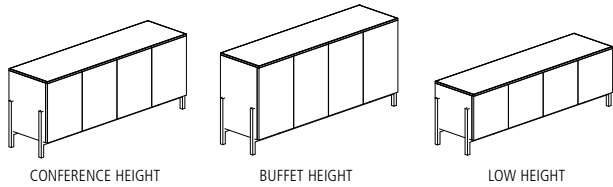

CASE MATERIAL KEY

PA-CB Painted Case with Cradle Base
 PEC-CB Laminate Case with Cradle Base

CRADLE BASE

MODEL #	W x D x H	DESCRIPTION	-PA-CB	-PEC-CB
CONFERENCE HEIGHT (24 IN. CASE WITH 6.5 IN. CRADLE BASE)				
FWLC-3629-PE	36 x 20 x 30.5	Two Doors	5,636	5,087
FWLC-5429-PE	54 x 20 x 30.5	Three Doors	7,033	6,348
FWLC-7229-PE	72 x 20 x 30.5	Four Doors	8,434	7,611
FWLC-9029-PE	90 x 20 x 30.5	Five Doors	9,834	8,875
FWLD-3629-PE	36 x 24 x 30.5	Two Doors	6,099	5,502
FWLD-5429-PE	54 x 24 x 30.5	Three Doors	7,637	6,894
FWLD-7229-PE	72 x 24 x 30.5	Four Doors	9,179	8,284
FWLD-9029-PE	90 x 24 x 30.5	Five Doors	10,717	9,673
BUFFET HEIGHT (29 IN. CASE WITH 6.5 IN. CRADLE BASE)				
FWCC-3636-PE	36 x 20 x 35.5	Two Doors	6,006	5,421
FWCC-5436-PE	54 x 20 x 35.5	Three Doors	7,515	6,783
FWCC-7236-PE	72 x 20 x 35.5	Four Doors	9,028	8,147
FWCC-9036-PE	90 x 20 x 35.5	Five Doors	10,538	9,511
FWCD-3636-PE	36 x 24 x 35.5	Two Doors	6,506	5,872
FWCD-5436-PE	54 x 24 x 35.5	Three Doors	8,166	7,370
FWCD-7236-PE	72 x 24 x 35.5	Four Doors	9,831	8,870
FWCD-9036-PE	90 x 24 x 35.5	Five Doors	11,494	10,372
LOW HEIGHT (18 IN. CASE WITH 6.5 IN. CRADLE BASE)				
FWWC-3624-PE	36 x 20 x 24.5	Two Doors	5,254	4,742
FWWC-5424-PE	54 x 20 x 24.5	Three Doors	6,540	5,905
FWWC-7224-PE	72 x 20 x 24.5	Four Doors	7,824	7,062
FWWC-9024-PE	90 x 20 x 24.5	Five Doors	9,108	8,220

DOOR STYLE

DESCRIPTION	CODE	NOTES	PRICE
Laminate	-PED	Woodgrain laminate will be vertical on door	No Charge
Painted	-PAD		No Charge

OPTIONS	CODE	PRICE	NOTES
Locks	Add -LK	\$289	
Polished Chrome Base	Add -PCCB	\$1,632	
Equipment Rack Options - Buffet Height Credenzas:			
Fixed Equipment Rack	Add -R2	\$871	Available for 24" deep Credenzas, behind the left most pair of doors
Sliding Equipment Rack	Add -R1	\$3,174	Available for 24" deep Credenzas, behind the left most pair of doors
Waste/Recycling Unit Options:			
Single Pull-Out Waste/Recycling Unit	Add -TF1	\$283	Available for 20" deep Credenzas only (Wall-Hung excluded), behind right most doors
Double Pull-Out Waste/Recycling Unit	Add -TF2	\$438	Available for 24" depth credenzas only (Wall-Hung excluded), behind right most doors



LAMINATE TOP WITH ABS EDGE

REQUIRED INFORMATION (ORDER CANNOT BE ENTERED WITHOUT THIS INFORMATION):

See pages vi-vii for surface material options.

- Choose Door Style: Defaults to case finish, if none selected
- Choose Metal Finish
- Choose Paint Finish, if specified
- Choose Laminate
- Choose Edge Color: Defaults to matching edge band, if none selected

GENERAL INFORMATION

- Laminate Top with ABS Edge
 - Tops are 3/4"-thick with a 2 mm ABS edge
 - Solid and patterned laminates default to suggested solid color edge band
 - Wood grain laminates default to matching woodgrain edge band
- When veneer case is specified, the case exterior is standard slip-match layup regardless of veneer door style selection
- Pull-Out Waste/Recycling Bin size: 14" x 10-1/2" x 18"; (1) 36 Qt.; Double Pull-Out Waste/Recycling Units include two bins
- When lock option is specified, color will default based on leg finish:
 - Aged Bronze, Black, Galaxy, Shadow, and Storm: Black
 - Cloud: White
 - Burnish, Foil, and Satin Bronze: Satin Nickel
 - Chrome: Polished Nickel
- Credenzas include one adjustable shelf behind each door unless other components are specified
- Equipment racks hold 12RU and include a thermostatically controlled fan and plug strip



LAMINATE TOP WITH ABS EDGE

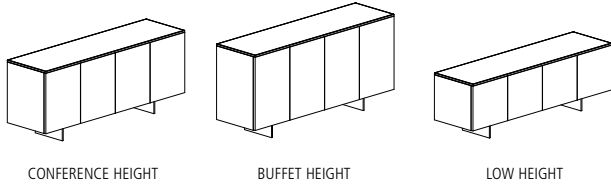

CASE MATERIAL KEY

PA-BB Painted Case with Blade Base
 PEC-BB Laminate Case with Blade Base

BLADE BASE

MODEL #	W x D x H	DESCRIPTION	-PA-BB	-PEC-BB
CONFERENCE HEIGHT (24 IN. CASE WITH 6.5 IN. BLADE LEG)				
FWLC-3629-PE	36 x 20 x 30.5	Two Doors	5,350	4,829
FWLC-5429-PE	54 x 20 x 30.5	Three Doors	6,747	6,090
FWLC-7229-PE	72 x 20 x 30.5	Four Doors	8,148	7,355
FWLC-9029-PE	90 x 20 x 30.5	Five Doors	9,550	8,618
FWLD-3629-PE	36 x 24 x 30.5	Two Doors	5,814	5,245
FWLD-5429-PE	54 x 24 x 30.5	Three Doors	7,352	6,635
FWLD-7229-PE	72 x 24 x 30.5	Four Doors	8,893	8,025
FWLD-9029-PE	90 x 24 x 30.5	Five Doors	10,432	9,414
BUFFET HEIGHT (29 IN. CASE WITH 6.5 IN. BLADE LEG)				
FWCC-3636-PE	36 x 20 x 35.5	Two Doors	5,720	5,164
FWCC-5436-PE	54 x 20 x 35.5	Three Doors	7,230	6,523
FWCC-7236-PE	72 x 20 x 35.5	Four Doors	8,741	7,890
FWCC-9036-PE	90 x 20 x 35.5	Five Doors	10,253	9,253
FWCD-3636-PE	36 x 24 x 35.5	Two Doors	6,220	5,614
FWCD-5436-PE	54 x 24 x 35.5	Three Doors	7,884	7,114
FWCD-7236-PE	72 x 24 x 35.5	Four Doors	9,547	8,614
FWCD-9036-PE	90 x 24 x 35.5	Five Doors	11,208	10,114
LOW HEIGHT (18 IN. CASE WITH 6.5 IN. BLADE LEG)				
FWWC-3624-PE	36 x 20 x 24.5	Two Doors	4,969	4,486
FWWC-5424-PE	54 x 20 x 24.5	Three Doors	6,256	5,645
FWWC-7224-PE	72 x 20 x 24.5	Four Doors	7,540	6,806
FWWC-9024-PE	90 x 20 x 24.5	Five Doors	8,822	7,962

DOOR STYLE

DESCRIPTION	CODE	NOTES	PRICE
Laminate	-PED	Woodgrain laminate will be vertical on door	No Charge
Painted	-PAD		No Charge

OPTIONS	CODE	PRICE	NOTES
Locks	Add -LK	\$289	
Polished Chrome Base	Add -PCBB	\$460	
Equipment Rack Options - Buffet Height Credenzas:			
Fixed Equipment Rack	Add -R2	\$871	Available for 24" deep Credenzas, behind the left most pair of doors
Sliding Equipment Rack	Add -R1	\$3,174	Available for 24" deep Credenzas, behind the left most pair of doors
Waste/Recycling Unit Options:			
Single Pull-Out Waste/Recycling Unit	Add -TF1	\$283	Available for 20" deep Credenzas only (Wall-Hung excluded), behind right most doors
Double Pull-Out Waste/Recycling Unit	Add -TF2	\$438	Available for 24" depth credenzas only (Wall-Hung excluded), behind right most doors



LAMINATE TOP WITH ABS EDGE

REQUIRED INFORMATION (ORDER CANNOT BE ENTERED WITHOUT THIS INFORMATION):

See pages vi-vii for surface material options.

- Choose Door Style: Defaults to case finish, if none selected
- Choose Metal Finish
- Choose Paint Finish, if specified
- Choose Laminate
- Choose Edge Color: Defaults to matching edge band, if none selected

GENERAL INFORMATION

- Laminate Top with ABS Edge
 - Tops are 3/4"-thick with a 2 mm ABS edge
 - Solid and patterned laminates default to suggested solid color edge band
 - Wood grain laminates default to matching woodgrain edge band
- When veneer case is specified, the case exterior is standard slip-match layup regardless of veneer door style selection
- Pull-Out Waste/Recycling Bin size: 14" x 10-1/2" x 18"; (1) 36 Qt.; Double Pull-Out Waste/Recycling Units include two bins
- When lock option is specified, color will default based on leg finish:
 - Aged Bronze, Black, Galaxy, Shadow, and Storm: Black
 - Cloud: White
 - Burnish, Foil, and Satin Bronze: Satin Nickel
 - Chrome: Polished Nickel
- Credenzas include one adjustable shelf behind each door unless other components are specified
- Equipment racks hold 12RU and include a thermostatically controlled fan and plug strip



GLOSS GLASS TOP

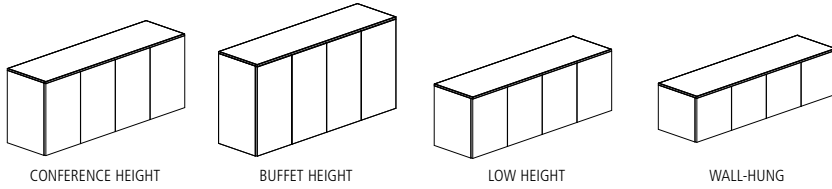

CASE MATERIAL KEY

PA Painted Case
V Veneer Case

CASE ONLY

MODEL #	W x D x H	DESCRIPTION	-PA	-V
CONFERENCE HEIGHT (29 INCH CASE)				
FWCC-3629-GG	36 x 20 x 29	Two Doors	5,756	6,397
FWCC-5429-GG	54 x 20 x 29	Three Doors	7,494	8,326
FWCC-7229-GG	72 x 20 x 29	Four Doors	9,233	10,257
FWCC-9029-GG	90 x 20 x 29	Five Doors	10,972	12,189
FWCD-3629-GG	36 x 24 x 29	Two Doors	6,335	7,034
FWCD-5429-GG	54 x 24 x 29	Three Doors	8,245	9,158
FWCD-7229-GG	72 x 24 x 29	Four Doors	10,156	11,283
FWCD-9029-GG	90 x 24 x 29	Five Doors	12,069	13,406
BUFFET HEIGHT (36 INCH CASE)				
FWBC-3636-GG	36 x 20 x 36	Two Doors	6,620	7,352
FWBC-5436-GG	54 x 20 x 36	Three Doors	8,617	9,571
FWBC-7236-GG	72 x 20 x 36	Four Doors	10,618	11,792
FWBC-9036-GG	90 x 20 x 36	Five Doors	12,617	14,015
FWBD-3636-GG	36 x 24 x 36	Two Doors	7,281	8,088
FWBD-5436-GG	54 x 24 x 36	Three Doors	9,479	10,527
FWBD-7236-GG	72 x 24 x 36	Four Doors	11,677	12,971
FWBD-9036-GG	90 x 24 x 36	Five Doors	13,876	15,419
LOW HEIGHT (24 INCH CASE)				
FWLC-3624-GG	36 x 20 x 24	Two Doors	5,332	5,925
FWLC-5424-GG	54 x 20 x 24	Three Doors	6,937	7,712
FWLC-7224-GG	72 x 20 x 24	Four Doors	8,551	9,497
FWLC-9024-GG	90 x 20 x 24	Five Doors	10,160	11,288
FWLD-3624-GG	36 x 24 x 24	Two Doors	5,865	6,515
FWLD-5424-GG	54 x 24 x 24	Three Doors	7,635	8,481
FWLD-7224-GG	72 x 24 x 24	Four Doors	9,404	10,448
FWLD-9024-GG	90 x 24 x 24	Five Doors	11,175	12,414
WALL-HUNG (17.5 INCH CASE)				
FWWC-3618-GG	36 x 20 x 17.5	Two Doors	4,897	5,439
FWWC-5418-GG	54 x 20 x 17.5	Three Doors	6,374	7,076
FWWC-7218-GG	72 x 20 x 17.5	Four Doors	7,849	8,720
FWWC-9018-GG	90 x 20 x 17.5	Five Doors	9,327	10,363

DOOR STYLE

DESCRIPTION	CODE	NOTES	PRICE
Plank Veneer	-PWD	Available in Clear Coat Walnut	\$289
Vertical Veneer	-VD		No Charge
Horizontal Veneer	-HD	Reference page 8 for predetermined accent door locations	No Charge
Veneer/Paint Combination	-VPD		No Charge
Painted	-PAD		No Charge



GLOSS GLASS TOP

OPTIONS	CODE	PRICE	NOTES
Locks	Add -LK	\$289	
Drawers Behind Doors (Buffet Height - 36" Case Only)	Add -D	\$564	
Equipment Rack Options - Conference Height and Buffet Height Credenzas:			
Fixed Equipment Rack	Add -R2	\$871	Available for 24" deep Credenzas, behind the left most pair of doors
Sliding Equipment Rack	Add -R1	\$3,174	Available for 24" deep Credenzas, behind the left most pair of doors
Waste/Recycling Unit Options:			
Single Pull-Out Waste/Recycling Unit	Add -TF1	\$283	Available for 20" deep Credenzas only (Wall-Hung excluded), behind right most doors
Double Pull-Out Waste/Recycling Unit	Add -TF2	\$438	Available for 24" depth credenzas only (Wall-Hung excluded), behind right most doors

REQUIRED INFORMATION (ORDER CANNOT BE ENTERED WITHOUT THIS INFORMATION):

See pages vi-vii for surface material options.

- Choose Door Style: Defaults to case finish, if none selected
- Choose Glass Finish
- Choose Paint Finish, if specified
- Choose Wood Species & Finish, if specified

GENERAL INFORMATION

- Glass is 1/4" -thick back-painted, low-iron glass
- Plank veneer is hand selected walnut veneers of varying character and color, with a clear coat finish, to accentuate the plank appearance
- When Plank veneer door style is specified with a veneer case, case and top will default to clear coat walnut in standard slip-match layup
- When veneer case is specified, the case exterior is standard slip-match layup regardless of veneer door style selection
- Pull-Out Waste/Recycling Bin size: 14" x 10-1/2" x 18"; (1) 36 Qt.; Double Pull-Out Waste/Recycling Units include two bins
- Locks
 - Veneer (Case Only) - When lock option is specified, color will default to Satin Nickel
 - Painted (Case Only) - When lock option is specified, color will default based on Paint finish:
 - Aged Bronze, Black, Galaxy, Shadow, and Storm: Black
 - Cloud: White
 - Burnish, Foil, Satin Bronze: Satin Nickel
 - Chrome: Polished Nickel
- Credenzas include one adjustable shelf behind each door unless other components are specified
- Equipment racks hold 12RU and include a thermostatically controlled fan and plug strip



GLOSS GLASS TOP

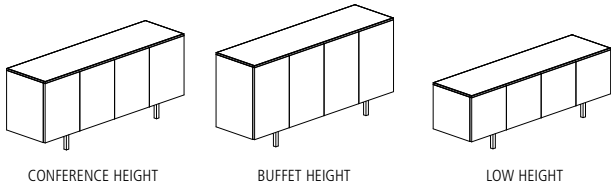

CASE MATERIAL KEY

PA-IB Painted Case with Inset Leg
 V-IB Veneer Case with Inset Leg

INSET LEG

MODEL #	W x D x H	DESCRIPTION	-PA-IB	-V-IB
CONFERENCE HEIGHT (23.5 IN. CASE WITH 6.5 IN. INSET LEG)				
FWLC-3629-GG	36 x 20 x 30	Two Doors	5,759	6,351
FWLC-5429-GG	54 x 20 x 30	Three Doors	7,367	8,140
FWLC-7229-GG	72 x 20 x 30	Four Doors	8,978	9,927
FWLC-9029-GG	90 x 20 x 30	Five Doors	10,589	11,716
FWLD-3629-GG	36 x 24 x 30	Two Doors	6,290	6,939
FWLD-5429-GG	54 x 24 x 30	Three Doors	8,062	8,909
FWLD-7229-GG	72 x 24 x 30	Four Doors	9,833	10,876
FWLD-9029-GG	90 x 24 x 30	Five Doors	11,602	12,840
BUFFET HEIGHT (28.5 IN. CASE WITH 6.5 IN. INSET LEG)				
FWCC-3636-GG	36 x 20 x 35	Two Doors	6,186	6,822
FWCC-5436-GG	54 x 20 x 35	Three Doors	7,923	8,756
FWCC-7236-GG	72 x 20 x 35	Four Doors	9,662	10,688
FWCC-9036-GG	90 x 20 x 35	Five Doors	11,399	12,617
FWCD-3636-GG	36 x 24 x 35	Two Doors	6,761	7,462
FWCD-5436-GG	54 x 24 x 35	Three Doors	8,673	9,584
FWCD-7236-GG	72 x 24 x 35	Four Doors	10,585	11,711
FWCD-9036-GG	90 x 24 x 35	Five Doors	12,498	13,835
LOW HEIGHT (17.5 IN. CASE WITH 6.5 IN. INSET LEG)				
FWWC-3624-GG	36 x 20 x 24	Two Doors	5,323	5,866
FWWC-5424-GG	54 x 20 x 24	Three Doors	6,801	7,506
FWWC-7224-GG	72 x 20 x 24	Four Doors	8,278	9,149
FWWC-9024-GG	90 x 20 x 24	Five Doors	9,755	10,791

DOOR STYLE

DESCRIPTION	CODE	NOTES	PRICE
Plank Veneer	-PWD	Available in Clear Coat Walnut	\$289
Vertical Veneer	-VD		No Charge
Horizontal Veneer	-HD		No Charge
Veneer/Paint Combination	-VPD	Reference page 8 for predetermined accent door locations	No Charge
Painted	-PAD		No Charge

OPTIONS

	CODE	PRICE	NOTES
Locks	Add -LK	\$289	
Polished Chrome Base	Add -PCIB	\$460	
Equipment Rack Options - Buffet Height Credenzas:			
Fixed Equipment Rack	Add -R2	\$871	Available for 24" deep Credenzas, behind the left most pair of doors
Sliding Equipment Rack	Add -R1	\$3,174	Available for 24" deep Credenzas, behind the left most pair of doors
Waste/Recycling Unit Options:			
Single Pull-Out Waste/Recycling Unit	Add -TF1	\$283	Available for 20" deep Credenzas only (Wall-Hung excluded), behind right most doors
Double Pull-Out Waste/Recycling Unit	Add -TF2	\$438	Available for 24" depth credenzas only (Wall-Hung excluded), behind right most doors



GLOSS GLASS TOP

REQUIRED INFORMATION (ORDER CANNOT BE ENTERED WITHOUT THIS INFORMATION):

See pages vi-vii for surface material options.

- Choose Door Style: Defaults to case finish, if none selected
- Choose Metal Finish
- Choose Glass Finish
- Choose Paint Finish, if specified
- Choose Wood Species & Finish, if specified

GENERAL INFORMATION

- Glass is 1/4" -thick back-painted, low-iron glass
- Plank veneer is hand selected walnut veneers of varying character and color, with a clear coat finish, to accentuate the plank appearance
- When Plank veneer door style is specified with a veneer case, case and top will default to clear coat walnut in standard slip-match layup
- When veneer case is specified, the case exterior is standard slip-match layup regardless of veneer door style selection
- Pull-Out Waste/Recycling Bin size: 14" x 10-1/2" x 18"; (1) 36 Qt.; Double Pull-Out Waste/Recycling Units include two bins
- When lock option is specified, color will default based on leg finish:
 - Aged Bronze, Black, Galaxy, Shadow, and Storm: Black
 - Cloud: White
 - Burnish, Foil, and Satin Bronze: Satin Nickel
 - Chrome: Polished Nickel
- Credenzas include one adjustable shelf behind each door unless other components are specified
- Equipment racks hold 12RU and include a thermostatically controlled fan and plug strip



GLOSS GLASS TOP

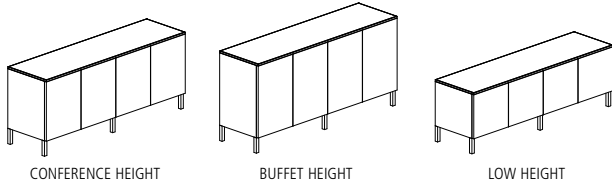

CASE MATERIAL KEY

PA-OB Painted Case with Edge-mount Post Leg
 V-OB Veneer Case with Edge-mount Post Leg

EDGE-MOUNT POST LEG

MODEL #	W x D x H	DESCRIPTION	-PA-OB	-V-OB
CONFERENCE HEIGHT (23.5 IN. CASE WITH 6.5 IN. EDGE-MOUNT POST LEG)				
FWLC-3629-GG	36 x 20 x 30	Two Door	5,759	6,351
FWLC-5429-GG	54 x 20 x 30	Three Door	7,367	8,140
FWLC-7229-GG	72 x 20 x 30	Four Door	8,978	9,927
FWLC-9029-GG	90 x 20 x 30	Five Door	10,589	11,716
FWLD-3629-GG	36 x 24 x 30	Two Door	6,290	6,939
FWLD-5429-GG	54 x 24 x 30	Three Door	8,062	8,909
FWLD-7229-GG	72 x 24 x 30	Four Door	9,833	10,876
FWLD-9029-GG	90 x 24 x 30	Five Door	11,602	12,840
BUFFET HEIGHT (28.5 IN. CASE WITH 6.5 IN. EDGE-MOUNT POST LEG)				
FWCC-3636-GG	36 x 20 x 35	Two Door	6,186	6,822
FWCC-5436-GG	54 x 20 x 35	Three Door	7,923	8,756
FWCC-7236-GG	72 x 20 x 35	Four Door	9,662	10,688
FWCC-9036-GG	90 x 20 x 35	Five Door	11,399	12,617
FWCD-3636-GG	36 x 24 x 35	Two Door	6,761	7,462
FWCD-5436-GG	54 x 24 x 35	Three Door	8,673	9,584
FWCD-7236-GG	72 x 24 x 35	Four Door	10,585	11,711
FWCD-9036-GG	90 x 24 x 35	Five Door	12,498	13,835
LOW HEIGHT (17.5 IN. CASE WITH 6.5 IN. EDGE-MOUNT POST LEG)				
FWWC-3624-GG	36 x 20 x 24	Two Door	5,323	5,866
FWWC-5424-GG	54 x 20 x 24	Three Door	6,801	7,506
FWWC-7224-GG	72 x 20 x 24	Four Door	8,278	9,149
FWWC-9024-GG	90 x 20 x 24	Five Door	9,755	10,791

DOOR STYLE

DESCRIPTION	CODE	NOTES	PRICE
Plank Veneer	-PWD	Available in Clear Coat Walnut	\$289
Vertical Veneer	-VD		No Charge
Horizontal Veneer	-HD		No Charge
Veneer/Paint Combination	-VPD	Reference page 8 for predetermined accent door locations	No Charge
Painted	-PAD		No Charge

OPTIONS

	CODE	PRICE	NOTES
Locks	Add -LK	\$289	
Polished Chrome Base	Add -PCOB	\$497	
Equipment Rack Options - Buffet Height Credenzas:			
Fixed Equipment Rack	Add -R2	\$871	Available for 24" deep Credenzas, behind the left most pair of doors
Sliding Equipment Rack	Add -R1	\$3,174	Available for 24" deep Credenzas, behind the left most pair of doors
Waste/Recycling Unit Options:			
Single Pull-Out Waste/Recycling Unit	Add -TF1	\$283	Available for 20" deep Credenzas only (Wall-Hung excluded), behind right most doors
Double Pull-Out Waste/Recycling Unit	Add -TF2	\$438	Available for 24" depth credenzas only (Wall-Hung excluded), behind right most doors



GLOSS GLASS TOP

REQUIRED INFORMATION (ORDER CANNOT BE ENTERED WITHOUT THIS INFORMATION):

See pages vi-vii for surface material options.

- Choose Door Style: Defaults to case finish, if none selected
- Choose Metal Finish
- Choose Glass Finish
- Choose Paint Finish, if specified
- Choose Wood Species & Finish, if specified

GENERAL INFORMATION

- Glass is 1/4" -thick back-painted, low-iron glass
- Plank veneer is hand selected walnut veneers of varying character and color, with a clear coat finish, to accentuate the plank appearance
- When Plank veneer door style is specified with a veneer case, case and top will default to clear coat walnut in standard slip-match layup
- When veneer case is specified, the case exterior is standard slip-match layup regardless of veneer door style selection
- Pull-Out Waste/Recycling Bin size: 14" x 10-1/2" x 18"; (1) 36 Qt.; Double Pull-Out Waste/Recycling Units include two bins
- When lock option is specified, color will default based on leg finish:
 - Aged Bronze, Black, Galaxy, Shadow, and Storm: Black
 - Cloud: White
 - Burnish, Foil, and Satin Bronze: Satin Nickel
 - Chrome: Polished Nickel
- Credenzas include one adjustable shelf behind each door unless other components are specified
- Equipment racks hold 12RU and include a thermostatically controlled fan and plug strip



GLOSS GLASS TOP

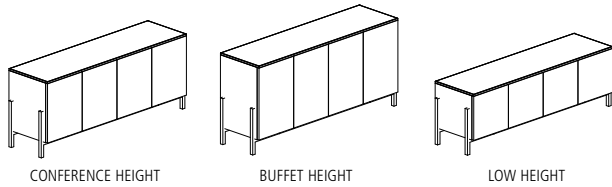

CASE MATERIAL KEY

PA-CB Painted Case with Cradle Base
 V-CB Veneer Case with Cradle Base

CRADLE BASE

MODEL #	W x D x H	DESCRIPTION	-PA-CB	-V-CB
CONFERENCE HEIGHT (23.5 IN. CASE WITH 6.5 IN. CRADLE BASE)				
FWLC-3629-GG	36 x 20 x 30	Two Doors	6,331	6,922
FWLC-5429-GG	54 x 20 x 30	Three Doors	7,938	8,708
FWLC-7229-GG	72 x 20 x 30	Four Doors	9,550	10,498
FWLC-9029-GG	90 x 20 x 30	Five Doors	11,159	12,286
FWLD-3629-GG	36 x 24 x 30	Two Doors	6,865	7,513
FWLD-5429-GG	54 x 24 x 30	Three Doors	8,631	9,479
FWLD-7229-GG	72 x 24 x 30	Four Doors	10,401	11,447
FWLD-9029-GG	90 x 24 x 30	Five Doors	12,173	13,413
BUFFET HEIGHT (28.5 IN. CASE WITH 6.5 IN. CRADLE BASE)				
FWCC-3636-GG	36 x 20 x 35	Two Doors	6,757	7,394
FWCC-5436-GG	54 x 20 x 35	Three Doors	8,493	9,325
FWCC-7236-GG	72 x 20 x 35	Four Doors	10,230	11,257
FWCC-9036-GG	90 x 20 x 35	Five Doors	11,969	13,188
FWCD-3636-GG	36 x 24 x 35	Two Doors	7,331	8,032
FWCD-5436-GG	54 x 24 x 35	Three Doors	9,242	10,156
FWCD-7236-GG	72 x 24 x 35	Four Doors	11,154	12,281
FWCD-9036-GG	90 x 24 x 35	Five Doors	13,067	14,405
LOW HEIGHT (17.5 IN. CASE WITH 6.5 IN. CRADLE BASE)				
FWWC-3624-GG	36 x 20 x 24	Two Doors	5,893	6,436
FWWC-5424-GG	54 x 20 x 24	Three Doors	7,375	8,076
FWWC-7224-GG	72 x 20 x 24	Four Doors	8,847	9,718
FWWC-9024-GG	90 x 20 x 24	Five Doors	10,326	11,362

DOOR STYLE

DESCRIPTION	CODE	NOTES	PRICE
Plank Veneer	-PWD	Available in Clear Coat Walnut	\$289
Vertical Veneer	-VD		No Charge
Horizontal Veneer	-HD		No Charge
Veneer/Paint Combination	-VPD	Reference page 8 for predetermined accent door locations	No Charge
Painted	-PAD		No Charge

OPTIONS

	CODE	PRICE	NOTES
Locks	Add -LK	\$289	
Polished Chrome Base	Add -PCCB	\$1,632	
Equipment Rack Options - Buffet Height Credenzas:			
Fixed Equipment Rack	Add -R2	\$871	Available for 24" deep Credenzas, behind the left most pair of doors
Sliding Equipment Rack	Add -R1	\$3,174	Available for 24" deep Credenzas, behind the left most pair of doors
Waste/Recycling Unit Options:			
Single Pull-Out Waste/Recycling Unit	Add -TF1	\$283	Available for 20" deep Credenzas only (Wall-Hung excluded), behind right most doors
Double Pull-Out Waste/Recycling Unit	Add -TF2	\$438	Available for 24" depth credenzas only (Wall-Hung excluded), behind right most doors



GLOSS GLASS TOP

REQUIRED INFORMATION (ORDER CANNOT BE ENTERED WITHOUT THIS INFORMATION):

See pages vi-vii for surface material options.

- Choose Door Style: Defaults to case finish, if none selected
- Choose Metal Finish
- Choose Glass Finish
- Choose Paint Finish, if specified
- Choose Wood Species & Finish, if specified

GENERAL INFORMATION

- Glass is 1/4" -thick back-painted, low-iron glass
- Plank veneer is hand selected walnut veneers of varying character and color, with a clear coat finish, to accentuate the plank appearance
- When Plank veneer door style is specified with a veneer case, case and top will default to clear coat walnut in standard slip-match layup
- When veneer case is specified, the case exterior is standard slip-match layup regardless of veneer door style selection
- Pull-Out Waste/Recycling Bin size: 14" x 10-1/2" x 18"; (1) 36 Qt.; Double Pull-Out Waste/Recycling Units include two bins
- When lock option is specified, color will default based on leg finish:
 - Aged Bronze, Black, Galaxy, Shadow, and Storm: Black
 - Cloud: White
 - Burnish, Foil, and Satin Bronze: Satin Nickel
 - Chrome: Polished Nickel
- Credenzas include one adjustable shelf behind each door unless other components are specified
- Equipment racks hold 12RU and include a thermostatically controlled fan and plug strip



GLOSS GLASS TOP

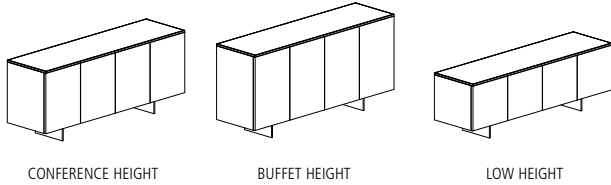

CASE MATERIAL KEY

PA-BB Painted Case with Blade Base
 V-BB Veneer Case with Blade Base

BLADE BASE

MODEL #	W x D x H	DESCRIPTION	-PA-BB	-V-BB
CONFERENCE HEIGHT (23.5 IN. CASE WITH 6.5 IN. BLADE LEG)				
FWLC-3629-GG	36 x 20 x 30	Two Doors	6,044	6,636
FWLC-5429-GG	54 x 20 x 30	Three Doors	7,653	8,422
FWLC-7229-GG	72 x 20 x 30	Four Doors	9,262	10,212
FWLC-9029-GG	90 x 20 x 30	Five Doors	10,874	12,001
FWLD-3629-GG	36 x 24 x 30	Two Doors	6,578	7,226
FWLD-5429-GG	54 x 24 x 30	Three Doors	8,346	9,191
FWLD-7229-GG	72 x 24 x 30	Four Doors	10,117	11,161
FWLD-9029-GG	90 x 24 x 30	Five Doors	11,888	13,126
BUFFET HEIGHT (28.5 IN. CASE WITH 6.5 IN. BLADE LEG)				
FWCC-3636-GG	36 x 20 x 35	Two Doors	6,473	7,109
FWCC-5436-GG	54 x 20 x 35	Three Doors	8,208	9,041
FWCC-7236-GG	72 x 20 x 35	Four Doors	9,947	10,971
FWCC-9036-GG	90 x 20 x 35	Five Doors	11,684	12,902
FWCD-3636-GG	36 x 24 x 35	Two Doors	7,047	7,749
FWCD-5436-GG	54 x 24 x 35	Three Doors	8,956	9,871
FWCD-7236-GG	72 x 24 x 35	Four Doors	10,868	11,996
FWCD-9036-GG	90 x 24 x 35	Five Doors	12,781	14,121
LOW HEIGHT (17.5 IN. CASE WITH 6.5 IN. BLADE LEG)				
FWWC-3624-GG	36 x 20 x 24	Two Doors	4,897	6,149
FWWC-5424-GG	54 x 20 x 24	Three Doors	6,374	7,791
FWWC-7224-GG	72 x 20 x 24	Four Doors	7,849	9,434
FWWC-9024-GG	90 x 20 x 24	Five Doors	9,327	11,074

DOOR STYLE

DESCRIPTION	CODE	NOTES	PRICE
Plank Veneer	-PWD	Available in Clear Coat Walnut	\$289
Vertical Veneer	-VD		No Charge
Horizontal Veneer	-HD		No Charge
Veneer/Paint Combination	-VPD	Reference page 8 for predetermined accent door locations	No Charge
Painted	-PAD		No Charge

OPTIONS

OPTIONS	CODE	PRICE	NOTES
Locks	Add -LK	\$289	
Polished Chrome Base	Add -PCBB	\$460	
Equipment Rack Options - Buffet Height Credenzas:			
Fixed Equipment Rack	Add -R2	\$871	Available for 24" deep Credenzas, behind the left most pair of doors
Sliding Equipment Rack	Add -R1	\$3,174	Available for 24" deep Credenzas, behind the left most pair of doors
Waste/Recycling Unit Options:			
Single Pull-Out Waste/Recycling Unit	Add -TF1	\$283	Available for 20" deep Credenzas only (Wall-Hung excluded), behind right most doors
Double Pull-Out Waste/Recycling Unit	Add -TF2	\$438	Available for 24" depth credenzas only (Wall-Hung excluded), behind right most doors



GLOSS GLASS TOP

REQUIRED INFORMATION (ORDER CANNOT BE ENTERED WITHOUT THIS INFORMATION):

See pages vi-vii for surface material options.

- Choose Door Style: Defaults to case finish, if none selected
- Choose Metal Finish
- Choose Glass Finish
- Choose Paint Finish, if specified
- Choose Wood Species & Finish, if specified

GENERAL INFORMATION

- Glass is 1/4" -thick back-painted, low-iron glass
- Plank veneer is hand selected walnut veneers of varying character and color, with a clear coat finish, to accentuate the plank appearance
- When Plank veneer door style is specified with a veneer case, case and top will default to clear coat walnut in standard slip-match layup
- When veneer case is specified, the case exterior is standard slip-match layup regardless of veneer door style selection
- Pull-Out Waste/Recycling Bin size: 14" x 10-1/2" x 18"; (1) 36 Qt.; Double Pull-Out Waste/Recycling Units include two bins
- When lock option is specified, color will default based on leg finish:
 - Aged Bronze, Black, Galaxy, Shadow, and Storm: Black
 - Cloud: White
 - Burnish, Foil, and Satin Bronze: Satin Nickel
 - Chrome: Polished Nickel
- Credenzas include one adjustable shelf behind each door unless other components are specified
- Equipment racks hold 12RU and include a thermostatically controlled fan and plug strip



SATIN GLASS TOP

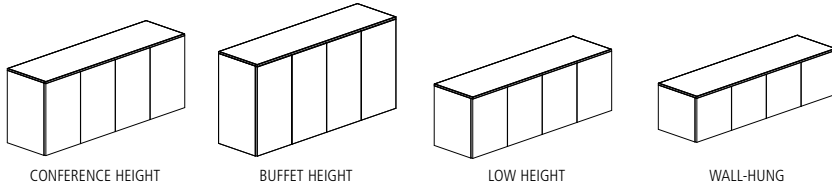

CASE MATERIAL KEY

PA Painted Case
V Veneer Case

CASE ONLY

MODEL #	W x D x H	DESCRIPTION	-PA	-V
CONFERENCE HEIGHT (29 INCH CASE)				
FWCC-3629-SG	36 x 20 x 29	Two Doors	6,057	6,715
FWCC-5429-SG	54 x 20 x 29	Three Doors	7,886	8,741
FWCC-7229-SG	72 x 20 x 29	Four Doors	9,716	10,770
FWCC-9029-SG	90 x 20 x 29	Five Doors	11,545	12,798
FWCD-3629-SG	36 x 24 x 29	Two Doors	6,662	7,386
FWCD-5429-SG	54 x 24 x 29	Three Doors	8,675	9,616
FWCD-7229-SG	72 x 24 x 29	Four Doors	10,689	11,848
FWCD-9029-SG	90 x 24 x 29	Five Doors	12,698	14,076
BUFFET HEIGHT (36 INCH CASE)				
FWBC-3636-SG	36 x 20 x 36	Two Doors	6,966	7,720
FWBC-5436-SG	54 x 20 x 36	Three Doors	9,067	10,049
FWBC-7236-SG	72 x 20 x 36	Four Doors	11,169	12,383
FWBC-9036-SG	90 x 20 x 36	Five Doors	13,275	14,716
FWBD-3636-SG	36 x 24 x 36	Two Doors	7,661	8,491
FWBD-5436-SG	54 x 24 x 36	Three Doors	9,971	11,055
FWBD-7236-SG	72 x 24 x 36	Four Doors	12,288	13,620
FWBD-9036-SG	90 x 24 x 36	Five Doors	14,601	16,189
LOW HEIGHT (24 INCH CASE)				
FWLC-3624-SG	36 x 20 x 24	Two Doors	5,610	6,219
FWLC-5424-SG	54 x 20 x 24	Three Doors	7,302	8,095
FWLC-7224-SG	72 x 20 x 24	Four Doors	8,995	9,971
FWLC-9024-SG	90 x 20 x 24	Five Doors	10,691	11,852
FWLD-3624-SG	36 x 24 x 24	Two Doors	6,169	6,840
FWLD-5424-SG	54 x 24 x 24	Three Doors	8,031	8,903
FWLD-7224-SG	72 x 24 x 24	Four Doors	9,894	10,971
FWLD-9024-SG	90 x 24 x 24	Five Doors	11,758	13,036
WALL-HUNG (17.5 INCH CASE)				
FWWC-3618-SG	36 x 20 x 17.5	Two Doors	5,151	5,707
FWWC-5418-SG	54 x 20 x 17.5	Three Doors	6,708	7,433
FWWC-7218-SG	72 x 20 x 17.5	Four Doors	8,259	9,650
FWWC-9018-SG	90 x 20 x 17.5	Five Doors	9,815	10,880

DOOR STYLE

DESCRIPTION	CODE	NOTES	PRICE
Plank Veneer	-PWD	Available in Clear Coat Walnut	\$289
Vertical Veneer	-VD		No Charge
Horizontal Veneer	-HD		No Charge
Veneer/Paint Combination	-VPD	Reference page 8 for predetermined accent door locations	No Charge
Painted	-PAD		No Charge



SATIN GLASS TOP

OPTIONS	CODE	PRICE	NOTES
Locks	Add -LK	\$289	
Drawers Behind Doors (Buffet Height - 36" Case Only)	Add -D	\$564	
Equipment Rack Options - Conference Height and Buffet Height Credenzas:			
Fixed Equipment Rack	Add -R2	\$871	Available for 24" deep Credenzas, behind the left most pair of doors
Sliding Equipment Rack	Add -R1	\$3,174	Available for 24" deep Credenzas, behind the left most pair of doors
Waste/Recycling Unit Options:			
Single Pull-Out Waste/Recycling Unit	Add -TF1	\$283	Available for 20" deep Credenzas only (Wall-Hung excluded), behind right most doors
Double Pull-Out Waste/Recycling Unit	Add -TF2	\$438	Available for 24" depth credenzas only (Wall-Hung excluded), behind right most doors

REQUIRED INFORMATION (ORDER CANNOT BE ENTERED WITHOUT THIS INFORMATION):

See pages vi-vii for surface material options.

- Choose Door Style: Defaults to case finish, if none selected
- Choose Glass Finish
- Choose Paint Finish, if specified
- Choose Wood Species & Finish, if specified

GENERAL INFORMATION

- Glass is 1/4" -thick back-painted, low-iron glass
- Plank veneer is hand selected walnut veneers of varying character and color, with a clear coat finish, to accentuate the plank appearance
- When Plank veneer door style is specified with a veneer case, case and top will default to clear coat walnut in standard slip-match layup
- When veneer case is specified, the case exterior is standard slip-match layup regardless of veneer door style selection
- Pull-Out Waste/Recycling Bin size: 14" x 10-1/2" x 18"; (1) 36 Qt.; Double Pull-Out Waste/Recycling Units include two bins
- Locks
 - Veneer (Case Only) - When lock option is specified, color will default to Satin Nickel
 - Painted (Case Only) - When lock option is specified, color will default based on Paint finish:
 - Aged Bronze, Black, Galaxy, Shadow, and Storm: Black
 - Cloud: White
 - Burnish, Foil, Satin Bronze: Satin Nickel
 - Chrome: Polished Nickel
- Credenzas include one adjustable shelf behind each door unless other components are specified
- Equipment racks hold 12RU and include a thermostatically controlled fan and plug strip



SATIN GLASS TOP

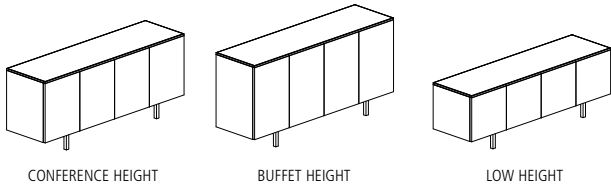

CASE MATERIAL KEY

PA-IB Painted Case with Inset Leg
 V-IB Veneer Case with Inset Leg

INSET LEG

MODEL #	W x D x H	DESCRIPTION	-PA-IB	-V-IB
CONFERENCE HEIGHT (23.5 IN. CASE WITH 6.5 IN. INSET LEG)				
FWLC-3629-SG	36 x 20 x 30	Two Doors	6,037	6,646
FWLC-5429-SG	54 x 20 x 30	Three Doors	7,729	8,521
FWLC-7229-SG	72 x 20 x 30	Four Doors	9,422	10,398
FWLC-9029-SG	90 x 20 x 30	Five Doors	11,116	12,278
FWLD-3629-SG	36 x 24 x 30	Two Doors	6,600	7,268
FWLD-5429-SG	54 x 24 x 30	Three Doors	8,458	9,330
FWLD-7229-SG	72 x 24 x 30	Four Doors	10,323	11,398
FWLD-9029-SG	90 x 24 x 30	Five Doors	12,186	13,463
BUFFET HEIGHT (28.5 IN. CASE WITH 6.5 IN. INSET LEG)				
FWCC-3636-SG	36 x 20 x 35	Two Doors	6,486	7,144
FWCC-5436-SG	54 x 20 x 35	Three Doors	8,312	9,170
FWCC-7236-SG	72 x 20 x 35	Four Doors	10,143	11,198
FWCC-9036-SG	90 x 20 x 35	Five Doors	11,972	13,226
FWCD-3636-SG	36 x 24 x 35	Two Doors	7,091	7,814
FWCD-5436-SG	54 x 24 x 35	Three Doors	9,101	10,045
FWCD-7236-SG	72 x 24 x 35	Four Doors	11,115	12,275
FWCD-9036-SG	90 x 24 x 35	Five Doors	13,126	14,504
LOW HEIGHT (17.5 IN. CASE WITH 6.5 IN. INSET LEG)				
FWWC-3624-SG	36 x 20 x 24	Two Doors	5,579	6,136
FWWC-5424-SG	54 x 20 x 24	Three Doors	7,135	7,859
FWWC-7224-SG	72 x 20 x 24	Four Doors	8,688	10,078
FWWC-9024-SG	90 x 20 x 24	Five Doors	10,241	11,307

DOOR STYLE

DESCRIPTION	CODE	NOTES	PRICE
Plank Veneer	-PWD	Available in Clear Coat Walnut	\$289
Vertical Veneer	-VD		No Charge
Horizontal Veneer	-HD		No Charge
Veneer/Paint Combination	-VPD	Reference page 8 for predetermined accent door locations	No Charge
Painted	-PAD		No Charge

OPTIONS

	CODE	PRICE	NOTES
Locks	Add -LK	\$289	
Polished Chrome Base	Add -PCIB	\$460	
Equipment Rack Options - Buffet Height Credenzas:			
Fixed Equipment Rack	Add -R2	\$871	Available for 24" deep Credenzas, behind the left most pair of doors
Sliding Equipment Rack	Add -R1	\$3,174	Available for 24" deep Credenzas, behind the left most pair of doors
Waste/Recycling Unit Options:			
Single Pull-Out Waste/Recycling Unit	Add -TF1	\$283	Available for 20" deep Credenzas only (Wall-Hung excluded), behind right most doors
Double Pull-Out Waste/Recycling Unit	Add -TF2	\$438	Available for 24" deep credenzas only (Wall-Hung excluded), behind right most doors



SATIN GLASS TOP

REQUIRED INFORMATION (ORDER CANNOT BE ENTERED WITHOUT THIS INFORMATION):

See pages vi-vii for surface material options.

- Choose Door Style: Defaults to case finish, if none selected
- Choose Metal Finish
- Choose Glass Finish
- Choose Paint Finish, if specified
- Choose Wood Species & Finish, if specified

GENERAL INFORMATION

- Glass is 1/4" -thick back-painted, low-iron glass
- Plank veneer is hand selected walnut veneers of varying character and color, with a clear coat finish, to accentuate the plank appearance
- When Plank veneer door style is specified with a veneer case, case and top will default to clear coat walnut in standard slip-match layup
- When veneer case is specified, the case exterior is standard slip-match layup regardless of veneer door style selection
- Pull-Out Waste/Recycling Bin size: 14" x 10-1/2" x 18"; (1) 36 Qt.; Double Pull-Out Waste/Recycling Units include two bins
- When lock option is specified, color will default based on leg finish:
 - Aged Bronze, Black, Galaxy, Shadow, and Storm: Black
 - Cloud: White
 - Burnish, Foil, and Satin Bronze: Satin Nickel
 - Chrome: Polished Nickel
- Credenzas include one adjustable shelf behind each door unless other components are specified
- Equipment racks hold 12RU and include a thermostatically controlled fan and plug strip



SATIN GLASS TOP

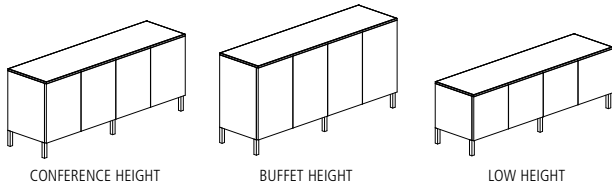

CASE MATERIAL KEY

PA-OB Painted Case with Edge-mount Post Leg
 V-OB Veneer Case with Edge-mount Post Leg

EDGE-MOUNT POST LEG

MODEL #	W x D x H	DESCRIPTION	-PA-OB	-V-OB
CONFERENCE HEIGHT (23.5 IN. CASE WITH 6.5 IN. EDGE-MOUNT POST LEG)				
FWLC-3629-SG	36 x 20 x 30	Two Door	6,037	6,646
FWLC-5429-SG	54 x 20 x 30	Three Door	7,729	8,521
FWLC-7229-SG	72 x 20 x 30	Four Door	9,422	10,398
FWLC-9029-SG	90 x 20 x 30	Five Door	11,116	12,278
FWLD-3629-SG	36 x 24 x 30	Two Door	6,600	7,268
FWLD-5429-SG	54 x 24 x 30	Three Door	8,458	9,330
FWLD-7229-SG	72 x 24 x 30	Four Door	10,323	11,398
FWLD-9029-SG	90 x 24 x 30	Five Door	12,186	13,463
BUFFET HEIGHT (28.5 IN. CASE WITH 6.5 IN. EDGE-MOUNT POST LEG)				
FWCC-3636-SG	36 x 20 x 35	Two Door	6,486	7,144
FWCC-5436-SG	54 x 20 x 35	Three Door	8,312	9,170
FWCC-7236-SG	72 x 20 x 35	Four Door	10,143	11,198
FWCC-9036-SG	90 x 20 x 35	Five Door	11,972	13,226
FWCD-3636-SG	36 x 24 x 35	Two Door	7,091	7,814
FWCD-5436-SG	54 x 24 x 35	Three Door	9,101	10,045
FWCD-7236-SG	72 x 24 x 35	Four Door	11,115	12,275
FWCD-9036-SG	90 x 24 x 35	Five Door	13,126	14,504
LOW HEIGHT (17.5 IN. CASE WITH 6.5 IN. EDGE-MOUNT POST LEG)				
FWWC-3624-SG	36 x 20 x 24	Two Door	5,579	6,136
FWWC-5424-SG	54 x 20 x 24	Three Door	7,135	7,859
FWWC-7224-SG	72 x 20 x 24	Four Door	8,688	10,078
FWWC-9024-SG	90 x 20 x 24	Five Door	10,241	11,307

DOOR STYLE

DESCRIPTION	CODE	NOTES	PRICE
Plank Veneer	-PWD	Available in Clear Coat Walnut	\$289
Vertical Veneer	-VD		No Charge
Horizontal Veneer	-HD		No Charge
Veneer/Paint Combination	-VPD	Reference page 8 for predetermined accent door locations	No Charge
Painted	-PAD		No Charge

OPTIONS

	CODE	PRICE	NOTES
Locks	Add -LK	\$289	
Polished Chrome Base	Add -PCOB	\$497	
Equipment Rack Options - Buffet Height Credenzas:			
Fixed Equipment Rack	Add -R2	\$871	Available for 24" deep Credenzas, behind the left most pair of doors
Sliding Equipment Rack	Add -R1	\$3,174	Available for 24" deep Credenzas, behind the left most pair of doors
Waste/Recycling Unit Options:			
Single Pull-Out Waste/Recycling Unit	Add -TF1	\$283	Available for 20" deep Credenzas only (Wall-Hung excluded), behind right most doors
Double Pull-Out Waste/Recycling Unit	Add -TF2	\$438	Available for 24" depth credenzas only (Wall-Hung excluded), behind right most doors



SATIN GLASS TOP

REQUIRED INFORMATION (ORDER CANNOT BE ENTERED WITHOUT THIS INFORMATION):

See pages vi-vii for surface material options.

- Choose Door Style: Defaults to case finish, if none selected
- Choose Metal Finish
- Choose Glass Finish
- Choose Paint Finish, if specified
- Choose Wood Species & Finish, if specified

GENERAL INFORMATION

- Glass is 1/4" -thick back-painted, low-iron glass
- Plank veneer is hand selected walnut veneers of varying character and color, with a clear coat finish, to accentuate the plank appearance
- When Plank veneer door style is specified with a veneer case, case and top will default to clear coat walnut in standard slip-match layup
- When veneer case is specified, the case exterior is standard slip-match layup regardless of veneer door style selection
- Pull-Out Waste/Recycling Bin size: 14" x 10-1/2" x 18"; (1) 36 Qt.; Double Pull-Out Waste/Recycling Units include two bins
- When lock option is specified, color will default based on leg finish:
 - Aged Bronze, Black, Galaxy, Shadow, and Storm: Black
 - Cloud: White
 - Burnish, Foil, and Satin Bronze: Satin Nickel
 - Chrome: Polished Nickel
- Credenzas include one adjustable shelf behind each door unless other components are specified
- Equipment racks hold 12RU and include a thermostatically controlled fan and plug strip



SATIN GLASS TOP

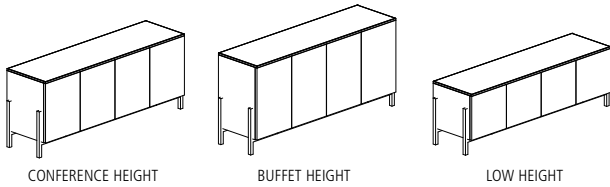

CASE MATERIAL KEY

PA-CB Painted Case with Cradle Base
 V-CB Veneer Case with Cradle Base

CRADLE BASE

MODEL #	W x D x H	DESCRIPTION	-PA-CB	-V-CB
CONFERENCE HEIGHT (23.5 IN. CASE WITH 6.5 IN. CRADLE BASE)				
FWLC-3629-SG	36 x 20 x 30	Two Doors	6,609	7,218
FWLC-5429-SG	54 x 20 x 30	Three Doors	8,298	9,091
FWLC-7229-SG	72 x 20 x 30	Four Doors	9,991	10,969
FWLC-9029-SG	90 x 20 x 30	Five Doors	11,688	12,847
FWLD-3629-SG	36 x 24 x 30	Two Doors	7,169	7,838
FWLD-5429-SG	54 x 24 x 30	Three Doors	9,030	9,903
FWLD-7229-SG	72 x 24 x 30	Four Doors	10,894	11,968
FWLD-9029-SG	90 x 24 x 30	Five Doors	12,758	14,036
BUFFET HEIGHT (28.5 IN. CASE WITH 6.5 IN. CRADLE BASE)				
FWCC-3636-SG	36 x 20 x 35	Two Doors	7,055	7,715
FWCC-5436-SG	54 x 20 x 35	Three Doors	8,884	9,741
FWCC-7236-SG	72 x 20 x 35	Four Doors	10,715	11,768
FWCC-9036-SG	90 x 20 x 35	Five Doors	12,543	13,798
FWCD-3636-SG	36 x 24 x 35	Two Doors	7,661	8,386
FWCD-5436-SG	54 x 24 x 35	Three Doors	9,671	10,614
FWCD-7236-SG	72 x 24 x 35	Four Doors	11,684	12,845
FWCD-9036-SG	90 x 24 x 35	Five Doors	13,698	15,078
LOW HEIGHT (17.5 IN. CASE WITH 6.5 IN. CRADLE BASE)				
FWWC-3624-SG	36 x 20 x 24	Two Doors	6,148	6,708
FWWC-5424-SG	54 x 20 x 24	Three Doors	7,703	8,429
FWWC-7224-SG	72 x 20 x 24	Four Doors	9,258	10,648
FWWC-9024-SG	90 x 20 x 24	Five Doors	10,812	11,878

DOOR STYLE

DESCRIPTION	CODE	NOTES	PRICE
Plank Veneer	-PWD	Available in Clear Coat Walnut	\$289
Vertical Veneer	-VD		No Charge
Horizontal Veneer	-HD		No Charge
Veneer/Paint Combination	-VPD	Reference page 8 for predetermined accent door locations	No Charge
Painted	-PAD		No Charge

OPTIONS	CODE	PRICE	NOTES
Locks	Add -LK	\$289	
Polished Chrome Base	Add -PCCB	\$1,632	
Equipment Rack Options - Buffet Height Credenzas:			
Fixed Equipment Rack	Add -R2	\$871	Available for 24" deep Credenzas, behind the left most pair of doors
Sliding Equipment Rack	Add -R1	\$3,174	Available for 24" deep Credenzas, behind the left most pair of doors
Waste/Recycling Unit Options:			
Single Pull-Out Waste/Recycling Unit	Add -TF1	\$283	Available for 20" deep Credenzas only (Wall-Hung excluded), behind right most doors
Double Pull-Out Waste/Recycling Unit	Add -TF2	\$438	Available for 24" depth credenzas only (Wall-Hung excluded), behind right most doors



SATIN GLASS TOP

REQUIRED INFORMATION (ORDER CANNOT BE ENTERED WITHOUT THIS INFORMATION):

See pages vi-vii for surface material options.

- Choose Door Style: Defaults to case finish, if none selected
- Choose Metal Finish
- Choose Glass Finish
- Choose Paint Finish, if specified
- Choose Wood Species & Finish, if specified

GENERAL INFORMATION

- Glass is 1/4" -thick back-painted, low-iron glass
- Plank veneer is hand selected walnut veneers of varying character and color, with a clear coat finish, to accentuate the plank appearance
- When Plank veneer door style is specified with a veneer case, case and top will default to clear coat walnut in standard slip-match layup
- When veneer case is specified, the case exterior is standard slip-match layup regardless of veneer door style selection
- Pull-Out Waste/Recycling Bin size: 14" x 10-1/2" x 18"; (1) 36 Qt.; Double Pull-Out Waste/Recycling Units include two bins
- When lock option is specified, color will default based on leg finish:
 - Aged Bronze, Black, Galaxy, Shadow, and Storm: Black
 - Cloud: White
 - Burnish, Foil, and Satin Bronze: Satin Nickel
 - Chrome: Polished Nickel
- Credenzas include one adjustable shelf behind each door unless other components are specified
- Equipment racks hold 12RU and include a thermostatically controlled fan and plug strip



SATIN GLASS TOP

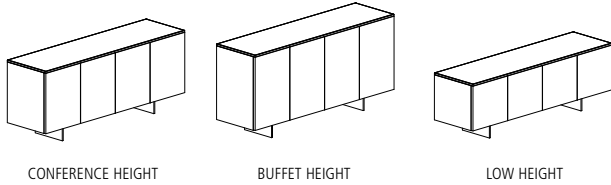

CASE MATERIAL KEY

PA-BB Painted Case with Blade Base
 V-BB Veneer Case with Blade Base

BLADE BASE

MODEL #	W x D x H	DESCRIPTION	-PA-BB	-V-BB
CONFERENCE HEIGHT (23.5 IN. CASE WITH 6.5 IN. BLADE LEG)				
FWLC-3629-SG	36 x 20 x 30	Two Doors	6,323	6,932
FWLC-5429-SG	54 x 20 x 30	Three Doors	8,014	8,808
FWLC-7229-SG	72 x 20 x 30	Four Doors	9,706	10,682
FWLC-9029-SG	90 x 20 x 30	Five Doors	11,402	12,561
FWLD-3629-SG	36 x 24 x 30	Two Doors	6,884	7,553
FWLD-5429-SG	54 x 24 x 30	Three Doors	8,743	9,618
FWLD-7229-SG	72 x 24 x 30	Four Doors	10,608	11,683
FWLD-9029-SG	90 x 24 x 30	Five Doors	12,472	13,750
BUFFET HEIGHT (28.5 IN. CASE WITH 6.5 IN. BLADE LEG)				
FWCC-3636-SG	36 x 20 x 35	Two Doors	6,772	7,428
FWCC-5436-SG	54 x 20 x 35	Three Doors	8,597	9,457
FWCC-7236-SG	72 x 20 x 35	Four Doors	10,429	11,483
FWCC-9036-SG	90 x 20 x 35	Five Doors	12,258	13,511
FWCD-3636-SG	36 x 24 x 35	Two Doors	7,377	8,099
FWCD-5436-SG	54 x 24 x 35	Three Doors	9,387	10,329
FWCD-7236-SG	72 x 24 x 35	Four Doors	11,399	12,559
FWCD-9036-SG	90 x 24 x 35	Five Doors	13,413	14,790
LOW HEIGHT (17.5 IN. CASE WITH 6.5 IN. BLADE LEG)				
FWWC-3624-SG	36 x 20 x 24	Two Doors	5,865	6,421
FWWC-5424-SG	54 x 20 x 24	Three Doors	7,418	8,145
FWWC-7224-SG	72 x 20 x 24	Four Doors	8,973	10,363
FWWC-9024-SG	90 x 20 x 24	Five Doors	10,526	11,595

DOOR STYLE

DESCRIPTION	CODE	NOTES	PRICE
Plank Veneer	-PWD	Available in Clear Coat Walnut	\$289
Vertical Veneer	-VD		No Charge
Horizontal Veneer	-HD		No Charge
Veneer/Paint Combination	-VPD	Reference page 8 for predetermined accent door locations	No Charge
Painted	-PAD		No Charge

OPTIONS

OPTIONS	CODE	PRICE	NOTES
Locks	Add -LK	\$289	
Polished Chrome Base	Add -PCBB	\$460	
Equipment Rack Options - Buffet Height Credenzas:			
Fixed Equipment Rack	Add -R2	\$871	Available for 24" deep Credenzas, behind the left most pair of doors
Sliding Equipment Rack	Add -R1	\$3,174	Available for 24" deep Credenzas, behind the left most pair of doors
Waste/Recycling Unit Options:			
Single Pull-Out Waste/Recycling Unit	Add -TF1	\$283	Available for 20" deep Credenzas only (Wall-Hung excluded), behind right most doors
Double Pull-Out Waste/Recycling Unit	Add -TF2	\$438	Available for 24" depth credenzas only (Wall-Hung excluded), behind right most doors



SATIN GLASS TOP

REQUIRED INFORMATION (ORDER CANNOT BE ENTERED WITHOUT THIS INFORMATION):

See pages vi-vii for surface material options.

- Choose Door Style: Defaults to case finish, if none selected
- Choose Metal Finish
- Choose Glass Finish
- Choose Paint Finish, if specified
- Choose Wood Species & Finish, if specified

GENERAL INFORMATION

- Glass is 1/4" -thick back-painted, low-iron glass
- Plank veneer is hand selected walnut veneers of varying character and color, with a clear coat finish, to accentuate the plank appearance
- When Plank veneer door style is specified with a veneer case, case and top will default to clear coat walnut in standard slip-match layup
- When veneer case is specified, the case exterior is standard slip-match layup regardless of veneer door style selection
- Pull-Out Waste/Recycling Bin size: 14" x 10-1/2" x 18"; (1) 36 Qt.; Double Pull-Out Waste/Recycling Units include two bins
- When lock option is specified, color will default based on leg finish:
 - Aged Bronze, Black, Galaxy, Shadow, and Storm: Black
 - Cloud: White
 - Burnish, Foil, and Satin Bronze: Satin Nickel
 - Chrome: Polished Nickel
- Credenzas include one adjustable shelf behind each door unless other components are specified
- Equipment racks hold 12RU and include a thermostatically controlled fan and plug strip



STONE TOP

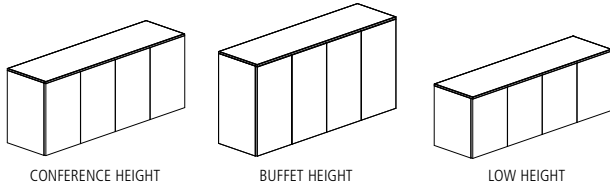

CASE MATERIAL KEY

PA Painted Case
V Veneer Case

CASE ONLY

MODEL #	W x D x H	DESCRIPTION	-PA	-V
CONFERENCE HEIGHT (29.5 INCH CASE)				
FWCC-3629-S	36 x 20 x 29.5	Two Doors	6,759	7,507
FWCC-5429-S	54 x 20 x 29.5	Three Doors	8,797	9,771
FWCC-7229-S	72 x 20 x 29.5	Four Doors	10,839	12,042
FWCC-9029-S	90 x 20 x 29.5	Five Doors	12,881	14,309
FWCD-3629-S	36 x 24 x 29.5	Two Doors	7,434	8,259
FWCD-5429-S	54 x 24 x 29.5	Three Doors	9,678	10,753
FWCD-7229-S	72 x 24 x 29.5	Four Doors	11,923	13,245
FWCD-9029-S	90 x 24 x 29.5	Five Doors	14,167	15,739
BUFFET HEIGHT (36.5 INCH CASE)				
FWBC-3636-S	36 x 20 x 36.5	Two Doors	7,772	8,629
FWBC-5436-S	54 x 20 x 36.5	Three Doors	10,114	11,235
FWBC-7236-S	72 x 20 x 36.5	Four Doors	12,463	13,847
FWBC-9036-S	90 x 20 x 36.5	Five Doors	14,809	16,452
FWBD-3636-S	36 x 24 x 36.5	Two Doors	8,548	9,492
FWBD-5436-S	54 x 24 x 36.5	Three Doors	11,125	12,360
FWBD-7236-S	72 x 24 x 36.5	Four Doors	13,708	15,230
FWBD-9036-S	90 x 24 x 36.5	Five Doors	16,289	18,098
LOW HEIGHT (24.5 INCH CASE)				
FWLC-3624-S	36 x 20 x 24.5	Two Doors	6,258	6,953
FWLC-5424-S	54 x 20 x 24.5	Three Doors	8,146	9,050
FWLC-7224-S	72 x 20 x 24.5	Four Doors	10,035	11,151
FWLC-9024-S	90 x 20 x 24.5	Five Doors	11,927	13,249
FWLD-3624-S	36 x 24 x 24.5	Two Doors	6,884	7,649
FWLD-5424-S	54 x 24 x 24.5	Three Doors	8,961	9,955
FWLD-7224-S	72 x 24 x 24.5	Four Doors	11,039	12,266
FWLD-9024-S	90 x 24 x 24.5	Five Doors	13,117	14,575

DOOR STYLE

DESCRIPTION	CODE	NOTES	PRICE
Plank Veneer	-PWD	Available in Clear Coat Walnut	\$289
Vertical Veneer	-VD		No Charge
Horizontal Veneer	-HD		No Charge
Veneer/Paint Combination	-VPD	Reference page 8 for predetermined accent door locations	No Charge
Painted	-PAD		No Charge



STONE TOP

OPTIONS	CODE	PRICE	NOTES
Locks	Add -LK	\$289	
Drawers Behind Doors (Buffet Height - 36" Case Only)	Add -D	\$564	
Equipment Rack Options - Conference Height and Buffet Height Credenzas:			
Fixed Equipment Rack	Add -R2	\$871	Available for 24" deep Credenzas, behind the left most pair of doors
Sliding Equipment Rack	Add -R1	\$3,174	Available for 24" deep Credenzas, behind the left most pair of doors
Waste/Recycling Unit Options:			
Single Pull-Out Waste/Recycling Unit	Add -TF1	\$283	Available for 20" deep Credenzas only (Wall-Hung excluded), behind right most doors
Double Pull-Out Waste/Recycling Unit	Add -TF2	\$438	Available for 24" depth credenzas only (Wall-Hung excluded), behind right most doors

REQUIRED INFORMATION (ORDER CANNOT BE ENTERED WITHOUT THIS INFORMATION):

See pages vi-vii for surface material options.

- Choose Door Style: Defaults to case finish, if none selected
- Choose Stone Finish
- Choose Paint Finish, if specified
- Choose Wood Species & Finish, if specified

GENERAL INFORMATION

- Stone/Quartz tops are 2cm thick
- Plank veneer is hand selected walnut veneers of varying character and color, with a clear coat finish, to accentuate the plank appearance
- When Plank veneer door style is specified with a veneer case, case and top will default to clear coat walnut in standard slip-match layout
- When veneer case is specified, the case exterior is standard slip-match layout regardless of veneer door style selection
- Pull-Out Waste/Recycling Bin size: 14" x 10-1/2" x 18"; (1) 36 Qt.; Double Pull-Out Waste/Recycling Units include two bins
- Locks
 - Veneer (Case Only) - When lock option is specified, color will default to Satin Nickel
 - Painted (Case Only) - When lock option is specified, color will default based on Paint finish:
 - Aged Bronze, Black, Galaxy, Shadow, and Storm: Black
 - Cloud: White
 - Burnish, Foil, Satin Bronze: Satin Nickel
 - Chrome: Polished Nickel
- Credenzas include one adjustable shelf behind each door unless other components are specified
- Equipment racks hold 12RU and include a thermostatically controlled fan and plug strip



STONE TOP

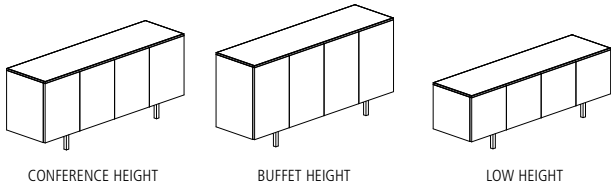

CASE MATERIAL KEY

PA-IB Painted Case with Inset Leg
 V-IB Veneer Case with Inset Leg

INSET LEG

MODEL #	W x D x H	DESCRIPTION	-PA-IB	-V-IB
CONFERENCE HEIGHT (24 IN. CASE WITH 6.5 IN. INSET LEG)				
FWLC-3629-S	36 x 20 x 30.5	Two Doors	6,684	7,380
FWLC-5429-S	54 x 20 x 30.5	Three Doors	8,575	9,478
FWLC-7229-S	72 x 20 x 30.5	Four Doors	10,464	11,577
FWLC-9029-S	90 x 20 x 30.5	Five Doors	12,353	13,677
FWLD-3629-S	36 x 24 x 30.5	Two Doors	7,310	8,076
FWLD-5429-S	54 x 24 x 30.5	Three Doors	9,388	10,384
FWLD-7229-S	72 x 24 x 30.5	Four Doors	11,466	12,694
FWLD-9029-S	90 x 24 x 30.5	Five Doors	13,546	15,003
BUFFET HEIGHT (29 IN. CASE WITH 6.5 IN. INSET LEG)				
FWCC-3636-S	36 x 20 x 35.5	Two Doors	7,186	7,936
FWCC-5436-S	54 x 20 x 35.5	Three Doors	9,226	10,201
FWCC-7236-S	72 x 20 x 35.5	Four Doors	11,267	12,470
FWCC-9036-S	90 x 20 x 35.5	Five Doors	13,308	14,737
FWCD-3636-S	36 x 24 x 35.5	Two Doors	7,860	8,688
FWCD-5436-S	54 x 24 x 35.5	Three Doors	10,106	11,178
FWCD-7236-S	72 x 24 x 35.5	Four Doors	12,348	13,673
FWCD-9036-S	90 x 24 x 35.5	Five Doors	14,596	16,168
LOW HEIGHT (18 IN. CASE WITH 6.5 IN. INSET LEG)				
FWWC-3624-S	36 x 20 x 24.5	Two Doors	6,172	6,811
FWWC-5424-S	54 x 20 x 24.5	Three Doors	7,911	8,739
FWWC-7224-S	72 x 20 x 24.5	Four Doors	9,640	10,664
FWWC-9024-S	90 x 20 x 24.5	Five Doors	11,376	12,591

DOOR STYLE

DESCRIPTION	CODE	NOTES	PRICE
Plank Veneer	-PWD	Available in Clear Coat Walnut	\$289
Vertical Veneer	-VD		No Charge
Horizontal Veneer	-HD		No Charge
Veneer/Paint Combination	-VPD	Reference page 8 for predetermined accent door locations	No Charge
Painted	-PAD		No Charge

OPTIONS	CODE	PRICE	NOTES
Locks	Add -LK	\$289	
Polished Chrome Base	Add -PCIB	\$460	
Equipment Rack Options - Buffet Height Credenzas:			
Fixed Equipment Rack	Add -R2	\$871	Available for 24" deep Credenzas, behind the left most pair of doors
Sliding Equipment Rack	Add -R1	\$3,174	Available for 24" deep Credenzas, behind the left most pair of doors
Waste/Recycling Unit Options:			
Single Pull-Out Waste/Recycling Unit	Add -TF1	\$283	Available for 20" deep Credenzas only (Wall-Hung excluded), behind right most doors
Double Pull-Out Waste/Recycling Unit	Add -TF2	\$438	Available for 24" depth credenzas only (Wall-Hung excluded), behind right most doors



STONE TOP

REQUIRED INFORMATION (ORDER CANNOT BE ENTERED WITHOUT THIS INFORMATION):

See pages vi-vii for surface material options.

- Choose Door Style: Defaults to case finish, if none selected
- Choose Metal Finish
- Choose Stone Finish
- Choose Paint Finish, if specified
- Choose Wood Species & Finish, if specified

GENERAL INFORMATION

- Stone/Quartz tops are 2cm thick
- Plank veneer is hand selected walnut veneers of varying character and color, with a clear coat finish, to accentuate the plank appearance
- When Plank veneer door style is specified with a veneer case, case and top will default to clear coat walnut in standard slip-match layup
- When veneer case is specified, the case exterior is standard slip-match layup regardless of veneer door style selection
- Pull-Out Waste/Recycling Bin size: 14" x 10-1/2" x 18"; (1) 36 Qt.; Double Pull-Out Waste/Recycling Units include two bins
- When lock option is specified, color will default based on leg finish:
 - Aged Bronze, Black, Galaxy, Shadow, and Storm: Black
 - Cloud: White
 - Burnish, Foil, and Satin Bronze: Satin Nickel
 - Chrome: Polished Nickel
- Credenzas include one adjustable shelf behind each door unless other components are specified
- Equipment racks hold 12RU and include a thermostatically controlled fan and plug strip



STONE TOP

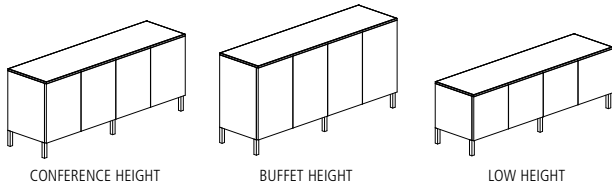

CASE MATERIAL KEY

PA-OB Painted Case with Edge-mount Post Leg
 V-OB Veneer Case with Edge-mount Post Leg

EDGE-MOUNT POST LEG

MODEL #	W x D x H	DESCRIPTION	-PA-OB	-V-OB
CONFERENCE HEIGHT (24 IN. CASE WITH 6.5 IN. EDGE-MOUNT POST LEG)				
FWLC-3629-S	36 x 20 x 30.5	Two Door	6,684	7,380
FWLC-5429-S	54 x 20 x 30.5	Three Door	8,575	9,478
FWLC-7229-S	72 x 20 x 30.5	Four Door	10,464	11,577
FWLC-9029-S	90 x 20 x 30.5	Five Door	12,353	13,677
FWLD-3629-S	36 x 24 x 30.5	Two Door	7,310	8,076
FWLD-5429-S	54 x 24 x 30.5	Three Door	9,388	10,384
FWLD-7229-S	72 x 24 x 30.5	Four Door	11,466	12,694
FWLD-9029-S	90 x 24 x 30.5	Five Door	13,546	15,003
BUFFET HEIGHT (29 IN. CASE WITH 6.5 IN. EDGE-MOUNT POST LEG)				
FWCC-3636-S	36 x 20 x 35.5	Two Door	7,186	7,936
FWCC-5436-S	54 x 20 x 35.5	Three Door	9,226	10,201
FWCC-7236-S	72 x 20 x 35.5	Four Door	11,267	12,470
FWCC-9036-S	90 x 20 x 35.5	Five Door	13,308	14,737
FWCD-3636-S	36 x 24 x 35.5	Two Door	7,860	8,688
FWCD-5436-S	54 x 24 x 35.5	Three Door	10,106	11,178
FWCD-7236-S	72 x 24 x 35.5	Four Door	12,348	13,673
FWCD-9036-S	90 x 24 x 35.5	Five Door	14,596	16,168
LOW HEIGHT (18 IN. CASE WITH 6.5 IN. EDGE-MOUNT POST LEG)				
FWWC-3624-S	36 x 20 x 24.5	Two Door	6,172	6,811
FWWC-5424-S	54 x 20 x 24.5	Three Door	7,911	8,739
FWWC-7224-S	72 x 20 x 24.5	Four Door	9,640	10,664
FWWC-9024-S	90 x 20 x 24.5	Five Door	11,376	12,591

DOOR STYLE

DESCRIPTION	CODE	NOTES	PRICE
Plank Veneer	-PWD	Available in Clear Coat Walnut	\$289
Vertical Veneer	-VD		No Charge
Horizontal Veneer	-HD		No Charge
Veneer/Paint Combination	-VPD	Reference page 8 for predetermined accent door locations	No Charge
Painted	-PAD		No Charge

OPTIONS	CODE	PRICE	NOTES
Locks	Add -LK	\$289	
Polished Chrome Base	Add -PCOB	\$497	
Equipment Rack Options - Buffet Height Credenzas:			
Fixed Equipment Rack	Add -R2	\$871	Available for 24" deep Credenzas, behind the left most pair of doors
Sliding Equipment Rack	Add -R1	\$3,174	Available for 24" deep Credenzas, behind the left most pair of doors
Waste/Recycling Unit Options:			
Single Pull-Out Waste/Recycling Unit	Add -TF1	\$283	Available for 20" deep Credenzas only (Wall-Hung excluded), behind right most doors
Double Pull-Out Waste/Recycling Unit	Add -TF2	\$438	Available for 24" depth credenzas only (Wall-Hung excluded), behind right most doors



STONE TOP

REQUIRED INFORMATION (ORDER CANNOT BE ENTERED WITHOUT THIS INFORMATION):

See pages vi-vii for surface material options.

- Choose Door Style: Defaults to case finish, if none selected
- Choose Metal Finish
- Choose Stone Finish
- Choose Paint Finish, if specified
- Choose Wood Species & Finish, if specified

GENERAL INFORMATION

- Stone/Quartz tops are 2cm thick
- Plank veneer is hand selected walnut veneers of varying character and color, with a clear coat finish, to accentuate the plank appearance
- When Plank veneer door style is specified with a veneer case, case and top will default to clear coat walnut in standard slip-match layup
- When veneer case is specified, the case exterior is standard slip-match layup regardless of veneer door style selection
- Pull-Out Waste/Recycling Bin size: 14" x 10-1/2" x 18"; (1) 36 Qt.; Double Pull-Out Waste/Recycling Units include two bins
- When lock option is specified, color will default based on leg finish:
 - Aged Bronze, Black, Galaxy, Shadow, and Storm: Black
 - Cloud: White
 - Burnish, Foil, and Satin Bronze: Satin Nickel
 - Chrome: Polished Nickel
- Credenzas include one adjustable shelf behind each door unless other components are specified
- Equipment racks hold 12RU and include a thermostatically controlled fan and plug strip



STONE TOP

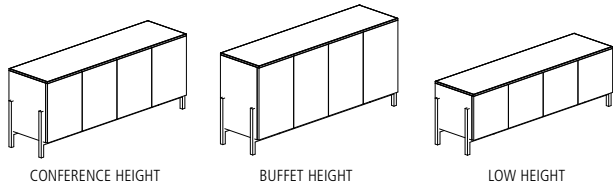

CASE MATERIAL KEY

PA-CB Painted Case with Cradle Base
 V-CB Veneer Case with Cradle Base

CRADLE BASE

MODEL #	W x D x H	DESCRIPTION	-PA-CB	-V-CB
CONFERENCE HEIGHT (24 IN. CASE WITH 6.5 IN. CRADLE BASE)				
FWLC-3629-S	36 x 20 x 30.5	Two Doors	7,257	7,951
FWLC-5429-S	54 x 20 x 30.5	Three Doors	9,147	10,048
FWLC-7229-S	72 x 20 x 30.5	Four Doors	11,034	12,148
FWLC-9029-S	90 x 20 x 30.5	Five Doors	12,925	14,247
FWLD-3629-S	36 x 24 x 30.5	Two Doors	7,884	8,647
FWLD-5429-S	54 x 24 x 30.5	Three Doors	9,958	10,954
FWLD-7229-S	72 x 24 x 30.5	Four Doors	12,038	13,265
FWLD-9029-S	90 x 24 x 30.5	Five Doors	14,117	15,573
BUFFET HEIGHT (29 IN. CASE WITH 6.5 IN. CRADLE BASE)				
FWCC-3636-S	36 x 20 x 35.5	Two Doors	7,756	8,506
FWCC-5436-S	54 x 20 x 35.5	Three Doors	9,796	10,771
FWCC-7236-S	72 x 20 x 35.5	Four Doors	11,837	13,040
FWCC-9036-S	90 x 20 x 35.5	Five Doors	13,877	15,306
FWCD-3636-S	36 x 24 x 35.5	Two Doors	8,431	9,258
FWCD-5436-S	54 x 24 x 35.5	Three Doors	10,674	11,750
FWCD-7236-S	72 x 24 x 35.5	Four Doors	12,921	14,244
FWCD-9036-S	90 x 24 x 35.5	Five Doors	15,166	16,739
LOW HEIGHT (18 IN. CASE WITH 6.5 IN. CRADLE BASE)				
FWWC-3624-S	36 x 20 x 24.5	Two Doors	6,743	7,381
FWWC-5424-S	54 x 20 x 24.5	Three Doors	8,482	9,310
FWWC-7224-S	72 x 20 x 24.5	Four Doors	10,212	11,235
FWWC-9024-S	90 x 20 x 24.5	Five Doors	11,946	13,163

DOOR STYLE

DESCRIPTION	CODE	NOTES	PRICE
Plank Veneer	-PWD	Available in Clear Coat Walnut	\$289
Vertical Veneer	-VD		No Charge
Horizontal Veneer	-HD		No Charge
Veneer/Paint Combination	-VPD	Reference page 8 for predetermined accent door locations	No Charge
Painted	-PAD		No Charge

OPTIONS

	CODE	PRICE	NOTES
Locks	Add -LK	\$289	
Polished Chrome Base	Add -PCCB	\$1,632	
Equipment Rack Options - Buffet Height Credenzas:			
Fixed Equipment Rack	Add -R2	\$871	Available for 24" deep Credenzas, behind the left most pair of doors
Sliding Equipment Rack	Add -R1	\$3,174	Available for 24" deep Credenzas, behind the left most pair of doors
Waste/Recycling Unit Options:			
Single Pull-Out Waste/Recycling Unit	Add -TF1	\$283	Available for 20" deep Credenzas only (Wall-Hung excluded), behind right most doors
Double Pull-Out Waste/Recycling Unit	Add -TF2	\$438	Available for 24" depth credenzas only (Wall-Hung excluded), behind right most doors



STONE TOP

REQUIRED INFORMATION (ORDER CANNOT BE ENTERED WITHOUT THIS INFORMATION):

See pages vi-vii for surface material options.

- Choose Door Style: Defaults to case finish, if none selected
- Choose Metal Finish
- Choose Stone Finish
- Choose Paint Finish, if specified
- Choose Wood Species & Finish, if specified

GENERAL INFORMATION

- Stone/Quartz tops are 2cm thick
- Plank veneer is hand selected walnut veneers of varying character and color, with a clear coat finish, to accentuate the plank appearance
- When Plank veneer door style is specified with a veneer case, case and top will default to clear coat walnut in standard slip-match layup
- When veneer case is specified, the case exterior is standard slip-match layup regardless of veneer door style selection
- Pull-Out Waste/Recycling Bin size: 14" x 10-1/2" x 18"; (1) 36 Qt.; Double Pull-Out Waste/Recycling Units include two bins
- When lock option is specified, color will default based on leg finish:
 - Aged Bronze, Black, Galaxy, Shadow, and Storm: Black
 - Cloud: White
 - Burnish, Foil, and Satin Bronze: Satin Nickel
 - Chrome: Polished Nickel
- Credenzas include one adjustable shelf behind each door unless other components are specified
- Equipment racks hold 12RU and include a thermostatically controlled fan and plug strip



STONE TOP

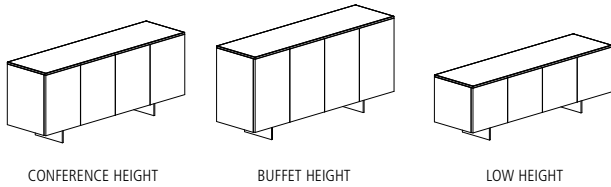

CASE MATERIAL KEY

PA-BB Painted Case with Blade Base
 V-BB Veneer Case with Blade Base

BLADE BASE

MODEL #	W x D x H	DESCRIPTION	-PA-BB	-V-BB
CONFERENCE HEIGHT (24 IN. CASE WITH 6.5 IN. BLADE LEG)				
FWLC-3629-S	36 x 20 x 30.5	Two Doors	6,971	7,665
FWLC-5429-S	54 x 20 x 30.5	Three Doors	8,860	9,762
FWLC-7229-S	72 x 20 x 30.5	Four Doors	10,749	11,864
FWLC-9029-S	90 x 20 x 30.5	Five Doors	12,639	13,963
FWLD-3629-S	36 x 24 x 30.5	Two Doors	7,598	8,360
FWLD-5429-S	54 x 24 x 30.5	Three Doors	9,676	10,669
FWLD-7229-S	72 x 24 x 30.5	Four Doors	11,753	12,977
FWLD-9029-S	90 x 24 x 30.5	Five Doors	13,832	15,287
BUFFET HEIGHT (29 IN. CASE WITH 6.5 IN. BLADE LEG)				
FWCC-3636-S	36 x 20 x 35.5	Two Doors	7,473	8,220
FWCC-5436-S	54 x 20 x 35.5	Three Doors	9,511	10,485
FWCC-7236-S	72 x 20 x 35.5	Four Doors	11,552	12,757
FWCC-9036-S	90 x 20 x 35.5	Five Doors	13,594	15,020
FWCD-3636-S	36 x 24 x 35.5	Two Doors	8,146	8,973
FWCD-5436-S	54 x 24 x 35.5	Three Doors	10,389	11,464
FWCD-7236-S	72 x 24 x 35.5	Four Doors	12,636	13,960
FWCD-9036-S	90 x 24 x 35.5	Five Doors	14,881	16,453
LOW HEIGHT (18 IN. CASE WITH 6.5 IN. BLADE LEG)				
FWWC-3624-S	36 x 20 x 24.5	Two Doors	6,458	7,096
FWWC-5424-S	54 x 20 x 24.5	Three Doors	8,196	9,024
FWWC-7224-S	72 x 20 x 24.5	Four Doors	9,927	10,951
FWWC-9024-S	90 x 20 x 24.5	Five Doors	11,662	12,876

DOOR STYLE

DESCRIPTION	CODE	NOTES	PRICE
Plank Veneer	-PWD	Available in Clear Coat Walnut	\$289
Vertical Veneer	-VD		No Charge
Horizontal Veneer	-HD		No Charge
Veneer/Paint Combination	-VPD	Reference page 8 for predetermined accent door locations	No Charge
Painted	-PAD		No Charge

OPTIONS

OPTIONS	CODE	PRICE	NOTES
Locks	Add -LK	\$289	
Polished Chrome Base	Add -PCBB	\$460	
Equipment Rack Options - Buffet Height Credenzas:			
Fixed Equipment Rack	Add -R2	\$871	Available for 24" deep Credenzas, behind the left most pair of doors
Sliding Equipment Rack	Add -R1	\$3,174	Available for 24" deep Credenzas, behind the left most pair of doors
Waste/Recycling Unit Options:			
Single Pull-Out Waste/Recycling Unit	Add -TF1	\$283	Available for 20" deep Credenzas only (Wall-Hung excluded), behind right most doors
Double Pull-Out Waste/Recycling Unit	Add -TF2	\$438	Available for 24" depth credenzas only (Wall-Hung excluded), behind right most doors



STONE TOP

REQUIRED INFORMATION (ORDER CANNOT BE ENTERED WITHOUT THIS INFORMATION):

See pages vi-vii for surface material options.

- Choose Door Style: Defaults to case finish, if none selected
- Choose Metal Finish
- Choose Stone Finish
- Choose Paint Finish, if specified
- Choose Wood Species & Finish, if specified

GENERAL INFORMATION

- Stone/Quartz tops are 2cm thick
- Plank veneer is hand selected walnut veneers of varying character and color, with a clear coat finish, to accentuate the plank appearance
- When Plank veneer door style is specified with a veneer case, case and top will default to clear coat walnut in standard slip-match layup
- When veneer case is specified, the case exterior is standard slip-match layup regardless of veneer door style selection
- Pull-Out Waste/Recycling Bin size: 14" x 10-1/2" x 18"; (1) 36 Qt.; Double Pull-Out Waste/Recycling Units include two bins
- When lock option is specified, color will default based on leg finish:
 - Aged Bronze, Black, Galaxy, Shadow, and Storm: Black
 - Cloud: White
 - Burnish, Foil, and Satin Bronze: Satin Nickel
 - Chrome: Polished Nickel
- Credenzas include one adjustable shelf behind each door unless other components are specified
- Equipment racks hold 12RU and include a thermostatically controlled fan and plug strip



SOLID SURFACE TOP

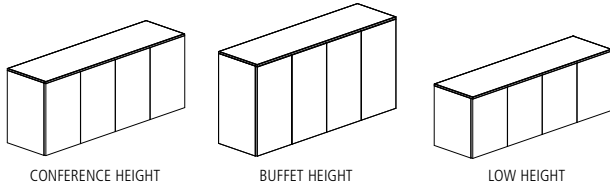

CASE MATERIAL KEY

PA Painted Case
V Veneer Case

CASE ONLY

MODEL #	W x D x H	DESCRIPTION	-PA	-V
CONFERENCE HEIGHT (29 INCH CASE)				
FWCC-3629-SS	36 x 20 x 29	Two Doors	6,258	6,951
FWCC-5429-SS	54 x 20 x 29	Three Doors	8,146	9,052
FWCC-7229-SS	72 x 20 x 29	Four Doors	10,035	11,151
FWCC-9029-SS	90 x 20 x 29	Five Doors	11,927	13,249
FWCD-3629-SS	36 x 24 x 29	Two Doors	6,884	7,646
FWCD-5429-SS	54 x 24 x 29	Three Doors	8,961	9,956
FWCD-7229-SS	72 x 24 x 29	Four Doors	11,039	12,265
FWCD-9029-SS	90 x 24 x 29	Five Doors	13,117	14,575
BUFFET HEIGHT (36 INCH CASE)				
FWBC-3636-SS	36 x 20 x 36	Two Doors	7,193	7,996
FWBC-5436-SS	54 x 20 x 36	Three Doors	9,365	10,405
FWBC-7236-SS	72 x 20 x 36	Four Doors	11,539	12,818
FWBC-9036-SS	90 x 20 x 36	Five Doors	13,712	15,236
FWBD-3636-SS	36 x 24 x 36	Two Doors	7,916	8,793
FWBD-5436-SS	54 x 24 x 36	Three Doors	10,302	11,444
FWBD-7236-SS	72 x 24 x 36	Four Doors	12,693	14,104
FWBD-9036-SS	90 x 24 x 36	Five Doors	15,083	16,758
LOW HEIGHT (24 INCH CASE)				
FWLC-3624-SS	36 x 20 x 24	Two Doors	5,797	6,437
FWLC-5424-SS	54 x 20 x 24	Three Doors	7,543	8,385
FWLC-7224-SS	72 x 20 x 24	Four Doors	9,293	10,326
FWLC-9024-SS	90 x 20 x 24	Five Doors	11,043	12,269
FWLD-3624-SS	36 x 24 x 24	Two Doors	6,372	7,080
FWLD-5424-SS	54 x 24 x 24	Three Doors	8,298	9,219
FWLD-7224-SS	72 x 24 x 24	Four Doors	10,223	11,358
FWLD-9024-SS	90 x 24 x 24	Five Doors	12,147	13,497

DOOR STYLE

DESCRIPTION	CODE	NOTES	PRICE
Plank Veneer	-PWD	Available in Clear Coat Walnut	\$289
Vertical Veneer	-VD		No Charge
Horizontal Veneer	-HD		No Charge
Veneer/Paint Combination	-VPD	Reference page 8 for predetermined accent door locations	No Charge
Painted	-PAD		No Charge



SOLID SURFACE TOP

OPTIONS	CODE	PRICE	NOTES
Locks	Add -LK	\$289	
Drawers Behind Doors (Buffet Height - 36" Case Only)	Add -D	\$564	
Equipment Rack Options - Conference Height and Buffet Height Credenzas:			
Fixed Equipment Rack	Add -R2	\$871	Available for 24" deep Credenzas, behind the left most pair of doors
Sliding Equipment Rack	Add -R1	\$3,174	Available for 24" deep Credenzas, behind the left most pair of doors
Waste/Recycling Unit Options:			
Single Pull-Out Waste/Recycling Unit	Add -TF1	\$283	Available for 20" deep Credenzas only (Wall-Hung excluded), behind right most doors
Double Pull-Out Waste/Recycling Unit	Add -TF2	\$438	Available for 24" depth credenzas only (Wall-Hung excluded), behind right most doors

REQUIRED INFORMATION (ORDER CANNOT BE ENTERED WITHOUT THIS INFORMATION):

See pages vi-vii for surface material options.

- Choose Door Style: Defaults to case finish, if none selected
- Choose Solid Surface Finish
- Choose Paint Finish, if specified
- Choose Wood Species & Finish, if specified

GENERAL INFORMATION

- Solid Surface tops are 1/2" thick
- Plank veneer is hand selected walnut veneers of varying character and color, with a clear coat finish, to accentuate the plank appearance
- When Plank veneer door style is specified with a veneer case, case and top will default to clear coat walnut in standard slip-match layup
- When veneer case is specified, the case exterior is standard slip-match layup regardless of veneer door style selection
- Pull-Out Waste/Recycling Bin size: 14" x 10-1/2" x 18"; (1) 36 Qt.; Double Pull-Out Waste/Recycling Units include two bins
- Locks
 - Veneer (Case Only) - When lock option is specified, color will default to Satin Nickel
 - Painted (Case Only) - When lock option is specified, color will default based on Paint finish:
 - Aged Bronze, Black, Galaxy, Shadow, and Storm: Black
 - Cloud: White
 - Burnish, Foil, Satin Bronze: Satin Nickel
 - Chrome: Polished Nickel
- Credenzas include one adjustable shelf behind each door unless other components are specified
- Equipment racks hold 12RU and include a thermostatically controlled fan and plug strip



SOLID SURFACE TOP

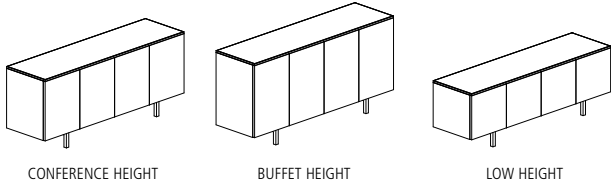

CASE MATERIAL KEY

PA-IB Painted Case with Inset Leg
 V-IB Veneer Case with Inset Leg

INSET LEG

MODEL #	W x D x H	DESCRIPTION	-PA-IB	-V-IB
CONFERENCE HEIGHT (23.5 IN. CASE WITH 6.5 IN. INSET LEG)				
FWLC-3629-SS	36 x 20 x 30	Two Doors	6,225	6,867
FWLC-5429-SS	54 x 20 x 30	Three Doors	7,969	8,809
FWLC-7229-SS	72 x 20 x 30	Four Doors	9,719	10,750
FWLC-9029-SS	90 x 20 x 30	Five Doors	11,468	12,696
FWLD-3629-SS	36 x 24 x 30	Two Doors	6,800	7,508
FWLD-5429-SS	54 x 24 x 30	Three Doors	8,724	9,649
FWLD-7229-SS	72 x 24 x 30	Four Doors	10,649	11,786
FWLD-9029-SS	90 x 24 x 30	Five Doors	12,575	13,926
BUFFET HEIGHT (28.5 IN. CASE WITH 6.5 IN. INSET LEG)				
FWCC-3636-SS	36 x 20 x 35	Two Doors	6,684	7,379
FWCC-5436-SS	54 x 20 x 35	Three Doors	8,575	9,480
FWCC-7236-SS	72 x 20 x 35	Four Doors	10,464	11,577
FWCC-9036-SS	90 x 20 x 35	Five Doors	12,353	13,677
FWCD-3636-SS	36 x 24 x 35	Two Doors	7,310	8,073
FWCD-5436-SS	54 x 24 x 35	Three Doors	9,388	10,385
FWCD-7236-SS	72 x 24 x 35	Four Doors	11,466	12,693
FWCD-9036-SS	90 x 24 x 35	Five Doors	13,546	15,003
LOW HEIGHT (17.5 IN. CASE WITH 6.5 IN. INSET LEG)				
FWWC-3624-SS	36 x 20 x 24	Two Doors	5,909	6,338
FWWC-5424-SS	54 x 20 x 24	Three Doors	7,562	8,125
FWWC-7224-SS	72 x 20 x 24	Four Doors	9,213	9,906
FWWC-9024-SS	90 x 20 x 24	Five Doors	10,868	11,690

DOOR STYLE

DESCRIPTION	CODE	NOTES	PRICE
Plank Veneer	-PWD	Available in Clear Coat Walnut	\$289
Vertical Veneer	-VD		No Charge
Horizontal Veneer	-HD		No Charge
Veneer/Paint Combination	-VPD	Reference page 8 for predetermined accent door locations	No Charge
Painted	-PAD		No Charge

OPTIONS

	CODE	PRICE	NOTES
Locks	Add -LK	\$289	
Polished Chrome Base	Add -PCIB	\$460	
Equipment Rack Options - Buffet Height Credenzas:			
Fixed Equipment Rack	Add -R2	\$871	Available for 24" deep Credenzas, behind the left most pair of doors
Sliding Equipment Rack	Add -R1	\$3,174	Available for 24" deep Credenzas, behind the left most pair of doors
Waste/Recycling Unit Options:			
Single Pull-Out Waste/Recycling Unit	Add -TF1	\$283	Available for 20" deep Credenzas only (Wall-Hung excluded), behind right most doors
Double Pull-Out Waste/Recycling Unit	Add -TF2	\$438	Available for 24" depth credenzas only (Wall-Hung excluded), behind right most doors



SOLID SURFACE TOP

REQUIRED INFORMATION (ORDER CANNOT BE ENTERED WITHOUT THIS INFORMATION):

See pages vi-vii for surface material options.

- Choose Door Style: Defaults to case finish, if none selected
- Choose Metal Finish
- Choose Solid Surface Finish
- Choose Paint Finish, if specified
- Choose Wood Species & Finish, if specified

GENERAL INFORMATION

- Solid Surface tops are 1/2" thick
- Plank veneer is hand selected walnut veneers of varying character and color, with a clear coat finish, to accentuate the plank appearance
- When Plank veneer door style is specified with a veneer case, case and top will default to clear coat walnut in standard slip-match layup
- When veneer case is specified, the case exterior is standard slip-match layup regardless of veneer door style selection
- Pull-Out Waste/Recycling Bin size: 14" x 10-1/2" x 18"; (1) 36 Qt.; Double Pull-Out Waste/Recycling Units include two bins
- When lock option is specified, color will default based on leg finish:
 - Aged Bronze, Black, Galaxy, Shadow, and Storm: Black
 - Cloud: White
 - Burnish, Foil, and Satin Bronze: Satin Nickel
 - Chrome: Polished Nickel
- Credenzas include one adjustable shelf behind each door unless other components are specified
- Equipment racks hold 12RU and include a thermostatically controlled fan and plug strip



SOLID SURFACE TOP

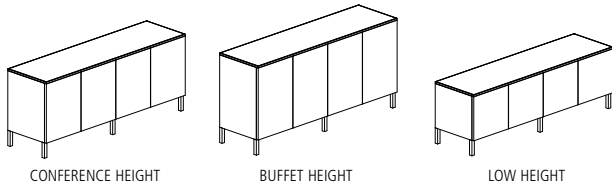

CASE MATERIAL KEY

PA-OB Painted Case with Edge-mount Post Leg
 V-OB Veneer Case with Edge-mount Post Leg

EDGE-MOUNT POST LEG

MODEL #	W x D x H	DESCRIPTION	-PA-OB	-V-OB
CONFERENCE HEIGHT (23.5 IN. CASE WITH 6.5 IN. EDGE-MOUNT POST LEG)				
FWLC-3629-SS	36 x 20 x 30	Two Door	6,225	6,867
FWLC-5429-SS	54 x 20 x 30	Three Door	7,969	8,809
FWLC-7229-SS	72 x 20 x 30	Four Door	9,719	10,750
FWLC-9029-SS	90 x 20 x 30	Five Door	11,468	12,696
FWLD-3629-SS	36 x 24 x 30	Two Door	6,800	7,508
FWLD-5429-SS	54 x 24 x 30	Three Door	8,724	9,649
FWLD-7229-SS	72 x 24 x 30	Four Door	10,649	11,786
FWLD-9029-SS	90 x 24 x 30	Five Door	12,575	13,926
BUFFET HEIGHT (28.5 IN. CASE WITH 6.5 IN. EDGE-MOUNT POST LEG)				
FWCC-3636-SS	36 x 20 x 35	Two Door	6,684	7,379
FWCC-5436-SS	54 x 20 x 35	Three Door	8,575	9,480
FWCC-7236-SS	72 x 20 x 35	Four Door	10,464	11,577
FWCC-9036-SS	90 x 20 x 35	Five Door	12,353	13,677
FWCD-3636-SS	36 x 24 x 35	Two Door	7,310	8,073
FWCD-5436-SS	54 x 24 x 35	Three Door	9,388	10,385
FWCD-7236-SS	72 x 24 x 35	Four Door	11,466	12,693
FWCD-9036-SS	90 x 24 x 35	Five Door	13,546	15,003
LOW HEIGHT (17.5 IN. CASE WITH 6.5 IN. EDGE-MOUNT POST LEG)				
FWWC-3624-SS	36 x 20 x 24	Two Door	5,909	6,338
FWWC-5424-SS	54 x 20 x 24	Three Door	7,562	8,125
FWWC-7224-SS	72 x 20 x 24	Four Door	9,213	9,906
FWWC-9024-SS	90 x 20 x 24	Five Door	10,868	11,690

DOOR STYLE

DESCRIPTION	CODE	NOTES	PRICE
Plank Veneer	-PWD	Available in Clear Coat Walnut	\$289
Vertical Veneer	-VD		No Charge
Horizontal Veneer	-HD		No Charge
Veneer/Paint Combination	-VPD	Reference page 8 for predetermined accent door locations	No Charge
Painted	-PAD		No Charge

OPTIONS	CODE	PRICE	NOTES
Locks	Add -LK	\$289	
Polished Chrome Base	Add -PCOB	\$497	
Equipment Rack Options - Buffet Height Credenzas:			
Fixed Equipment Rack	Add -R2	\$871	Available for 24" deep Credenzas, behind the left most pair of doors
Sliding Equipment Rack	Add -R1	\$3,174	Available for 24" deep Credenzas, behind the left most pair of doors
Waste/Recycling Unit Options:			
Single Pull-Out Waste/Recycling Unit	Add -TF1	\$283	Available for 20" deep Credenzas only (Wall-Hung excluded), behind right most doors
Double Pull-Out Waste/Recycling Unit	Add -TF2	\$438	Available for 24" depth credenzas only (Wall-Hung excluded), behind right most doors



SOLID SURFACE TOP

REQUIRED INFORMATION (ORDER CANNOT BE ENTERED WITHOUT THIS INFORMATION):

See pages vi-vii for surface material options.

- Choose Door Style: Defaults to case finish, if none selected
- Choose Metal Finish
- Choose Solid Surface Finish
- Choose Paint Finish, if specified
- Choose Wood Species & Finish, if specified

GENERAL INFORMATION

- Solid Surface tops are 1/2" thick
- Plank veneer is hand selected walnut veneers of varying character and color, with a clear coat finish, to accentuate the plank appearance
- When Plank veneer door style is specified with a veneer case, case and top will default to clear coat walnut in standard slip-match layup
- When veneer case is specified, the case exterior is standard slip-match layup regardless of veneer door style selection
- Pull-Out Waste/Recycling Bin size: 14" x 10-1/2" x 18"; (1) 36 Qt.; Double Pull-Out Waste/Recycling Units include two bins
- When lock option is specified, color will default based on leg finish:
 - Aged Bronze, Black, Galaxy, Shadow, and Storm: Black
 - Cloud: White
 - Burnish, Foil, and Satin Bronze: Satin Nickel
 - Chrome: Polished Nickel
- Credenzas include one adjustable shelf behind each door unless other components are specified
- Equipment racks hold 12RU and include a thermostatically controlled fan and plug strip



SOLID SURFACE TOP

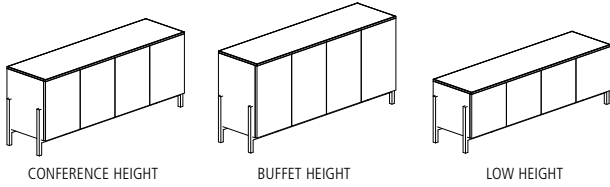

CASE MATERIAL KEY

PA-CB Painted Case with Cradle Base
 V-CB Veneer Case with Cradle Base

CRADLE BASE

MODEL #	W x D x H	DESCRIPTION	-PA-CB	-V-CB
CONFERENCE HEIGHT (23.5 IN. CASE WITH 6.5 IN. CRADLE BASE)				
FWLC-3629-SS	36 x 20 x 30	Two Doors	6,793	7,438
FWLC-5429-SS	54 x 20 x 30	Three Doors	8,540	9,379
FWLC-7229-SS	72 x 20 x 30	Four Doors	10,289	11,322
FWLC-9029-SS	90 x 20 x 30	Five Doors	12,040	13,268
FWLD-3629-SS	36 x 24 x 30	Two Doors	7,374	8,079
FWLD-5429-SS	54 x 24 x 30	Three Doors	9,296	10,220
FWLD-7229-SS	72 x 24 x 30	Four Doors	11,221	12,354
FWLD-9029-SS	90 x 24 x 30	Five Doors	13,147	14,496
BUFFET HEIGHT (28.5 IN. CASE WITH 6.5 IN. CRADLE BASE)				
FWCC-3636-SS	36 x 20 x 35	Two Doors	7,257	7,950
FWCC-5436-SS	54 x 20 x 35	Three Doors	9,147	10,050
FWCC-7236-SS	72 x 20 x 35	Four Doors	11,034	12,148
FWCC-9036-SS	90 x 20 x 35	Five Doors	12,925	14,247
FWCD-3636-SS	36 x 24 x 35	Two Doors	7,884	8,644
FWCD-5436-SS	54 x 24 x 35	Three Doors	9,958	10,955
FWCD-7236-SS	72 x 24 x 35	Four Doors	12,038	13,263
FWCD-9036-SS	90 x 24 x 35	Five Doors	14,117	15,573
LOW HEIGHT (17.5 IN. CASE WITH 6.5 IN. CRADLE BASE)				
FWWC-3624-SS	36 x 20 x 24	Two Doors	6,481	6,908
FWWC-5424-SS	54 x 20 x 24	Three Doors	8,135	8,695
FWWC-7224-SS	72 x 20 x 24	Four Doors	9,786	10,478
FWWC-9024-SS	90 x 20 x 24	Five Doors	11,439	12,263

DOOR STYLE

DESCRIPTION	CODE	NOTES	PRICE
Plank Veneer	-PWD	Available in Clear Coat Walnut	\$289
Vertical Veneer	-VD		No Charge
Horizontal Veneer	-HD		No Charge
Veneer/Paint Combination	-VPD	Reference page 8 for predetermined accent door locations	No Charge
Painted	-PAD		No Charge

OPTIONS

	CODE	PRICE	NOTES
Locks	Add -LK	\$289	
Polished Chrome Base	Add -PCCB	\$1,632	
Equipment Rack Options - Buffet Height Credenzas:			
Fixed Equipment Rack	Add -R2	\$871	Available for 24" deep Credenzas, behind the left most pair of doors
Sliding Equipment Rack	Add -R1	\$3,174	Available for 24" deep Credenzas, behind the left most pair of doors
Waste/Recycling Unit Options:			
Single Pull-Out Waste/Recycling Unit	Add -TF1	\$283	Available for 20" deep Credenzas only (Wall-Hung excluded), behind right most doors
Double Pull-Out Waste/Recycling Unit	Add -TF2	\$438	Available for 24" depth credenzas only (Wall-Hung excluded), behind right most doors



SOLID SURFACE TOP

REQUIRED INFORMATION (ORDER CANNOT BE ENTERED WITHOUT THIS INFORMATION):

See pages vi-vii for surface material options.

- Choose Door Style: Defaults to case finish, if none selected
- Choose Metal Finish
- Choose Solid Surface Finish
- Choose Paint Finish, if specified
- Choose Wood Species & Finish, if specified

GENERAL INFORMATION

- Solid Surface tops are 1/2" thick
- Plank veneer is hand selected walnut veneers of varying character and color, with a clear coat finish, to accentuate the plank appearance
- When Plank veneer door style is specified with a veneer case, case and top will default to clear coat walnut in standard slip-match layup
- When veneer case is specified, the case exterior is standard slip-match layup regardless of veneer door style selection
- Pull-Out Waste/Recycling Bin size: 14" x 10-1/2" x 18"; (1) 36 Qt.; Double Pull-Out Waste/Recycling Units include two bins
- When lock option is specified, color will default based on leg finish:
 - Aged Bronze, Black, Galaxy, Shadow, and Storm: Black
 - Cloud: White
 - Burnish, Foil, and Satin Bronze: Satin Nickel
 - Chrome: Polished Nickel
- Credenzas include one adjustable shelf behind each door unless other components are specified
- Equipment racks hold 12RU and include a thermostatically controlled fan and plug strip



SOLID SURFACE TOP

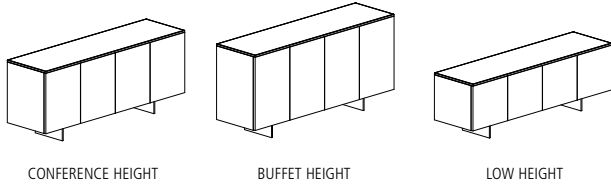

CASE MATERIAL KEY

PA-BB Painted Case with Blade Base
 V-BB Veneer Case with Blade Base

BLADE BASE

MODEL #	W x D x H	DESCRIPTION	-PA-BB	-V-BB
CONFERENCE HEIGHT (23.5 IN. CASE WITH 6.5 IN. BLADE LEG)				
FWLC-3629-SS	36 x 20 x 30	Two Doors	6,508	7,151
FWLC-5429-SS	54 x 20 x 30	Three Doors	8,255	9,092
FWLC-7229-SS	72 x 20 x 30	Four Doors	10,004	11,036
FWLC-9029-SS	90 x 20 x 30	Five Doors	11,755	12,981
FWLD-3629-SS	36 x 24 x 30	Two Doors	7,087	7,793
FWLD-5429-SS	54 x 24 x 30	Three Doors	9,010	9,934
FWLD-7229-SS	72 x 24 x 30	Four Doors	10,932	12,070
FWLD-9029-SS	90 x 24 x 30	Five Doors	12,860	14,210
BUFFET HEIGHT (28.5 IN. CASE WITH 6.5 IN. BLADE LEG)				
FWCC-3636-SS	36 x 20 x 35	Two Doors	6,971	7,663
FWCC-5436-SS	54 x 20 x 35	Three Doors	8,860	9,765
FWCC-7236-SS	72 x 20 x 35	Four Doors	10,749	11,864
FWCC-9036-SS	90 x 20 x 35	Five Doors	12,639	13,963
FWCD-3636-SS	36 x 24 x 35	Two Doors	7,598	8,357
FWCD-5436-SS	54 x 24 x 35	Three Doors	9,676	10,670
FWCD-7236-SS	72 x 24 x 35	Four Doors	11,753	12,976
FWCD-9036-SS	90 x 24 x 35	Five Doors	13,832	15,287
LOW HEIGHT (17.5 IN. CASE WITH 6.5 IN. BLADE LEG)				
FWWC-3624-SS	36 x 20 x 24	Two Doors	6,195	6,623
FWWC-5424-SS	54 x 20 x 24	Three Doors	7,849	8,412
FWWC-7224-SS	72 x 20 x 24	Four Doors	9,499	10,192
FWWC-9024-SS	90 x 20 x 24	Five Doors	11,154	11,975

DOOR STYLE

DESCRIPTION	CODE	NOTES	PRICE
Plank Veneer	-PWD	Available in Clear Coat Walnut	\$289
Vertical Veneer	-VD		No Charge
Horizontal Veneer	-HD		No Charge
Veneer/Paint Combination	-VPD	Reference page 8 for predetermined accent door locations	No Charge
Painted	-PAD		No Charge

OPTIONS

OPTIONS	CODE	PRICE	NOTES
Locks	Add -LK	\$289	
Polished Chrome Base	Add -PCBB	\$460	
Equipment Rack Options - Buffet Height Credenzas:			
Fixed Equipment Rack	Add -R2	\$871	Available for 24" deep Credenzas, behind the left most pair of doors
Sliding Equipment Rack	Add -R1	\$3,174	Available for 24" deep Credenzas, behind the left most pair of doors
Waste/Recycling Unit Options:			
Single Pull-Out Waste/Recycling Unit	Add -TF1	\$283	Available for 20" deep Credenzas only (Wall-Hung excluded), behind right most doors
Double Pull-Out Waste/Recycling Unit	Add -TF2	\$438	Available for 24" depth credenzas only (Wall-Hung excluded), behind right most doors



SOLID SURFACE TOP

REQUIRED INFORMATION (ORDER CANNOT BE ENTERED WITHOUT THIS INFORMATION):

See pages vi-vii for surface material options.

- Choose Door Style: Defaults to case finish, if none selected
- Choose Metal Finish
- Choose Solid Surface Finish
- Choose Paint Finish, if specified
- Choose Wood Species & Finish, if specified

GENERAL INFORMATION

- Solid Surface tops are 1/2" thick
- Plank veneer is hand selected walnut veneers of varying character and color, with a clear coat finish, to accentuate the plank appearance
- When Plank veneer door style is specified with a veneer case, case and top will default to clear coat walnut in standard slip-match layup
- When veneer case is specified, the case exterior is standard slip-match layup regardless of veneer door style selection
- Pull-Out Waste/Recycling Bin size: 14" x 10-1/2" x 18"; (1) 36 Qt.; Double Pull-Out Waste/Recycling Units include two bins
- When lock option is specified, color will default based on leg finish:
 - Aged Bronze, Black, Galaxy, Shadow, and Storm: Black
 - Cloud: White
 - Burnish, Foil, and Satin Bronze: Satin Nickel
 - Chrome: Polished Nickel
- Credenzas include one adjustable shelf behind each door unless other components are specified
- Equipment racks hold 12RU and include a thermostatically controlled fan and plug strip



Appendix



GENERAL INFORMATION

This price book supercedes all previous versions.

Before placing your order, confirm you have all required information necessary. Lead times for orders begin after all required information is included and correct.

Delivery Information

We know lead times are important and sticking to them even more so. We work to maintain a 6-8 week lead time on all standard products in this book from receipt of a clean order. All orders are acknowledged with an approximate shipping date and will be invoiced with the price in effect at the date the purchase order is received.

Shipping charges are prepaid (within the continental U.S.). Therefore, pricing is a delivered price based on normal ground transportation. If you have special instructions, need to ship by air, or are shipping to Alaska or Hawaii, contact Nucraft Customer Service. Nucraft can also help arrange to have products blanket wrapped for an additional charge. Contact the Nucraft Customer Service team or specify it on your purchase order.

Minimum Freight Charge: Any order below \$2,800 net will be assessed a \$450 net minimum freight charge (one per order).

Orders are subject to acquiring the materials required for manufacturing. Fulfillment can be affected by strikes, fires, embargoes and acts of government. These elements are beyond our control.

Nucraft offers a variety of services to accommodate a wide range of delivery requirements. Availability of these services is dependent on a number of factors and may not be offered with all shipments. Examples of delivery services that have additional fees include:

- Specific date within our standard 3-5 day delivery window (for orders under \$50,000 net)
- Specific time of day, morning or afternoon (for orders under \$50,000 net)
- Delivery to a warehouse before delivery to its final destination (unless product is picked up at the warehouse)

Contact the Nucraft Customer Service team for availability and pricing on these services.

Freight Terms

Shipping charges for Nucraft products are prepaid for standard delivery in the continental United States. Standard delivery is defined as follows: Product is delivered on a 53' trailer being pulled by a long-haul tractor (total length of 85'). Facility will receive delivery Monday through Friday between the hours of 8:00 AM and 4:00 PM. Facility has docks with levelers and a fork truck for unloading. Product will be loaded on load bars two levels high. Receiving facility is responsible to have personnel on hand to unload the truck upon arrival, drivers do not unload. Delivery sites or times that do not meet this criteria will be accommodated, but will typically incur a charge to cover additional shipping costs. Please notify Nucraft in advance of the shipment if this is the case and the additional charge (if any) will be determined by Nucraft.

Product ships FOB dock. The customer obtains title to their product and materials, and assumes the risk of loss for them, upon shipment from Nucraft's facilities.

Storage

Nucraft has no storage facilities for finished product. If a customer cannot accept an order when it is ready for shipment, the customer must designate an alternative shipping address. If no address is provided, Nucraft may, at its discretion, transfer the product to storage. If product is transferred to an off-site storage facility, the customer may be charged for transportation to the facility and for any associated storage fees. Nucraft considers transfer of the product to a storage facility the equivalent of shipment, including invoicing and payment. Customers assume the risk of damage or loss during storage.

Transportation Times and Delays

Third party carriers that Nucraft contracts with will make reasonable efforts to accommodate requested delivery times and dates. Scheduled delivery appointments may, however, be delayed for a variety of reasons, including inclement weather, traffic, transportation equipment problems, and delays encountered at other delivery locations along the delivery route. Nucraft does not recommend scheduling activities that depend on the delivery appointment (for example, scheduling furniture installers to install furniture the day of the delivery appointment). Nucraft shall not be liable for any costs incurred as a result of a missed delivery appointment.

Shipment Damage Claims

Legal title to merchandise passes to the buyer upon acceptance by the carrier. **Inspect all cartons upon delivery.** Details of visible damage should be noted on the delivery receipt. Do not install product if damage is found upon inspection. The carrier should be notified by the buyer to inspect the merchandise, and file a claim immediately. If visible damage is not apparent, sign the delivery receipt "No visible damage." This will allow recourse for a concealed damage claim. Although most claims for transportation damages must be filed against the carrier within nine months of the date of delivery, concealed damage claims must be filed within 15 days of receipt.

Do not destroy packing materials until shipment has been inspected. Then proceed to file a claim with the carrier.

Failure to make any claims against Nucraft within 10 days shall constitute acceptance of the merchandise and a waiver of any defects, errors or shortages discovered upon inspection.

Cancellations

Cancellations must be reviewed by our Customer Service team. Because we build your products to order, orders cannot be cancelled once processing has begun. Processing includes but is not limited to development of shop drawings and other engineering drawings. If cancellation is approved, a processing fee of 20-100% will be assessed based on the status of the order.

Change Order Policy

Nucraft will make every attempt to honor any reasonable change request to product provided that the request is received prior to start of production. Change orders will be accepted only if the request is made in writing and received in time to make the change. Nucraft reserves the right to increase our acknowledged price and ship date if necessary to make the requested changes. Please submit any change order request to our Customer Service team. Nucraft will assess charges to the customer as stipulated in the following:

- Standard Orders: Change orders received prior to production will be charged \$400 net to cover administrative costs.
- Special Orders: Change orders received prior to production will be charged \$400 net to cover administrative costs. There may be additional costs associated with engineering labor required for the change order.
- Change orders received after production must be evaluated by Nucraft. If approved, the charge will be \$400 net plus any restocking charges accumulated. There may be additional costs associated with engineering and/or manufacturing labor, as well as material costs, required for the change order.



GENERAL INFORMATION

Repair Authorization

Prior written approval is required for repairs of merchandise charged to Nucraft. Failure to do so will result in customer funded repairs.

Payment Terms

Deposits are required at the time of order due to the custom nature of our products. See information regarding Cancellations above.

Credit terms are available to qualified customers. Please contact AR@Nucraft.com to start the application process. Note that the credit application process requires a valid sales tax exemption or resale tax certificate, Form W-9, and three current trade references.

Credit Card Payments are accepted via web portal. Please contact AR@Nucraft.com for payment instructions. Note that a 2% convenience fee will be added for using this payment method and no early pay discounts are allowed on credit card payments.

Warranty

Nucraft Furniture is warranted to be free from defects in materials and workmanship for a period of ten years of single shift use. Limitations include:

- Mechanical Devices such as latches, casters, and other moving components are warranted for five years of the date of original delivery.
- Height adjustable components are warranted for two years of the date of original delivery.
- The following are warranted for one year of the date of original delivery:
 - Textiles
 - Electrical Components
 - Refrigeration Units
 - Custom Products not described in Nucraft's Catalogue

This warranty is applicable only if furniture is properly installed and maintained in an office environment. This warranty extends only to products manufactured and sold in North America and only to original purchasers acquiring new Nucraft product through authorized dealers or approved sellers.

During this warranty period, Nucraft's sole obligation is to repair or replace, at Nucraft's discretion, products which prove to be defective during the warranty period.

This warranty does not cover:

- Damage caused by a carrier.
- Damage from user modification, misuse, abuse, accident, or negligence.
- Customer's Own Material (COM) specified by the customer that is not a standard product offering.
- Color, grain, or texture of wood and other covering material.

Nucraft extends no other warranties, expressed or implied, including warranty of merchantability or fitness for a particular purpose. Nucraft shall not be liable for loss of time, inconvenience, commercial loss, incidental or consequential damages.

Environmental Statement

Nucraft is committed to supporting responsible environmental policies and practices in all that we do. We strive for sustainability, weighing our business decisions against the costs to the ecological, social and economic systems they affect.

Our products are manufactured to meet the credit requirements of the U.S. Green Building Council's LEED rating systems in one or more of the following categories:

- Recycled Content
- Certified Wood
- Low-Emitting Materials

Computer Aided Planning

Nucraft products and pricing are available on CD via 2020 Cap, an AutoCAD®-based space planning tool.

2020 Cap is an integrated software system developed specifically for interior designers and facility planners to enhance workplace performance. This modern suite of applications works together seamlessly, in concert. Navigate catalogs, select products, design in plan view and 3D, assign options, create worksheets and build a project where you want, when you want. Take your pick. It's dynamic and interactive. Design projects are a work in progress. And now you can perform any of the many discrete tasks that go into a project any time, any place.

For additional information, you may contact 2020 Cap direct at 800-227-0038.

iSpec®

Nucraft offers a free online product configuration and specification service that saves you time and allows you to be creative while leaving the nuts and bolts to someone else. No specific software is required, nor is there any learning curve. This service applies to all Nucraft products. For additional information, call 1-877-NUCRAFT and ask for the iSpec Team or log on to www.nucraft.com/ispec.



FINISH INFORMATION

Surface Materials Palette

We crafted our materials palette using the same demanding standards that distinguish our furniture. Thoughtful design and attention to every detail elevate your possibilities.

Anchored by NuCraft veneers, unrivaled for clarity, quality, and depth of finish, our collection of surface materials comprises a sophisticated set of balanced elements that supports your design vision.

Some elements have their roots in NuCraft’s rich heritage. Others are new materials and reflect current trends and taste. Together, they ensure that you’re ready for today and positioned well for the future. Beautifully.

Custom Finishes

NuCraft specializes in expert custom finish matching. For a nominal upcharge we can provide custom finishes, and we are frequently asked to match the finishes of other furniture manufacturers. For finishes that appear unusual to match or for customers directly requesting a sample, a finish sample will be sent for approval prior to entering the order.

Custom finishes requiring colored varnishes to create a painted look can only be applied to Maple veneer and require one extra week in addition to the standard lead time. NuCraft’s standard black finish (G82) can be applied to all NuCraft standard veneers. Walnut is the standard black veneer. Other species must be specified when ordering.

Clear coat on a special veneer requires an approved sample.

Custom finishes carry a 10% upcharge per item, per finish, capped at \$1,975 List.

Custom finish upcharges are not applied to any item that is not wood. Example: casters, ganging connectors, power options..

Treatments

Note: Default veneer sheen will vary per finish and product. Default finish is bolded on pages vi-vii. If no direction is provided on incoming orders, default sheen will be selected. In addition, default veneer cut is noted in the price list. If no direction is provided on incoming orders, default cut will be selected.

Gloss: Gloss is a durable finish that tends to nicely mask normal wear and leaves wood grain visible to the eye. It achieves a medium gloss open pore appearance (40 – 50 sheen range). Finish numbers preceded by the letter “G” indicate a Gloss finish.

Matte: Like Gloss, Matte is durable, tends to nicely mask normal wear and leaves wood grain visible to the eye. It achieves a low luster, open pore appearance (10 – 20 sheen range). Finish numbers preceded by the letter “M” indicate a Matte finish.

Since each veneer type responds differently to both types of treatment, all will have a distinctive look and feel when finished. For example, a Walnut veneer with a Gloss treatment will remain much more textured than a Cherry veneer with the same treatment.

About the Wood

All NuCraft veneers are carefully selected for uniformity of color and grain. Still, wood is a natural substance and minor variations may occur due to its own uniqueness. Because of this, the furniture you receive may not be an exact match to our samples.

NuCraft takes great pride in our finish color consistency. However, wood is a natural product that will have color variation within a single piece of furniture, as well as from one piece to the next. Other factors also affect color over time, such as exposure to light (both intensity and duration). For example, lighter finishes cause more variation in colors over time.

In cases where a returning customer wants a precise match with existing furniture, we recommend sending a sample of the existing furniture finish. Please contact NuCraft Customer Service to determine an appropriate sample. This will ensure a finish match between old and new orders. This type of order is considered a control sample. There will be a 10% upcharge on an order of this type. Due to natural aging of veneers, natural finishes may vary.

Care and Maintenance of Wood Finishes

Our finish material is a crystal clear, urethane acrylic blend. This type of finish may be repaired in the field by a qualified refinisher.

NuCraft recommends using a damp cloth to clean your fine wood furniture. Always wipe with the grain of the wood. Should your wood furniture require a more thorough cleaning, we recommend using a mild cleaner such as Joy dish soap or Murphy’s oil soap, thoroughly diluted in water (one part soap to thirty parts water). Water will not damage NuCraft’s finish, but it may leave surface spots when it dries. To avoid this, dry the surface with a soft cloth after it is cleaned. Marks that cannot be removed with the cleaning methods above may be able to be removed using naphtha, a mild degreasing solvent.

Caution: while the use of polishes that contain wax, petroleum solvents or silicones may immediately enhance the “shine” of a product, it may also eventually remove the fine original finish applied in our factory. Silicone on the surface of wood may also make it very difficult to respray or refinish.

All NuCraft furniture is inspected and polished before it leaves our factory. In some instances, the packing materials may imprint on the factory polish. Cleaning and polishing the furniture once it is unpacked will normally restore the furniture to its original beauty.

In some cases, the rubber support feet used on the bottom of common office equipment (teleconferencing phones, laptops, microphones, copiers, etc.) can create unsightly marks in the surface of wood tops, due to oxidation of the lacquer finish. We suggest these machines be placed on a protective type of padding, such as felt.

Wood will fade as a result of exposure to UV light. This is particularly prevalent with light finishes. If color changes due to fading are a concern for your application, the impact can be minimized by selecting medium to dark stains for your wood surfaces. Our top coat includes a UV inhibitor which makes the finishes less prone to fading.



FINISH INFORMATION

Laminates

Selected Formica® and Nevamar® laminates are available on Training Tables, Conference Tables, Conference Room Furniture and select Occasional Tables. For standard laminate and wood pricing, refer to individual item pricing columns.

Non-Standard Laminates and Linoleums

To order a color other than those on our list (see pages vi-vii), refer to Nevamar or Formica standard grade, matte texture laminate offerings and Forbo Furniture Linoleums (excluding manufacturers' non-standard matte offering).

- For approved non-standard laminates with a hardwood edge, the upcharge is 10% of the base price per laminate color with a minimum of \$500 and capped at \$1975.
- For approved non-standard laminate with a standard ABS edge, the upcharge is \$175 per laminate color.
- For approved non-standard laminates with a non standard ABS edge, please contact customer service.

To ensure your non standard laminate is on our approved list, please contact customer service. Add one week to the lead-time for all non-standard laminate and linoleum orders. Call the Nucraft Customer Service team for quotes on premium grades and laminates. Mirror and metal laminates are not available.

Care and Maintenance of Laminate and Novawrap

Laminate and Novawrap surfaces may be cleaned with a damp cloth and ordinary soap or non-abrasive household liquid detergent. Dry the surface with a clean cloth or soft paper towel to prevent streaks from appearing.

Care and Maintenance of Metal

Metal surfaces can be wiped with a damp cloth and rubbed dry. A mild non-abrasive household liquid detergent can be used if necessary. Regular maintenance of metal components, including tightening of fasteners and light lubrication of moving parts, will extend the life of your furniture.

Satin Etched Glass

Glass color may vary slightly on multi-piece conference table tops over 180" x 60" when satin etched glass is specified due to the iron content and etching process of the glass.

Care and Maintenance of Glass

Clear or frosted glass may be cleaned with commercial glass cleaner. Be sure to use a lint-free cloth if cleaning the frosted side of the glass.

Stone and Solid Surface Material

Despite its reputation for durability, natural stone can easily be broken during handling and/or installation if proper techniques are not followed. In addition, Nucraft is not responsible for the installation of natural stone or solid surface materials on its products. Therefore, installers specifically trained in the installation of these materials must be utilized to ensure a quality installation. Nucraft shall not be liable for any damages incurred during the handling and/or installation of natural stone or solid surface materials on its products.

Care and Maintenance of Granite

Granite surfaces may be cleaned with a damp cloth and ordinary soap or non-abrasive household liquid detergent. Dry the surface with a clean cloth or soft paper towel to prevent streaks from appearing.

Care and Maintenance of Leather

Genuine leather requires very little care. Nucraft recommends that leather be dusted regularly. If a more thorough cleaning is needed, use lukewarm water and a mild, non-abrasive soap. Generate some lather and lightly rub the surface with cheesecloth. Rinse off any soap film with clean water and towel dry. The leather may dry dull. To restore the leather to a normal gloss, rub it with a clean towel. Never use furniture polish, oil, varnish or ammonia. Saddle soap may be used to prevent the leather from becoming brittle or cracked and to maintain the original supple finish.

Touch Up Finish Kits

Model #	Description	Price
KIT-M	Metal Kit	80
KIT-P	Paint Kit	80
KIT-S	Stain Kit	80

REQUIRED INFORMATION: (ORDER CANNOT BE ENTERED WITHOUT THIS INFORMATION)

- Kit model number
- Quantity of kits
- Specify finish (See pages vi-vii)

General Information:

- Touch-up kits must be ordered on a purchase order separate from Nucraft product due to Hazmat shipping



WOOD FINISHES

STANDARD

Default veneer sheen will vary per finish and were determined by a team of experts who reviewed the colorways to determine if gloss or matte best highlighted the natural characteristics of the species of wood and the color of the stain. Default finish is bolded. If no direction is provided, default sheen will be selected.

	Matte	Gloss
Ash		
Blanco	M44	G44
Char	M50	G50
Rift Cut Oak		
Carbon	M03	G03
Flat Cut Oak		
Dune	M05	G05
Portobello	M7413	G7413
Flaky Oak		
Sahara	M61	G61
Cherry		
Cognac	M21	G21
Auburn	M93	G93
Walnut		
Marron	M35	G35
Mocha	M33	G33
Zinc	M30	G30
Onyx	M82	G82
Otter	M31	G31
Maple		
Natural Maple	M60	G60
Linea		
Oak Linea	M08	G08
Walnut Linea	M27	G27
Euro Birch Linea	M09	G09
Silver Birch Linea	M10	G10
Paldao		
Thicket	M75	G75
Paldao	M76	G76
Canyon	M77	G77

PLANK

Plank offers dramatic variations in veneer leaf color, length, and natural characteristics; it simulates randomly matched veneers

	Matte	Gloss
Plank Walnut		
Clear Coat	M38	G38

METAL FINISHES

Powder Coat

Aged Bronze	A8010
Black	A44
Burnished	A8009
Cloud	A8004
Foil	A8006
Galaxy	A8007
Satin Bronze	A8011
Shadow	A8005
Storm	A8012

Metal

Clear Anodized	CA
Polished Chrome*	PC

*Up-Charge applies.

PAINTS

Aged Bronze	S8010
Black	S44
Burnished	S88
Cloud	S8004
Foil	S8006
Galaxy	S8007
Moonlight	S87
Satin Bronze	S8011
Shadow	S8005
Storm	S8012

Paint to Match

To request a custom paint color, contact Nucraft Customer Service. A paint sample must be matched and approved prior to order.



STONE TOPS

Stone orders may affect lead times. Please contact NuCraft Customer Service for details.

		Subtop Paint Color
Quartz Cambria® Signature		
Ainsley	STC100	S8004
Armitage	STC101	S44
Bellingham	STC102	S8004
Berkeley	STC103	S8004
Berwyn	STC104	S8004
Blackbrook	STC105	S44
Bradshaw	STC106	S8004
Bradwell	STC107	S8004
Cambria Black	STC109	S44
Carrick	STC110	S44
Clifton	STC112	S8004
Colton	STC113	S8004
Crowndale	STC114	S8004
Devon	STC115	S44
Fairbourne	STC116	S8004
Fieldstone	STC117	S44
Halewood	STC119	S8004
Hermitage	STC120	S8004
Highgate	STC121	S8004
Kendal	STC122	S8004
Laneshaw	STC124	S44
Malvern	STC125	S8004
Montgomery	STC128	S8004
Nevern	STC129	S8004
New Quay	STC130	S8004
Pendle Hill	STC131	S8004
Praa Sands	STC132	S8004
Rose Bay	STC133	S8004
Sandgate	STC135	S8004
Smithfield	STC136	S8004
Summerhill	STC137	S8004
Sutherland	STC138	S8004
Swanbridge	STC139	S8004
Torquay	STC140	S8004
Travella	STC141	S8004
Weybourne	STC143	S8004
Whitney	STC144	S8004
Woodcroft	STC146	S44

Quartz | Cambria® Luxury

Abbey	STC147	S8004
Annicca	STC148	S8004
Baybridge	STC149	S8004
Beckington	STC150	S8004
Bentley	STC151	S8004
Blackpool Matte	STC152	S44
Brittanicca	STC153	S8004
Brittanicca Gold Cool	STC154	S8004
Brittanicca Gold Warm	STC155	S8004
Brittanicca Warm	STC156	S8004
Clovelly	STC158	S8004
Delamere	STC159	S44
Delgatie	STC160	S8004
Ella	STC161	S8004
Everleigh	STC162	S8004
Gladstone	STC163	S8004
Golden Dragon	STC164	S44
Hailey	STC165	S8004
Harlow	STC166	S8004
Hemsworth	STC167	S8004
Huntley	STC168	S8004
Inverness Bristol Bay	STC169	S8004
Inverness Bronze	STC170	S8004
Inverness Cobalt	STC171	S8004
Inverness Everleigh	STC172	S8004
Inverness Platinum	STC173	S8004
Inverness Swansea	STC174	S8004
Ironsbridge	STC175	S8004
Iverness Frost	STC176	S8004
Iverness Gold	STC177	S8004
Ivybridge	STC178	S8004
Lakedale	STC179	S8004
Mayfair	STC181	S8004
Mersey	STC182	S44
Notting Hill	STC183	S8004
Oakleigh	STC184	S8004
Portrush	STC185	S8004
Queen Anne	STC186	S8006
Skara Brae	STC187	S8004
Southport	STC188	S8004
White Cliff	STC189	S8004

Quartz | Wilsonart

Carrara Codena	ST21	S8004
Serene	ST17	S8004

Stone

Absolute Black Honed Granite	ST01	S8007
Carrara Marble	ST16	S8004



SOLID SURFACE TOPS

Available on round tables and credenza tops only

Wilsonart Designer White ST11

GLASS (SATIN OR GLOSS)

	Satin	Gloss
Black	BS	-
Clove	VS	VG
Meringue	MS	MG
Quill	QS	QG
White	WS	WG

Note: Due to color variation inherent in the natural acid etching process, Satin Etched Glass is not available on tables longer than 180" or wider than 60"

LAMINATES

	Code	Coordinating Veneer Case Wood Edge Finish	Coordinating Woodgrain Edgeband
Wood Grain Laminates			
Formica White Ash	8841-58	M8841	R8841
Formica Natural Ash	8843-58	M8843	R8843
Formica Aged Ash	8844-58	M8844	R8844
Formica Weathered Ash	8842-58	M8842	R8842
Formica Oiled Legno	8846-58	M8846	R8846
Formica Bleached Legno	8845-58	M8845	R8845
Formica Blackened Legno	8848-58	M8848	R8848
Formica Urban Planked Oak	9312-58	M9312	R9312
Formica Thermo Walnut	6402-58	M6402	R6402
Formica Smoky Brown Pear	5488-58	M5488	R5488
Formica Espresso Pear	5489-58	M5489	R5489
Formica Pecan Woodline	5883-58	M5883	R5883
Formica Chestnut Woodline	5884-58	M5884	R5884
Formica White Knotty Maple	7410-58	M7410	7410
Formica Sand Maple	9237-58	G60	W7909
Formica Planked Coffee Oak	7413-58	M7413	F7413

	Code	Matching ABS Edgeband
Solid Laminates		
Formica Brite White	459-58	R01
Formica Dover White	7197-58	R01
Formica Pearl	934-58	R02
Formica Graystone	464-58	R02
Formica Folkstone	927-58	R03
Formica Graphite	837-58	R05

	Code	Matching ABS Edgeband
Patterned Laminates		
Nevamar Cool Chic	VA7002T	R02
Nevamar Serene Stardom	VA5001T	R05
Nevamar Calm Distinction	VA6001T	R05
Nevamar Easy Elegance	VA5002T	R05
Wilsonart Sheer Mesh	4876-38	R02
Wilsonart Grey Mesh	4877-38	R02
Wilsonart Pewter Mesh	4878-38	R05

ABS FINISHES

Ashen	R04
Parchment	R02
Shale	R05
Stone	R03
Whitecap	R01