

FLOW™ CREDENZA

GSA Planning Guide + Price List

QUICK LINKS

[PLANNING GUIDE](#)

[FLOW CREDENZA PRICING](#)

[GENERAL INFORMATION](#)

[FINISH INFORMATION](#)

[SURFACE MATERIALS](#)



TABLE OF CONTENTS

Click the shortcuts below to jump to each section.

General Information	ii-iii
Finish Information	iv-v
Surface Materials	vi-viii
Statement of Line	3
Specification Overview	4
FLOW CREDENZA	
Exterior Components	5
Interior Components	6
Component Dimensions	7-8
Base Styles	9
Door Styles	10
Dimensions	11-12
Price List	13-112
Veneer Top with Hardwood Edge	13-22
Fenix® Top with Hardwood Edge	23-32
Fenix® Top with Square Edge	33-42
Laminate Top with Hardwood Edge	43-52
Laminate Top with Square Edge	53-62
Gloss Glass Top	63-72
Satin Glass Top	73-82
Stone/Quartz Top with Square Edge	83-92
Stone/Quartz Top with Full Bullnose Edge	93-102
Solid Surface Top	103-112

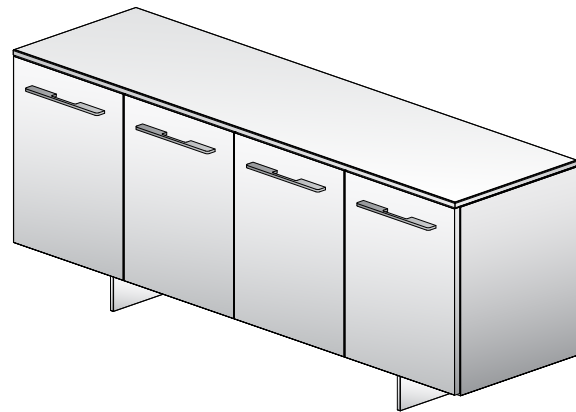
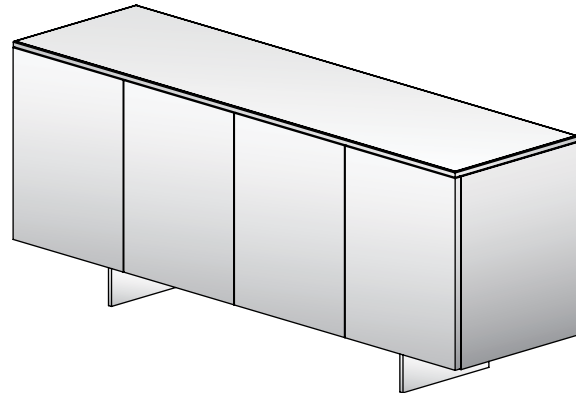



STATEMENT OF LINE

CASE STYLE

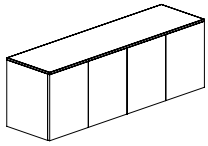

Conference Height

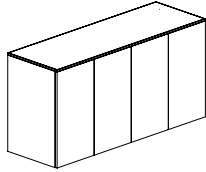

Buffet Height

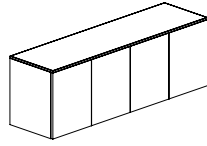

Low Height

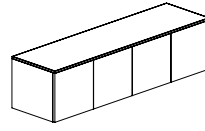

Wall-Hung

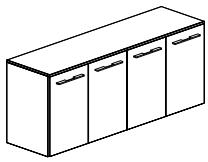

Conference Height

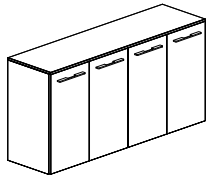

Buffet Height

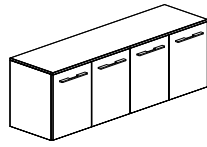

Low Height

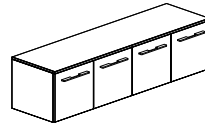

Wall-Hung

BASE STYLE

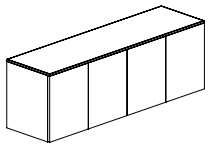

Case Only

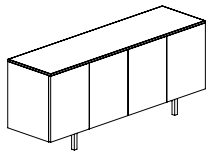

Inset Leg

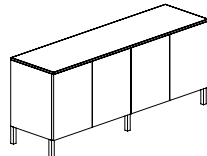

Edge-mount Leg

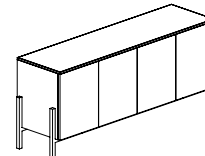

Cradle

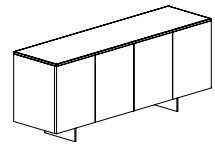

Blade

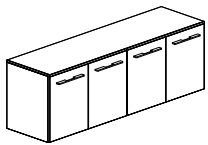

Case Only

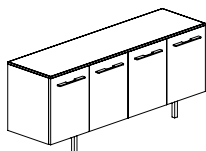

Inset Leg

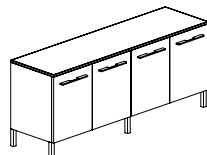

Edge-mount Leg

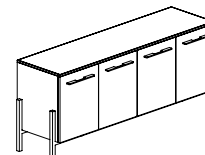

Cradle

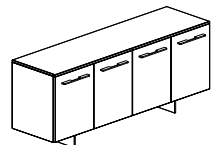

Blade



SPECIFICATION OVERVIEW

FLOW CREDENZA

1. Select Top Material

Choose from veneer, stone, glass, solid-surface, Fenix® or laminate.

2. Select Base Style

Choose case only, or one of four base styles: inset, edge-mount, cradle, or blade. All base styles are available in powder coat or polished metal.

3. Select Case Material

Choose laminate, painted, or veneer. All standard laminates and veneers are available as well as a variety of paint options.

4. Select Case Size

First pick the credenza height: wall-hung, low, conference, or buffet. Then choose the number of doors: 2, 3, 4, or 5.

5. Select Door Style

Pick a design: vertical veneer, horizontal veneer, or painted and veneer door front combinations.

6. Select Pull Style

Choose push latch, ideal for a clean aesthetic without pulls, or the handle pull, which adds visual interest. Enhanced amenities, including the pull-out wood framed waste/recycling unit or drawer refrigerator require the handle pull.

7. Options

- Locks
- A cutout and thermostatically-controlled fan can be added to the back panel for cable management and to remove heat generated by enclosed equipment
- Additional components:
 - One pull-out drawer behind each door
 - Front-opening single or double waste bin systems
 - Sliding or fixed equipment racks
 - Single Drawer Refrigerator



EXTERIOR COMPONENTS

TOP MATERIALS AND EDGE PROFILES

- Veneer tops are 3/4”-thick with a 3/16”-deep hardwood square edge
- Fenix® and Laminate tops are 3/4”- thick with a 3/16”-deep hardwood or 2 mm square edge
- Glass is 1/4”-thick back-painted, low-iron glass
- Stone tops are 2 cm thick with square or full bullnose edge
- Solid surface tops are 1/2”-thick with square edge

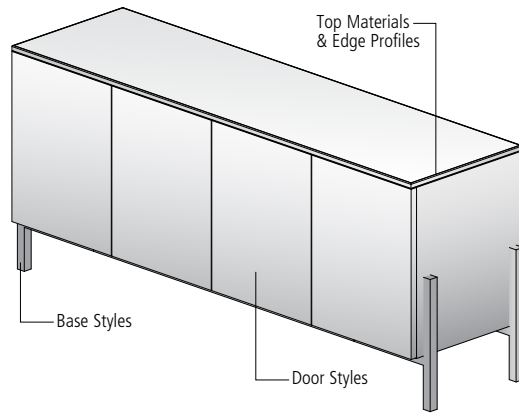

BASE STYLES

- Case only selection includes a full-size case with 1/2” adjustable glides
- All metal post leg options are 1-1/4” square
- The metal blade leg option is 1/2”-thick
- Finishes for all metal legs: powder coat or polished chrome

DOOR STYLES

- Laminate door style will match laminate case finish
- Vertical veneer direction in a slip-match layup is available in all standard wood species and finishes
- Horizontal veneer direction is available in both slip-match and book-match layups dependent upon wood species
- Painted door style can match powder coat or Fenix® colors

Push Latch

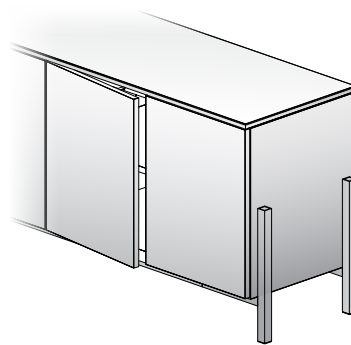

Handle Pull

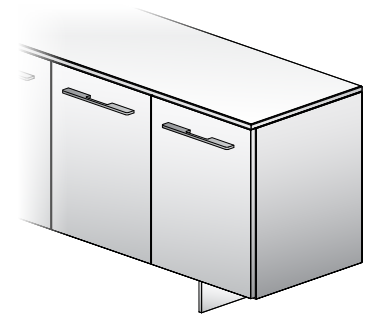

PULL STYLES

- Push Latch - Ideal for a clean aesthetic, with no pulls. To open a door, simply press gently and the door will open approximately 1-1/2”, enough to easily reach behind to open. To close, simply press the door until the push-latch engages. Hinges will keep the door closed.
- Handle Pull - Adds visual interest while providing a tangible grip. When selected, pull will be applied to all door fronts. Required for pull-out component options that are applied to door panel.

Drawer Refrigerator Cutout

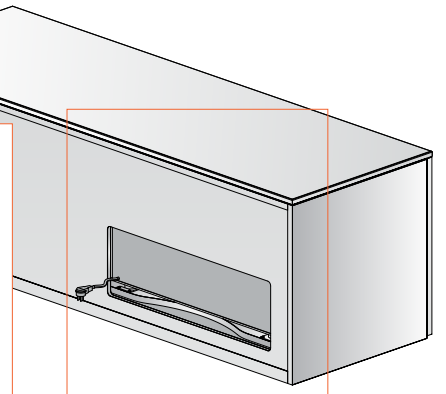
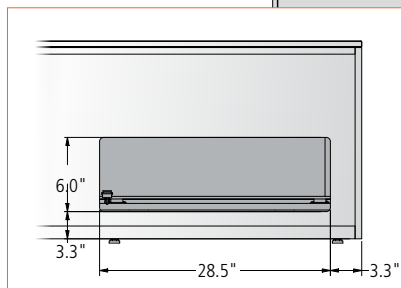

VENTILATION AND CUTOUTS

- Drawer Refrigerator includes a 28-1/2” x 6” cutout with black vent cover for ease of installation, alignment, and power cord connection
- Racked Equipment includes a 9” square and 3-1/2” round cutout to route additional cables or accommodate a thermostatically-controlled fan

Racked Equipment Cutout

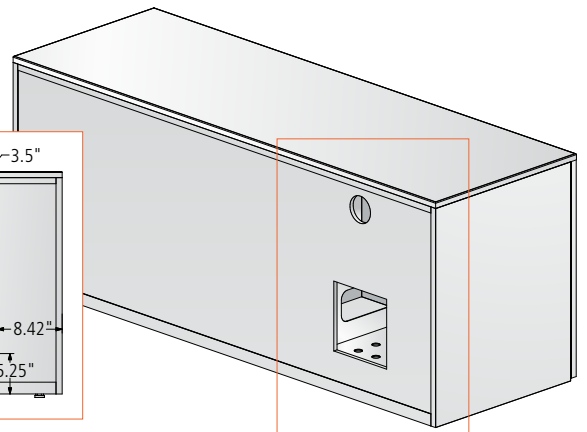
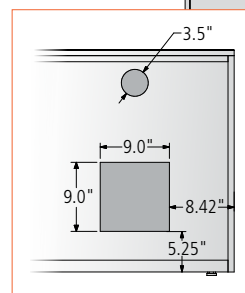



INTERIOR COMPONENTS

SHELF & DRAWER OPTIONS

- One drawer behind each credenza door may be specified on case only buffet height credenza
- Drawer box will be gray with applied front to match case exterior

PULL-OUT WASTE/RECYCLING

- Wire frame units:
 - behind door
 - available with push latch or handle pull
- Wood frame units:
 - applied to door
 - available with handle pull only
- Single wire/wood frame unit:
 - (1) Gray 35qt. bin
 - available on 20" depth, 54"-90" width credenzas
- Double wire/wood frame unit:
 - (2) Gray 35qt. bins
 - available on 24" depth, 54"-90" width credenzas.
- Single and double units are located in the rightmost door
- Dual units leverage full rightmost cabinet space to double capacity. Available on 72"-90" width credenzas
- Shelf above included on all buffet and case only conference height credenzas
- Bin Size: 17-7/8" x 8-3/32" x 11-9/16"

Shelf and Drawer Options

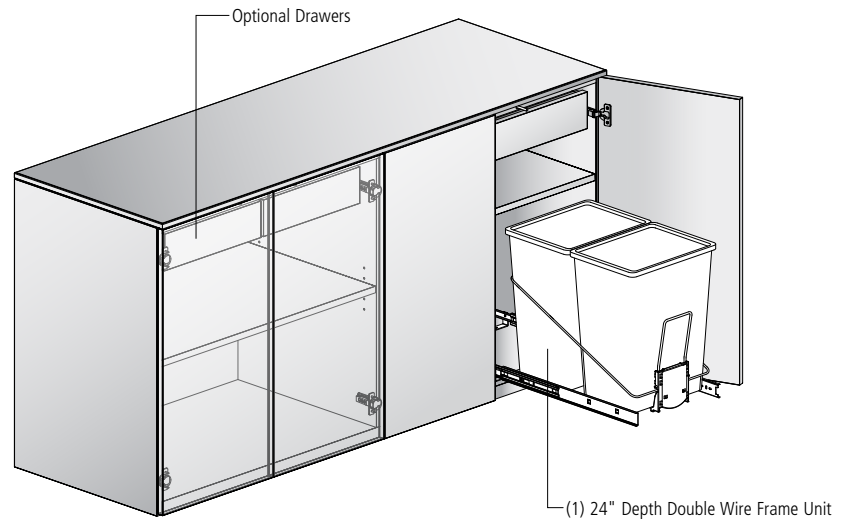

PULL-OUT SINGLE DRAWER REFRIGERATOR

- Available only in 24" depth conference and buffet height credenzas with handle pull
- Includes grain-matched drawer front
- Located in leftmost cabinet, applied to door panel
- Specifications: Summit Appliance

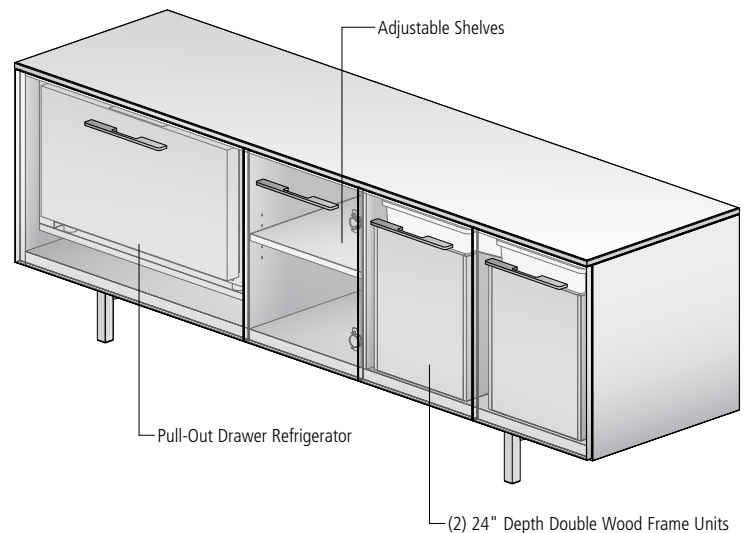

RACKED EQUIPMENT

- Select from sliding or fixed equipment racks
- Equipment racks hold 12RU and include a thermostatically-controlled fan, plugstrip, and a 9"x9" cutout in the back panel behind the rack
- Available on all buffet height and case only conference height credenzas
- Located in the leftmost two-door cabinet

Fixed Equipment Rack

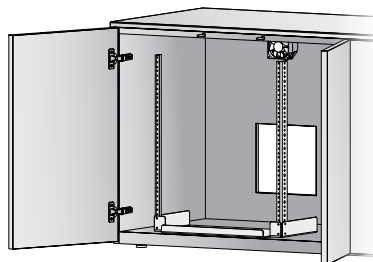

Sliding Equipment Rack

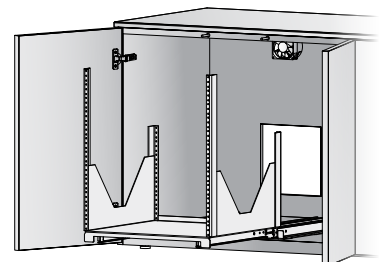



COMPONENT DIMENSIONS

Wire Frame Single Waste/Recycling Unit

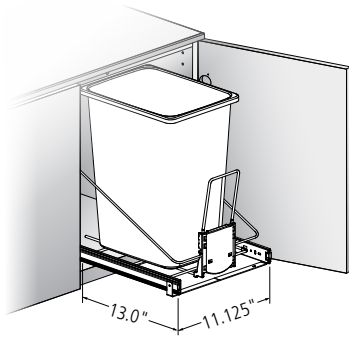

Wire Frame Double Waste/Recycling Unit

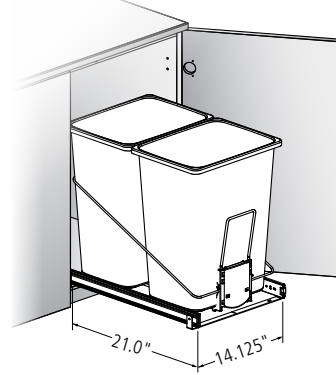

Wood Frame Single Waste/Recycling Unit

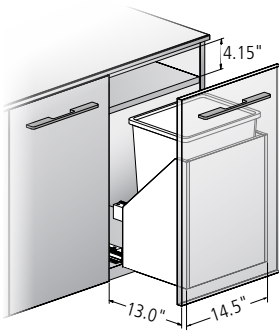

Wood Frame Double Waste/Recycling Unit

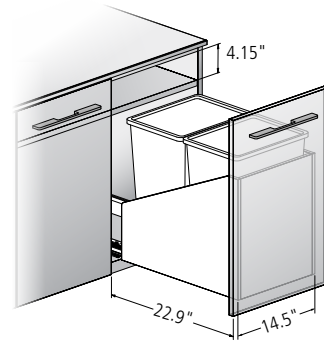

Dual Wire Frame Single Waste/Recycling Unit

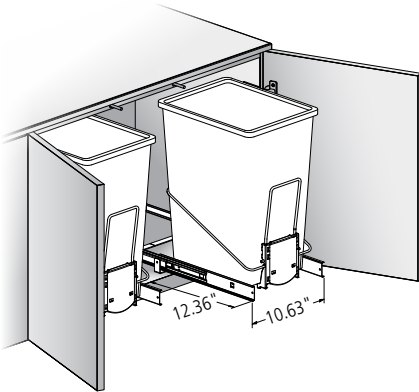

Dual Wire Frame Double Waste/Recycling Unit

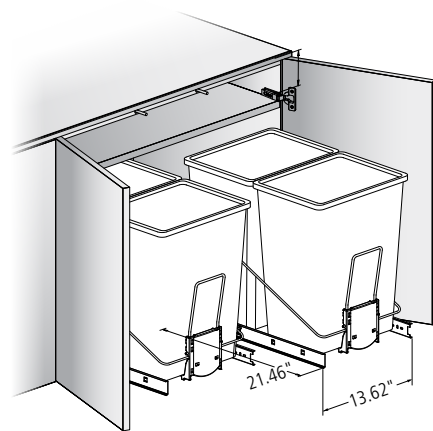

Dual Wood Frame Single Waste/Recycling Unit

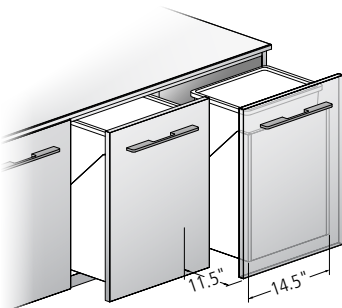

Dual Wood Frame Double Waste/Recycling Unit

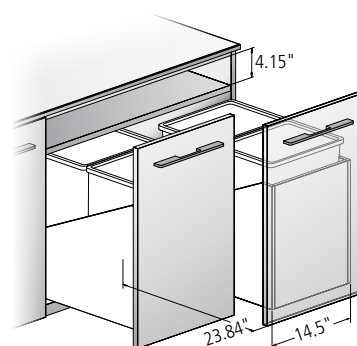



COMPONENT DIMENSIONS

Drawers

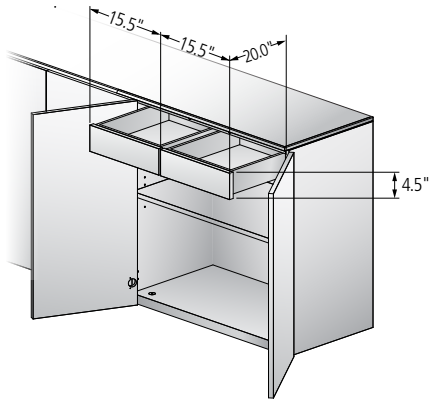

Pull-out Drawer Refrigerator

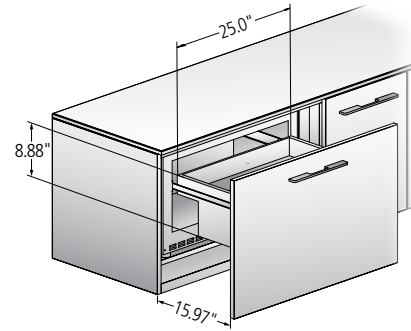

Fixed Equipment Rack

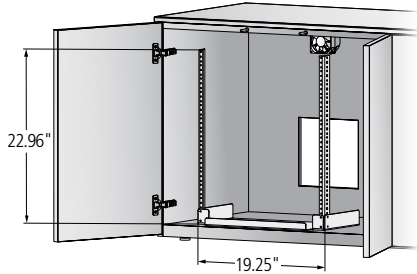

Sliding Equipment Rack

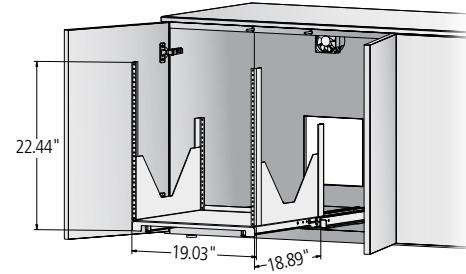



BASE STYLES

CASE

This selection includes a full-size case with .5" adjustable glides.

Case



INSET LEG

Inset metal frame is 1.25" square and 6.5" in height; available in powder coat or polished finish.

Inset Leg

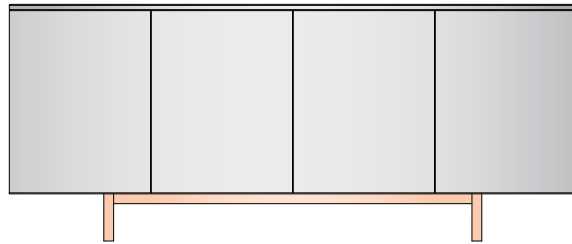

EDGE-MOUNT POST LEG

The edgemount metal post leg is 1.25" square and 6.5" in height; available in powder coat or polished finish. Four post legs located on each corner for 36" – 54" wide credenzas. Two additional legs centered front and back for 72" – 90" wide credenzas.

Edge-mount Post Leg

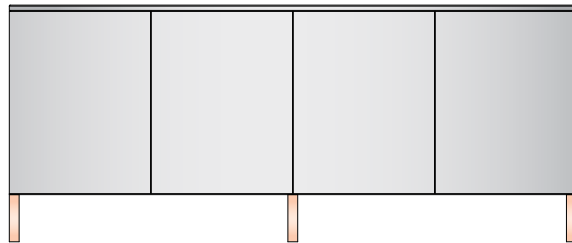

CRADLE BASE

The cradle H-frame is 1.25" square and 6.5" in height; available in powder coat or polished finish. The metal frame runs 10.5" up on each side and runs the length of the credenza.

Cradle Base

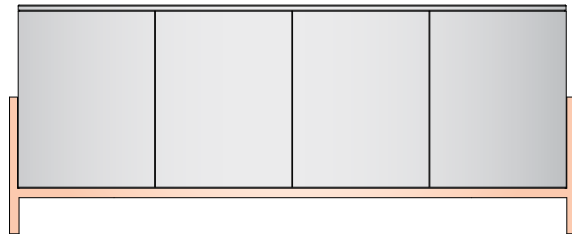

BLADE BASE

The metal blade leg option is .5"-thick, 6" in height, and 14" in length, running the depth of the credenza. Available in powder coat or polished finish.

Blade Base

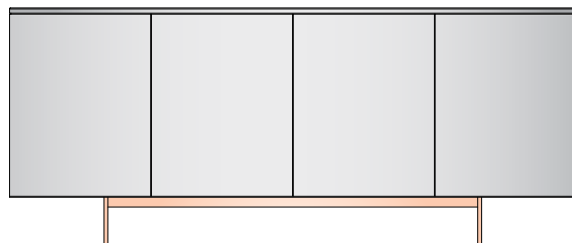



DOOR STYLES

Veneer direction on door interior will be vertical. Veneer case will be vertical slip-match layup regardless of veneer door style selection. Veneer top will run the length of the case. Paint and laminate door interior will match door exterior. Laminate wood grain direction will be vertical on door and case. Case interior will match the case exterior. Laminate wood grain top will run the length of the case.

Vertical Veneer and Woodgrain Laminates

Doors with a vertical veneer direction feature a slip-match layup and are available in all wood finishes.

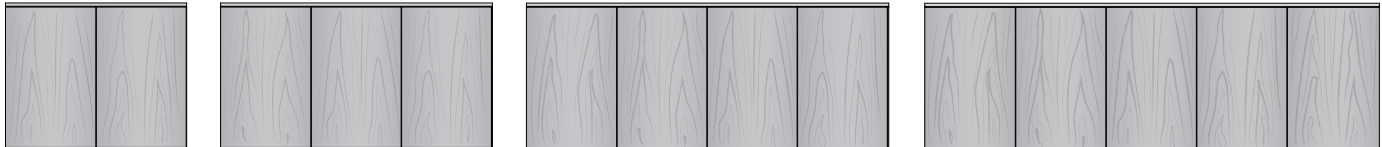

Horizontal Veneer

Doors with a horizontal veneer direction are available in all wood species and finishes. Book-match layup available in Flat Cut Oak, Cherry Linea, Maple and Walnut.

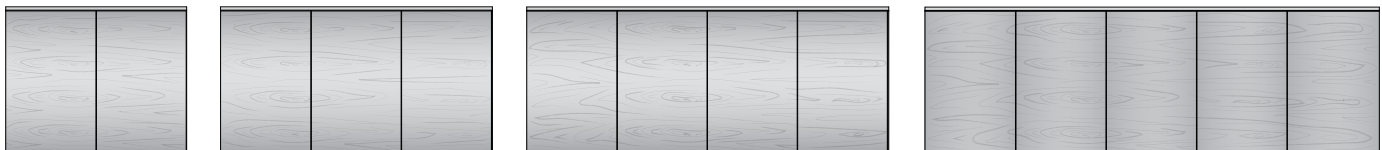

Slip-match layup available in Rift-Cut, Paldao, and Linea.



Painted and Veneer Combinations

Available on all credenzas in any door or base style. If specified, a paint finish must be selected. Case interior will always match the finish of the case exterior.

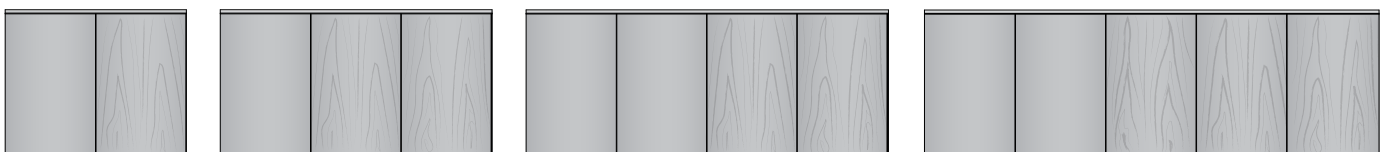



DIMENSIONS: WALL-HUNG AND LOW HEIGHT CREDENZA

DIMENSIONS

All Credenzas 54" and wider include vertical panels that divide the interior into two or three sections depending on credenza width. Dimensions A, B, and C reflect the width of each section.

**Exterior heights exclude top material thickness.
Add top material for total height:**

- Veneer, Laminate and Stone - .75"**
- Glass - .25"**
- Solid Surface - .5"**

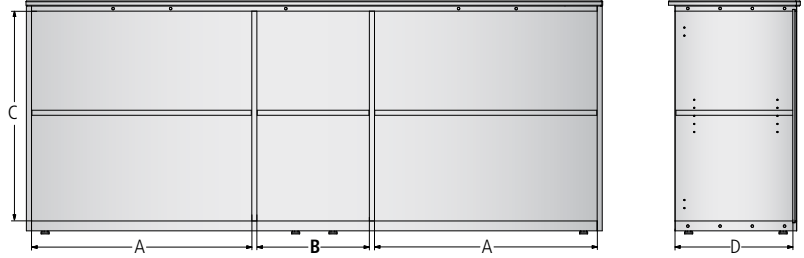

WALL-HUNG CREDENZA



Exterior	Interior Dimensions			
	A	B	C	D
36"W x 20"D x 17.25"H	34.4	-	14.75	18
54"W x 20"D x 17.25"H	34.4	17.2	14.75	18
72"W x 20"D x 17.25"H	34.4	34.4	14.75	18
90"W x 20"D x 17.25"H	34.4	17.6	14.75	18

LOW HEIGHT CREDENZA



Exterior	Case Only; Interior Dimensions				
	A	B	C	D (20")	D (24")
36"W x 20"D x 23.75"H	34.4	-	20.8	18	22
54"W x 20"D x 23.75"H	34.4	17.2	20.8	18	22
72"W x 20"D x 23.75"H	34.4	34.4	20.8	18	22
90"W x 20"D x 23.75"H	34.4	17.6	20.8	18	22

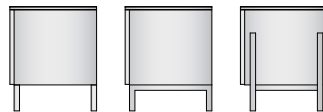

Exterior	Inset Leg, Edge-mount Post Leg, Cradle Base; Interior Dimensions				
	A	B	C	D (20")	D (24")
36"W x 20"D x 29.75"H	34.4	-	14.75	18	22
54"W x 20"D x 29.75"H	34.4	17.2	14.75	18	22
72"W x 20"D x 29.75"H	34.4	34.4	14.75	18	22
90"W x 20"D x 29.75"H	34.4	17.6	14.75	18	22



Exterior	Blade Base; Interior Dimensions				
	A	B	C	D (20")	D (24")
36"W x 20"D x 29.25"H	34.4	-	14.75	18	22
54"W x 20"D x 29.25"H	34.4	17.2	14.75	18	22
72"W x 20"D x 29.25"H	34.4	34.4	14.75	18	22
90"W x 20"D x 29.25"H	34.4	17.6	14.75	18	22



DIMENSIONS: CONFERENCE AND BUFFET HEIGHT CREDENZA

DIMENSIONS

All Credenzas 54" and wider include vertical panels that divide the interior into two or three sections depending on credenza width. Dimensions A, B, and C reflect the width of each section.

**Exterior heights exclude top material thickness.
Add top material for total height:**

- Veneer, Laminate and Stone - .75"**
- Glass - .25"**
- Solid Surface - .5"**

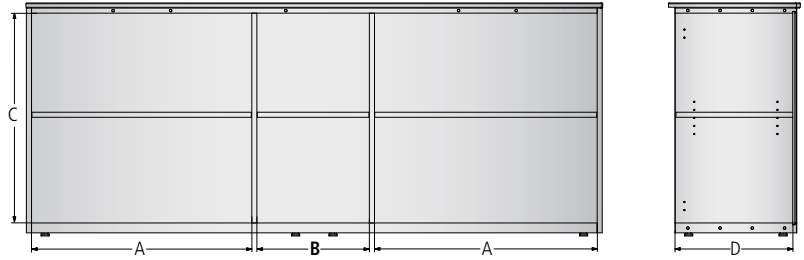

CONFERENCE HEIGHT CREDENZA



Case Only; Interior Dimensions					
Exterior	A	B	C	D (20")	D (24")
36"W x 20"D x 28.75"H	34.4	-	25.8	18	22
54"W x 20"D x 28.75"H	34.4	17.2	25.8	18	22
72"W x 20"D x 28.75"H	34.4	34.4	25.8	18	22
90"W x 20"D x 28.75"H	34.4	17.6	25.8	18	22

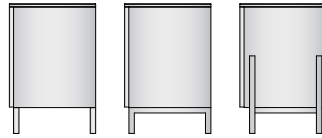

Inset Leg, Edge-mount Post Leg, Cradle Base; Interior Dimensions					
Exterior	A	B	C	D (20")	D (24")
36"W x 20"D x 29.75"H	34.4	-	20.8	18	22
54"W x 20"D x 29.75"H	34.4	17.2	20.8	18	22
72"W x 20"D x 29.75"H	34.4	34.4	20.8	18	22
90"W x 20"D x 29.75"H	34.4	17.6	20.8	18	22



Blade Base; Interior Dimensions					
Exterior	A	B	C	D (20")	D (24")
36"W x 20"D x 29.25"H	34.4	-	20.8	18	22
54"W x 20"D x 29.25"H	34.4	17.2	20.8	18	22
72"W x 20"D x 29.25"H	34.4	34.4	20.8	18	22
90"W x 20"D x 29.25"H	34.4	17.6	20.8	18	22

BUFFET HEIGHT CREDENZA



Case Only; Interior Dimensions					
Exterior	A	B	C	D (20")	D (24")
36"W x 20"D x 35.75"H	34.4	-	32.8	18	22
54"W x 20"D x 35.75"H	34.4	17.2	32.8	18	22
72"W x 20"D x 35.75"H	34.4	34.4	32.8	18	22
90"W x 20"D x 35.75"H	34.4	17.6	32.8	18	22

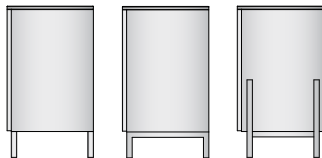

Inset Leg, Edge-mount Post Leg, Cradle Base; Interior Dimensions					
Exterior	A	B	C	D (20")	D (24")
36"W x 20"D x 34.75"H	34.4	-	25.8	18	22
54"W x 20"D x 34.75"H	34.4	17.2	25.8	18	22
72"W x 20"D x 34.75"H	34.4	34.4	25.8	18	22
90"W x 20"D x 34.75"H	34.4	17.6	25.8	18	22



Blade Base; Interior Dimensions					
Exterior	A	B	C	D (20")	D (24")
36"W x 20"D x 34.25"H	34.4	-	25.8	18	22
54"W x 20"D x 34.25"H	34.4	17.2	25.8	18	22
72"W x 20"D x 34.25"H	34.4	34.4	25.8	18	22
90"W x 20"D x 34.25"H	34.4	17.6	25.8	18	22



VENEER TOP WITH HARDWOOD EDGE

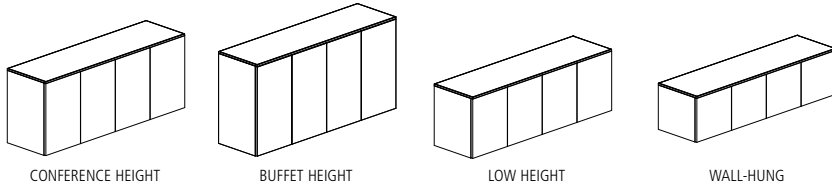

CASE MATERIAL KEY

PA Painted Case
V Veneer Case

CASE ONLY

MODEL #	W x D x H	DESCRIPTION	-PA	-V
CONFERENCE HEIGHT (29.5 INCH CASE)				
FWCC-3629-W	36 x 20 x 29.5	Two Doors	5,716	6,046
FWCC-5429-W	54 x 20 x 29.5	Three Doors	7,439	7,871
FWCC-7229-W	72 x 20 x 29.5	Four Doors	9,164	9,698
FWCC-9029-W	90 x 20 x 29.5	Five Doors	10,890	11,524
FWCD-3629-W	36 x 24 x 29.5	Two Doors	6,284	6,648
FWCD-5429-W	54 x 24 x 29.5	Three Doors	8,182	8,657
FWCD-7229-W	72 x 24 x 29.5	Four Doors	10,083	10,668
FWCD-9029-W	90 x 24 x 29.5	Five Doors	11,977	12,673
BUFFET HEIGHT (36.5 INCH CASE)				
FWBC-3636-W	36 x 20 x 36.5	Two Doors	6,569	6,953
FWBC-5436-W	54 x 20 x 36.5	Three Doors	8,553	9,047
FWBC-7236-W	72 x 20 x 36.5	Four Doors	10,536	11,149
FWBC-9036-W	90 x 20 x 36.5	Five Doors	12,521	13,248
FWBD-3636-W	36 x 24 x 36.5	Two Doors	7,227	7,646
FWBD-5436-W	54 x 24 x 36.5	Three Doors	9,407	9,953
FWBD-7236-W	72 x 24 x 36.5	Four Doors	11,589	12,264
FWBD-9036-W	90 x 24 x 36.5	Five Doors	13,772	14,571
LOW HEIGHT (24.5 INCH CASE)				
FWLC-3624-W	36 x 20 x 24.5	Two Doors	5,292	5,600
FWLC-5424-W	54 x 20 x 24.5	Three Doors	6,889	7,291
FWLC-7224-W	72 x 20 x 24.5	Four Doors	8,487	8,979
FWLC-9024-W	90 x 20 x 24.5	Five Doors	10,085	10,671
FWLD-3624-W	36 x 24 x 24.5	Two Doors	5,821	6,157
FWLD-5424-W	54 x 24 x 24.5	Three Doors	7,577	8,020
FWLD-7224-W	72 x 24 x 24.5	Four Doors	9,333	9,878
FWLD-9024-W	90 x 24 x 24.5	Five Doors	11,091	11,733
WALL-HUNG (18 INCH CASE)				
FWWC-3618-W	36 x 20 x 18	Two Doors	4,858	5,141
FWWC-5418-W	54 x 20 x 18	Three Doors	6,326	6,692
FWWC-7218-W	72 x 20 x 18	Four Doors	7,791	8,241
FWWC-9018-W	90 x 20 x 18	Five Doors	9,257	9,793

DOOR STYLE

DESCRIPTION	CODE	NOTES	PRICE
Vertical Veneer	-VD		No Charge
Horizontal Veneer	-HD		No Charge
Veneer/Paint Combination	-VPD	Reference page 8 for predetermined accent door locations	No Charge
Painted	-PAD		No Charge

PULL STYLE

DESCRIPTION	CODE	NOTES	TWO DOOR	THREE DOOR	FOUR DOOR	FIVE DOOR
Push Latch	No Code	Push to open (no pull). Applied to all doors.	No Charge	No Charge	No Charge	No Charge
Handle Pull - Powder Coat	-HP	Pull to open. Applied to all doors.	\$157	\$236	\$314	\$392
Handle Pull - High Polish Finish	-HP-HPF	Pull to open. Applied to all doors.	\$277	\$416	\$554	\$693
Handle Pull - Clear Anodized	-HP-CA	Pull to open. Applied to all doors.	\$157	\$236	\$314	\$392
Handle Pull - Goldmatt Anodized	-HP-GMA	Pull to open. Applied to all doors.	\$230	\$345	\$460	\$575
Handle Pull - Antique Brass Anodized	-HP-ABA	Pull to open. Applied to all doors.	\$230	\$345	\$460	\$575
Handle Pull - Light Bronze Anodized	-HP-LBA	Pull to open. Applied to all doors.	\$230	\$345	\$460	\$575



VENEER TOP WITH HARDWOOD EDGE

PUSH LATCH OR HANDLE PULL OPTIONS	CODE	PRICE	NOTES
Locks	Add -LK	\$315	Locks included in all cabinets
Drawers Behind Doors	Add -D	\$614	Available on Buffet Height Credenza
Wire Frame Pull-Out Waste/Recycling Unit Conference, Buffet, and Low Height Credenzas (excludes 36" width)			
(1) 20" Depth Single Wire Frame Unit	Add -TF1	\$309	Located in the rightmost cabinet, behind the right door
(1) 24" Depth Double Wire Frame Unit	Add -TF2	\$477	Located in the rightmost cabinet, behind the right door
Dual Wire Frame Pull-Out Waste/Recycling Units Conference, Buffet, and Low Height Credenzas (Excludes 36"-54" width)			
(2) 20" Depth Single Wire Frame Units	Add -TF3	\$617	Located in the rightmost cabinet, behind left and right doors
(2) 24" Depth Double Wire Frame Units	Add -TF4	\$954	Located in the rightmost cabinet, behind left and right doors
24" Depth Equipment Rack Options Available on Conference and Buffet Height Credenzas			
Fixed Equipment Rack	Add -R2	\$947	Located in left most cabinet, behind left and right doors
Sliding Equipment Rack	Add -R1	\$3,467	Located in left most cabinet, behind left and right doors

ADDITIONAL HANDLE PULL OPTIONS

Wood Frame Pull-Out Waste/Recycling Bin Unit Conference, Buffet, and Low Height Credenzas (Excludes 36" width)			
(1) 20" Depth Single Wood Frame Unit	Add -FWTF1	\$817	Located in the rightmost cabinet, applied to right door
(1) 24" Depth Double Wood Frame Unit	Add -FWTF2	\$1,225	Located in the rightmost cabinet, applied to right door
Dual Wood Frame Pull-Out Waste/Recycling Bin Unit Conference, Buffet, and Low Height Credenzas (Excludes 36"-54" width)			
(2) 20" Depth Single Wood Frame Units	Add -FWTF3	\$1,633	Located in the rightmost cabinet, applied to left and right doors
(2) 24" Depth Double Wood Frame Units	Add -FWTF4	\$2,450	Located in the rightmost cabinet, applied to left and right doors
24" Depth Single Pull-Out Drawer Refrigerator Available on Conference and Low Height Credenzas			
Pull-Out Drawer Refrigerator	Add -FWOM24	\$7,327	Located in left most cabinet, includes applied door panel

EDGE PROFILE



Square Edge

REQUIRED INFORMATION (ORDER CANNOT BE ENTERED WITHOUT THIS INFORMATION)

See appendix pages vi-viii for surface material options.

- Choose Door Style: Defaults to case finish, if none selected
- Choose Pull Style: Defaults to Push Latch, if none selected
- Choose Veneer Finish
- Choose Paint Finish, if specified

GENERAL INFORMATION

- Tops are 3/4" -thick with 3/16"-deep hardwood edge band
- When veneer case is specified, the case exterior is standard slip-match layup regardless of veneer door style selection
- Pull-Out Waste/Recycling Bin size: 17-7/8" x 8-3/32" x 11-9/16"; (1) 35 Qt.; Double Pull-Out Waste/Recycling Units include two bins
- Locks
 - Veneer (Case Only) - When lock option is specified, color will default to Satin Nickel
 - Painted (Case Only) - When lock option is specified, color will default based on Paint finish:
 - Aged Bronze, Black, Galaxy, Shadow, and Storm: Black
 - Cloud: White
 - Burnish, Foil, Satin Bronze: Satin Nickel
 - Chrome: Polished Nickel
- Credenzas include one adjustable shelf behind each door unless other components are specified
- Equipment racks hold 12RU and include a thermostatically controlled fan and plug strip



VENEER TOP WITH HARDWOOD EDGE

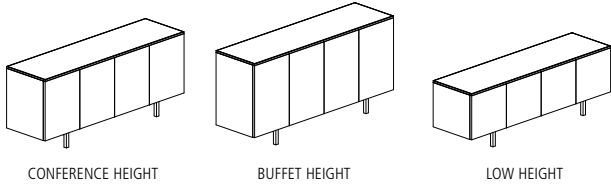

CASE MATERIAL KEY

PA-IB Painted Case with Inset Leg
 V-IB Veneer Case with Inset Leg

INSET LEG

MODEL #	W x D x H	DESCRIPTION	-PA-IB	-V-IB
CONFERENCE HEIGHT (24 IN. CASE WITH 6.5 IN. INSET LEG)				
FWLC-3629-W	36 x 20 x 30.5	Two Doors	5,758	6,065
FWLC-5429-W	54 x 20 x 30.5	Three Doors	7,355	7,755
FWLC-7229-W	72 x 20 x 30.5	Four Doors	8,948	9,446
FWLC-9029-W	90 x 20 x 30.5	Five Doors	10,550	11,135
FWLD-3629-W	36 x 24 x 30.5	Two Doors	6,284	6,622
FWLD-5429-W	54 x 24 x 30.5	Three Doors	8,042	8,486
FWLD-7229-W	72 x 24 x 30.5	Four Doors	9,798	10,343
FWLD-9029-W	90 x 24 x 30.5	Five Doors	11,557	12,200
BUFFET HEIGHT (29 IN. CASE WITH 6.5 IN. INSET LEG)				
FWCC-3636-W	36 x 20 x 35.5	Two Doors	6,180	6,509
FWCC-5436-W	54 x 20 x 35.5	Three Doors	7,904	8,336
FWCC-7236-W	72 x 20 x 35.5	Four Doors	9,630	10,161
FWCC-9036-W	90 x 20 x 35.5	Five Doors	11,354	11,987
FWCD-3636-W	36 x 24 x 35.5	Two Doors	6,751	7,112
FWCD-5436-W	54 x 24 x 35.5	Three Doors	8,646	9,125
FWCD-7236-W	72 x 24 x 35.5	Four Doors	10,545	11,131
FWCD-9036-W	90 x 24 x 35.5	Five Doors	12,442	13,138
LOW HEIGHT (18 IN. CASE WITH 6.5 IN. INSET LEG)				
FWWC-3624-W	36 x 20 x 24.5	Two Doors	5,325	5,608
FWWC-5424-W	54 x 20 x 24.5	Three Doors	6,792	7,159
FWWC-7224-W	72 x 20 x 24.5	Four Doors	8,255	8,706
FWWC-9024-W	90 x 20 x 24.5	Five Doors	9,724	10,259

DOOR STYLE

DESCRIPTION	CODE	NOTES	PRICE
Vertical Veneer	-VD		No Charge
Horizontal Veneer	-HD		No Charge
Veneer/Paint Combination	-VPD	Reference page 8 for predetermined accent door locations	No Charge
Painted	-PAD		No Charge

PULL STYLE

DESCRIPTION	CODE	NOTES	TWO DOOR	THREE DOOR	FOUR DOOR	FIVE DOOR
Push Latch	No Code	Push to open (no pull). Applied to all doors.	No Charge	No Charge	No Charge	No Charge
Handle Pull - Powder Coat	-HP	Pull to open. Applied to all doors.	\$157	\$236	\$314	\$392
Handle Pull - High Polish Finish	-HP-HPF	Pull to open. Applied to all doors.	\$277	\$416	\$554	\$693
Handle Pull - Clear Anodized	-HP-CA	Pull to open. Applied to all doors.	\$157	\$236	\$314	\$392
Handle Pull - Goldmatt Anodized	-HP-GMA	Pull to open. Applied to all doors.	\$230	\$345	\$460	\$575
Handle Pull - Antique Brass Anodized	-HP-ABA	Pull to open. Applied to all doors.	\$230	\$345	\$460	\$575
Handle Pull - Light Bronze Anodized	-HP-LBA	Pull to open. Applied to all doors.	\$230	\$345	\$460	\$575



VENEER TOP WITH HARDWOOD EDGE

PUSH LATCH OR HANDLE PULL OPTIONS	CODE	PRICE	NOTES
Locks	Add -LK	\$315	Locks included in all cabinets
Polished Chrome Base	Add -PCIB	\$501	
Wire Frame Pull-Out Waste/Recycling Unit Conference and Buffet Height Credenzas (excludes 36" width)			
(1) 20" Depth Single Wire Frame Unit	Add -TF1	\$309	Located in the rightmost cabinet, behind the right door
(1) 24" Depth Double Wire Frame Unit	Add -TF2	\$477	Located in the rightmost cabinet, behind the right door
Dual Wire Frame Pull-Out Waste/Recycling Units Conference and Buffet Height Credenzas (Excludes 36"-54" width)			
(2) 20" Depth Single Wire Frame Units	Add -TF3	\$617	Located in the rightmost cabinet, behind left and right doors
(2) 24" Depth Double Wire Frame Units	Add -TF4	\$954	Located in the rightmost cabinet, behind left and right doors
24" Depth Equipment Rack Options Available on Buffet Height Credenzas			
Fixed Equipment Rack	Add -R2	\$947	Located in left most cabinet, behind left and right doors
Sliding Equipment Rack	Add -R1	\$3,467	Located in left most cabinet, behind left and right doors

ADDITIONAL HANDLE PULL OPTIONS

Wood Frame Pull-Out Waste/Recycling Bin Unit Conference and Buffet Height Credenzas (Excludes 36" width)			
(1) 20" Depth Single Wood Frame Unit	Add -FWTF1	\$817	Located in the rightmost cabinet, applied to right door
(1) 24" Depth Double Wood Frame Unit	Add -FWTF2	\$1,225	Located in the rightmost cabinet, applied to right door
Dual Wood Frame Pull-Out Waste/Recycling Bin Unit Conference and Buffet Height Credenzas (Excludes 36"-54" width)			
(2) 20" Depth Single Wood Frame Units	Add -FWTF3	\$1,633	Located in the rightmost cabinet, applied to left and right doors
(2) 24" Depth Double Wood Frame Units	Add -FWTF4	\$2,450	Located in the rightmost cabinet, applied to left and right doors
24" Depth Single Pull-Out Drawer Refrigerator Available on Conference and Buffet Height Credenzas			
Pull-Out Drawer Refrigerator	Add -FWOM24	\$7,327	Located in left most cabinet, includes applied door panel

EDGE PROFILE



Square Edge

REQUIRED INFORMATION (ORDER CANNOT BE ENTERED WITHOUT THIS INFORMATION)

See appendix pages vi-viii for surface material options.

- Choose Door Style: Defaults to case finish, if none selected
- Choose Pull Style: Defaults to Push Latch, if none selected
- Choose Metal Finish
- Choose Veneer Finish
- Choose Paint Finish, if specified

GENERAL INFORMATION

- Tops are 3/4"-thick with 3/16"-deep hardwood edge band
- When veneer case is specified, the case exterior is standard slip-match layup regardless of veneer door style selection
- Pull-Out Waste/Recycling Bin size: 17-7/8" x 8-3/32" x 11-9/16"; (1) 35 Qt.; Double Pull-Out Waste/Recycling Units include two bins
- When lock option is specified, color will default based on leg finish:
 - Aged Bronze, Black, Galaxy, Shadow, and Storm: Black
 - Cloud: White
 - Burnish, Foil, and Satin Bronze: Satin Nickel
 - Chrome: Polished Nickel
- Credenzas include one adjustable shelf behind each door unless other components are specified
- Equipment racks hold 12RU and include a thermostatically controlled fan and plug strip



VENEER TOP WITH HARDWOOD EDGE

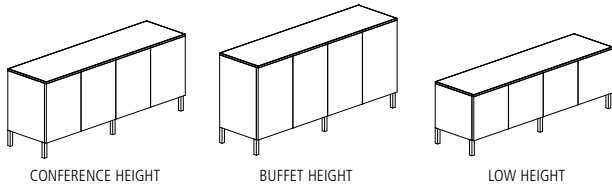

CASE MATERIAL KEY

PA-OB Painted Case with Edge-mount Post Leg
 V-OB Veneer Case with Edge-mount Post Leg

EDGE-MOUNT POST LEG

MODEL #	W x D x H	DESCRIPTION	-PA-OB	-V-OB
CONFERENCE HEIGHT (24 IN. CASE WITH 6.5 IN. EDGE-MOUNT POST LEG)				
FWLC-3629-W	36 x 20 x 30.5	Two Doors	5,758	6,065
FWLC-5429-W	54 x 20 x 30.5	Three Doors	7,355	7,755
FWLC-7229-W	72 x 20 x 30.5	Four Doors	8,948	9,446
FWLC-9029-W	90 x 20 x 30.5	Five Doors	10,550	11,135
FWLD-3629-W	36 x 24 x 30.5	Two Doors	6,284	6,622
FWLD-5429-W	54 x 24 x 30.5	Three Doors	8,042	8,486
FWLD-7229-W	72 x 24 x 30.5	Four Doors	9,798	10,343
FWLD-9029-W	90 x 24 x 30.5	Five Doors	11,557	12,200
BUFFET HEIGHT (29 IN. CASE WITH 6.5 IN. EDGE-MOUNT POST LEG)				
FWCC-3636-W	36 x 20 x 35.5	Two Doors	6,180	6,509
FWCC-5436-W	54 x 20 x 35.5	Three Doors	7,904	8,336
FWCC-7236-W	72 x 20 x 35.5	Four Doors	9,630	10,161
FWCC-9036-W	90 x 20 x 35.5	Five Doors	11,354	11,987
FWCD-3636-W	36 x 24 x 35.5	Two Doors	6,751	7,112
FWCD-5436-W	54 x 24 x 35.5	Three Doors	8,646	9,125
FWCD-7236-W	72 x 24 x 35.5	Four Doors	10,545	11,131
FWCD-9036-W	90 x 24 x 35.5	Five Doors	12,442	13,138
LOW HEIGHT (18 IN. CASE WITH 6.5 IN. EDGE-MOUNT POST LEG)				
FWWC-3624-W	36 x 20 x 24.5	Two Doors	5,325	5,608
FWWC-5424-W	54 x 20 x 24.5	Three Doors	6,792	7,159
FWWC-7224-W	72 x 20 x 24.5	Four Doors	8,255	8,706
FWWC-9024-W	90 x 20 x 24.5	Five Doors	9,724	10,259

DOOR STYLE

DESCRIPTION	CODE	NOTES	PRICE
Vertical Veneer	-VD		No Charge
Horizontal Veneer	-HD		No Charge
Veneer/Paint Combination	-VPD	Reference page 8 for predetermined accent door locations	No Charge
Painted	-PAD		No Charge

PULL STYLE

DESCRIPTION	CODE	NOTES	TWO DOOR	THREE DOOR	FOUR DOOR	FIVE DOOR
Push Latch	No Code	Push to open (no pull). Applied to all doors.	No Charge	No Charge	No Charge	No Charge
Handle Pull - Powder Coat	-HP	Pull to open. Applied to all doors.	\$157	\$236	\$314	\$392
Handle Pull - High Polish Finish	-HP-HPF	Pull to open. Applied to all doors.	\$277	\$416	\$554	\$693
Handle Pull - Clear Anodized	-HP-CA	Pull to open. Applied to all doors.	\$157	\$236	\$314	\$392
Handle Pull - Goldmatt Anodized	-HP-GMA	Pull to open. Applied to all doors.	\$230	\$345	\$460	\$575
Handle Pull - Antique Brass Anodized	-HP-ABA	Pull to open. Applied to all doors.	\$230	\$345	\$460	\$575
Handle Pull - Light Bronze Anodized	-HP-LBA	Pull to open. Applied to all doors.	\$230	\$345	\$460	\$575



VENEER TOP WITH HARDWOOD EDGE

PUSH LATCH OR HANDLE PULL OPTIONS	CODE	PRICE	NOTES
Locks	Add -LK	\$315	Locks included in all cabinets
Polished Chrome Base	Add -PCOB	\$541	
Wire Frame Pull-Out Waste/Recycling Unit Conference and Buffet Height Credenzas (excludes 36" width)			
(1) 20" Depth Single Wire Frame Unit	Add -TF1	\$309	Located in the rightmost cabinet, behind the right door
(1) 24" Depth Double Wire Frame Unit	Add -TF2	\$477	Located in the rightmost cabinet, behind the right door
Dual Wire Frame Pull-Out Waste/Recycling Units Conference and Buffet Height Credenzas (Excludes 36"-54" width)			
(2) 20" Depth Single Wire Frame Units	Add -TF3	\$617	Located in the rightmost cabinet, behind left and right doors
(2) 24" Depth Double Wire Frame Units	Add -TF4	\$954	Located in the rightmost cabinet, behind left and right doors
24" Depth Equipment Rack Options Available on Buffet Height Credenzas			
Fixed Equipment Rack	Add -R2	\$947	Located in left most cabinet, behind left and right doors
Sliding Equipment Rack	Add -R1	\$3,467	Located in left most cabinet, behind left and right doors

ADDITIONAL HANDLE PULL OPTIONS

Wood Frame Pull-Out Waste/Recycling Bin Unit Conference and Buffet Height Credenzas (Excludes 36" width)			
(1) 20" Depth Single Wood Frame Unit	Add -FWTF1	\$817	Located in the rightmost cabinet, applied to right door
(1) 24" Depth Double Wood Frame Unit	Add -FWTF2	\$1,225	Located in the rightmost cabinet, applied to right door
Dual Wood Frame Pull-Out Waste/Recycling Bin Unit Conference and Buffet Height Credenzas (Excludes 36"-54" width)			
(2) 20" Depth Single Wood Frame Units	Add -FWTF3	\$1,633	Located in the rightmost cabinet, applied to left and right doors
(2) 24" Depth Double Wood Frame Units	Add -FWTF4	\$2,450	Located in the rightmost cabinet, applied to left and right doors
24" Depth Single Pull-Out Drawer Refrigerator Available on Conference and Buffet Height Credenzas			
Pull-Out Drawer Refrigerator	Add -FWOM24	\$7,327	Located in left most cabinet, includes applied door panel

EDGE PROFILE



Square Edge

REQUIRED INFORMATION (ORDER CANNOT BE ENTERED WITHOUT THIS INFORMATION)

See appendix pages vi-viii for surface material options.

- Choose Door Style: Defaults to case finish, if none selected
- Choose Pull Style: Defaults to Push Latch, if none selected
- Choose Metal Finish
- Choose Veneer Finish
- Choose Paint Finish, if specified

GENERAL INFORMATION

- Tops are 3/4"-thick with 3/16"-deep hardwood edge band
- When veneer case is specified, the case exterior is standard slip-match layup regardless of veneer door style selection
- Pull-Out Waste/Recycling Bin size: 17-7/8" x 8-3/32" x 11-9/16"; (1) 35 Qt.; Double Pull-Out Waste/Recycling Units include two bins
- When lock option is specified, color will default based on leg finish:
 - Aged Bronze, Black, Galaxy, Shadow, and Storm: Black
 - Cloud: White
 - Burnish, Foil, and Satin Bronze: Satin Nickel
 - Chrome: Polished Nickel
- Credenzas include one adjustable shelf behind each door unless other components are specified
- Equipment racks hold 12RU and include a thermostatically controlled fan and plug strip



VENEER TOP WITH HARDWOOD EDGE

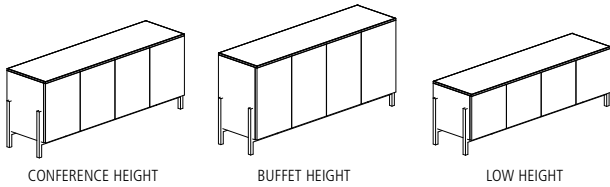

CASE MATERIAL KEY

PA-CB Painted Case with Cradle Base
 V-CB Veneer Case with Cradle Base

CRADLE BASE

MODEL #	W x D x H	DESCRIPTION	-PA-CB	-V-CB
CONFERENCE HEIGHT (24 IN. CASE WITH 6.5 IN. CRADLE BASE)				
FWLC-3629-W	36 x 20 x 30.5	Two Doors	6,377	6,682
FWLC-5429-W	54 x 20 x 30.5	Three Doors	7,974	8,373
FWLC-7229-W	72 x 20 x 30.5	Four Doors	9,573	10,065
FWLC-9029-W	90 x 20 x 30.5	Five Doors	11,171	11,755
FWLD-3629-W	36 x 24 x 30.5	Two Doors	6,905	7,241
FWLD-5429-W	54 x 24 x 30.5	Three Doors	8,663	9,106
FWLD-7229-W	72 x 24 x 30.5	Four Doors	10,417	10,964
FWLD-9029-W	90 x 24 x 30.5	Five Doors	12,177	12,817
BUFFET HEIGHT (29 IN. CASE WITH 6.5 IN. CRADLE BASE)				
FWCC-3636-W	36 x 20 x 35.5	Two Doors	6,800	7,129
FWCC-5436-W	54 x 20 x 35.5	Three Doors	8,522	8,958
FWCC-7236-W	72 x 20 x 35.5	Four Doors	10,250	10,784
FWCC-9036-W	90 x 20 x 35.5	Five Doors	11,974	12,606
FWCD-3636-W	36 x 24 x 35.5	Two Doors	7,370	7,732
FWCD-5436-W	54 x 24 x 35.5	Three Doors	9,268	9,744
FWCD-7236-W	72 x 24 x 35.5	Four Doors	11,163	11,752
FWCD-9036-W	90 x 24 x 35.5	Five Doors	13,065	13,759
LOW HEIGHT (18 IN. CASE WITH 6.5 IN. CRADLE BASE)				
FWWC-3624-W	36 x 20 x 24.5	Two Doors	5,943	6,228
FWWC-5424-W	54 x 20 x 24.5	Three Doors	7,411	7,778
FWWC-7224-W	72 x 20 x 24.5	Four Doors	8,875	9,328
FWWC-9024-W	90 x 20 x 24.5	Five Doors	10,343	10,880

DOOR STYLE

DESCRIPTION	CODE	NOTES	PRICE
Vertical Veneer	-VD		No Charge
Horizontal Veneer	-HD		No Charge
Veneer/Paint Combination	-VPD	Reference page 8 for predetermined accent door locations	No Charge
Painted	-PAD		No Charge

PULL STYLE

DESCRIPTION	CODE	NOTES	TWO DOOR	THREE DOOR	FOUR DOOR	FIVE DOOR
Push Latch	No Code	Push to open (no pull). Applied to all doors.	No Charge	No Charge	No Charge	No Charge
Handle Pull - Powder Coat	-HP	Pull to open. Applied to all doors.	\$157	\$236	\$314	\$392
Handle Pull - High Polish Finish	-HP-HPF	Pull to open. Applied to all doors.	\$277	\$416	\$554	\$693
Handle Pull - Clear Anodized	-HP-CA	Pull to open. Applied to all doors.	\$157	\$236	\$314	\$392
Handle Pull - Goldmatt Anodized	-HP-GMA	Pull to open. Applied to all doors.	\$230	\$345	\$460	\$575
Handle Pull - Antique Brass Anodized	-HP-ABA	Pull to open. Applied to all doors.	\$230	\$345	\$460	\$575
Handle Pull - Light Bronze Anodized	-HP-LBA	Pull to open. Applied to all doors.	\$230	\$345	\$460	\$575



VENEER TOP WITH HARDWOOD EDGE

PUSH LATCH OR HANDLE PULL OPTIONS	CODE	PRICE	NOTES
Locks	Add -LK	\$315	Locks included in all cabinets
Polished Chrome Base	Add -PCCB	\$1,775	
Wire Frame Pull-Out Waste/Recycling Unit Conference and Buffet Height Credenzas (excludes 36" width)			
(1) 20" Depth Single Wire Frame Unit	Add -TF1	\$309	Located in the rightmost cabinet, behind the right door
(1) 24" Depth Double Wire Frame Unit	Add -TF2	\$477	Located in the rightmost cabinet, behind the right door
Dual Wire Frame Pull-Out Waste/Recycling Units Conference and Buffet Height Credenzas (Excludes 36"-54" width)			
(2) 20" Depth Single Wire Frame Units	Add -TF3	\$617	Located in the rightmost cabinet, behind left and right doors
(2) 24" Depth Double Wire Frame Units	Add -TF4	\$954	Located in the rightmost cabinet, behind left and right doors
24" Depth Equipment Rack Options Available on Buffet Height Credenzas			
Fixed Equipment Rack	Add -R2	\$947	Located in left most cabinet, behind left and right doors
Sliding Equipment Rack	Add -R1	\$3,467	Located in left most cabinet, behind left and right doors

ADDITIONAL HANDLE PULL OPTIONS

Wood Frame Pull-Out Waste/Recycling Bin Unit Conference and Buffet Height Credenzas (Excludes 36" width)			
(1) 20" Depth Single Wood Frame Unit	Add -FWTF1	\$817	Located in the rightmost cabinet, applied to right door
(1) 24" Depth Double Wood Frame Unit	Add -FWTF2	\$1,225	Located in the rightmost cabinet, applied to right door
Dual Wood Frame Pull-Out Waste/Recycling Bin Unit Conference and Buffet Height Credenzas (Excludes 36"-54" width)			
(2) 20" Depth Single Wood Frame Units	Add -FWTF3	\$1,633	Located in the rightmost cabinet, applied to left and right doors
(2) 24" Depth Double Wood Frame Units	Add -FWTF4	\$2,450	Located in the rightmost cabinet, applied to left and right doors
24" Depth Single Pull-Out Drawer Refrigerator Available on Conference and Buffet Height Credenzas			
Pull-Out Drawer Refrigerator	Add -FWOM24	\$7,327	Located in left most cabinet, includes applied door panel

EDGE PROFILE



Square Edge

REQUIRED INFORMATION (ORDER CANNOT BE ENTERED WITHOUT THIS INFORMATION)

See appendix pages vi-viii for surface material options.

- Choose Door Style: Defaults to case finish, if none selected
- Choose Pull Style: Defaults to Push Latch, if none selected
- Choose Metal Finish
- Choose Veneer Finish
- Choose Paint Finish, if specified

GENERAL INFORMATION

- Tops are 3/4"-thick with 3/16"-deep hardwood edge band
- When veneer case is specified, the case exterior is standard slip-match layup regardless of veneer door style selection
- Pull-Out Waste/Recycling Bin size: 17-7/8" x 8-3/32" x 11-9/16"; (1) 35 Qt.; Double Pull-Out Waste/Recycling Units include two bins
- When lock option is specified, color will default based on leg finish:
 - Aged Bronze, Black, Galaxy, Shadow, and Storm: Black
 - Cloud: White
 - Burnish, Foil, and Satin Bronze: Satin Nickel
 - Chrome: Polished Nickel
- Credenzas include one adjustable shelf behind each door unless other components are specified
- Equipment racks hold 12RU and include a thermostatically controlled fan and plug strip



VENEER TOP WITH HARDWOOD EDGE

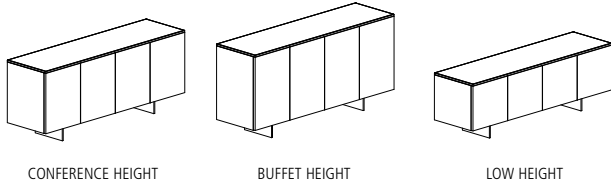

CASE MATERIAL KEY

PA-BB Painted Case with Blade Base
 V-BB Veneer Case with Blade Base

BLADE BASE

MODEL #	W x D x H	DESCRIPTION	-PA-BB	-V-BB
CONFERENCE HEIGHT (24 IN. CASE WITH 6.5 IN. BLADE BASE)				
FWLC-3629-W	36 x 20 x 30	Two Doors	6,067	6,375
FWLC-5429-W	54 x 20 x 30	Three Doors	7,662	8,063
FWLC-7229-W	72 x 20 x 30	Four Doors	9,259	9,757
FWLC-9029-W	90 x 20 x 30	Five Doors	10,859	11,444
FWLD-3629-W	36 x 24 x 30	Two Doors	6,595	6,933
FWLD-5429-W	54 x 24 x 30	Three Doors	8,351	8,793
FWLD-7229-W	72 x 24 x 30	Four Doors	10,108	10,654
FWLD-9029-W	90 x 24 x 30	Five Doors	11,865	12,510
BUFFET HEIGHT (29 IN. CASE WITH 6.5 IN. BLADE BASE)				
FWCC-3636-W	36 x 20 x 35	Two Doors	6,491	6,820
FWCC-5436-W	54 x 20 x 35	Three Doors	8,214	8,646
FWCC-7236-W	72 x 20 x 35	Four Doors	9,942	10,471
FWCC-9036-W	90 x 20 x 35	Five Doors	11,665	12,297
FWCD-3636-W	36 x 24 x 35	Two Doors	7,062	7,423
FWCD-5436-W	54 x 24 x 35	Three Doors	8,958	9,434
FWCD-7236-W	72 x 24 x 35	Four Doors	10,856	11,441
FWCD-9036-W	90 x 24 x 35	Five Doors	12,755	13,449
LOW HEIGHT (18 IN. CASE WITH 6.5 IN. BLADE BASE)				
FWWC-3624-W	36 x 20 x 24	Two Doors	5,636	5,916
FWWC-5424-W	54 x 20 x 24	Three Doors	7,103	7,469
FWWC-7224-W	72 x 20 x 24	Four Doors	8,566	9,018
FWWC-9024-W	90 x 20 x 24	Five Doors	10,032	10,568

DOOR STYLE

DESCRIPTION	CODE	NOTES	PRICE
Vertical Veneer	-VD		No Charge
Horizontal Veneer	-HD		No Charge
Veneer/Paint Combination	-VPD	Reference page 8 for predetermined accent door locations	No Charge
Painted	-PAD		No Charge

PULL STYLE

DESCRIPTION	CODE	NOTES	TWO DOOR	THREE DOOR	FOUR DOOR	FIVE DOOR
Push Latch	No Code	Push to open (no pull). Applied to all doors.	No Charge	No Charge	No Charge	No Charge
Handle Pull - Powder Coat	-HP	Pull to open. Applied to all doors.	\$157	\$236	\$314	\$392
Handle Pull - High Polish Finish	-HP-HPF	Pull to open. Applied to all doors.	\$277	\$416	\$554	\$693
Handle Pull - Clear Anodized	-HP-CA	Pull to open. Applied to all doors.	\$157	\$236	\$314	\$392
Handle Pull - Goldmatt Anodized	-HP-GMA	Pull to open. Applied to all doors.	\$230	\$345	\$460	\$575
Handle Pull - Antique Brass Anodized	-HP-ABA	Pull to open. Applied to all doors.	\$230	\$345	\$460	\$575
Handle Pull - Light Bronze Anodized	-HP-LBA	Pull to open. Applied to all doors.	\$230	\$345	\$460	\$575



VENEER TOP WITH HARDWOOD EDGE

PUSH LATCH OR HANDLE PULL OPTIONS	CODE	PRICE	NOTES
Locks	Add -LK	\$315	Locks included in all cabinets
Polished Chrome Base	Add -PCBB	\$501	
Wire Frame Pull-Out Waste/Recycling Unit Conference and Buffet Height Credenzas (excludes 36" width)			
(1) 20" Depth Single Wire Frame Unit	Add -TF1	\$309	Located in the rightmost cabinet, behind the right door
(1) 24" Depth Double Wire Frame Unit	Add -TF2	\$477	Located in the rightmost cabinet, behind the right door
Dual Wire Frame Pull-Out Waste/Recycling Units Conference and Buffet Height Credenzas (Excludes 36"-54" width)			
(2) 20" Depth Single Wire Frame Units	Add -TF3	\$617	Located in the rightmost cabinet, behind left and right doors
(2) 24" Depth Double Wire Frame Units	Add -TF4	\$954	Located in the rightmost cabinet, behind left and right doors
24" Depth Equipment Rack Options Available on Buffet Height Credenzas			
Fixed Equipment Rack	Add -R2	\$947	Located in left most cabinet, behind left and right doors
Sliding Equipment Rack	Add -R1	\$3,467	Located in left most cabinet, behind left and right doors

ADDITIONAL HANDLE PULL OPTIONS

Wood Frame Pull-Out Waste/Recycling Bin Unit Conference and Buffet Height Credenzas (Excludes 36" width)			
(1) 20" Depth Single Wood Frame Unit	Add -FWTF1	\$817	Located in the rightmost cabinet, applied to right door
(1) 24" Depth Double Wood Frame Unit	Add -FWTF2	\$1,225	Located in the rightmost cabinet, applied to right door
Dual Wood Frame Pull-Out Waste/Recycling Bin Unit Conference and Buffet Height Credenzas (Excludes 36"-54" width)			
(2) 20" Depth Single Wood Frame Units	Add -FWTF3	\$1,633	Located in the rightmost cabinet, applied to left and right doors
(2) 24" Depth Double Wood Frame Units	Add -FWTF4	\$2,450	Located in the rightmost cabinet, applied to left and right doors
24" Depth Single Pull-Out Drawer Refrigerator Available on Conference and Buffet Height Credenzas			
Pull-Out Drawer Refrigerator	Add -FWOM24	\$7,327	Located in left most cabinet, includes applied door panel

EDGE PROFILE



Square Edge

REQUIRED INFORMATION (ORDER CANNOT BE ENTERED WITHOUT THIS INFORMATION)

See appendix pages vi-viii for surface material options.

- Choose Door Style: Defaults to case finish, if none selected
- Choose Pull Style: Defaults to Push Latch, if none selected
- Choose Metal Finish
- Choose Veneer Finish
- Choose Paint Finish, if specified

GENERAL INFORMATION

- Tops are 3/4"-thick with 3/16"-deep hardwood edge band
- When veneer case is specified, the case exterior is standard slip-match layup regardless of veneer door style selection
- Pull-Out Waste/Recycling Bin size: 17-7/8" x 8-3/32" x 11-9/16"; (1) 35 Qt.; Double Pull-Out Waste/Recycling Units include two bins
- When lock option is specified, color will default based on leg finish:
 - Aged Bronze, Black, Galaxy, Shadow, and Storm: Black
 - Cloud: White
 - Burnish, Foil, and Satin Bronze: Satin Nickel
 - Chrome: Polished Nickel
- Credenzas include one adjustable shelf behind each door unless other components are specified
- Equipment racks hold 12RU and include a thermostatically controlled fan and plug strip



FENIX® TOP WITH HARDWOOD EDGE

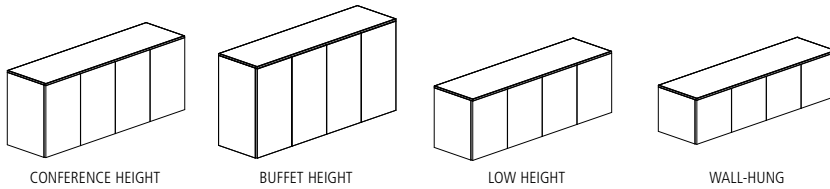

CASE MATERIAL KEY

V Veneer Case

CASE ONLY

MODEL #	W x D x H	DESCRIPTION	-V
CONFERENCE HEIGHT (29.5 INCH CASE)			
FWCC-3629-W-X	36 x 20 x 29.5	Two Doors	6,401
FWCC-5429-W-X	54 x 20 x 29.5	Three Doors	8,329
FWCC-7229-W-X	72 x 20 x 29.5	Four Doors	10,264
FWCC-9029-W-X	90 x 20 x 29.5	Five Doors	12,197
FWCD-3629-W-X	36 x 24 x 29.5	Two Doors	7,038
FWCD-5429-W-X	54 x 24 x 29.5	Three Doors	9,162
FWCD-7229-W-X	72 x 24 x 29.5	Four Doors	11,290
FWCD-9029-W-X	90 x 24 x 29.5	Five Doors	13,414
BUFFET HEIGHT (36.5 INCH CASE)			
FWBC-3636-W-X	36 x 20 x 36.5	Two Doors	7,358
FWBC-5436-W-X	54 x 20 x 36.5	Three Doors	9,576
FWBC-7236-W-X	72 x 20 x 36.5	Four Doors	11,798
FWBC-9036-W-X	90 x 20 x 36.5	Five Doors	14,023
FWBD-3636-W-X	36 x 24 x 36.5	Two Doors	8,093
FWBD-5436-W-X	54 x 24 x 36.5	Three Doors	10,534
FWBD-7236-W-X	72 x 24 x 36.5	Four Doors	12,978
FWBD-9036-W-X	90 x 24 x 36.5	Five Doors	15,424
LOW HEIGHT (24.5 INCH CASE)			
FWLC-3624-W-X	36 x 20 x 24.5	Two Doors	5,929
FWLC-5424-W-X	54 x 20 x 24.5	Three Doors	7,715
FWLC-7224-W-X	72 x 20 x 24.5	Four Doors	9,506
FWLC-9024-W-X	90 x 20 x 24.5	Five Doors	11,295
FWLD-3624-W-X	36 x 24 x 24.5	Two Doors	6,520
FWLD-5424-W-X	54 x 24 x 24.5	Three Doors	8,485
FWLD-7224-W-X	72 x 24 x 24.5	Four Doors	10,453
FWLD-9024-W-X	90 x 24 x 24.5	Five Doors	12,422
WALL-HUNG (18 INCH CASE)			
FWWC-3618-W-X	36 x 20 x 18	Two Doors	5,439
FWWC-5418-W-X	54 x 20 x 18	Three Doors	7,083
FWWC-7218-W-X	72 x 20 x 18	Four Doors	8,725
FWWC-9018-W-X	90 x 20 x 18	Five Doors	10,367

DOOR STYLE

DESCRIPTION	CODE	NOTES	PRICE
Vertical Veneer	-VD		No Charge
Horizontal Veneer	-HD		No Charge

PULL STYLE

DESCRIPTION	CODE	NOTES	TWO DOOR	THREE DOOR	FOUR DOOR	FIVE DOOR
Push Latch	No Code	Push to open (no pull). Applied to all doors.	No Charge	No Charge	No Charge	No Charge
Handle Pull - Powder Coat	-HP	Pull to open. Applied to all doors.	\$157	\$236	\$314	\$392
Handle Pull - High Polish Finish	-HP-HPF	Pull to open. Applied to all doors.	\$277	\$416	\$554	\$693
Handle Pull - Clear Anodized	-HP-CA	Pull to open. Applied to all doors.	\$157	\$236	\$314	\$392
Handle Pull - Goldmatt Anodized	-HP-GMA	Pull to open. Applied to all doors.	\$230	\$345	\$460	\$575
Handle Pull - Antique Brass Anodized	-HP-ABA	Pull to open. Applied to all doors.	\$230	\$345	\$460	\$575
Handle Pull - Light Bronze Anodized	-HP-LBA	Pull to open. Applied to all doors.	\$230	\$345	\$460	\$575



FENIX® TOP WITH HARDWOOD EDGE

PUSH LATCH OR HANDLE PULL OPTIONS	CODE	PRICE	NOTES
Locks	Add -LK	\$315	Locks included in all cabinets
Drawers Behind Doors	Add -D	\$614	Available on Buffet Height Credenza
Wire Frame Pull-Out Waste/Recycling Unit Conference, Buffet, and Low Height Credenzas (excludes 36" width)			
(1) 20" Depth Single Wire Frame Unit	Add -TF1	\$309	Located in the rightmost cabinet, behind the right door
(1) 24" Depth Double Wire Frame Unit	Add -TF2	\$477	Located in the rightmost cabinet, behind the right door
Dual Wire Frame Pull-Out Waste/Recycling Units Conference, Buffet, and Low Height Credenzas (Excludes 36"-54" width)			
(2) 20" Depth Single Wire Frame Units	Add -TF3	\$617	Located in the rightmost cabinet, behind left and right doors
(2) 24" Depth Double Wire Frame Units	Add -TF4	\$954	Located in the rightmost cabinet, behind left and right doors
24" Depth Equipment Rack Options Available on Conference and Buffet Height Credenzas			
Fixed Equipment Rack	Add -R2	\$947	Located in left most cabinet, behind left and right doors
Sliding Equipment Rack	Add -R1	\$3,467	Located in left most cabinet, behind left and right doors

ADDITIONAL HANDLE PULL OPTIONS

Wood Frame Pull-Out Waste/Recycling Bin Unit Conference, Buffet, and Low Height Credenzas (Excludes 36" width)			
(1) 20" Depth Single Wood Frame Unit	Add -FWTF1	\$817	Located in the rightmost cabinet, applied to right door
(1) 24" Depth Double Wood Frame Unit	Add -FWTF2	\$1,225	Located in the rightmost cabinet, applied to right door
Dual Wood Frame Pull-Out Waste/Recycling Bin Unit Conference, Buffet, and Low Height Credenzas (Excludes 36"-54" width)			
(2) 20" Depth Single Wood Frame Units	Add -FWTF3	\$1,633	Located in the rightmost cabinet, applied to left and right doors
(2) 24" Depth Double Wood Frame Units	Add -FWTF4	\$2,450	Located in the rightmost cabinet, applied to left and right doors
24" Depth Single Pull-Out Drawer Refrigerator Available on Conference and Low Height Credenzas			
Pull-Out Drawer Refrigerator	Add -FWOM24	\$7,327	Located in left most cabinet, includes applied door panel

EDGE PROFILE



Square Edge

REQUIRED INFORMATION (ORDER CANNOT BE ENTERED WITHOUT THIS INFORMATION)

See appendix pages vi-viii for surface material options.

- Choose Door Style: Defaults to case finish, if none selected
- Choose Pull Style: Defaults to Push Latch, if none selected
- Choose Veneer Finish
- Choose Fenix

GENERAL INFORMATION

- Tops are 3/4"-thick with 3/16"-deep hardwood edge band
- When veneer case is specified, the case exterior is standard slip-match layout regardless of veneer door style selection
- Pull-Out Waste/Recycling Bin size: 17-7/8" x 8-3/32" x 11-9/16"; (1) 35 Qt.; Double Pull-Out Waste/Recycling Units include two bins
- Locks
 - Veneer (Case Only) - When lock option is specified, color will default to Satin Nickel
- Credenzas include one adjustable shelf behind each door unless other components are specified
- Equipment racks hold 12RU and include a thermostatically controlled fan and plug strip



FENIX® TOP WITH HARDWOOD EDGE

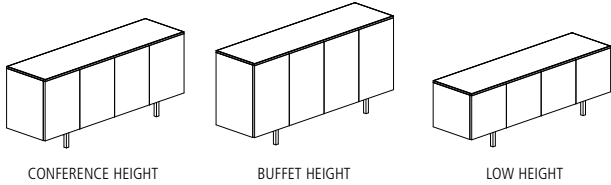

CASE MATERIAL KEY

V-IB Veneer Case with Inset Leg

INSET LEG

MODEL #	W x D x H	DESCRIPTION	-V-IB
CONFERENCE HEIGHT (24 IN. CASE WITH 6.5 IN. INSET LEG)			
FWLC-3629-W-X	36 x 20 x 30.5	Two Doors	6,451
FWLC-5429-W-X	54 x 20 x 30.5	Three Doors	8,237
FWLC-7229-W-X	72 x 20 x 30.5	Four Doors	10,026
FWLC-9029-W-X	90 x 20 x 30.5	Five Doors	11,816
FWLD-3629-W-X	36 x 24 x 30.5	Two Doors	7,038
FWLD-5429-W-X	54 x 24 x 30.5	Three Doors	9,004
FWLD-7229-W-X	72 x 24 x 30.5	Four Doors	10,974
FWLD-9029-W-X	90 x 24 x 30.5	Five Doors	12,944
BUFFET HEIGHT (29 IN. CASE WITH 6.5 IN. INSET LEG)			
FWCC-3636-W-X	36 x 20 x 35.5	Two Doors	6,921
FWCC-5436-W-X	54 x 20 x 35.5	Three Doors	8,851
FWCC-7236-W-X	72 x 20 x 35.5	Four Doors	10,786
FWCC-9036-W-X	90 x 20 x 35.5	Five Doors	12,717
FWCD-3636-W-X	36 x 24 x 35.5	Two Doors	7,561
FWCD-5436-W-X	54 x 24 x 35.5	Three Doors	9,682
FWCD-7236-W-X	72 x 24 x 35.5	Four Doors	11,806
FWCD-9036-W-X	90 x 24 x 35.5	Five Doors	13,935
LOW HEIGHT (18 IN. CASE WITH 6.5 IN. INSET LEG)			
FWWC-3624-W-X	36 x 20 x 24.5	Two Doors	5,963
FWWC-5424-W-X	54 x 20 x 24.5	Three Doors	7,603
FWWC-7224-W-X	72 x 20 x 24.5	Four Doors	9,243
FWWC-9024-W-X	90 x 20 x 24.5	Five Doors	10,890

DOOR STYLE

DESCRIPTION	CODE	NOTES	PRICE
Vertical Veneer	-VD		No Charge
Horizontal Veneer	-HD		No Charge

PULL STYLE

DESCRIPTION	CODE	NOTES	TWO DOOR	THREE DOOR	FOUR DOOR	FIVE DOOR
Push Latch	No Code	Push to open (no pull). Applied to all doors.	No Charge	No Charge	No Charge	No Charge
Handle Pull - Powder Coat	-HP	Pull to open. Applied to all doors.	\$157	\$236	\$314	\$392
Handle Pull - High Polish Finish	-HP-HPF	Pull to open. Applied to all doors.	\$277	\$416	\$554	\$693
Handle Pull - Clear Anodized	-HP-CA	Pull to open. Applied to all doors.	\$157	\$236	\$314	\$392
Handle Pull - Goldmatt Anodized	-HP-GMA	Pull to open. Applied to all doors.	\$230	\$345	\$460	\$575
Handle Pull - Antique Brass Anodized	-HP-ABA	Pull to open. Applied to all doors.	\$230	\$345	\$460	\$575
Handle Pull - Light Bronze Anodized	-HP-LBA	Pull to open. Applied to all doors.	\$230	\$345	\$460	\$575



FENIX® TOP WITH HARDWOOD EDGE

PUSH LATCH OR HANDLE PULL OPTIONS	CODE	PRICE	NOTES
Locks	Add -LK	\$315	Locks included in all cabinets
Polished Chrome Base	Add -PCIB	\$501	
Wire Frame Pull-Out Waste/Recycling Unit Conference and Buffet Height Credenzas (excludes 36" width)			
(1) 20" Depth Single Wire Frame Unit	Add -TF1	\$309	Located in the rightmost cabinet, behind the right door
(1) 24" Depth Double Wire Frame Unit	Add -TF2	\$477	Located in the rightmost cabinet, behind the right door
Dual Wire Frame Pull-Out Waste/Recycling Units Conference and Buffet Height Credenzas (Excludes 36"-54" width)			
(2) 20" Depth Single Wire Frame Units	Add -TF3	\$617	Located in the rightmost cabinet, behind left and right doors
(2) 24" Depth Double Wire Frame Units	Add -TF4	\$954	Located in the rightmost cabinet, behind left and right doors
24" Depth Equipment Rack Options Available on Buffet Height Credenzas			
Fixed Equipment Rack	Add -R2	\$947	Located in left most cabinet, behind left and right doors
Sliding Equipment Rack	Add -R1	\$3,467	Located in left most cabinet, behind left and right doors

ADDITIONAL HANDLE PULL OPTIONS

Wood Frame Pull-Out Waste/Recycling Bin Unit Conference and Buffet Height Credenzas (Excludes 36" width)			
(1) 20" Depth Single Wood Frame Unit	Add -FWTF1	\$817	Located in the rightmost cabinet, applied to right door
(1) 24" Depth Double Wood Frame Unit	Add -FWTF2	\$1,225	Located in the rightmost cabinet, applied to right door
Dual Wood Frame Pull-Out Waste/Recycling Bin Unit Conference and Buffet Height Credenzas (Excludes 36"-54" width)			
(2) 20" Depth Single Wood Frame Units	Add -FWTF3	\$1,633	Located in the rightmost cabinet, applied to left and right doors
(2) 24" Depth Double Wood Frame Units	Add -FWTF4	\$2,450	Located in the rightmost cabinet, applied to left and right doors
24" Depth Single Pull-Out Drawer Refrigerator Available on Conference and Buffet Height Credenzas			
Pull-Out Drawer Refrigerator	Add -FWOM24	\$7,327	Located in left most cabinet, includes applied door panel

EDGE PROFILE



Square Edge

REQUIRED INFORMATION (ORDER CANNOT BE ENTERED WITHOUT THIS INFORMATION)

See appendix pages vi-viii for surface material options.

- Choose Door Style: Defaults to case finish, if none selected
- Choose Pull Style: Defaults to Push Latch, if none selected
- Choose Metal Finish
- Choose Veneer Finish
- Choose Fenix

GENERAL INFORMATION

- Tops are 3/4"-thick with 3/16"-deep hardwood edge band
- When veneer case is specified, the case exterior is standard slip-match layup regardless of veneer door style selection
- Pull-Out Waste/Recycling Bin size: 17-7/8" x 8-3/32" x 11-9/16"; (1) 35 Qt.; Double Pull-Out Waste/Recycling Units include two bins
- When lock option is specified, color will default based on leg finish:
 - Aged Bronze, Black, Galaxy, Shadow, and Storm: Black
 - Cloud: White
 - Burnish, Foil, and Satin Bronze: Satin Nickel
 - Chrome: Polished Nickel
- Credenzas include one adjustable shelf behind each door unless other components are specified
- Equipment racks hold 12RU and include a thermostatically controlled fan and plug strip



FENIX® TOP WITH HARDWOOD EDGE

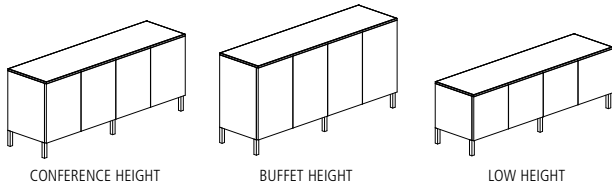

CASE MATERIAL KEY

V-OB Veneer Case with Edge-mount Post Leg

EDGE-MOUNT POST LEG

MODEL #	W x D x H	DESCRIPTION	-V-OB
CONFERENCE HEIGHT (24 IN. CASE WITH 6.5 IN. EDGE-MOUNT POST LEG)			
FWLC-3629-W-X	36 x 20 x 30.5	Two Door	6,451
FWLC-5429-W-X	54 x 20 x 30.5	Three Door	8,237
FWLC-7229-W-X	72 x 20 x 30.5	Four Door	10,026
FWLC-9029-W-X	90 x 20 x 30.5	Five Door	11,816
FWLD-3629-W-X	36 x 24 x 30.5	Two Door	7,038
FWLD-5429-W-X	54 x 24 x 30.5	Three Door	9,004
FWLD-7229-W-X	72 x 24 x 30.5	Four Door	10,974
FWLD-9029-W-X	90 x 24 x 30.5	Five Door	12,944
BUFFET HEIGHT (29 IN. CASE WITH 6.5 IN. EDGE-MOUNT POST LEG)			
FWCC-3636-W-X	36 x 20 x 35.5	Two Door	6,921
FWCC-5436-W-X	54 x 20 x 35.5	Three Door	8,851
FWCC-7236-W-X	72 x 20 x 35.5	Four Door	10,786
FWCC-9036-W-X	90 x 20 x 35.5	Five Door	12,717
FWCD-3636-W-X	36 x 24 x 35.5	Two Door	7,561
FWCD-5436-W-X	54 x 24 x 35.5	Three Door	9,682
FWCD-7236-W-X	72 x 24 x 35.5	Four Door	11,806
FWCD-9036-W-X	90 x 24 x 35.5	Five Door	13,935
LOW HEIGHT (18 IN. CASE WITH 6.5 IN. EDGE-MOUNT POST LEG)			
FWWC-3624-W-X	36 x 20 x 24.5	Two Door	5,963
FWWC-5424-W-X	54 x 20 x 24.5	Three Door	7,603
FWWC-7224-W-X	72 x 20 x 24.5	Four Door	9,243
FWWC-9024-W-X	90 x 20 x 24.5	Five Door	10,890

DOOR STYLE

DESCRIPTION	CODE	NOTES	PRICE
Vertical Veneer	-VD		No Charge
Horizontal Veneer	-HD		No Charge

PULL STYLE

DESCRIPTION	CODE	NOTES	TWO DOOR	THREE DOOR	FOUR DOOR	FIVE DOOR
Push Latch	No Code	Push to open (no pull). Applied to all doors.	No Charge	No Charge	No Charge	No Charge
Handle Pull - Powder Coat	-HP	Pull to open. Applied to all doors.	\$157	\$236	\$314	\$392
Handle Pull - High Polish Finish	-HP-HPF	Pull to open. Applied to all doors.	\$277	\$416	\$554	\$693
Handle Pull - Clear Anodized	-HP-CA	Pull to open. Applied to all doors.	\$157	\$236	\$314	\$392
Handle Pull - Goldmatt Anodized	-HP-GMA	Pull to open. Applied to all doors.	\$230	\$345	\$460	\$575
Handle Pull - Antique Brass Anodized	-HP-ABA	Pull to open. Applied to all doors.	\$230	\$345	\$460	\$575
Handle Pull - Light Bronze Anodized	-HP-LBA	Pull to open. Applied to all doors.	\$230	\$345	\$460	\$575



FENIX® TOP WITH HARDWOOD EDGE

PUSH LATCH OR HANDLE PULL OPTIONS	CODE	PRICE	NOTES
Locks	Add -LK	\$315	Locks included in all cabinets
Polished Chrome Base	Add -PCOB	\$541	
Wire Frame Pull-Out Waste/Recycling Unit Conference and Buffet Height Credenzas (excludes 36" width)			
(1) 20" Depth Single Wire Frame Unit	Add -TF1	\$309	Located in the rightmost cabinet, behind the right door
(1) 24" Depth Double Wire Frame Unit	Add -TF2	\$477	Located in the rightmost cabinet, behind the right door
Dual Wire Frame Pull-Out Waste/Recycling Units Conference and Buffet Height Credenzas (Excludes 36"-54" width)			
(2) 20" Depth Single Wire Frame Units	Add -TF3	\$617	Located in the rightmost cabinet, behind left and right doors
(2) 24" Depth Double Wire Frame Units	Add -TF4	\$954	Located in the rightmost cabinet, behind left and right doors
24" Depth Equipment Rack Options Available on Buffet Height Credenzas			
Fixed Equipment Rack	Add -R2	\$947	Located in left most cabinet, behind left and right doors
Sliding Equipment Rack	Add -R1	\$3,467	Located in left most cabinet, behind left and right doors

ADDITIONAL HANDLE PULL OPTIONS

Wood Frame Pull-Out Waste/Recycling Bin Unit Conference and Buffet Height Credenzas (Excludes 36" width)			
(1) 20" Depth Single Wood Frame Unit	Add -FWTF1	\$817	Located in the rightmost cabinet, applied to right door
(1) 24" Depth Double Wood Frame Unit	Add -FWTF2	\$1,225	Located in the rightmost cabinet, applied to right door
Dual Wood Frame Pull-Out Waste/Recycling Bin Unit Conference and Buffet Height Credenzas (Excludes 36"-54" width)			
(2) 20" Depth Single Wood Frame Units	Add -FWTF3	\$1,633	Located in the rightmost cabinet, applied to left and right doors
(2) 24" Depth Double Wood Frame Units	Add -FWTF4	\$2,450	Located in the rightmost cabinet, applied to left and right doors
24" Depth Single Pull-Out Drawer Refrigerator Available on Conference and Buffet Height Credenzas			
Pull-Out Drawer Refrigerator	Add -FWOM24	\$7,327	Located in left most cabinet, includes applied door panel

EDGE PROFILE



Square Edge

REQUIRED INFORMATION (ORDER CANNOT BE ENTERED WITHOUT THIS INFORMATION)

See appendix pages vi-viii for surface material options.

- Choose Door Style: Defaults to case finish, if none selected
- Choose Pull Style: Defaults to Push Latch, if none selected
- Choose Metal Finish
- Choose Veneer Finish
- Choose Fenix

GENERAL INFORMATION

- Tops are 3/4"-thick with 3/16"-deep hardwood edge band
- When veneer case is specified, the case exterior is standard slip-match layup regardless of veneer door style selection
- Pull-Out Waste/Recycling Bin size: 17-7/8" x 8-3/32" x 11-9/16"; (1) 35 Qt.; Double Pull-Out Waste/Recycling Units include two bins
- When lock option is specified, color will default based on leg finish:
 - Aged Bronze, Black, Galaxy, Shadow, and Storm: Black
 - Cloud: White
 - Burnish, Foil, and Satin Bronze: Satin Nickel
 - Chrome: Polished Nickel
- Credenzas include one adjustable shelf behind each door unless other components are specified
- Equipment racks hold 12RU and include a thermostatically controlled fan and plug strip



FENIX® TOP WITH HARDWOOD EDGE

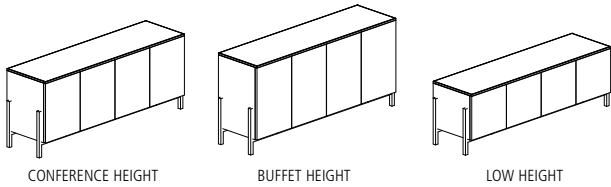

CASE MATERIAL KEY

V-CB Veneer Case with Cradle Base

CRADLE BASE

MODEL #	W x D x H	DESCRIPTION	-V-CB
CONFERENCE HEIGHT (24 IN. CASE WITH 6.5 IN. CRADLE BASE)			
FWLC-3629-W-X	36 x 20 x 30.5	Two Doors	7,143
FWLC-5429-W-X	54 x 20 x 30.5	Three Doors	8,929
FWLC-7229-W-X	72 x 20 x 30.5	Four Doors	10,723
FWLC-9029-W-X	90 x 20 x 30.5	Five Doors	12,511
FWLD-3629-W-X	36 x 24 x 30.5	Two Doors	7,733
FWLD-5429-W-X	54 x 24 x 30.5	Three Doors	9,701
FWLD-7229-W-X	72 x 24 x 30.5	Four Doors	11,667
FWLD-9029-W-X	90 x 24 x 30.5	Five Doors	13,638
BUFFET HEIGHT (29 IN. CASE WITH 6.5 IN. CRADLE BASE)			
FWCC-3636-W-X	36 x 20 x 35.5	Two Doors	7,616
FWCC-5436-W-X	54 x 20 x 35.5	Three Doors	9,544
FWCC-7236-W-X	72 x 20 x 35.5	Four Doors	11,480
FWCC-9036-W-X	90 x 20 x 35.5	Five Doors	13,411
FWCD-3636-W-X	36 x 24 x 35.5	Two Doors	8,254
FWCD-5436-W-X	54 x 24 x 35.5	Three Doors	10,377
FWCD-7236-W-X	72 x 24 x 35.5	Four Doors	12,502
FWCD-9036-W-X	90 x 24 x 35.5	Five Doors	14,633
LOW HEIGHT (18 IN. CASE WITH 6.5 IN. CRADLE BASE)			
FWWC-3624-W-X	36 x 20 x 24.5	Two Doors	6,655
FWWC-5424-W-X	54 x 20 x 24.5	Three Doors	8,297
FWWC-7224-W-X	72 x 20 x 24.5	Four Doors	9,938
FWWC-9024-W-X	90 x 20 x 24.5	Five Doors	11,583

DOOR STYLE

DESCRIPTION	CODE	NOTES	PRICE
Vertical Veneer	-VD		No Charge
Horizontal Veneer	-HD		No Charge

PULL STYLE

DESCRIPTION	CODE	NOTES	TWO DOOR	THREE DOOR	FOUR DOOR	FIVE DOOR
Push Latch	No Code	Push to open (no pull). Applied to all doors.	No Charge	No Charge	No Charge	No Charge
Handle Pull - Powder Coat	-HP	Pull to open. Applied to all doors.	\$157	\$236	\$314	\$392
Handle Pull - High Polish Finish	-HP-HPF	Pull to open. Applied to all doors.	\$277	\$416	\$554	\$693
Handle Pull - Clear Anodized	-HP-CA	Pull to open. Applied to all doors.	\$157	\$236	\$314	\$392
Handle Pull - Goldmatt Anodized	-HP-GMA	Pull to open. Applied to all doors.	\$230	\$345	\$460	\$575
Handle Pull - Antique Brass Anodized	-HP-ABA	Pull to open. Applied to all doors.	\$230	\$345	\$460	\$575
Handle Pull - Light Bronze Anodized	-HP-LBA	Pull to open. Applied to all doors.	\$230	\$345	\$460	\$575



FENIX® TOP WITH HARDWOOD EDGE

PUSH LATCH OR HANDLE PULL OPTIONS	CODE	PRICE	NOTES
Locks	Add -LK	\$315	Locks included in all cabinets
Polished Chrome Base	Add -PCCB	\$1,775	
Wire Frame Pull-Out Waste/Recycling Unit Conference and Buffet Height Credenzas (excludes 36" width)			
(1) 20" Depth Single Wire Frame Unit	Add -TF1	\$309	Located in the rightmost cabinet, behind the right door
(1) 24" Depth Double Wire Frame Unit	Add -TF2	\$477	Located in the rightmost cabinet, behind the right door
Dual Wire Frame Pull-Out Waste/Recycling Units Conference and Buffet Height Credenzas (Excludes 36"-54" width)			
(2) 20" Depth Single Wire Frame Units	Add -TF3	\$617	Located in the rightmost cabinet, behind left and right doors
(2) 24" Depth Double Wire Frame Units	Add -TF4	\$954	Located in the rightmost cabinet, behind left and right doors
24" Depth Equipment Rack Options Available on Buffet Height Credenzas			
Fixed Equipment Rack	Add -R2	\$947	Located in left most cabinet, behind left and right doors
Sliding Equipment Rack	Add -R1	\$3,467	Located in left most cabinet, behind left and right doors

ADDITIONAL HANDLE PULL OPTIONS

Wood Frame Pull-Out Waste/Recycling Bin Unit Conference and Buffet Height Credenzas (Excludes 36" width)			
(1) 20" Depth Single Wood Frame Unit	Add -FWTF1	\$817	Located in the rightmost cabinet, applied to right door
(1) 24" Depth Double Wood Frame Unit	Add -FWTF2	\$1,225	Located in the rightmost cabinet, applied to right door
Dual Wood Frame Pull-Out Waste/Recycling Bin Unit Conference and Buffet Height Credenzas (Excludes 36"-54" width)			
(2) 20" Depth Single Wood Frame Units	Add -FWTF3	\$1,633	Located in the rightmost cabinet, applied to left and right doors
(2) 24" Depth Double Wood Frame Units	Add -FWTF4	\$2,450	Located in the rightmost cabinet, applied to left and right doors
24" Depth Single Pull-Out Drawer Refrigerator Available on Conference and Buffet Height Credenzas			
Pull-Out Drawer Refrigerator	Add -FWOM24	\$7,327	Located in left most cabinet, includes applied door panel

EDGE PROFILE



Square Edge

REQUIRED INFORMATION (ORDER CANNOT BE ENTERED WITHOUT THIS INFORMATION)

See appendix pages vi-viii for surface material options.

- Choose Door Style: Defaults to case finish, if none selected
- Choose Pull Style: Defaults to Push Latch, if none selected
- Choose Metal Finish
- Choose Veneer Finish
- Choose Fenix

GENERAL INFORMATION

- Tops are 3/4"-thick with 3/16"-deep hardwood edge band
- When veneer case is specified, the case exterior is standard slip-match layup regardless of veneer door style selection
- Pull-Out Waste/Recycling Bin size: 17-7/8" x 8-3/32" x 11-9/16"; (1) 35 Qt.; Double Pull-Out Waste/Recycling Units include two bins
- When lock option is specified, color will default based on leg finish:
 - Aged Bronze, Black, Galaxy, Shadow, and Storm: Black
 - Cloud: White
 - Burnish, Foil, and Satin Bronze: Satin Nickel
 - Chrome: Polished Nickel
- Credenzas include one adjustable shelf behind each door unless other components are specified
- Equipment racks hold 12RU and include a thermostatically controlled fan and plug strip



FENIX® TOP WITH HARDWOOD EDGE

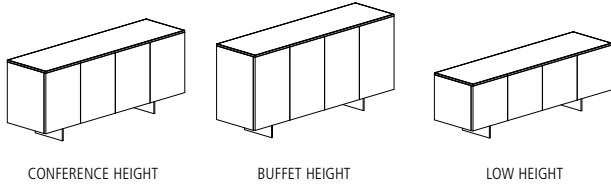

CASE MATERIAL KEY

V-BB Veneer Case with Blade Base

BLADE BASE

MODEL #	W x D x H	DESCRIPTION	-V-BB
CONFERENCE HEIGHT (24 IN. CASE WITH 6 IN. BLADE BASE)			
FWLC-3629-W-X	36 x 20 x 30	Two Doors	6,796
FWLC-5429-W-X	54 x 20 x 30	Three Doors	8,581
FWLC-7229-W-X	72 x 20 x 30	Four Doors	10,373
FWLC-9029-W-X	90 x 20 x 30	Five Doors	12,162
FWLD-3629-W-X	36 x 24 x 30	Two Doors	7,387
FWLD-5429-W-X	54 x 24 x 30	Three Doors	9,352
FWLD-7229-W-X	72 x 24 x 30	Four Doors	11,321
FWLD-9029-W-X	90 x 24 x 30	Five Doors	13,289
BUFFET HEIGHT (29 IN. CASE WITH 6 IN. BLADE BASE)			
FWCC-3636-W-X	36 x 20 x 35	Two Doors	7,270
FWCC-5436-W-X	54 x 20 x 35	Three Doors	9,198
FWCC-7236-W-X	72 x 20 x 35	Four Doors	11,135
FWCC-9036-W-X	90 x 20 x 35	Five Doors	13,065
FWCD-3636-W-X	36 x 24 x 35	Two Doors	7,909
FWCD-5436-W-X	54 x 24 x 35	Three Doors	10,028
FWCD-7236-W-X	72 x 24 x 35	Four Doors	12,157
FWCD-9036-W-X	90 x 24 x 35	Five Doors	14,285
LOW HEIGHT (18 IN. CASE WITH 6 IN. BLADE BASE)			
FWWC-3624-W-X	36 x 20 x 24	Two Doors	6,310
FWWC-5424-W-X	54 x 20 x 24	Three Doors	7,953
FWWC-7224-W-X	72 x 20 x 24	Four Doors	9,592
FWWC-9024-W-X	90 x 20 x 24	Five Doors	11,235

DOOR STYLE

DESCRIPTION	CODE	NOTES	PRICE
Vertical Veneer	-VD		No Charge
Horizontal Veneer	-HD		No Charge

PULL STYLE

DESCRIPTION	CODE	NOTES	TWO DOOR	THREE DOOR	FOUR DOOR	FIVE DOOR
Push Latch	No Code	Push to open (no pull). Applied to all doors.	No Charge	No Charge	No Charge	No Charge
Handle Pull - Powder Coat	-HP	Pull to open. Applied to all doors.	\$157	\$236	\$314	\$392
Handle Pull - High Polish Finish	-HP-HPF	Pull to open. Applied to all doors.	\$277	\$416	\$554	\$693
Handle Pull - Clear Anodized	-HP-CA	Pull to open. Applied to all doors.	\$157	\$236	\$314	\$392
Handle Pull - Goldmatt Anodized	-HP-GMA	Pull to open. Applied to all doors.	\$230	\$345	\$460	\$575
Handle Pull - Antique Brass Anodized	-HP-ABA	Pull to open. Applied to all doors.	\$230	\$345	\$460	\$575
Handle Pull - Light Bronze Anodized	-HP-LBA	Pull to open. Applied to all doors.	\$230	\$345	\$460	\$575



FENIX® TOP WITH HARDWOOD EDGE

PUSH LATCH OR HANDLE PULL OPTIONS	CODE	PRICE	NOTES
Locks	Add -LK	\$315	Locks included in all cabinets
Polished Chrome Base	Add -PCBB	\$501	
Wire Frame Pull-Out Waste/Recycling Unit Conference and Buffet Height Credenzas (excludes 36" width)			
(1) 20" Depth Single Wire Frame Unit	Add -TF1	\$309	Located in the rightmost cabinet, behind the right door
(1) 24" Depth Double Wire Frame Unit	Add -TF2	\$477	Located in the rightmost cabinet, behind the right door
Dual Wire Frame Pull-Out Waste/Recycling Units Conference and Buffet Height Credenzas (Excludes 36"-54" width)			
(2) 20" Depth Single Wire Frame Units	Add -TF3	\$617	Located in the rightmost cabinet, behind left and right doors
(2) 24" Depth Double Wire Frame Units	Add -TF4	\$954	Located in the rightmost cabinet, behind left and right doors
24" Depth Equipment Rack Options Available on Buffet Height Credenzas			
Fixed Equipment Rack	Add -R2	\$947	Located in left most cabinet, behind left and right doors
Sliding Equipment Rack	Add -R1	\$3,467	Located in left most cabinet, behind left and right doors

ADDITIONAL HANDLE PULL OPTIONS

Wood Frame Pull-Out Waste/Recycling Bin Unit Conference and Buffet Height Credenzas (Excludes 36" width)			
(1) 20" Depth Single Wood Frame Unit	Add -FWTF1	\$817	Located in the rightmost cabinet, applied to right door
(1) 24" Depth Double Wood Frame Unit	Add -FWTF2	\$1,225	Located in the rightmost cabinet, applied to right door
Dual Wood Frame Pull-Out Waste/Recycling Bin Unit Conference and Buffet Height Credenzas (Excludes 36"-54" width)			
(2) 20" Depth Single Wood Frame Units	Add -FWTF3	\$1,633	Located in the rightmost cabinet, applied to left and right doors
(2) 24" Depth Double Wood Frame Units	Add -FWTF4	\$2,450	Located in the rightmost cabinet, applied to left and right doors
24" Depth Single Pull-Out Drawer Refrigerator Available on Conference and Buffet Height Credenzas			
Pull-Out Drawer Refrigerator	Add -FWOM24	\$7,327	Located in left most cabinet, includes applied door panel

EDGE PROFILE



Square Edge

REQUIRED INFORMATION (ORDER CANNOT BE ENTERED WITHOUT THIS INFORMATION)

See appendix pages vi-viii for surface material options.

- Choose Door Style: Defaults to case finish, if none selected
- Choose Pull Style: Defaults to Push Latch, if none selected
- Choose Metal Finish
- Choose Veneer Finish
- Choose Fenix

GENERAL INFORMATION

- Tops are 3/4"-thick with 3/16"-deep hardwood edge band
- When veneer case is specified, the case exterior is standard slip-match layup regardless of veneer door style selection
- Pull-Out Waste/Recycling Bin size: 17-7/8" x 8-3/32" x 11-9/16"; (1) 35 Qt.; Double Pull-Out Waste/Recycling Units include two bins
- When lock option is specified, color will default based on leg finish:
 - Aged Bronze, Black, Galaxy, Shadow, and Storm: Black
 - Cloud: White
 - Burnish, Foil, and Satin Bronze: Satin Nickel
 - Chrome: Polished Nickel
- Credenzas include one adjustable shelf behind each door unless other components are specified
- Equipment racks hold 12RU and include a thermostatically controlled fan and plug strip



FENIX® TOP WITH SQUARE EDGE

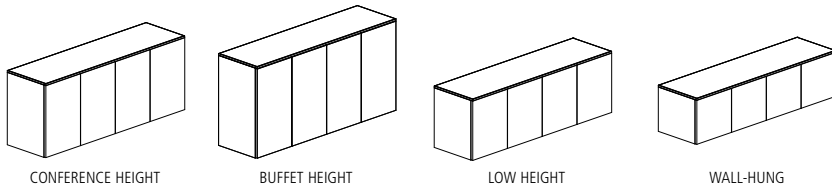

CASE MATERIAL KEY

PA Painted Case
V Veneer Case

CASE ONLY

MODEL #	W x D x H	DESCRIPTION	-PA	-V
CONFERENCE HEIGHT (29.5 INCH CASE)				
FWCC-3629-XE	36 x 20 x 29.5	Two Doors	6,094	6,094
FWCC-5429-XE	54 x 20 x 29.5	Three Doors	7,933	7,933
FWCC-7229-XE	72 x 20 x 29.5	Four Doors	9,775	9,775
FWCC-9029-XE	90 x 20 x 29.5	Five Doors	11,616	11,616
FWCD-3629-XE	36 x 24 x 29.5	Two Doors	6,705	6,705
FWCD-5429-XE	54 x 24 x 29.5	Three Doors	8,727	8,727
FWCD-7229-XE	72 x 24 x 29.5	Four Doors	10,752	10,752
FWCD-9029-XE	90 x 24 x 29.5	Five Doors	12,777	12,777
BUFFET HEIGHT (36.5 INCH CASE)				
FWBC-3636-XE	36 x 20 x 36.5	Two Doors	7,007	7,007
FWBC-5436-XE	54 x 20 x 36.5	Three Doors	9,121	9,121
FWBC-7236-XE	72 x 20 x 36.5	Four Doors	11,239	11,239
FWBC-9036-XE	90 x 20 x 36.5	Five Doors	13,355	13,355
FWBD-3636-XE	36 x 24 x 36.5	Two Doors	7,712	7,712
FWBD-5436-XE	54 x 24 x 36.5	Three Doors	10,034	10,034
FWBD-7236-XE	72 x 24 x 36.5	Four Doors	12,362	12,362
FWBD-9036-XE	90 x 24 x 36.5	Five Doors	14,688	14,688
LOW HEIGHT (24.5 INCH CASE)				
FWLC-3624-XE	36 x 20 x 24.5	Two Doors	5,643	5,643
FWLC-5424-XE	54 x 20 x 24.5	Three Doors	7,345	7,345
FWLC-7224-XE	72 x 20 x 24.5	Four Doors	9,049	9,049
FWLC-9024-XE	90 x 20 x 24.5	Five Doors	10,753	10,753
FWLD-3624-XE	36 x 24 x 24.5	Two Doors	6,208	6,208
FWLD-5424-XE	54 x 24 x 24.5	Three Doors	8,082	8,082
FWLD-7224-XE	72 x 24 x 24.5	Four Doors	9,957	9,957
FWLD-9024-XE	90 x 24 x 24.5	Five Doors	11,830	11,830
WALL-HUNG (18 INCH CASE)				
FWWC-3618-XE	36 x 20 x 18	Two Doors	5,185	5,185
FWWC-5418-XE	54 x 20 x 18	Three Doors	6,749	6,749
FWWC-7218-XE	72 x 20 x 18	Four Doors	8,308	8,308
FWWC-9018-XE	90 x 20 x 18	Five Doors	9,875	9,875

DOOR STYLE

DESCRIPTION	CODE	NOTES	PRICE
Vertical Veneer	-VD		No Charge
Horizontal Veneer	-HD		No Charge

PULL STYLE

DESCRIPTION	CODE	NOTES	TWO DOOR	THREE DOOR	FOUR DOOR	FIVE DOOR
Push Latch	No Code	Push to open (no pull). Applied to all doors.	No Charge	No Charge	No Charge	No Charge
Handle Pull - Powder Coat	-HP	Pull to open. Applied to all doors.	\$157	\$236	\$314	\$392
Handle Pull - High Polish Finish	-HP-HPF	Pull to open. Applied to all doors.	\$277	\$416	\$554	\$693
Handle Pull - Clear Anodized	-HP-CA	Pull to open. Applied to all doors.	\$157	\$236	\$314	\$392
Handle Pull - Goldmatt Anodized	-HP-GMA	Pull to open. Applied to all doors.	\$230	\$345	\$460	\$575
Handle Pull - Antique Brass Anodized	-HP-ABA	Pull to open. Applied to all doors.	\$230	\$345	\$460	\$575
Handle Pull - Light Bronze Anodized	-HP-LBA	Pull to open. Applied to all doors.	\$230	\$345	\$460	\$575



FENIX® TOP WITH SQUARE EDGE

PUSH LATCH OR HANDLE PULL OPTIONS	CODE	PRICE	NOTES
Locks	Add -LK	\$315	Locks included in all cabinets
Drawers Behind Doors	Add -D	\$614	Available on Buffet Height Credenza
Wire Frame Pull-Out Waste/Recycling Unit Conference, Buffet, and Low Height Credenzas (excludes 36" width)			
(1) 20" Depth Single Wire Frame Unit	Add -TF1	\$309	Located in the rightmost cabinet, behind the right door
(1) 24" Depth Double Wire Frame Unit	Add -TF2	\$477	Located in the rightmost cabinet, behind the right door
Dual Wire Frame Pull-Out Waste/Recycling Units Conference, Buffet, and Low Height Credenzas (Excludes 36"-54" width)			
(2) 20" Depth Single Wire Frame Units	Add -TF3	\$617	Located in the rightmost cabinet, behind left and right doors
(2) 24" Depth Double Wire Frame Units	Add -TF4	\$954	Located in the rightmost cabinet, behind left and right doors
24" Depth Equipment Rack Options Available on Conference and Buffet Height Credenzas			
Fixed Equipment Rack	Add -R2	\$947	Located in left most cabinet, behind left and right doors
Sliding Equipment Rack	Add -R1	\$3,467	Located in left most cabinet, behind left and right doors

ADDITIONAL HANDLE PULL OPTIONS

Wood Frame Pull-Out Waste/Recycling Bin Unit Conference, Buffet, and Low Height Credenzas (Excludes 36" width)			
(1) 20" Depth Single Wood Frame Unit	Add -FWTF1	\$817	Located in the rightmost cabinet, applied to right door
(1) 24" Depth Double Wood Frame Unit	Add -FWTF2	\$1,225	Located in the rightmost cabinet, applied to right door
Dual Wood Frame Pull-Out Waste/Recycling Bin Unit Conference, Buffet, and Low Height Credenzas (Excludes 36"-54" width)			
(2) 20" Depth Single Wood Frame Units	Add -FWTF3	\$1,633	Located in the rightmost cabinet, applied to left and right doors
(2) 24" Depth Double Wood Frame Units	Add -FWTF4	\$2,450	Located in the rightmost cabinet, applied to left and right doors
24" Depth Single Pull-Out Drawer Refrigerator Available on Conference and Low Height Credenzas			
Pull-Out Drawer Refrigerator	Add -FWOM24	\$7,327	Located in left most cabinet, includes applied door panel

EDGE PROFILE



Square Edge

REQUIRED INFORMATION (ORDER CANNOT BE ENTERED WITHOUT THIS INFORMATION)

See appendix pages vi-viii for surface material options.

- Choose Door Style: Defaults to case finish, if none selected
- Choose Pull Style: Defaults to Push Latch, if none selected
- Choose Paint Finish, if specified
- Choose Veneer Finish
- Choose Fenix: Defaults to coordinating edge band

GENERAL INFORMATION

- Tops are 3/4"-thick with a 2 mm edge
- When veneer case is specified, the case exterior is standard slip-match layup regardless of veneer door style selection
- Pull-Out Waste/Recycling Bin Size: 17-7/8" x 8-3/32" x 11-9/16"; (1) 35 Qt.; Double Pull-Out Waste/Recycling Units include two bins
- Locks
 - Veneer (Case Only) - When lock option is specified, color will default to Satin Nickel
- Credenzas include one adjustable shelf behind each door unless other components are specified
- Equipment racks hold 12RU and include a thermostatically controlled fan and plug strip



FENIX® TOP WITH SQUARE EDGE

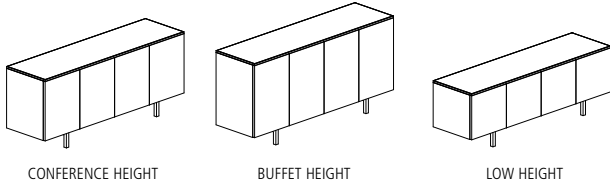

CASE MATERIAL KEY

PA-IB Painted Case with Inset Leg
 V-IB Veneer Case with Inset Leg

INSET LEG

MODEL #	W x D x H	DESCRIPTION	-PA-IB	-V-IB
CONFERENCE HEIGHT (24 IN. CASE WITH 6.5 IN. INSET LEG)				
FWLC-3629-XE	36 x 20 x 30.5	Two Doors	6,169	6,169
FWLC-5429-XE	54 x 20 x 30.5	Three Doors	7,869	7,869
FWLC-7229-XE	72 x 20 x 30.5	Four Doors	9,573	9,573
FWLC-9029-XE	90 x 20 x 30.5	Five Doors	11,275	11,275
FWLD-3629-XE	36 x 24 x 30.5	Two Doors	6,730	6,730
FWLD-5429-XE	54 x 24 x 30.5	Three Doors	8,603	8,603
FWLD-7229-XE	72 x 24 x 30.5	Four Doors	10,479	10,479
FWLD-9029-XE	90 x 24 x 30.5	Five Doors	12,349	12,349
BUFFET HEIGHT (29 IN. CASE WITH 6.5 IN. INSET LEG)				
FWCC-3636-XE	36 x 20 x 35.5	Two Doors	6,619	6,619
FWCC-5436-XE	54 x 20 x 35.5	Three Doors	8,454	8,454
FWCC-7236-XE	72 x 20 x 35.5	Four Doors	10,294	10,294
FWCC-9036-XE	90 x 20 x 35.5	Five Doors	12,135	12,135
FWCD-3636-XE	36 x 24 x 35.5	Two Doors	7,228	7,228
FWCD-5436-XE	54 x 24 x 35.5	Three Doors	9,249	9,249
FWCD-7236-XE	72 x 24 x 35.5	Four Doors	11,273	11,273
FWCD-9036-XE	90 x 24 x 35.5	Five Doors	13,297	13,297
LOW HEIGHT (18 IN. CASE WITH 6.5 IN. INSET LEG)				
FWWC-3624-XE	36 x 20 x 24.5	Two Doors	5,702	5,702
FWWC-5424-XE	54 x 20 x 24.5	Three Doors	7,270	7,270
FWWC-7224-XE	72 x 20 x 24.5	Four Doors	8,830	8,830
FWWC-9024-XE	90 x 20 x 24.5	Five Doors	10,395	10,395

DOOR STYLE

DESCRIPTION	CODE	NOTES	PRICE
Vertical Veneer	-VD		No Charge
Horizontal Veneer	-HD		No Charge

PULL STYLE

DESCRIPTION	CODE	NOTES	TWO DOOR	THREE DOOR	FOUR DOOR	FIVE DOOR
Push Latch	No Code	Push to open (no pull). Applied to all doors.	No Charge	No Charge	No Charge	No Charge
Handle Pull - Powder Coat	-HP	Pull to open. Applied to all doors.	\$157	\$236	\$314	\$392
Handle Pull - High Polish Finish	-HP-HPF	Pull to open. Applied to all doors.	\$277	\$416	\$554	\$693
Handle Pull - Clear Anodized	-HP-CA	Pull to open. Applied to all doors.	\$157	\$236	\$314	\$392
Handle Pull - Goldmatt Anodized	-HP-GMA	Pull to open. Applied to all doors.	\$230	\$345	\$460	\$575
Handle Pull - Antique Brass Anodized	-HP-ABA	Pull to open. Applied to all doors.	\$230	\$345	\$460	\$575
Handle Pull - Light Bronze Anodized	-HP-LBA	Pull to open. Applied to all doors.	\$230	\$345	\$460	\$575



FENIX® TOP WITH SQUARE EDGE

PUSH LATCH OR HANDLE PULL OPTIONS	CODE	PRICE	NOTES
Locks	Add -LK	\$315	Locks included in all cabinets
Polished Chrome Base	Add -PCIB	\$501	
Wire Frame Pull-Out Waste/Recycling Unit Conference and Buffet Height Credenzas (excludes 36" width)			
(1) 20" Depth Single Wire Frame Unit	Add -TF1	\$309	Located in the rightmost cabinet, behind the right door
(1) 24" Depth Double Wire Frame Unit	Add -TF2	\$477	Located in the rightmost cabinet, behind the right door
Dual Wire Frame Pull-Out Waste/Recycling Units Conference and Buffet Height Credenzas (Excludes 36"-54" width)			
(2) 20" Depth Single Wire Frame Units	Add -TF3	\$617	Located in the rightmost cabinet, behind left and right doors
(2) 24" Depth Double Wire Frame Units	Add -TF4	\$954	Located in the rightmost cabinet, behind left and right doors
24" Depth Equipment Rack Options Available on Buffet Height Credenzas			
Fixed Equipment Rack	Add -R2	\$947	Located in left most cabinet, behind left and right doors
Sliding Equipment Rack	Add -R1	\$3,467	Located in left most cabinet, behind left and right doors

ADDITIONAL HANDLE PULL OPTIONS

Wood Frame Pull-Out Waste/Recycling Bin Unit Conference and Buffet Height Credenzas (Excludes 36" width)			
(1) 20" Depth Single Wood Frame Unit	Add -FWTF1	\$817	Located in the rightmost cabinet, applied to right door
(1) 24" Depth Double Wood Frame Unit	Add -FWTF2	\$1,225	Located in the rightmost cabinet, applied to right door
Dual Wood Frame Pull-Out Waste/Recycling Bin Unit Conference and Buffet Height Credenzas (Excludes 36"-54" width)			
(2) 20" Depth Single Wood Frame Units	Add -FWTF3	\$1,633	Located in the rightmost cabinet, applied to left and right doors
(2) 24" Depth Double Wood Frame Units	Add -FWTF4	\$2,450	Located in the rightmost cabinet, applied to left and right doors
24" Depth Single Pull-Out Drawer Refrigerator Available on Conference and Buffet Height Credenzas			
Pull-Out Drawer Refrigerator	Add -FWOM24	\$7,327	Located in left most cabinet, includes applied door panel

EDGE PROFILE



Square Edge

REQUIRED INFORMATION (ORDER CANNOT BE ENTERED WITHOUT THIS INFORMATION)

See appendix pages vi-viii for surface material options.

- Choose Door Style: Defaults to case finish, if none selected
- Choose Pull Style: Defaults to Push Latch, if none selected
- Choose Metal Finish
- Choose Paint Finish, if specified
- Choose Veneer Finish
- Choose Fenix: Defaults to coordinating edge band

GENERAL INFORMATION

- Tops are 3/4"-thick with a 2 mm edge
- When veneer case is specified, the case exterior is standard slip-match layout regardless of veneer door style selection
- Pull-Out Waste/Recycling Bin size: 17-7/8" x 8-3/32" x 11-9/16"; (1) 35 Qt.; Double Pull-Out Waste/Recycling Units include two bins
- When lock option is specified, color will default based on leg finish:
 - Aged Bronze, Black, Galaxy, Shadow, and Storm: Black
 - Cloud: White
 - Burnish, Foil, and Satin Bronze: Satin Nickel
 - Chrome: Polished Nickel
- Credenzas include one adjustable shelf behind each door unless other components are specified
- Equipment racks hold 12RU and include a thermostatically controlled fan and plug strip



FENIX® TOP WITH SQUARE EDGE

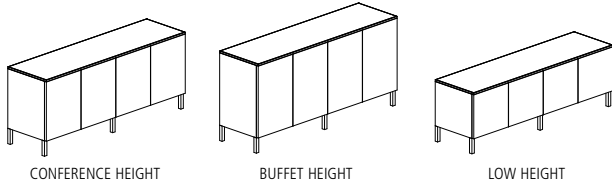

CASE MATERIAL KEY

PA-OB Painted Case with Edge-mount Post Leg
 V-OB Veneer Case with Edge-mount Post Leg

EDGE-MOUNT POST LEG

MODEL #	W x D x H	DESCRIPTION	-PA-OB	-V-OB
CONFERENCE HEIGHT (24 IN. CASE WITH 6.5 IN. EDGE-MOUNT POST LEG)				
FWLC-3629-XE	36 x 20 x 30.5	Two Door	6,169	6,169
FWLC-5429-XE	54 x 20 x 30.5	Three Door	7,869	7,869
FWLC-7229-XE	72 x 20 x 30.5	Four Door	9,573	9,573
FWLC-9029-XE	90 x 20 x 30.5	Five Door	11,275	11,275
FWLD-3629-XE	36 x 24 x 30.5	Two Door	6,730	6,730
FWLD-5429-XE	54 x 24 x 30.5	Three Door	8,603	8,603
FWLD-7229-XE	72 x 24 x 30.5	Four Door	10,479	10,479
FWLD-9029-XE	90 x 24 x 30.5	Five Door	12,349	12,349
BUFFET HEIGHT (29 IN. CASE WITH 6.5 IN. EDGE-MOUNT POST LEG)				
FWCC-3636-XE	36 x 20 x 35.5	Two Door	6,619	6,619
FWCC-5436-XE	54 x 20 x 35.5	Three Door	8,454	8,454
FWCC-7236-XE	72 x 20 x 35.5	Four Door	10,294	10,294
FWCC-9036-XE	90 x 20 x 35.5	Five Door	12,135	12,135
FWCD-3636-XE	36 x 24 x 35.5	Two Door	7,228	7,228
FWCD-5436-XE	54 x 24 x 35.5	Three Door	9,249	9,249
FWCD-7236-XE	72 x 24 x 35.5	Four Door	11,273	11,273
FWCD-9036-XE	90 x 24 x 35.5	Five Door	13,297	13,297
LOW HEIGHT (18 IN. CASE WITH 6.5 IN. EDGE-MOUNT POST LEG)				
FWWC-3624-XE	36 x 20 x 24.5	Two Door	5,702	5,702
FWWC-5424-XE	54 x 20 x 24.5	Three Door	7,270	7,270
FWWC-7224-XE	72 x 20 x 24.5	Four Door	8,830	8,830
FWWC-9024-XE	90 x 20 x 24.5	Five Door	10,395	10,395

DOOR STYLE

DESCRIPTION	CODE	NOTES	PRICE
Vertical Veneer	-VD		No Charge
Horizontal Veneer	-HD		No Charge

PULL STYLE

DESCRIPTION	CODE	NOTES	TWO DOOR	THREE DOOR	FOUR DOOR	FIVE DOOR
Push Latch	No Code	Push to open (no pull). Applied to all doors.	No Charge	No Charge	No Charge	No Charge
Handle Pull - Powder Coat	-HP	Pull to open. Applied to all doors.	\$157	\$236	\$314	\$392
Handle Pull - High Polish Finish	-HP-HPF	Pull to open. Applied to all doors.	\$277	\$416	\$554	\$693
Handle Pull - Clear Anodized	-HP-CA	Pull to open. Applied to all doors.	\$157	\$236	\$314	\$392
Handle Pull - Goldmatt Anodized	-HP-GMA	Pull to open. Applied to all doors.	\$230	\$345	\$460	\$575
Handle Pull - Antique Brass Anodized	-HP-ABA	Pull to open. Applied to all doors.	\$230	\$345	\$460	\$575
Handle Pull - Light Bronze Anodized	-HP-LBA	Pull to open. Applied to all doors.	\$230	\$345	\$460	\$575



FENIX® TOP WITH SQUARE EDGE

PUSH LATCH OR HANDLE PULL OPTIONS	CODE	PRICE	NOTES
Locks	Add -LK	\$315	Locks included in all cabinets
Polished Chrome Base	Add -PCOB	\$541	
Wire Frame Pull-Out Waste/Recycling Unit Conference and Buffet Height Credenzas (excludes 36" width)			
(1) 20" Depth Single Wire Frame Unit	Add -TF1	\$309	Located in the rightmost cabinet, behind the right door
(1) 24" Depth Double Wire Frame Unit	Add -TF2	\$477	Located in the rightmost cabinet, behind the right door
Dual Wire Frame Pull-Out Waste/Recycling Units Conference and Buffet Height Credenzas (Excludes 36"-54" width)			
(2) 20" Depth Single Wire Frame Units	Add -TF3	\$617	Located in the rightmost cabinet, behind left and right doors
(2) 24" Depth Double Wire Frame Units	Add -TF4	\$954	Located in the rightmost cabinet, behind left and right doors
24" Depth Equipment Rack Options Available on Buffet Height Credenzas			
Fixed Equipment Rack	Add -R2	\$947	Located in left most cabinet, behind left and right doors
Sliding Equipment Rack	Add -R1	\$3,467	Located in left most cabinet, behind left and right doors

ADDITIONAL HANDLE PULL OPTIONS

Wood Frame Pull-Out Waste/Recycling Bin Unit Conference and Buffet Height Credenzas (Excludes 36" width)			
(1) 20" Depth Single Wood Frame Unit	Add -FWTF1	\$817	Located in the rightmost cabinet, applied to right door
(1) 24" Depth Double Wood Frame Unit	Add -FWTF2	\$1,225	Located in the rightmost cabinet, applied to right door
Dual Wood Frame Pull-Out Waste/Recycling Bin Unit Conference and Buffet Height Credenzas (Excludes 36"-54" width)			
(2) 20" Depth Single Wood Frame Units	Add -FWTF3	\$1,633	Located in the rightmost cabinet, applied to left and right doors
(2) 24" Depth Double Wood Frame Units	Add -FWTF4	\$2,450	Located in the rightmost cabinet, applied to left and right doors
24" Depth Single Pull-Out Drawer Refrigerator Available on Conference and Buffet Height Credenzas			
Pull-Out Drawer Refrigerator	Add -FWOM24	\$7,327	Located in left most cabinet, includes applied door panel

EDGE PROFILE



Square Edge

REQUIRED INFORMATION (ORDER CANNOT BE ENTERED WITHOUT THIS INFORMATION)

See appendix pages vi-viii for surface material options.

- Choose Door Style: Defaults to case finish, if none selected
- Choose Pull Style: Defaults to Push Latch, if none selected
- Choose Metal Finish
- Choose Paint Finish, if specified
- Choose Veneer Finish
- Choose Fenix: Defaults to coordinating edge band

GENERAL INFORMATION

- Tops are 3/4" -thick with a 2 mm edge
- When veneer case is specified, the case exterior is standard slip-match layout regardless of veneer door style selection
- Pull-Out Waste/Recycling Bin size: 17-7/8" x 8-3/32" x 11-9/16"; (1) 35 Qt.; Double Pull-Out Waste/Recycling Units include two bins
- When lock option is specified, color will default based on leg finish:
 - Aged Bronze, Black, Galaxy, Shadow, and Storm: Black
 - Cloud: White
 - Burnish, Foil, and Satin Bronze: Satin Nickel
 - Chrome: Polished Nickel
- Credenzas include one adjustable shelf behind each door unless other components are specified
- Equipment racks hold 12RU and include a thermostatically controlled fan and plug strip



FENIX® TOP WITH SQUARE EDGE

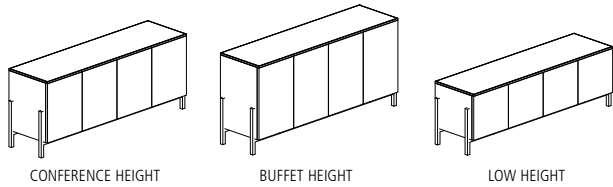

CASE MATERIAL KEY

PA-CB Painted Case with Cradle Base
 V-CB Veneer Case with Cradle Base

CRADLE BASE

MODEL #	W x D x H	DESCRIPTION	-PA-CB	-V-CB
CONFERENCE HEIGHT (24 IN. CASE WITH 6.5 IN. CRADLE BASE)				
FWLC-3629-XE	36 x 20 x 30.5	Two Doors	6,861	6,861
FWLC-5429-XE	54 x 20 x 30.5	Three Doors	8,562	8,562
FWLC-7229-XE	72 x 20 x 30.5	Four Doors	10,267	10,267
FWLC-9029-XE	90 x 20 x 30.5	Five Doors	11,971	11,971
FWLD-3629-XE	36 x 24 x 30.5	Two Doors	7,424	7,424
FWLD-5429-XE	54 x 24 x 30.5	Three Doors	9,297	9,297
FWLD-7229-XE	72 x 24 x 30.5	Four Doors	11,174	11,174
FWLD-9029-XE	90 x 24 x 30.5	Five Doors	13,046	13,046
BUFFET HEIGHT (29 IN. CASE WITH 6.5 IN. CRADLE BASE)				
FWCC-3636-XE	36 x 20 x 35.5	Two Doors	7,312	7,312
FWCC-5436-XE	54 x 20 x 35.5	Three Doors	9,148	9,148
FWCC-7236-XE	72 x 20 x 35.5	Four Doors	10,991	10,991
FWCC-9036-XE	90 x 20 x 35.5	Five Doors	12,828	12,828
FWCD-3636-XE	36 x 24 x 35.5	Two Doors	7,921	7,921
FWCD-5436-XE	54 x 24 x 35.5	Three Doors	9,941	9,941
FWCD-7236-XE	72 x 24 x 35.5	Four Doors	11,968	11,968
FWCD-9036-XE	90 x 24 x 35.5	Five Doors	13,991	13,991
LOW HEIGHT (18 IN. CASE WITH 6.5 IN. CRADLE BASE)				
FWWC-3624-XE	36 x 20 x 24.5	Two Doors	6,397	6,397
FWWC-5424-XE	54 x 20 x 24.5	Three Doors	7,962	7,962
FWWC-7224-XE	72 x 20 x 24.5	Four Doors	9,524	9,524
FWWC-9024-XE	90 x 20 x 24.5	Five Doors	11,088	11,088

DOOR STYLE

DESCRIPTION	CODE	NOTES	PRICE
Vertical Veneer	-VD		No Charge
Horizontal Veneer	-HD		No Charge

PULL STYLE

DESCRIPTION	CODE	NOTES	TWO DOOR	THREE DOOR	FOUR DOOR	FIVE DOOR
Push Latch	No Code	Push to open (no pull). Applied to all doors.	No Charge	No Charge	No Charge	No Charge
Handle Pull - Powder Coat	-HP	Pull to open. Applied to all doors.	\$157	\$236	\$314	\$392
Handle Pull - High Polish Finish	-HP-HPF	Pull to open. Applied to all doors.	\$277	\$416	\$554	\$693
Handle Pull - Clear Anodized	-HP-CA	Pull to open. Applied to all doors.	\$157	\$236	\$314	\$392
Handle Pull - Goldmatt Anodized	-HP-GMA	Pull to open. Applied to all doors.	\$230	\$345	\$460	\$575
Handle Pull - Antique Brass Anodized	-HP-ABA	Pull to open. Applied to all doors.	\$230	\$345	\$460	\$575
Handle Pull - Light Bronze Anodized	-HP-LBA	Pull to open. Applied to all doors.	\$230	\$345	\$460	\$575



FENIX® TOP WITH SQUARE EDGE

PUSH LATCH OR HANDLE PULL OPTIONS	CODE	PRICE	NOTES
Locks	Add -LK	\$315	Locks included in all cabinets
Polished Chrome Base	Add -PCCB	\$1,775	
Wire Frame Pull-Out Waste/Recycling Unit Conference and Buffet Height Credenzas (excludes 36" width)			
(1) 20" Depth Single Wire Frame Unit	Add -TF1	\$309	Located in the rightmost cabinet, behind the right door
(1) 24" Depth Double Wire Frame Unit	Add -TF2	\$477	Located in the rightmost cabinet, behind the right door
Dual Wire Frame Pull-Out Waste/Recycling Units Conference and Buffet Height Credenzas (Excludes 36"-54" width)			
(2) 20" Depth Single Wire Frame Units	Add -TF3	\$617	Located in the rightmost cabinet, behind left and right doors
(2) 24" Depth Double Wire Frame Units	Add -TF4	\$954	Located in the rightmost cabinet, behind left and right doors
24" Depth Equipment Rack Options Available on Buffet Height Credenzas			
Fixed Equipment Rack	Add -R2	\$947	Located in left most cabinet, behind left and right doors
Sliding Equipment Rack	Add -R1	\$3,467	Located in left most cabinet, behind left and right doors

ADDITIONAL HANDLE PULL OPTIONS

Wood Frame Pull-Out Waste/Recycling Bin Unit Conference and Buffet Height Credenzas (Excludes 36" width)			
(1) 20" Depth Single Wood Frame Unit	Add -FWTF1	\$817	Located in the rightmost cabinet, applied to right door
(1) 24" Depth Double Wood Frame Unit	Add -FWTF2	\$1,225	Located in the rightmost cabinet, applied to right door
Dual Wood Frame Pull-Out Waste/Recycling Bin Unit Conference and Buffet Height Credenzas (Excludes 36"-54" width)			
(2) 20" Depth Single Wood Frame Units	Add -FWTF3	\$1,633	Located in the rightmost cabinet, applied to left and right doors
(2) 24" Depth Double Wood Frame Units	Add -FWTF4	\$2,450	Located in the rightmost cabinet, applied to left and right doors
24" Depth Single Pull-Out Drawer Refrigerator Available on Conference and Buffet Height Credenzas			
Pull-Out Drawer Refrigerator	Add -FWOM24	\$7,327	Located in left most cabinet, includes applied door panel

EDGE PROFILE



Square Edge

REQUIRED INFORMATION (ORDER CANNOT BE ENTERED WITHOUT THIS INFORMATION)

See appendix pages vi-viii for surface material options.

- Choose Door Style: Defaults to case finish, if none selected
- Choose Pull Style: Defaults to Push Latch, if none selected
- Choose Metal Finish
- Choose Paint Finish, if specified
- Choose Veneer Finish
- Choose Fenix: Defaults to coordinating edge band

GENERAL INFORMATION

- Tops are 3/4" -thick with a 2 mm edge
- When veneer case is specified, the case exterior is standard slip-match layout regardless of veneer door style selection
- Pull-Out Waste/Recycling Bin size: 17-7/8" x 8-3/32" x 11-9/16"; (1) 35 Qt.; Double Pull-Out Waste/Recycling Units include two bins
- When lock option is specified, color will default based on leg finish:
 - Aged Bronze, Black, Galaxy, Shadow, and Storm: Black
 - Cloud: White
 - Burnish, Foil, and Satin Bronze: Satin Nickel
 - Chrome: Polished Nickel
- Credenzas include one adjustable shelf behind each door unless other components are specified
- Equipment racks hold 12RU and include a thermostatically controlled fan and plug strip



FENIX® TOP WITH SQUARE EDGE

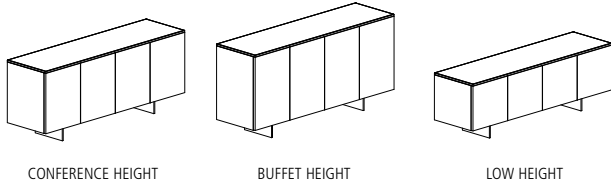

CASE MATERIAL KEY

PA-BB Painted Case with Blade Base
 V-BB Veneer Case with Blade Base

BLADE BASE

MODEL #	W x D x H	DESCRIPTION	-PA-BB	-V-BB
CONFERENCE HEIGHT (24 IN. CASE WITH 6 IN. BLADE BASE)				
FWLC-3629-XE	36 x 20 x 30	Two Doors	6,513	6,513
FWLC-5429-XE	54 x 20 x 30	Three Doors	8,213	8,213
FWLC-7229-XE	72 x 20 x 30	Four Doors	9,918	9,918
FWLC-9029-XE	90 x 20 x 30	Five Doors	11,625	11,625
FWLD-3629-XE	36 x 24 x 30	Two Doors	7,078	7,078
FWLD-5429-XE	54 x 24 x 30	Three Doors	8,951	8,951
FWLD-7229-XE	72 x 24 x 30	Four Doors	10,826	10,826
FWLD-9029-XE	90 x 24 x 30	Five Doors	12,699	12,699
BUFFET HEIGHT (29 IN. CASE WITH 6 IN. BLADE BASE)				
FWCC-3636-XE	36 x 20 x 35	Two Doors	6,963	6,963
FWCC-5436-XE	54 x 20 x 35	Three Doors	8,802	8,802
FWCC-7236-XE	72 x 20 x 35	Four Doors	10,641	10,641
FWCC-9036-XE	90 x 20 x 35	Five Doors	12,482	12,482
FWCD-3636-XE	36 x 24 x 35	Two Doors	7,572	7,572
FWCD-5436-XE	54 x 24 x 35	Three Doors	9,598	9,598
FWCD-7236-XE	72 x 24 x 35	Four Doors	11,621	11,621
FWCD-9036-XE	90 x 24 x 35	Five Doors	13,644	13,644
LOW HEIGHT (18 IN. CASE WITH 6 IN. BLADE BASE)				
FWWC-3624-XE	36 x 20 x 24	Two Doors	6,049	6,049
FWWC-5424-XE	54 x 20 x 24	Three Doors	7,616	7,616
FWWC-7224-XE	72 x 20 x 24	Four Doors	9,179	9,179
FWWC-9024-XE	90 x 20 x 24	Five Doors	10,739	10,739

DOOR STYLE

DESCRIPTION	CODE	NOTES	PRICE
Vertical Veneer	-VD		No Charge
Horizontal Veneer	-HD		No Charge

PULL STYLE

DESCRIPTION	CODE	NOTES	TWO DOOR	THREE DOOR	FOUR DOOR	FIVE DOOR
Push Latch	No Code	Push to open (no pull). Applied to all doors.	No Charge	No Charge	No Charge	No Charge
Handle Pull - Powder Coat	-HP	Pull to open. Applied to all doors.	\$157	\$236	\$314	\$392
Handle Pull - High Polish Finish	-HP-HPF	Pull to open. Applied to all doors.	\$277	\$416	\$554	\$693
Handle Pull - Clear Anodized	-HP-CA	Pull to open. Applied to all doors.	\$157	\$236	\$314	\$392
Handle Pull - Goldmatt Anodized	-HP-GMA	Pull to open. Applied to all doors.	\$230	\$345	\$460	\$575
Handle Pull - Antique Brass Anodized	-HP-ABA	Pull to open. Applied to all doors.	\$230	\$345	\$460	\$575
Handle Pull - Light Bronze Anodized	-HP-LBA	Pull to open. Applied to all doors.	\$230	\$345	\$460	\$575



FENIX® TOP WITH SQUARE EDGE

PUSH LATCH OR HANDLE PULL OPTIONS	CODE	PRICE	NOTES
Locks	Add -LK	\$315	Locks included in all cabinets
Polished Chrome Base	Add -PCBB	\$501	
Wire Frame Pull-Out Waste/Recycling Unit Conference and Buffet Height Credenzas (excludes 36" width)			
(1) 20" Depth Single Wire Frame Unit	Add -TF1	\$309	Located in the rightmost cabinet, behind the right door
(1) 24" Depth Double Wire Frame Unit	Add -TF2	\$477	Located in the rightmost cabinet, behind the right door
Dual Wire Frame Pull-Out Waste/Recycling Units Conference and Buffet Height Credenzas (Excludes 36"-54" width)			
(2) 20" Depth Single Wire Frame Units	Add -TF3	\$617	Located in the rightmost cabinet, behind left and right doors
(2) 24" Depth Double Wire Frame Units	Add -TF4	\$954	Located in the rightmost cabinet, behind left and right doors
24" Depth Equipment Rack Options Available on Buffet Height Credenzas			
Fixed Equipment Rack	Add -R2	\$947	Located in left most cabinet, behind left and right doors
Sliding Equipment Rack	Add -R1	\$3,467	Located in left most cabinet, behind left and right doors

ADDITIONAL HANDLE PULL OPTIONS

Wood Frame Pull-Out Waste/Recycling Bin Unit Conference and Buffet Height Credenzas (Excludes 36" width)			
(1) 20" Depth Single Wood Frame Unit	Add -FWTF1	\$817	Located in the rightmost cabinet, applied to right door
(1) 24" Depth Double Wood Frame Unit	Add -FWTF2	\$1,225	Located in the rightmost cabinet, applied to right door
Dual Wood Frame Pull-Out Waste/Recycling Bin Unit Conference and Buffet Height Credenzas (Excludes 36"-54" width)			
(2) 20" Depth Single Wood Frame Units	Add -FWTF3	\$1,633	Located in the rightmost cabinet, applied to left and right doors
(2) 24" Depth Double Wood Frame Units	Add -FWTF4	\$2,450	Located in the rightmost cabinet, applied to left and right doors
24" Depth Single Pull-Out Drawer Refrigerator Available on Conference and Buffet Height Credenzas			
Pull-Out Drawer Refrigerator	Add -FWOM24	\$7,327	Located in left most cabinet, includes applied door panel

EDGE PROFILE



Square Edge

REQUIRED INFORMATION (ORDER CANNOT BE ENTERED WITHOUT THIS INFORMATION)

See appendix pages vi-viii for surface material options.

- Choose Door Style: Defaults to case finish, if none selected
- Choose Pull Style: Defaults to Push Latch, if none selected
- Choose Metal Finish
- Choose Paint Finish, if specified
- Choose Veneer Finish
- Choose Fenix: Defaults to coordinating edge band

GENERAL INFORMATION

- Tops are 3/4" -thick with a 2 mm edge
- When veneer case is specified, the case exterior is standard slip-match layout regardless of veneer door style selection
- Pull-Out Waste/Recycling Bin size: 17-7/8" x 8-3/32" x 11-9/16"; (1) 35 Qt.; Double Pull-Out Waste/Recycling Units include two bins
- When lock option is specified, color will default based on leg finish:
 - Aged Bronze, Black, Galaxy, Shadow, and Storm: Black
 - Cloud: White
 - Burnish, Foil, and Satin Bronze: Satin Nickel
 - Chrome: Polished Nickel
- Credenzas include one adjustable shelf behind each door unless other components are specified
- Equipment racks hold 12RU and include a thermostatically controlled fan and plug strip



LAMINATE TOP WITH HARDWOOD EDGE

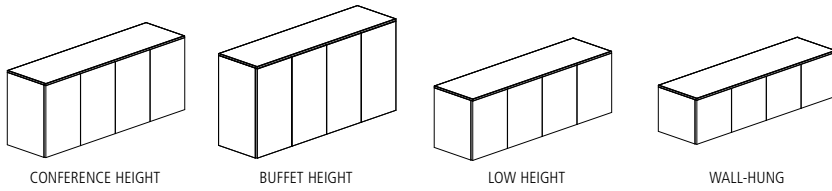

CASE MATERIAL KEY

V Veneer Case

CASE ONLY

MODEL #	W x D x H	DESCRIPTION	-V
CONFERENCE HEIGHT (29.5 INCH CASE)			
FWCC-3629-W-P	36 x 20 x 29.5	Two Doors	5,716
FWCC-5429-W-P	54 x 20 x 29.5	Three Doors	7,437
FWCC-7229-W-P	72 x 20 x 29.5	Four Doors	9,164
FWCC-9029-W-P	90 x 20 x 29.5	Five Doors	10,890
FWCD-3629-W-P	36 x 24 x 29.5	Two Doors	6,284
FWCD-5429-W-P	54 x 24 x 29.5	Three Doors	8,181
FWCD-7229-W-P	72 x 24 x 29.5	Four Doors	10,081
FWCD-9029-W-P	90 x 24 x 29.5	Five Doors	11,977
BUFFET HEIGHT (36.5 INCH CASE)			
FWBC-3636-W-P	36 x 20 x 36.5	Two Doors	6,569
FWBC-5436-W-P	54 x 20 x 36.5	Three Doors	8,550
FWBC-7236-W-P	72 x 20 x 36.5	Four Doors	10,534
FWBC-9036-W-P	90 x 20 x 36.5	Five Doors	12,521
FWBD-3636-W-P	36 x 24 x 36.5	Two Doors	7,226
FWBD-5436-W-P	54 x 24 x 36.5	Three Doors	9,405
FWBD-7236-W-P	72 x 24 x 36.5	Four Doors	11,587
FWBD-9036-W-P	90 x 24 x 36.5	Five Doors	13,772
LOW HEIGHT (24.5 INCH CASE)			
FWLC-3624-W-P	36 x 20 x 24.5	Two Doors	5,293
FWLC-5424-W-P	54 x 20 x 24.5	Three Doors	6,888
FWLC-7224-W-P	72 x 20 x 24.5	Four Doors	8,488
FWLC-9024-W-P	90 x 20 x 24.5	Five Doors	10,085
FWLD-3624-W-P	36 x 24 x 24.5	Two Doors	5,821
FWLD-5424-W-P	54 x 24 x 24.5	Three Doors	7,576
FWLD-7224-W-P	72 x 24 x 24.5	Four Doors	9,333
FWLD-9024-W-P	90 x 24 x 24.5	Five Doors	11,091
WALL-HUNG (18 INCH CASE)			
FWWC-3618-W-P	36 x 20 x 18	Two Doors	4,857
FWWC-5418-W-P	54 x 20 x 18	Three Doors	6,324
FWWC-7218-W-P	72 x 20 x 18	Four Doors	7,790
FWWC-9018-W-P	90 x 20 x 18	Five Doors	9,256

DOOR STYLE

DESCRIPTION	CODE	NOTES	PRICE
Vertical Veneer	-VD		No Charge
Horizontal Veneer	-HD		No Charge

PULL STYLE

DESCRIPTION	CODE	NOTES	TWO DOOR	THREE DOOR	FOUR DOOR	FIVE DOOR
Push Latch	No Code	Push to open (no pull). Applied to all doors.	No Charge	No Charge	No Charge	No Charge
Handle Pull - Powder Coat	-HP	Pull to open. Applied to all doors.	\$157	\$236	\$314	\$392
Handle Pull - High Polish Finish	-HP-HPF	Pull to open. Applied to all doors.	\$277	\$416	\$554	\$693
Handle Pull - Clear Anodized	-HP-CA	Pull to open. Applied to all doors.	\$157	\$236	\$314	\$392
Handle Pull - Goldmatt Anodized	-HP-GMA	Pull to open. Applied to all doors.	\$230	\$345	\$460	\$575
Handle Pull - Antique Brass Anodized	-HP-ABA	Pull to open. Applied to all doors.	\$230	\$345	\$460	\$575
Handle Pull - Light Bronze Anodized	-HP-LBA	Pull to open. Applied to all doors.	\$230	\$345	\$460	\$575



LAMINATE TOP WITH HARDWOOD EDGE

PUSH LATCH OR HANDLE PULL OPTIONS	CODE	PRICE	NOTES
Locks	Add -LK	\$315	Locks included in all cabinets
Drawers Behind Doors	Add -D	\$614	Available on Buffet Height Credenza
Wire Frame Pull-Out Waste/Recycling Unit Conference, Buffet, and Low Height Credenzas (excludes 36" width)			
(1) 20" Depth Single Wire Frame Unit	Add -TF1	\$309	Located in the rightmost cabinet, behind the right door
(1) 24" Depth Double Wire Frame Unit	Add -TF2	\$477	Located in the rightmost cabinet, behind the right door
Dual Wire Frame Pull-Out Waste/Recycling Units Conference, Buffet, and Low Height Credenzas (Excludes 36"-54" width)			
(2) 20" Depth Single Wire Frame Units	Add -TF3	\$617	Located in the rightmost cabinet, behind left and right doors
(2) 24" Depth Double Wire Frame Units	Add -TF4	\$954	Located in the rightmost cabinet, behind left and right doors
24" Depth Equipment Rack Options Available on Conference and Buffet Height Credenzas			
Fixed Equipment Rack	Add -R2	\$947	Located in left most cabinet, behind left and right doors
Sliding Equipment Rack	Add -R1	\$3,467	Located in left most cabinet, behind left and right doors

ADDITIONAL HANDLE PULL OPTIONS

Wood Frame Pull-Out Waste/Recycling Bin Unit Conference, Buffet, and Low Height Credenzas (Excludes 36" width)			
(1) 20" Depth Single Wood Frame Unit	Add -FWTF1	\$817	Located in the rightmost cabinet, applied to right door
(1) 24" Depth Double Wood Frame Unit	Add -FWTF2	\$1,225	Located in the rightmost cabinet, applied to right door
Dual Wood Frame Pull-Out Waste/Recycling Bin Unit Conference, Buffet, and Low Height Credenzas (Excludes 36"-54" width)			
(2) 20" Depth Single Wood Frame Units	Add -FWTF3	\$1,633	Located in the rightmost cabinet, applied to left and right doors
(2) 24" Depth Double Wood Frame Units	Add -FWTF4	\$2,450	Located in the rightmost cabinet, applied to left and right doors
24" Depth Single Pull-Out Drawer Refrigerator Available on Conference and Low Height Credenzas			
Pull-Out Drawer Refrigerator	Add -FWOM24	\$7,327	Located in left most cabinet, includes applied door panel

EDGE PROFILE



Square Edge

REQUIRED INFORMATION (ORDER CANNOT BE ENTERED WITHOUT THIS INFORMATION)

See appendix pages vi-viii for surface material options.

- Choose Door Style: Defaults to case finish, if none selected
- Choose Pull Style: Defaults to Push Latch, if none selected
- Choose Veneer Finish
- Choose Laminate

GENERAL INFORMATION

- Tops are 3/4" -thick with 3/16" -deep hardwood edge band
- When veneer case is specified, the case exterior is standard slip-match layout regardless of veneer door style selection
- Pull-Out Waste/Recycling Bin size: 17-7/8" x 8-3/32" x 11-9/16"; (1) 35 Qt.; Double Pull-Out Waste/Recycling Units include two bins
- Locks
 - Veneer (Case Only) - When lock option is specified, color will default to Satin Nickel
- Credenzas include one adjustable shelf behind each door unless other components are specified
- Equipment racks hold 12RU and include a thermostatically controlled fan and plug strip



LAMINATE TOP WITH HARDWOOD EDGE

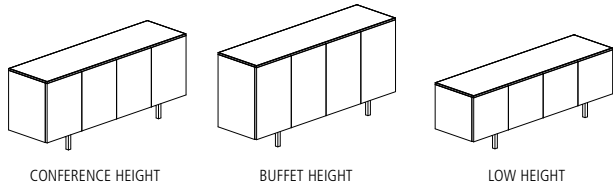

CASE MATERIAL KEY

V-IB Veneer Case with Inset Leg

INSET LEG

MODEL #	W x D x H	DESCRIPTION	-V-IB
CONFERENCE HEIGHT (24 IN. CASE WITH 6.5 IN. INSET LEG)			
FWLC-3629-W-P	36 x 20 x 30.5	Two Doors	5,759
FWLC-5429-W-P	54 x 20 x 30.5	Three Doors	7,354
FWLC-7229-W-P	72 x 20 x 30.5	Four Doors	8,952
FWLC-9029-W-P	90 x 20 x 30.5	Five Doors	10,550
FWLD-3629-W-P	36 x 24 x 30.5	Two Doors	6,284
FWLD-5429-W-P	54 x 24 x 30.5	Three Doors	8,040
FWLD-7229-W-P	72 x 24 x 30.5	Four Doors	9,798
FWLD-9029-W-P	90 x 24 x 30.5	Five Doors	11,557
BUFFET HEIGHT (29 IN. CASE WITH 6.5 IN. INSET LEG)			
FWCC-3636-W-P	36 x 20 x 35.5	Two Doors	6,180
FWCC-5436-W-P	54 x 20 x 35.5	Three Doors	7,903
FWCC-7236-W-P	72 x 20 x 35.5	Four Doors	9,630
FWCC-9036-W-P	90 x 20 x 35.5	Five Doors	11,354
FWCD-3636-W-P	36 x 24 x 35.5	Two Doors	6,751
FWCD-5436-W-P	54 x 24 x 35.5	Three Doors	8,645
FWCD-7236-W-P	72 x 24 x 35.5	Four Doors	10,541
FWCD-9036-W-P	90 x 24 x 35.5	Five Doors	12,442
LOW HEIGHT (18 IN. CASE WITH 6.5 IN. INSET LEG)			
FWWC-3624-W-P	36 x 20 x 24.5	Two Doors	5,324
FWWC-5424-W-P	54 x 20 x 24.5	Three Doors	6,789
FWWC-7224-W-P	72 x 20 x 24.5	Four Doors	8,253
FWWC-9024-W-P	90 x 20 x 24.5	Five Doors	9,723

DOOR STYLE

DESCRIPTION	CODE	NOTES	PRICE
Vertical Veneer	-VD		No Charge
Horizontal Veneer	-HD		No Charge

PULL STYLE

DESCRIPTION	CODE	NOTES	TWO DOOR	THREE DOOR	FOUR DOOR	FIVE DOOR
Push Latch	No Code	Push to open (no pull). Applied to all doors.	No Charge	No Charge	No Charge	No Charge
Handle Pull - Powder Coat	-HP	Pull to open. Applied to all doors.	\$157	\$236	\$314	\$392
Handle Pull - High Polish Finish	-HP-HPF	Pull to open. Applied to all doors.	\$277	\$416	\$554	\$693
Handle Pull - Clear Anodized	-HP-CA	Pull to open. Applied to all doors.	\$157	\$236	\$314	\$392
Handle Pull - Goldmatt Anodized	-HP-GMA	Pull to open. Applied to all doors.	\$230	\$345	\$460	\$575
Handle Pull - Antique Brass Anodized	-HP-ABA	Pull to open. Applied to all doors.	\$230	\$345	\$460	\$575
Handle Pull - Light Bronze Anodized	-HP-LBA	Pull to open. Applied to all doors.	\$230	\$345	\$460	\$575



LAMINATE TOP WITH HARDWOOD EDGE

PUSH LATCH OR HANDLE PULL OPTIONS	CODE	PRICE	NOTES
Locks	Add -LK	\$315	Locks included in all cabinets
Polished Chrome Base	Add -PCIB	\$501	
Wire Frame Pull-Out Waste/Recycling Unit Conference and Buffet Height Credenzas (excludes 36" width)			
(1) 20" Depth Single Wire Frame Unit	Add -TF1	\$309	Located in the rightmost cabinet, behind the right door
(1) 24" Depth Double Wire Frame Unit	Add -TF2	\$477	Located in the rightmost cabinet, behind the right door
Dual Wire Frame Pull-Out Waste/Recycling Units Conference and Buffet Height Credenzas (Excludes 36"-54" width)			
(2) 20" Depth Single Wire Frame Units	Add -TF3	\$617	Located in the rightmost cabinet, behind left and right doors
(2) 24" Depth Double Wire Frame Units	Add -TF4	\$954	Located in the rightmost cabinet, behind left and right doors
24" Depth Equipment Rack Options Available on Buffet Height Credenzas			
Fixed Equipment Rack	Add -R2	\$947	Located in left most cabinet, behind left and right doors
Sliding Equipment Rack	Add -R1	\$3,467	Located in left most cabinet, behind left and right doors

ADDITIONAL HANDLE PULL OPTIONS

Wood Frame Pull-Out Waste/Recycling Bin Unit Conference and Buffet Height Credenzas (Excludes 36" width)			
(1) 20" Depth Single Wood Frame Unit	Add -FWTF1	\$817	Located in the rightmost cabinet, applied to right door
(1) 24" Depth Double Wood Frame Unit	Add -FWTF2	\$1,225	Located in the rightmost cabinet, applied to right door
Dual Wood Frame Pull-Out Waste/Recycling Bin Unit Conference and Buffet Height Credenzas (Excludes 36"-54" width)			
(2) 20" Depth Single Wood Frame Units	Add -FWTF3	\$1,633	Located in the rightmost cabinet, applied to left and right doors
(2) 24" Depth Double Wood Frame Units	Add -FWTF4	\$2,450	Located in the rightmost cabinet, applied to left and right doors
24" Depth Single Pull-Out Drawer Refrigerator Available on Conference and Buffet Height Credenzas			
Pull-Out Drawer Refrigerator	Add -FWOM24	\$7,327	Located in left most cabinet, includes applied door panel

EDGE PROFILE



Square Edge

REQUIRED INFORMATION (ORDER CANNOT BE ENTERED WITHOUT THIS INFORMATION)

See appendix pages vi-viii for surface material options.

- Choose Door Style: Defaults to case finish, if none selected
- Choose Pull Style: Defaults to Push Latch, if none selected
- Choose Metal Finish
- Choose Veneer Finish
- Choose Laminate

GENERAL INFORMATION

- Tops are 3/4"-thick with 3/16"-deep hardwood edge band
- When veneer case is specified, the case exterior is standard slip-match layup regardless of veneer door style selection
- Pull-Out Waste/Recycling Bin size: 17-7/8" x 8-3/32" x 11-9/16"; (1) 35 Qt.; Double Pull-Out Waste/Recycling Units include two bins
- When lock option is specified, color will default based on leg finish:
 - Aged Bronze, Black, Galaxy, Shadow, and Storm: Black
 - Cloud: White
 - Burnish, Foil, and Satin Bronze: Satin Nickel
 - Chrome: Polished Nickel
- Credenzas include one adjustable shelf behind each door unless other components are specified
- Equipment racks hold 12RU and include a thermostatically controlled fan and plug strip



LAMINATE TOP WITH HARDWOOD EDGE

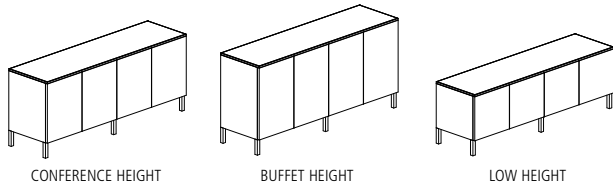

CASE MATERIAL KEY

V-OB Veneer Case with Edge-mount Post Leg

EDGE-MOUNT POST LEG

MODEL #	W x D x H	DESCRIPTION	-V-OB
CONFERENCE HEIGHT (24 IN. CASE WITH 6.5 IN. EDGE-MOUNT POST LEG)			
FWLC-3629-W-P	36 x 20 x 30.5	Two Door	5,759
FWLC-5429-W-P	54 x 20 x 30.5	Three Door	7,354
FWLC-7229-W-P	72 x 20 x 30.5	Four Door	8,952
FWLC-9029-W-P	90 x 20 x 30.5	Five Door	10,550
FWLD-3629-W-P	36 x 24 x 30.5	Two Door	6,284
FWLD-5429-W-P	54 x 24 x 30.5	Three Door	8,040
FWLD-7229-W-P	72 x 24 x 30.5	Four Door	9,798
FWLD-9029-W-P	90 x 24 x 30.5	Five Door	11,557
BUFFET HEIGHT (29 IN. CASE WITH 6.5 IN. EDGE-MOUNT POST LEG)			
FWCC-3636-W-P	36 x 20 x 35.5	Two Door	6,180
FWCC-5436-W-P	54 x 20 x 35.5	Three Door	7,903
FWCC-7236-W-P	72 x 20 x 35.5	Four Door	9,630
FWCC-9036-W-P	90 x 20 x 35.5	Five Door	11,354
FWCD-3636-W-P	36 x 24 x 35.5	Two Door	6,751
FWCD-5436-W-P	54 x 24 x 35.5	Three Door	8,645
FWCD-7236-W-P	72 x 24 x 35.5	Four Door	10,541
FWCD-9036-W-P	90 x 24 x 35.5	Five Door	12,442
LOW HEIGHT (18 IN. CASE WITH 6.5 IN. EDGE-MOUNT POST LEG)			
FWWC-3624-W-P	36 x 20 x 24.5	Two Door	5,324
FWWC-5424-W-P	54 x 20 x 24.5	Three Door	6,789
FWWC-7224-W-P	72 x 20 x 24.5	Four Door	8,253
FWWC-9024-W-P	90 x 20 x 24.5	Five Door	9,723

DOOR STYLE

DESCRIPTION	CODE	NOTES	PRICE
Vertical Veneer	-VD		No Charge
Horizontal Veneer	-HD		No Charge

PULL STYLE

DESCRIPTION	CODE	NOTES	TWO DOOR	THREE DOOR	FOUR DOOR	FIVE DOOR
Push Latch	No Code	Push to open (no pull). Applied to all doors.	No Charge	No Charge	No Charge	No Charge
Handle Pull - Powder Coat	-HP	Pull to open. Applied to all doors.	\$157	\$236	\$314	\$392
Handle Pull - High Polish Finish	-HP-HPF	Pull to open. Applied to all doors.	\$277	\$416	\$554	\$693
Handle Pull - Clear Anodized	-HP-CA	Pull to open. Applied to all doors.	\$157	\$236	\$314	\$392
Handle Pull - Goldmatt Anodized	-HP-GMA	Pull to open. Applied to all doors.	\$230	\$345	\$460	\$575
Handle Pull - Antique Brass Anodized	-HP-ABA	Pull to open. Applied to all doors.	\$230	\$345	\$460	\$575
Handle Pull - Light Bronze Anodized	-HP-LBA	Pull to open. Applied to all doors.	\$230	\$345	\$460	\$575



LAMINATE TOP WITH HARDWOOD EDGE

PUSH LATCH OR HANDLE PULL OPTIONS	CODE	PRICE	NOTES
Locks	Add -LK	\$315	Locks included in all cabinets
Polished Chrome Base	Add -PCOB	\$541	
Wire Frame Pull-Out Waste/Recycling Unit Conference and Buffet Height Credenzas (excludes 36" width)			
(1) 20" Depth Single Wire Frame Unit	Add -TF1	\$309	Located in the rightmost cabinet, behind the right door
(1) 24" Depth Double Wire Frame Unit	Add -TF2	\$477	Located in the rightmost cabinet, behind the right door
Dual Wire Frame Pull-Out Waste/Recycling Units Conference and Buffet Height Credenzas (Excludes 36"-54" width)			
(2) 20" Depth Single Wire Frame Units	Add -TF3	\$617	Located in the rightmost cabinet, behind left and right doors
(2) 24" Depth Double Wire Frame Units	Add -TF4	\$954	Located in the rightmost cabinet, behind left and right doors
24" Depth Equipment Rack Options Available on Buffet Height Credenzas			
Fixed Equipment Rack	Add -R2	\$947	Located in left most cabinet, behind left and right doors
Sliding Equipment Rack	Add -R1	\$3,467	Located in left most cabinet, behind left and right doors

ADDITIONAL HANDLE PULL OPTIONS

Wood Frame Pull-Out Waste/Recycling Bin Unit Conference and Buffet Height Credenzas (Excludes 36" width)			
(1) 20" Depth Single Wood Frame Unit	Add -FWTF1	\$817	Located in the rightmost cabinet, applied to right door
(1) 24" Depth Double Wood Frame Unit	Add -FWTF2	\$1,225	Located in the rightmost cabinet, applied to right door
Dual Wood Frame Pull-Out Waste/Recycling Bin Unit Conference and Buffet Height Credenzas (Excludes 36"-54" width)			
(2) 20" Depth Single Wood Frame Units	Add -FWTF3	\$1,633	Located in the rightmost cabinet, applied to left and right doors
(2) 24" Depth Double Wood Frame Units	Add -FWTF4	\$2,450	Located in the rightmost cabinet, applied to left and right doors
24" Depth Single Pull-Out Drawer Refrigerator Available on Conference and Buffet Height Credenzas			
Pull-Out Drawer Refrigerator	Add -FWOM24	\$7,327	Located in left most cabinet, includes applied door panel

EDGE PROFILE



Square Edge

REQUIRED INFORMATION (ORDER CANNOT BE ENTERED WITHOUT THIS INFORMATION)

See appendix pages vi-viii for surface material options.

- Choose Door Style: Defaults to case finish, if none selected
- Choose Pull Style: Defaults to Push Latch, if none selected
- Choose Metal Finish
- Choose Veneer Finish
- Choose Laminate

GENERAL INFORMATION

- Tops are 3/4"-thick with 3/16"-deep hardwood edge band
- When veneer case is specified, the case exterior is standard slip-match layup regardless of veneer door style selection
- Pull-Out Waste/Recycling Bin size: 17-7/8" x 8-3/32" x 11-9/16"; (1) 35 Qt.; Double Pull-Out Waste/Recycling Units include two bins
- When lock option is specified, color will default based on leg finish:
 - Aged Bronze, Black, Galaxy, Shadow, and Storm: Black
 - Cloud: White
 - Burnish, Foil, and Satin Bronze: Satin Nickel
 - Chrome: Polished Nickel
- Credenzas include one adjustable shelf behind each door unless other components are specified
- Equipment racks hold 12RU and include a thermostatically controlled fan and plug strip



LAMINATE TOP WITH HARDWOOD EDGE

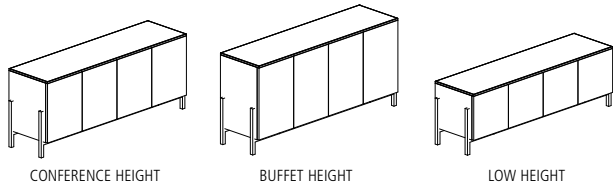

CASE MATERIAL KEY

V-CB Veneer Case with Cradle Base

CRADLE BASE

MODEL #	W x D x H	DESCRIPTION	-V-CB
CONFERENCE HEIGHT (24 IN. CASE WITH 6.5 IN. CRADLE BASE)			
FWLC-3629-W-P	36 x 20 x 30.5	Two Doors	6,378
FWLC-5429-W-P	54 x 20 x 30.5	Three Doors	7,973
FWLC-7229-W-P	72 x 20 x 30.5	Four Doors	9,574
FWLC-9029-W-P	90 x 20 x 30.5	Five Doors	11,171
FWLD-3629-W-P	36 x 24 x 30.5	Two Doors	6,905
FWLD-5429-W-P	54 x 24 x 30.5	Three Doors	8,661
FWLD-7229-W-P	72 x 24 x 30.5	Four Doors	10,417
FWLD-9029-W-P	90 x 24 x 30.5	Five Doors	12,177
BUFFET HEIGHT (29 IN. CASE WITH 6.5 IN. CRADLE BASE)			
FWCC-3636-W-P	36 x 20 x 35.5	Two Doors	6,800
FWCC-5436-W-P	54 x 20 x 35.5	Three Doors	8,521
FWCC-7236-W-P	72 x 20 x 35.5	Four Doors	10,250
FWCC-9036-W-P	90 x 20 x 35.5	Five Doors	11,974
FWCD-3636-W-P	36 x 24 x 35.5	Two Doors	7,370
FWCD-5436-W-P	54 x 24 x 35.5	Three Doors	9,265
FWCD-7236-W-P	72 x 24 x 35.5	Four Doors	11,162
FWCD-9036-W-P	90 x 24 x 35.5	Five Doors	13,065
LOW HEIGHT (18 IN. CASE WITH 6.5 IN. CRADLE BASE)			
FWWC-3624-W-P	36 x 20 x 24.5	Two Doors	5,942
FWWC-5424-W-P	54 x 20 x 24.5	Three Doors	7,409
FWWC-7224-W-P	72 x 20 x 24.5	Four Doors	8,874
FWWC-9024-W-P	90 x 20 x 24.5	Five Doors	10,342

DOOR STYLE

DESCRIPTION	CODE	NOTES	PRICE
Vertical Veneer	-VD		No Charge
Horizontal Veneer	-HD		No Charge

PULL STYLE

DESCRIPTION	CODE	NOTES	TWO DOOR	THREE DOOR	FOUR DOOR	FIVE DOOR
Push Latch	No Code	Push to open (no pull). Applied to all doors.	No Charge	No Charge	No Charge	No Charge
Handle Pull - Powder Coat	-HP	Pull to open. Applied to all doors.	\$157	\$236	\$314	\$392
Handle Pull - High Polish Finish	-HP-HPF	Pull to open. Applied to all doors.	\$277	\$416	\$554	\$693
Handle Pull - Clear Anodized	-HP-CA	Pull to open. Applied to all doors.	\$157	\$236	\$314	\$392
Handle Pull - Goldmatt Anodized	-HP-GMA	Pull to open. Applied to all doors.	\$230	\$345	\$460	\$575
Handle Pull - Antique Brass Anodized	-HP-ABA	Pull to open. Applied to all doors.	\$230	\$345	\$460	\$575
Handle Pull - Light Bronze Anodized	-HP-LBA	Pull to open. Applied to all doors.	\$230	\$345	\$460	\$575



LAMINATE TOP WITH HARDWOOD EDGE

PUSH LATCH OR HANDLE PULL OPTIONS	CODE	PRICE	NOTES
Locks	Add -LK	\$315	Locks included in all cabinets
Polished Chrome Base	Add -PCCB	\$1,775	
Wire Frame Pull-Out Waste/Recycling Unit Conference and Buffet Height Credenzas (excludes 36" width)			
(1) 20" Depth Single Wire Frame Unit	Add -TF1	\$309	Located in the rightmost cabinet, behind the right door
(1) 24" Depth Double Wire Frame Unit	Add -TF2	\$477	Located in the rightmost cabinet, behind the right door
Dual Wire Frame Pull-Out Waste/Recycling Units Conference and Buffet Height Credenzas (Excludes 36"-54" width)			
(2) 20" Depth Single Wire Frame Units	Add -TF3	\$617	Located in the rightmost cabinet, behind left and right doors
(2) 24" Depth Double Wire Frame Units	Add -TF4	\$954	Located in the rightmost cabinet, behind left and right doors
24" Depth Equipment Rack Options Available on Buffet Height Credenzas			
Fixed Equipment Rack	Add -R2	\$947	Located in left most cabinet, behind left and right doors
Sliding Equipment Rack	Add -R1	\$3,467	Located in left most cabinet, behind left and right doors

ADDITIONAL HANDLE PULL OPTIONS

Wood Frame Pull-Out Waste/Recycling Bin Unit Conference and Buffet Height Credenzas (Excludes 36" width)			
(1) 20" Depth Single Wood Frame Unit	Add -FWTF1	\$817	Located in the rightmost cabinet, applied to right door
(1) 24" Depth Double Wood Frame Unit	Add -FWTF2	\$1,225	Located in the rightmost cabinet, applied to right door
Dual Wood Frame Pull-Out Waste/Recycling Bin Unit Conference and Buffet Height Credenzas (Excludes 36"-54" width)			
(2) 20" Depth Single Wood Frame Units	Add -FWTF3	\$1,633	Located in the rightmost cabinet, applied to left and right doors
(2) 24" Depth Double Wood Frame Units	Add -FWTF4	\$2,450	Located in the rightmost cabinet, applied to left and right doors
24" Depth Single Pull-Out Drawer Refrigerator Available on Conference and Buffet Height Credenzas			
Pull-Out Drawer Refrigerator	Add -FWOM24	\$7,327	Located in left most cabinet, includes applied door panel

EDGE PROFILE



Square Edge

REQUIRED INFORMATION (ORDER CANNOT BE ENTERED WITHOUT THIS INFORMATION)

See appendix pages vi-viii for surface material options.

- Choose Door Style: Defaults to case finish, if none selected
- Choose Pull Style: Defaults to Push Latch, if none selected
- Choose Metal Finish
- Choose Veneer Finish
- Choose Laminate

GENERAL INFORMATION

- Tops are 3/4"-thick with 3/16"-deep hardwood edge band
- When veneer case is specified, the case exterior is standard slip-match layup regardless of veneer door style selection
- Pull-Out Waste/Recycling Bin size: 17-7/8" x 8-3/32" x 11-9/16"; (1) 35 Qt.; Double Pull-Out Waste/Recycling Units include two bins
- When lock option is specified, color will default based on leg finish:
 - Aged Bronze, Black, Galaxy, Shadow, and Storm: Black
 - Cloud: White
 - Burnish, Foil, and Satin Bronze: Satin Nickel
 - Chrome: Polished Nickel
- Credenzas include one adjustable shelf behind each door unless other components are specified
- Equipment racks hold 12RU and include a thermostatically controlled fan and plug strip



LAMINATE TOP WITH HARDWOOD EDGE

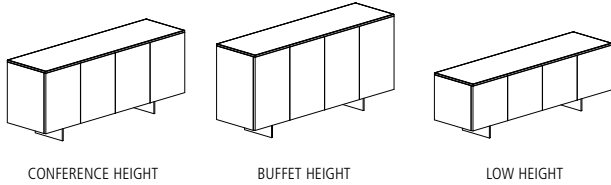

CASE MATERIAL KEY

V-BB Veneer Case with Blade Base

BLADE BASE

MODEL #	W x D x H	DESCRIPTION	-V-BB
CONFERENCE HEIGHT (24 IN. CASE WITH 6 IN. BLADE BASE)			
FWLC-3629-W-P	36 x 20 x 30	Two Doors	6,068
FWLC-5429-W-P	54 x 20 x 30	Three Doors	7,661
FWLC-7229-W-P	72 x 20 x 30	Four Doors	9,261
FWLC-9029-W-P	90 x 20 x 30	Five Doors	10,859
FWLD-3629-W-P	36 x 24 x 30	Two Doors	6,595
FWLD-5429-W-P	54 x 24 x 30	Three Doors	8,350
FWLD-7229-W-P	72 x 24 x 30	Four Doors	10,108
FWLD-9029-W-P	90 x 24 x 30	Five Doors	11,865
BUFFET HEIGHT (29 IN. CASE WITH 6 IN. BLADE BASE)			
FWCC-3636-W-P	36 x 20 x 35	Two Doors	6,491
FWCC-5436-W-P	54 x 20 x 35	Three Doors	8,212
FWCC-7236-W-P	72 x 20 x 35	Four Doors	9,942
FWCC-9036-W-P	90 x 20 x 35	Five Doors	11,665
FWCD-3636-W-P	36 x 24 x 35	Two Doors	7,062
FWCD-5436-W-P	54 x 24 x 35	Three Doors	8,954
FWCD-7236-W-P	72 x 24 x 35	Four Doors	10,855
FWCD-9036-W-P	90 x 24 x 35	Five Doors	12,755
LOW HEIGHT (18 IN. CASE WITH 6 IN. BLADE BASE)			
FWWC-3624-W-P	36 x 20 x 24	Two Doors	5,634
FWWC-5424-W-P	54 x 20 x 24	Three Doors	7,101
FWWC-7224-W-P	72 x 20 x 24	Four Doors	8,564
FWWC-9024-W-P	90 x 20 x 24	Five Doors	10,031

DOOR STYLE

DESCRIPTION	CODE	NOTES	PRICE
Vertical Veneer	-VD		No Charge
Horizontal Veneer	-HD		No Charge

PULL STYLE

DESCRIPTION	CODE	NOTES	TWO DOOR	THREE DOOR	FOUR DOOR	FIVE DOOR
Push Latch	No Code	Push to open (no pull). Applied to all doors.	No Charge	No Charge	No Charge	No Charge
Handle Pull - Powder Coat	-HP	Pull to open. Applied to all doors.	\$157	\$236	\$314	\$392
Handle Pull - High Polish Finish	-HP-HPF	Pull to open. Applied to all doors.	\$277	\$416	\$554	\$693
Handle Pull - Clear Anodized	-HP-CA	Pull to open. Applied to all doors.	\$157	\$236	\$314	\$392
Handle Pull - Goldmatt Anodized	-HP-GMA	Pull to open. Applied to all doors.	\$230	\$345	\$460	\$575
Handle Pull - Antique Brass Anodized	-HP-ABA	Pull to open. Applied to all doors.	\$230	\$345	\$460	\$575
Handle Pull - Light Bronze Anodized	-HP-LBA	Pull to open. Applied to all doors.	\$230	\$345	\$460	\$575



LAMINATE TOP WITH HARDWOOD EDGE

PUSH LATCH OR HANDLE PULL OPTIONS	CODE	PRICE	NOTES
Locks	Add -LK	\$315	Locks included in all cabinets
Polished Chrome Base	Add -PCBB	\$501	
Wire Frame Pull-Out Waste/Recycling Unit Conference and Buffet Height Credenzas (excludes 36" width)			
(1) 20" Depth Single Wire Frame Unit	Add -TF1	\$309	Located in the rightmost cabinet, behind the right door
(1) 24" Depth Double Wire Frame Unit	Add -TF2	\$477	Located in the rightmost cabinet, behind the right door
Dual Wire Frame Pull-Out Waste/Recycling Units Conference and Buffet Height Credenzas (Excludes 36"-54" width)			
(2) 20" Depth Single Wire Frame Units	Add -TF3	\$617	Located in the rightmost cabinet, behind left and right doors
(2) 24" Depth Double Wire Frame Units	Add -TF4	\$954	Located in the rightmost cabinet, behind left and right doors
24" Depth Equipment Rack Options Available on Buffet Height Credenzas			
Fixed Equipment Rack	Add -R2	\$947	Located in left most cabinet, behind left and right doors
Sliding Equipment Rack	Add -R1	\$3,467	Located in left most cabinet, behind left and right doors

ADDITIONAL HANDLE PULL OPTIONS

Wood Frame Pull-Out Waste/Recycling Bin Unit Conference and Buffet Height Credenzas (Excludes 36" width)			
(1) 20" Depth Single Wood Frame Unit	Add -FWTF1	\$817	Located in the rightmost cabinet, applied to right door
(1) 24" Depth Double Wood Frame Unit	Add -FWTF2	\$1,225	Located in the rightmost cabinet, applied to right door
Dual Wood Frame Pull-Out Waste/Recycling Bin Unit Conference and Buffet Height Credenzas (Excludes 36"-54" width)			
(2) 20" Depth Single Wood Frame Units	Add -FWTF3	\$1,633	Located in the rightmost cabinet, applied to left and right doors
(2) 24" Depth Double Wood Frame Units	Add -FWTF4	\$2,450	Located in the rightmost cabinet, applied to left and right doors
24" Depth Single Pull-Out Drawer Refrigerator Available on Conference and Buffet Height Credenzas			
Pull-Out Drawer Refrigerator	Add -FWOM24	\$7,327	Located in left most cabinet, includes applied door panel

EDGE PROFILE



Square Edge

REQUIRED INFORMATION (ORDER CANNOT BE ENTERED WITHOUT THIS INFORMATION)

See appendix pages vi-viii for surface material options.

- Choose Door Style: Defaults to case finish, if none selected
- Choose Pull Style: Defaults to Push Latch, if none selected
- Choose Metal Finish
- Choose Veneer Finish
- Choose Laminate

GENERAL INFORMATION

- Tops are 3/4"-thick with 3/16"-deep hardwood edge band
- When veneer case is specified, the case exterior is standard slip-match layup regardless of veneer door style selection
- Pull-Out Waste/Recycling Bin size: 17-7/8" x 8-3/32" x 11-9/16"; (1) 35 Qt.; Double Pull-Out Waste/Recycling Units include two bins
- When lock option is specified, color will default based on leg finish:
 - Aged Bronze, Black, Galaxy, Shadow, and Storm: Black
 - Cloud: White
 - Burnish, Foil, and Satin Bronze: Satin Nickel
 - Chrome: Polished Nickel
- Credenzas include one adjustable shelf behind each door unless other components are specified
- Equipment racks hold 12RU and include a thermostatically controlled fan and plug strip



LAMINATE TOP WITH SQUARE EDGE

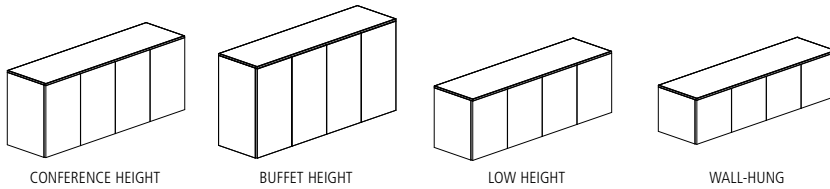

CASE MATERIAL KEY

PA Painted Case
PEC Laminate Case

CASE ONLY

MODEL #	W x D x H	DESCRIPTION	-PA	-PEC
CONFERENCE HEIGHT (29.5 INCH CASE)				
FWCC-3629-PE	36 x 20 x 29.5	Two Doors	5,441	4,912
FWCC-5429-PE	54 x 20 x 29.5	Three Doors	7,084	6,392
FWCC-7229-PE	72 x 20 x 29.5	Four Doors	8,727	7,877
FWCC-9029-PE	90 x 20 x 29.5	Five Doors	10,371	9,360
FWCD-3629-PE	36 x 24 x 29.5	Two Doors	5,986	5,401
FWCD-5429-PE	54 x 24 x 29.5	Three Doors	7,792	7,033
FWCD-7229-PE	72 x 24 x 29.5	Four Doors	9,600	8,664
FWCD-9029-PE	90 x 24 x 29.5	Five Doors	11,408	10,296
BUFFET HEIGHT (36.5 INCH CASE)				
FWBC-3636-PE	36 x 20 x 36.5	Two Doors	6,256	5,646
FWBC-5436-PE	54 x 20 x 36.5	Three Doors	8,144	7,350
FWBC-7236-PE	72 x 20 x 36.5	Four Doors	10,035	9,056
FWBC-9036-PE	90 x 20 x 36.5	Five Doors	11,924	10,762
FWBD-3636-PE	36 x 24 x 36.5	Two Doors	6,886	6,214
FWBD-5436-PE	54 x 24 x 36.5	Three Doors	8,959	8,087
FWBD-7236-PE	72 x 24 x 36.5	Four Doors	11,038	9,962
FWBD-9036-PE	90 x 24 x 36.5	Five Doors	13,114	11,837
LOW HEIGHT (24.5 INCH CASE)				
FWLC-3624-PE	36 x 20 x 24.5	Two Doors	5,038	4,548
FWLC-5424-PE	54 x 20 x 24.5	Three Doors	6,558	5,919
FWLC-7224-PE	72 x 20 x 24.5	Four Doors	8,079	7,293
FWLC-9024-PE	90 x 20 x 24.5	Five Doors	9,601	8,665
FWLD-3624-PE	36 x 24 x 24.5	Two Doors	5,543	5,004
FWLD-5424-PE	54 x 24 x 24.5	Three Doors	7,216	6,512
FWLD-7224-PE	72 x 24 x 24.5	Four Doors	8,890	8,023
FWLD-9024-PE	90 x 24 x 24.5	Five Doors	10,562	9,534
WALL-HUNG (18 INCH CASE)				
FWWC-3618-PE	36 x 20 x 18	Two Doors	4,630	4,175
FWWC-5418-PE	54 x 20 x 18	Three Doors	6,026	5,439
FWWC-7218-PE	72 x 20 x 18	Four Doors	7,418	6,696
FWWC-9018-PE	90 x 20 x 18	Five Doors	8,817	7,957

DOOR STYLE

DESCRIPTION	CODE	NOTES	PRICE
Laminate	-PED	Woodgrain laminate will be vertical on door	No Charge
Painted	-PAD		No Charge

PULL STYLE

DESCRIPTION	CODE	NOTES	TWO DOOR	THREE DOOR	FOUR DOOR	FIVE DOOR
Push Latch	No Code	Push to open (no pull). Applied to all doors.	No Charge	No Charge	No Charge	No Charge
Handle Pull - Powder Coat	-HP	Pull to open. Applied to all doors.	\$157	\$236	\$314	\$392
Handle Pull - High Polish Finish	-HP-HPF	Pull to open. Applied to all doors.	\$277	\$416	\$554	\$693
Handle Pull - Clear Anodized	-HP-CA	Pull to open. Applied to all doors.	\$157	\$236	\$314	\$392
Handle Pull - Goldmatt Anodized	-HP-GMA	Pull to open. Applied to all doors.	\$230	\$345	\$460	\$575
Handle Pull - Antique Brass Anodized	-HP-ABA	Pull to open. Applied to all doors.	\$230	\$345	\$460	\$575
Handle Pull - Light Bronze Anodized	-HP-LBA	Pull to open. Applied to all doors.	\$230	\$345	\$460	\$575



LAMINATE TOP WITH SQUARE EDGE

PUSH LATCH OR HANDLE PULL OPTIONS	CODE	PRICE	NOTES
Locks	Add -LK	\$315	Locks included in all cabinets
Drawers Behind Doors	Add -D	\$614	Available on Buffet Height Credenza
Wire Frame Pull-Out Waste/Recycling Unit Conference, Buffet, and Low Height Credenzas (excludes 36" width)			
(1) 20" Depth Single Wire Frame Unit	Add -TF1	\$309	Located in the rightmost cabinet, behind the right door
(1) 24" Depth Double Wire Frame Unit	Add -TF2	\$477	Located in the rightmost cabinet, behind the right door
Dual Wire Frame Pull-Out Waste/Recycling Units Conference, Buffet, and Low Height Credenzas (Excludes 36"-54" width)			
(2) 20" Depth Single Wire Frame Units	Add -TF3	\$617	Located in the rightmost cabinet, behind left and right doors
(2) 24" Depth Double Wire Frame Units	Add -TF4	\$954	Located in the rightmost cabinet, behind left and right doors
24" Depth Equipment Rack Options Available on Conference and Buffet Height Credenzas			
Fixed Equipment Rack	Add -R2	\$947	Located in left most cabinet, behind left and right doors
Sliding Equipment Rack	Add -R1	\$3,467	Located in left most cabinet, behind left and right doors

ADDITIONAL HANDLE PULL OPTIONS

Wood Frame Pull-Out Waste/Recycling Bin Unit Conference, Buffet, and Low Height Credenzas (Excludes 36" width)			
(1) 20" Depth Single Wood Frame Unit	Add -FWTF1	\$817	Located in the rightmost cabinet, applied to right door
(1) 24" Depth Double Wood Frame Unit	Add -FWTF2	\$1,225	Located in the rightmost cabinet, applied to right door
Dual Wood Frame Pull-Out Waste/Recycling Bin Unit Conference, Buffet, and Low Height Credenzas (Excludes 36"-54" width)			
(2) 20" Depth Single Wood Frame Units	Add -FWTF3	\$1,633	Located in the rightmost cabinet, applied to left and right doors
(2) 24" Depth Double Wood Frame Units	Add -FWTF4	\$2,450	Located in the rightmost cabinet, applied to left and right doors
24" Depth Single Pull-Out Drawer Refrigerator Available on Conference and Low Height Credenzas			
Pull-Out Drawer Refrigerator	Add -FWOM24	\$7,327	Located in left most cabinet, includes applied door panel

EDGE PROFILE



Square Edge

REQUIRED INFORMATION (ORDER CANNOT BE ENTERED WITHOUT THIS INFORMATION)

See appendix pages vi-viii for surface material options.

- Choose Door Style: Defaults to case finish, if none selected
- Choose Pull Style: Defaults to Push Latch, if none selected
- Choose Paint Finish, if specified
- Choose Laminate
- Choose Edge Color: Defaults to coordinating edge band

GENERAL INFORMATION

- Laminate Top with edge
 - Tops are 3/4"-thick with a 2 mm edge
 - Solid and patterned laminates default to suggested solid color edge band
 - Wood grain laminates default to coordinating woodgrain edge band
- When veneer case is specified, the case exterior is standard slip-match layup regardless of veneer door style selection
- Pull-Out Waste/Recycling Bin Size: 17-7/8" x 8-3/32" x 11-9/16"; (1) 35 Qt.; Double Pull-Out Waste/Recycling Units include two bins
- Locks
 - Painted (Case Only) - When lock option is specified, color will default based on Paint finish:
 - Aged Bronze, Black, Galaxy, Shadow, and Storm: Black
 - Cloud: White
 - Burnish, Foil, Satin Bronze: Satin Nickel
 - Chrome: Polished Nickel
 - Woodgrain Laminate (Case Only) - When lock option is specified, color will default to Satin Nickel
 - Solid Laminate (Case Only) - When lock option is specified, color will default based on Laminate finish:
 - Brite White, Dover White, Pearl: White
 - Graystone, Folkstone: Satin Nickel
 - Graphite: Black
- Credenzas include one adjustable shelf behind each door unless other components are specified
- Equipment racks hold 12RU and include a thermostatically controlled fan and plug strip



LAMINATE TOP WITH SQUARE EDGE

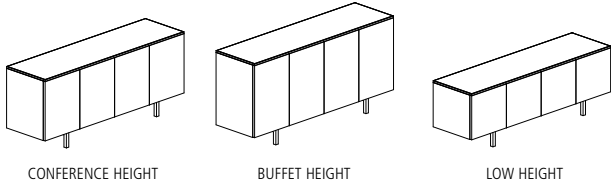

CASE MATERIAL KEY

PA-IB Painted Case with Inset Leg
 PEC-IB Laminate Case with Inset Leg

INSET LEG

MODEL #	W x D x H	DESCRIPTION	-PA-IB	-PEC-IB
CONFERENCE HEIGHT (24 IN. CASE WITH 6.5 IN. INSET LEG)				
FWLC-3629-PE	36 x 20 x 30.5	Two Doors	5,508	4,969
FWLC-5429-PE	54 x 20 x 30.5	Three Doors	7,026	6,342
FWLC-7229-PE	72 x 20 x 30.5	Four Doors	8,548	7,713
FWLC-9029-PE	90 x 20 x 30.5	Five Doors	10,067	9,086
FWLD-3629-PE	36 x 24 x 30.5	Two Doors	6,009	5,422
FWLD-5429-PE	54 x 24 x 30.5	Three Doors	7,681	6,934
FWLD-7229-PE	72 x 24 x 30.5	Four Doors	9,356	8,444
FWLD-9029-PE	90 x 24 x 30.5	Five Doors	11,026	9,954
BUFFET HEIGHT (29 IN. CASE WITH 6.5 IN. INSET LEG)				
FWCC-3636-PE	36 x 20 x 35.5	Two Doors	5,910	5,333
FWCC-5436-PE	54 x 20 x 35.5	Three Doors	7,549	6,811
FWCC-7236-PE	72 x 20 x 35.5	Four Doors	9,191	8,297
FWCC-9036-PE	90 x 20 x 35.5	Five Doors	10,835	9,778
FWCD-3636-PE	36 x 24 x 35.5	Two Doors	6,453	5,823
FWCD-5436-PE	54 x 24 x 35.5	Three Doors	8,258	7,453
FWCD-7236-PE	72 x 24 x 35.5	Four Doors	10,065	9,084
FWCD-9036-PE	90 x 24 x 35.5	Five Doors	11,873	10,715
LOW HEIGHT (18 IN. CASE WITH 6.5 IN. INSET LEG)				
FWWC-3624-PE	36 x 20 x 24.5	Two Doors	5,091	4,596
FWWC-5424-PE	54 x 20 x 24.5	Three Doors	6,491	5,858
FWWC-7224-PE	72 x 20 x 24.5	Four Doors	7,884	7,114
FWWC-9024-PE	90 x 20 x 24.5	Five Doors	9,281	8,374

DOOR STYLE

DESCRIPTION	CODE	NOTES	PRICE
Laminate	-PED	Woodgrain laminate will be vertical on door	No Charge
Painted	-PAD		No Charge

PULL STYLE

DESCRIPTION	CODE	NOTES	TWO DOOR	THREE DOOR	FOUR DOOR	FIVE DOOR
Push Latch	No Code	Push to open (no pull). Applied to all doors.	No Charge	No Charge	No Charge	No Charge
Handle Pull - Powder Coat	-HP	Pull to open. Applied to all doors.	\$157	\$236	\$314	\$392
Handle Pull - High Polish Finish	-HP-HPF	Pull to open. Applied to all doors.	\$277	\$416	\$554	\$693
Handle Pull - Clear Anodized	-HP-CA	Pull to open. Applied to all doors.	\$157	\$236	\$314	\$392
Handle Pull - Goldmatt Anodized	-HP-GMA	Pull to open. Applied to all doors.	\$230	\$345	\$460	\$575
Handle Pull - Antique Brass Anodized	-HP-ABA	Pull to open. Applied to all doors.	\$230	\$345	\$460	\$575
Handle Pull - Light Bronze Anodized	-HP-LBA	Pull to open. Applied to all doors.	\$230	\$345	\$460	\$575



LAMINATE TOP WITH SQUARE EDGE

PUSH LATCH OR HANDLE PULL OPTIONS	CODE	PRICE	NOTES
Locks	Add -LK	\$315	Locks included in all cabinets
Polished Chrome Base	Add -PCIB	\$501	
Wire Frame Pull-Out Waste/Recycling Unit Conference and Buffet Height Credenzas (excludes 36" width)			
(1) 20" Depth Single Wire Frame Unit	Add -TF1	\$309	Located in the rightmost cabinet, behind the right door
(1) 24" Depth Double Wire Frame Unit	Add -TF2	\$477	Located in the rightmost cabinet, behind the right door
Dual Wire Frame Pull-Out Waste/Recycling Units Conference and Buffet Height Credenzas (Excludes 36"-54" width)			
(2) 20" Depth Single Wire Frame Units	Add -TF3	\$617	Located in the rightmost cabinet, behind left and right doors
(2) 24" Depth Double Wire Frame Units	Add -TF4	\$954	Located in the rightmost cabinet, behind left and right doors
24" Depth Equipment Rack Options Available on Buffet Height Credenzas			
Fixed Equipment Rack	Add -R2	\$947	Located in left most cabinet, behind left and right doors
Sliding Equipment Rack	Add -R1	\$3,467	Located in left most cabinet, behind left and right doors

ADDITIONAL HANDLE PULL OPTIONS

Wood Frame Pull-Out Waste/Recycling Bin Unit Conference and Buffet Height Credenzas (Excludes 36" width)			
(1) 20" Depth Single Wood Frame Unit	Add -FWTF1	\$817	Located in the rightmost cabinet, applied to right door
(1) 24" Depth Double Wood Frame Unit	Add -FWTF2	\$1,225	Located in the rightmost cabinet, applied to right door
Dual Wood Frame Pull-Out Waste/Recycling Bin Unit Conference and Buffet Height Credenzas (Excludes 36"-54" width)			
(2) 20" Depth Single Wood Frame Units	Add -FWTF3	\$1,633	Located in the rightmost cabinet, applied to left and right doors
(2) 24" Depth Double Wood Frame Units	Add -FWTF4	\$2,450	Located in the rightmost cabinet, applied to left and right doors
24" Depth Single Pull-Out Drawer Refrigerator Available on Conference and Buffet Height Credenzas			
Pull-Out Drawer Refrigerator	Add -FWOM24	\$7,327	Located in left most cabinet, includes applied door panel

EDGE PROFILE



Square Edge

REQUIRED INFORMATION (ORDER CANNOT BE ENTERED WITHOUT THIS INFORMATION)

See appendix pages vi-viii for surface material options.

- Choose Door Style: Defaults to case finish, if none selected
- Choose Pull Style: Defaults to Push Latch, if none selected
- Choose Metal Finish
- Choose Paint Finish, if specified
- Choose Laminate
- Choose Edge Color: Defaults to coordinating edge band

GENERAL INFORMATION

- Laminate Top with edge
 - Tops are 3/4"-thick with a 2 mm edge
 - Solid and patterned laminates default to suggested solid color edge band
 - Wood grain laminates default to coordinating woodgrain edge band
- When veneer case is specified, the case exterior is standard slip-match layout regardless of veneer door style selection
- Pull-Out Waste/Recycling Bin size: 17-7/8" x 8-3/32" x 11-9/16"; (1) 35 Qt.; Double Pull-Out Waste/Recycling Units include two bins
- When lock option is specified, color will default based on leg finish:
 - Aged Bronze, Black, Galaxy, Shadow, and Storm: Black
 - Cloud: White
 - Burnish, Foil, and Satin Bronze: Satin Nickel
 - Chrome: Polished Nickel
- Credenzas include one adjustable shelf behind each door unless other components are specified
- Equipment racks hold 12RU and include a thermostatically controlled fan and plug strip



LAMINATE TOP WITH SQUARE EDGE

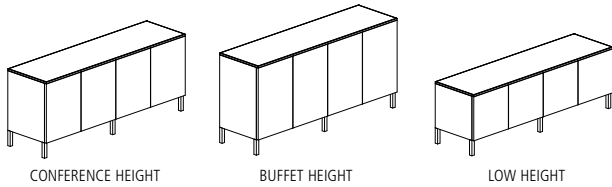

CASE MATERIAL KEY

PA-OB Painted Case with Edge-mount Post Leg
 PEC-OB Laminate Case with Edge-mount Post Leg

EDGE-MOUNT POST LEG

MODEL #	W x D x H	DESCRIPTION	-PA-OB	-PEC-OB
CONFERENCE HEIGHT (24 IN. CASE WITH 6.5 IN. EDGE-MOUNT POST LEG)				
FWLC-3629-PE	36 x 20 x 30.5	Two Door	5,508	4,969
FWLC-5429-PE	54 x 20 x 30.5	Three Door	7,026	6,342
FWLC-7229-PE	72 x 20 x 30.5	Four Door	8,548	7,713
FWLC-9029-PE	90 x 20 x 30.5	Five Door	10,067	9,086
FWLD-3629-PE	36 x 24 x 30.5	Two Door	6,009	5,422
FWLD-5429-PE	54 x 24 x 30.5	Three Door	7,681	6,934
FWLD-7229-PE	72 x 24 x 30.5	Four Door	9,356	8,444
FWLD-9029-PE	90 x 24 x 30.5	Five Door	11,026	9,954
BUFFET HEIGHT (29 IN. CASE WITH 6.5 IN. EDGE-MOUNT POST LEG)				
FWCC-3636-PE	36 x 20 x 35.5	Two Door	5,910	5,333
FWCC-5436-PE	54 x 20 x 35.5	Three Door	7,549	6,811
FWCC-7236-PE	72 x 20 x 35.5	Four Door	9,191	8,297
FWCC-9036-PE	90 x 20 x 35.5	Five Door	10,835	9,778
FWCD-3636-PE	36 x 24 x 35.5	Two Door	6,453	5,823
FWCD-5436-PE	54 x 24 x 35.5	Three Door	8,258	7,453
FWCD-7236-PE	72 x 24 x 35.5	Four Door	10,065	9,084
FWCD-9036-PE	90 x 24 x 35.5	Five Door	11,873	10,715
LOW HEIGHT (18 IN. CASE WITH 6.5 IN. EDGE-MOUNT POST LEG)				
FWWC-3624-PE	36 x 20 x 24.5	Two Door	5,091	4,596
FWWC-5424-PE	54 x 20 x 24.5	Three Door	6,491	5,858
FWWC-7224-PE	72 x 20 x 24.5	Four Door	7,884	7,114
FWWC-9024-PE	90 x 20 x 24.5	Five Door	9,281	8,374

DOOR STYLE

DESCRIPTION	CODE	NOTES	PRICE
Laminate	-PED	Woodgrain laminate will be vertical on door	No Charge
Painted	-PAD		No Charge

PULL STYLE

DESCRIPTION	CODE	NOTES	TWO DOOR	THREE DOOR	FOUR DOOR	FIVE DOOR
Push Latch	No Code	Push to open (no pull). Applied to all doors.	No Charge	No Charge	No Charge	No Charge
Handle Pull - Powder Coat	-HP	Pull to open. Applied to all doors.	\$157	\$236	\$314	\$392
Handle Pull - High Polish Finish	-HP-HPF	Pull to open. Applied to all doors.	\$277	\$416	\$554	\$693
Handle Pull - Clear Anodized	-HP-CA	Pull to open. Applied to all doors.	\$157	\$236	\$314	\$392
Handle Pull - Goldmatt Anodized	-HP-GMA	Pull to open. Applied to all doors.	\$230	\$345	\$460	\$575
Handle Pull - Antique Brass Anodized	-HP-ABA	Pull to open. Applied to all doors.	\$230	\$345	\$460	\$575
Handle Pull - Light Bronze Anodized	-HP-LBA	Pull to open. Applied to all doors.	\$230	\$345	\$460	\$575



LAMINATE TOP WITH SQUARE EDGE

PUSH LATCH OR HANDLE PULL OPTIONS	CODE	PRICE	NOTES
Locks	Add -LK	\$315	Locks included in all cabinets
Polished Chrome Base	Add -PCOB	\$541	
Wire Frame Pull-Out Waste/Recycling Unit Conference and Buffet Height Credenzas (excludes 36" width)			
(1) 20" Depth Single Wire Frame Unit	Add -TF1	\$309	Located in the rightmost cabinet, behind the right door
(1) 24" Depth Double Wire Frame Unit	Add -TF2	\$477	Located in the rightmost cabinet, behind the right door
Dual Wire Frame Pull-Out Waste/Recycling Units Conference and Buffet Height Credenzas (Excludes 36"-54" width)			
(2) 20" Depth Single Wire Frame Units	Add -TF3	\$617	Located in the rightmost cabinet, behind left and right doors
(2) 24" Depth Double Wire Frame Units	Add -TF4	\$954	Located in the rightmost cabinet, behind left and right doors
24" Depth Equipment Rack Options Available on Buffet Height Credenzas			
Fixed Equipment Rack	Add -R2	\$947	Located in left most cabinet, behind left and right doors
Sliding Equipment Rack	Add -R1	\$3,467	Located in left most cabinet, behind left and right doors

ADDITIONAL HANDLE PULL OPTIONS

Wood Frame Pull-Out Waste/Recycling Bin Unit Conference and Buffet Height Credenzas (Excludes 36" width)			
(1) 20" Depth Single Wood Frame Unit	Add -FWTF1	\$817	Located in the rightmost cabinet, applied to right door
(1) 24" Depth Double Wood Frame Unit	Add -FWTF2	\$1,225	Located in the rightmost cabinet, applied to right door
Dual Wood Frame Pull-Out Waste/Recycling Bin Unit Conference and Buffet Height Credenzas (Excludes 36"-54" width)			
(2) 20" Depth Single Wood Frame Units	Add -FWTF3	\$1,633	Located in the rightmost cabinet, applied to left and right doors
(2) 24" Depth Double Wood Frame Units	Add -FWTF4	\$2,450	Located in the rightmost cabinet, applied to left and right doors
24" Depth Single Pull-Out Drawer Refrigerator Available on Conference and Buffet Height Credenzas			
Pull-Out Drawer Refrigerator	Add -FWOM24	\$7,327	Located in left most cabinet, includes applied door panel

EDGE PROFILE



Square Edge

REQUIRED INFORMATION (ORDER CANNOT BE ENTERED WITHOUT THIS INFORMATION)

See appendix pages vi-viii for surface material options.

- Choose Door Style: Defaults to case finish, if none selected
- Choose Pull Style: Defaults to Push Latch, if none selected
- Choose Metal Finish
- Choose Paint Finish, if specified
- Choose Laminate
- Choose Edge Color: Defaults to coordinating edge band

GENERAL INFORMATION

- Laminate Top with edge
 - Tops are 3/4"-thick with a 2 mm edge
 - Solid and patterned laminates default to suggested solid color edge band
 - Wood grain laminates default to coordinating woodgrain edge band
- When veneer case is specified, the case exterior is standard slip-match layout regardless of veneer door style selection
- Pull-Out Waste/Recycling Bin size: 17-7/8" x 8-3/32" x 11-9/16"; (1) 35 Qt.; Double Pull-Out Waste/Recycling Units include two bins
- When lock option is specified, color will default based on leg finish:
 - Aged Bronze, Black, Galaxy, Shadow, and Storm: Black
 - Cloud: White
 - Burnish, Foil, and Satin Bronze: Satin Nickel
 - Chrome: Polished Nickel
- Credenzas include one adjustable shelf behind each door unless other components are specified
- Equipment racks hold 12RU and include a thermostatically controlled fan and plug strip



LAMINATE TOP WITH SQUARE EDGE

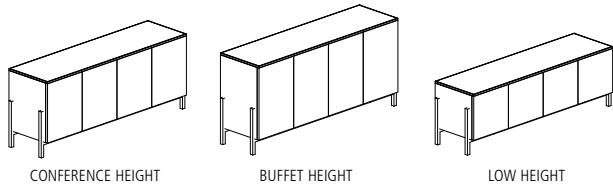

CASE MATERIAL KEY

PA-CB Painted Case with Cradle Base
 PEC-CB Laminate Case with Cradle Base

CRADLE BASE

MODEL #	W x D x H	DESCRIPTION	-PA-CB	-PEC-CB
CONFERENCE HEIGHT (24 IN. CASE WITH 6.5 IN. CRADLE BASE)				
FWLC-3629-PE	36 x 20 x 30.5	Two Doors	6,126	5,530
FWLC-5429-PE	54 x 20 x 30.5	Three Doors	7,645	6,900
FWLC-7229-PE	72 x 20 x 30.5	Four Doors	9,167	8,273
FWLC-9029-PE	90 x 20 x 30.5	Five Doors	10,689	9,646
FWLD-3629-PE	36 x 24 x 30.5	Two Doors	6,629	5,981
FWLD-5429-PE	54 x 24 x 30.5	Three Doors	8,301	7,493
FWLD-7229-PE	72 x 24 x 30.5	Four Doors	9,977	9,004
FWLD-9029-PE	90 x 24 x 30.5	Five Doors	11,648	10,513
BUFFET HEIGHT (29 IN. CASE WITH 6.5 IN. CRADLE BASE)				
FWCC-3636-PE	36 x 20 x 35.5	Two Doors	6,529	5,892
FWCC-5436-PE	54 x 20 x 35.5	Three Doors	8,168	7,373
FWCC-7236-PE	72 x 20 x 35.5	Four Doors	9,813	8,855
FWCC-9036-PE	90 x 20 x 35.5	Five Doors	11,454	10,338
FWCD-3636-PE	36 x 24 x 35.5	Two Doors	7,072	6,382
FWCD-5436-PE	54 x 24 x 35.5	Three Doors	8,876	8,010
FWCD-7236-PE	72 x 24 x 35.5	Four Doors	10,686	9,641
FWCD-9036-PE	90 x 24 x 35.5	Five Doors	12,492	11,273
LOW HEIGHT (18 IN. CASE WITH 6.5 IN. CRADLE BASE)				
FWWC-3624-PE	36 x 20 x 24.5	Two Doors	5,711	5,154
FWWC-5424-PE	54 x 20 x 24.5	Three Doors	7,109	6,419
FWWC-7224-PE	72 x 20 x 24.5	Four Doors	8,504	7,676
FWWC-9024-PE	90 x 20 x 24.5	Five Doors	9,900	8,934

DOOR STYLE

DESCRIPTION	CODE	NOTES	PRICE
Laminate	-PED	Woodgrain laminate will be vertical on door	No Charge
Painted	-PAD		No Charge

PULL STYLE

DESCRIPTION	CODE	NOTES	TWO DOOR	THREE DOOR	FOUR DOOR	FIVE DOOR
Push Latch	No Code	Push to open (no pull). Applied to all doors.	No Charge	No Charge	No Charge	No Charge
Handle Pull - Powder Coat	-HP	Pull to open. Applied to all doors.	\$157	\$236	\$314	\$392
Handle Pull - High Polish Finish	-HP-HPF	Pull to open. Applied to all doors.	\$277	\$416	\$554	\$693
Handle Pull - Clear Anodized	-HP-CA	Pull to open. Applied to all doors.	\$157	\$236	\$314	\$392
Handle Pull - Goldmatt Anodized	-HP-GMA	Pull to open. Applied to all doors.	\$230	\$345	\$460	\$575
Handle Pull - Antique Brass Anodized	-HP-ABA	Pull to open. Applied to all doors.	\$230	\$345	\$460	\$575
Handle Pull - Light Bronze Anodized	-HP-LBA	Pull to open. Applied to all doors.	\$230	\$345	\$460	\$575



LAMINATE TOP WITH SQUARE EDGE

PUSH LATCH OR HANDLE PULL OPTIONS	CODE	PRICE	NOTES
Locks Polished Chrome Base	Add -LK Add -PCCB	\$315 \$1,775	Locks included in all cabinets
Wire Frame Pull-Out Waste/Recycling Unit Conference and Buffet Height Credenzas (excludes 36" width)			
(1) 20" Depth Single Wire Frame Unit	Add -TF1	\$309	Located in the rightmost cabinet, behind the right door
(1) 24" Depth Double Wire Frame Unit	Add -TF2	\$477	Located in the rightmost cabinet, behind the right door
Dual Wire Frame Pull-Out Waste/Recycling Units Conference and Buffet Height Credenzas (Excludes 36"-54" width)			
(2) 20" Depth Single Wire Frame Units	Add -TF3	\$617	Located in the rightmost cabinet, behind left and right doors
(2) 24" Depth Double Wire Frame Units	Add -TF4	\$954	Located in the rightmost cabinet, behind left and right doors
24" Depth Equipment Rack Options Available on Buffet Height Credenzas			
Fixed Equipment Rack	Add -R2	\$947	Located in left most cabinet, behind left and right doors
Sliding Equipment Rack	Add -R1	\$3,467	Located in left most cabinet, behind left and right doors

ADDITIONAL HANDLE PULL OPTIONS

Wood Frame Pull-Out Waste/Recycling Bin Unit Conference and Buffet Height Credenzas (Excludes 36" width)			
(1) 20" Depth Single Wood Frame Unit	Add -FWTF1	\$817	Located in the rightmost cabinet, applied to right door
(1) 24" Depth Double Wood Frame Unit	Add -FWTF2	\$1,225	Located in the rightmost cabinet, applied to right door
Dual Wood Frame Pull-Out Waste/Recycling Bin Unit Conference and Buffet Height Credenzas (Excludes 36"-54" width)			
(2) 20" Depth Single Wood Frame Units	Add -FWTF3	\$1,633	Located in the rightmost cabinet, applied to left and right doors
(2) 24" Depth Double Wood Frame Units	Add -FWTF4	\$2,450	Located in the rightmost cabinet, applied to left and right doors
24" Depth Single Pull-Out Drawer Refrigerator Available on Conference and Buffet Height Credenzas			
Pull-Out Drawer Refrigerator	Add -FWOM24	\$7,327	Located in left most cabinet, includes applied door panel

EDGE PROFILE



Square Edge

REQUIRED INFORMATION (ORDER CANNOT BE ENTERED WITHOUT THIS INFORMATION)

See appendix pages vi-viii for surface material options.

- Choose Door Style: Defaults to case finish, if none selected
- Choose Pull Style: Defaults to Push Latch, if none selected
- Choose Metal Finish
- Choose Paint Finish, if specified
- Choose Laminate
- Choose Edge Color: Defaults to coordinating edge band

GENERAL INFORMATION

- Laminate Top with edge
 - Tops are 3/4"-thick with a 2 mm edge
 - Solid and patterned laminates default to suggested solid color edge band
 - Wood grain laminates default to coordinating woodgrain edge band
- When veneer case is specified, the case exterior is standard slip-match layout regardless of veneer door style selection
- Pull-Out Waste/Recycling Bin size: 17-7/8" x 8-3/32" x 11-9/16"; (1) 35 Qt.; Double Pull-Out Waste/Recycling Units include two bins
- When lock option is specified, color will default based on leg finish:
 - Aged Bronze, Black, Galaxy, Shadow, and Storm: Black
 - Cloud: White
 - Burnish, Foil, and Satin Bronze: Satin Nickel
 - Chrome: Polished Nickel
- Credenzas include one adjustable shelf behind each door unless other components are specified
- Equipment racks hold 12RU and include a thermostatically controlled fan and plug strip



LAMINATE TOP WITH SQUARE EDGE

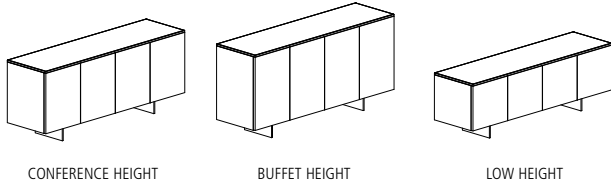

CASE MATERIAL KEY

PA-BB Painted Case with Blade Base
 PEC-BB Laminate Case with Blade Base

BLADE BASE

MODEL #	W x D x H	DESCRIPTION	-PA-BB	-PEC-BB
CONFERENCE HEIGHT (24 IN. CASE WITH 6 IN. BLADE BASE)				
FWLC-3629-PE	36 x 20 x 30	Two Doors	5,815	5,250
FWLC-5429-PE	54 x 20 x 30	Three Doors	7,333	6,620
FWLC-7229-PE	72 x 20 x 30	Four Doors	8,856	7,995
FWLC-9029-PE	90 x 20 x 30	Five Doors	10,379	9,367
FWLD-3629-PE	36 x 24 x 30	Two Doors	6,320	5,701
FWLD-5429-PE	54 x 24 x 30	Three Doors	7,992	7,212
FWLD-7229-PE	72 x 24 x 30	Four Doors	9,666	8,722
FWLD-9029-PE	90 x 24 x 30	Five Doors	11,339	10,232
BUFFET HEIGHT (29 IN. CASE WITH 6 IN. BLADE BASE)				
FWCC-3636-PE	36 x 20 x 35	Two Doors	6,217	5,613
FWCC-5436-PE	54 x 20 x 35	Three Doors	7,859	7,090
FWCC-7236-PE	72 x 20 x 35	Four Doors	9,501	8,576
FWCC-9036-PE	90 x 20 x 35	Five Doors	11,144	10,058
FWCD-3636-PE	36 x 24 x 35	Two Doors	6,761	6,102
FWCD-5436-PE	54 x 24 x 35	Three Doors	8,569	7,732
FWCD-7236-PE	72 x 24 x 35	Four Doors	10,376	9,363
FWCD-9036-PE	90 x 24 x 35	Five Doors	12,182	10,993
LOW HEIGHT (18 IN. CASE WITH 6 IN. BLADE BASE)				
FWWC-3624-PE	36 x 20 x 24	Two Doors	5,401	4,876
FWWC-5424-PE	54 x 20 x 24	Three Doors	6,800	6,136
FWWC-7224-PE	72 x 20 x 24	Four Doors	8,195	7,398
FWWC-9024-PE	90 x 20 x 24	Five Doors	9,588	8,654

DOOR STYLE

DESCRIPTION	CODE	NOTES	PRICE
Laminate	-PED	Woodgrain laminate will be vertical on door	No Charge
Painted	-PAD		No Charge

PULL STYLE

DESCRIPTION	CODE	NOTES	TWO DOOR	THREE DOOR	FOUR DOOR	FIVE DOOR
Push Latch	No Code	Push to open (no pull). Applied to all doors.	No Charge	No Charge	No Charge	No Charge
Handle Pull - Powder Coat	-HP	Pull to open. Applied to all doors.	\$157	\$236	\$314	\$392
Handle Pull - High Polish Finish	-HP-HPF	Pull to open. Applied to all doors.	\$277	\$416	\$554	\$693
Handle Pull - Clear Anodized	-HP-CA	Pull to open. Applied to all doors.	\$157	\$236	\$314	\$392
Handle Pull - Goldmatt Anodized	-HP-GMA	Pull to open. Applied to all doors.	\$230	\$345	\$460	\$575
Handle Pull - Antique Brass Anodized	-HP-ABA	Pull to open. Applied to all doors.	\$230	\$345	\$460	\$575
Handle Pull - Light Bronze Anodized	-HP-LBA	Pull to open. Applied to all doors.	\$230	\$345	\$460	\$575



LAMINATE TOP WITH SQUARE EDGE

PUSH LATCH OR HANDLE PULL OPTIONS	CODE	PRICE	NOTES
Locks Polished Chrome Base	Add -LK Add -PCBB	\$315 \$501	Locks included in all cabinets
Wire Frame Pull-Out Waste/Recycling Unit Conference and Buffet Height Credenzas (excludes 36" width)			
(1) 20" Depth Single Wire Frame Unit	Add -TF1	\$309	Located in the rightmost cabinet, behind the right door
(1) 24" Depth Double Wire Frame Unit	Add -TF2	\$477	Located in the rightmost cabinet, behind the right door
Dual Wire Frame Pull-Out Waste/Recycling Units Conference and Buffet Height Credenzas (Excludes 36"-54" width)			
(2) 20" Depth Single Wire Frame Units	Add -TF3	\$617	Located in the rightmost cabinet, behind left and right doors
(2) 24" Depth Double Wire Frame Units	Add -TF4	\$954	Located in the rightmost cabinet, behind left and right doors
24" Depth Equipment Rack Options Available on Buffet Height Credenzas			
Fixed Equipment Rack	Add -R2	\$947	Located in left most cabinet, behind left and right doors
Sliding Equipment Rack	Add -R1	\$3,467	Located in left most cabinet, behind left and right doors

ADDITIONAL HANDLE PULL OPTIONS

Wood Frame Pull-Out Waste/Recycling Bin Unit Conference and Buffet Height Credenzas (Excludes 36" width)			
(1) 20" Depth Single Wood Frame Unit	Add -FWTF1	\$817	Located in the rightmost cabinet, applied to right door
(1) 24" Depth Double Wood Frame Unit	Add -FWTF2	\$1,225	Located in the rightmost cabinet, applied to right door
Dual Wood Frame Pull-Out Waste/Recycling Bin Unit Conference and Buffet Height Credenzas (Excludes 36"-54" width)			
(2) 20" Depth Single Wood Frame Units	Add -FWTF3	\$1,633	Located in the rightmost cabinet, applied to left and right doors
(2) 24" Depth Double Wood Frame Units	Add -FWTF4	\$2,450	Located in the rightmost cabinet, applied to left and right doors
24" Depth Single Pull-Out Drawer Refrigerator Available on Conference and Buffet Height Credenzas			
Pull-Out Drawer Refrigerator	Add -FWOM24	\$7,327	Located in left most cabinet, includes applied door panel

EDGE PROFILE

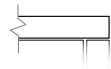

Square Edge

REQUIRED INFORMATION (ORDER CANNOT BE ENTERED WITHOUT THIS INFORMATION)

See appendix pages vi-viii for surface material options.

- Choose Door Style: Defaults to case finish, if none selected
- Choose Pull Style: Defaults to Push Latch, if none selected
- Choose Metal Finish
- Choose Paint Finish, if specified
- Choose Laminate
- Choose Edge Color: Defaults to coordinating edge band

GENERAL INFORMATION

- Laminate Top with edge
 - Tops are 3/4"-thick with a 2 mm edge
 - Solid and patterned laminates default to suggested solid color edge band
 - Wood grain laminates default to coordinating woodgrain edge band
- When veneer case is specified, the case exterior is standard slip-match layout regardless of veneer door style selection
- Pull-Out Waste/Recycling Bin size: 17-7/8" x 8-3/32" x 11-9/16"; (1) 35 Qt.; Double Pull-Out Waste/Recycling Units include two bins
- When lock option is specified, color will default based on leg finish:
 - Aged Bronze, Black, Galaxy, Shadow, and Storm: Black
 - Cloud: White
 - Burnish, Foil, and Satin Bronze: Satin Nickel
 - Chrome: Polished Nickel
- Credenzas include one adjustable shelf behind each door unless other components are specified
- Equipment racks hold 12RU and include a thermostatically controlled fan and plug strip



GLOSS GLASS TOP

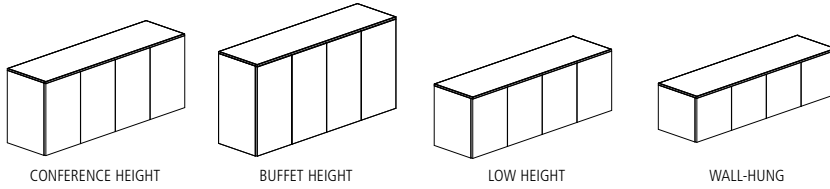

CASE MATERIAL KEY

PA Painted Case
V Veneer Case

CASE ONLY

MODEL #	W x D x H	DESCRIPTION	-PA	-V
CONFERENCE HEIGHT (29 INCH CASE)				
FWCC-3629-GG	36 x 20 x 29	Two Doors	6,257	6,953
FWCC-5429-GG	54 x 20 x 29	Three Doors	8,145	9,050
FWCC-7229-GG	72 x 20 x 29	Four Doors	10,036	11,149
FWCC-9029-GG	90 x 20 x 29	Five Doors	11,925	13,248
FWCD-3629-GG	36 x 24 x 29	Two Doors	6,886	7,646
FWCD-5429-GG	54 x 24 x 29	Three Doors	8,961	9,954
FWCD-7229-GG	72 x 24 x 29	Four Doors	11,039	12,264
FWCD-9029-GG	90 x 24 x 29	Five Doors	13,117	14,571
BUFFET HEIGHT (36 INCH CASE)				
FWBC-3636-GG	36 x 20 x 36	Two Doors	7,195	7,992
FWBC-5436-GG	54 x 20 x 36	Three Doors	9,366	10,402
FWBC-7236-GG	72 x 20 x 36	Four Doors	11,540	12,816
FWBC-9036-GG	90 x 20 x 36	Five Doors	13,713	15,232
FWBD-3636-GG	36 x 24 x 36	Two Doors	7,914	8,791
FWBD-5436-GG	54 x 24 x 36	Three Doors	10,303	11,442
FWBD-7236-GG	72 x 24 x 36	Four Doors	12,692	14,098
FWBD-9036-GG	90 x 24 x 36	Five Doors	15,082	16,758
LOW HEIGHT (24 INCH CASE)				
FWLC-3624-GG	36 x 20 x 24	Two Doors	5,796	6,440
FWLC-5424-GG	54 x 20 x 24	Three Doors	7,540	8,382
FWLC-7224-GG	72 x 20 x 24	Four Doors	9,295	10,322
FWLC-9024-GG	90 x 20 x 24	Five Doors	11,043	12,269
FWLD-3624-GG	36 x 24 x 24	Two Doors	6,375	7,081
FWLD-5424-GG	54 x 24 x 24	Three Doors	8,299	9,218
FWLD-7224-GG	72 x 24 x 24	Four Doors	10,222	11,355
FWLD-9024-GG	90 x 24 x 24	Five Doors	12,145	13,492
WALL-HUNG (17.5 INCH CASE)				
FWWC-3618-GG	36 x 20 x 17.5	Two Doors	5,323	5,912
FWWC-5418-GG	54 x 20 x 17.5	Three Doors	6,928	7,692
FWWC-7218-GG	72 x 20 x 17.5	Four Doors	8,531	9,478
FWWC-9018-GG	90 x 20 x 17.5	Five Doors	10,138	11,264

DOOR STYLE

DESCRIPTION	CODE	NOTES	PRICE
Vertical Veneer	-VD		No Charge
Horizontal Veneer	-HD		No Charge
Veneer/Paint Combination	-VPD	Reference page 8 for predetermined accent door locations	No Charge
Painted	-PAD		No Charge

PULL STYLE

DESCRIPTION	CODE	NOTES	TWO DOOR	THREE DOOR	FOUR DOOR	FIVE DOOR
Push Latch	No Code	Push to open (no pull). Applied to all doors.	No Charge	No Charge	No Charge	No Charge
Handle Pull - Powder Coat	-HP	Pull to open. Applied to all doors.	\$157	\$236	\$314	\$392
Handle Pull - High Polish Finish	-HP-HPF	Pull to open. Applied to all doors.	\$277	\$416	\$554	\$693
Handle Pull - Clear Anodized	-HP-CA	Pull to open. Applied to all doors.	\$157	\$236	\$314	\$392
Handle Pull - Goldmatt Anodized	-HP-GMA	Pull to open. Applied to all doors.	\$230	\$345	\$460	\$575
Handle Pull - Antique Brass Anodized	-HP-ABA	Pull to open. Applied to all doors.	\$230	\$345	\$460	\$575
Handle Pull - Light Bronze Anodized	-HP-LBA	Pull to open. Applied to all doors.	\$230	\$345	\$460	\$575



GLOSS GLASS TOP

PUSH LATCH OR HANDLE PULL OPTIONS	CODE	PRICE	NOTES
Locks	Add -LK	\$315	Locks included in all cabinets
Drawers Behind Doors	Add -D	\$614	Available on Buffet Height Credenza
Wire Frame Pull-Out Waste/Recycling Unit Conference, Buffet, and Low Height Credenzas (excludes 36" width)			
(1) 20" Depth Single Wire Frame Unit	Add -TF1	\$309	Located in the rightmost cabinet, behind the right door
(1) 24" Depth Double Wire Frame Unit	Add -TF2	\$477	Located in the rightmost cabinet, behind the right door
Dual Wire Frame Pull-Out Waste/Recycling Units Conference, Buffet, and Low Height Credenzas (Excludes 36"-54" width)			
(2) 20" Depth Single Wire Frame Units	Add -TF3	\$617	Located in the rightmost cabinet, behind left and right doors
(2) 24" Depth Double Wire Frame Units	Add -TF4	\$954	Located in the rightmost cabinet, behind left and right doors
24" Depth Equipment Rack Options Available on Conference and Buffet Height Credenzas			
Fixed Equipment Rack	Add -R2	\$947	Located in left most cabinet, behind left and right doors
Sliding Equipment Rack	Add -R1	\$3,467	Located in left most cabinet, behind left and right doors

ADDITIONAL HANDLE PULL OPTIONS

Wood Frame Pull-Out Waste/Recycling Bin Unit Conference, Buffet, and Low Height Credenzas (Excludes 36" width)			
(1) 20" Depth Single Wood Frame Unit	Add -FWTF1	\$817	Located in the rightmost cabinet, applied to right door
(1) 24" Depth Double Wood Frame Unit	Add -FWTF2	\$1,225	Located in the rightmost cabinet, applied to right door
Dual Wood Frame Pull-Out Waste/Recycling Bin Unit Conference, Buffet, and Low Height Credenzas (Excludes 36"-54" width)			
(2) 20" Depth Single Wood Frame Units	Add -FWTF3	\$1,633	Located in the rightmost cabinet, applied to left and right doors
(2) 24" Depth Double Wood Frame Units	Add -FWTF4	\$2,450	Located in the rightmost cabinet, applied to left and right doors
24" Depth Single Pull-Out Drawer Refrigerator Available on Conference and Low Height Credenzas			
Pull-Out Drawer Refrigerator	Add -FWOM24	\$7,327	Located in left most cabinet, includes applied door panel

EDGE PROFILE



Glass Top Edge

REQUIRED INFORMATION (ORDER CANNOT BE ENTERED WITHOUT THIS INFORMATION)

See appendix pages vi-viii for surface material options.

- Choose Door Style: Defaults to case finish, if none selected
- Choose Pull Style: Defaults to Push Latch, if none selected
- Choose Glass Finish
- Choose Paint Finish, if specified
- Choose Veneer Finish, if specified

GENERAL INFORMATION

- Glass is 1/4" -thick back-painted, low-iron glass
- When veneer case is specified, the case exterior is standard slip-match layout regardless of veneer door style selection
- Pull-Out Waste/Recycling Bin size: 17-7/8" x 8-3/32" x 11-9/16"; (1) 35 Qt.; Double Pull-Out Waste/Recycling Units include two bins
- Locks
 - Veneer (Case Only) - When lock option is specified, color will default to Satin Nickel
 - Painted (Case Only) - When lock option is specified, color will default based on Paint finish:
 - Aged Bronze, Black, Galaxy, Shadow, and Storm: Black
 - Cloud: White
 - Burnish, Foil, Satin Bronze: Satin Nickel
 - Chrome: Polished Nickel
- Credenzas include one adjustable shelf behind each door unless other components are specified
- Equipment racks hold 12RU and include a thermostatically controlled fan and plug strip



GLOSS GLASS TOP

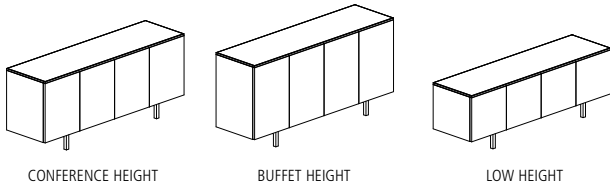

CASE MATERIAL KEY

PA-IB Painted Case with Inset Leg
 V-IB Veneer Case with Inset Leg

INSET LEG

MODEL #	W x D x H	DESCRIPTION	-PA-IB	-V-IB
CONFERENCE HEIGHT (23.5 IN. CASE WITH 6.5 IN. INSET LEG)				
FWLC-3629-GG	36 x 20 x 30	Two Doors	6,260	6,904
FWLC-5429-GG	54 x 20 x 30	Three Doors	8,007	8,847
FWLC-7229-GG	72 x 20 x 30	Four Doors	9,759	10,790
FWLC-9029-GG	90 x 20 x 30	Five Doors	11,509	12,734
FWLD-3629-GG	36 x 24 x 30	Two Doors	6,837	7,542
FWLD-5429-GG	54 x 24 x 30	Three Doors	8,763	9,683
FWLD-7229-GG	72 x 24 x 30	Four Doors	10,688	11,822
FWLD-9029-GG	90 x 24 x 30	Five Doors	12,611	13,955
BUFFET HEIGHT (28.5 IN. CASE WITH 6.5 IN. INSET LEG)				
FWCC-3636-GG	36 x 20 x 35	Two Doors	6,724	7,415
FWCC-5436-GG	54 x 20 x 35	Three Doors	8,611	9,517
FWCC-7236-GG	72 x 20 x 35	Four Doors	10,502	11,617
FWCC-9036-GG	90 x 20 x 35	Five Doors	12,389	13,713
FWCD-3636-GG	36 x 24 x 35	Two Doors	7,349	8,111
FWCD-5436-GG	54 x 24 x 35	Three Doors	9,426	10,417
FWCD-7236-GG	72 x 24 x 35	Four Doors	11,505	12,729
FWCD-9036-GG	90 x 24 x 35	Five Doors	13,583	15,037
LOW HEIGHT (17.5 IN. CASE WITH 6.5 IN. INSET LEG)				
FWWC-3624-GG	36 x 20 x 24	Two Doors	5,786	6,376
FWWC-5424-GG	54 x 20 x 24	Three Doors	7,393	8,159
FWWC-7224-GG	72 x 20 x 24	Four Doors	8,998	9,944
FWWC-9024-GG	90 x 20 x 24	Five Doors	10,603	11,729

DOOR STYLE

DESCRIPTION	CODE	NOTES	PRICE
Vertical Veneer	-VD		No Charge
Horizontal Veneer	-HD		No Charge
Veneer/Paint Combination	-VPD	Reference page 8 for predetermined accent door locations	No Charge
Painted	-PAD		No Charge

PULL STYLE

DESCRIPTION	CODE	NOTES	TWO DOOR	THREE DOOR	FOUR DOOR	FIVE DOOR
Push Latch	No Code	Push to open (no pull). Applied to all doors.	No Charge	No Charge	No Charge	No Charge
Handle Pull - Powder Coat	-HP	Pull to open. Applied to all doors.	\$157	\$236	\$314	\$392
Handle Pull - High Polish Finish	-HP-HPF	Pull to open. Applied to all doors.	\$277	\$416	\$554	\$693
Handle Pull - Clear Anodized	-HP-CA	Pull to open. Applied to all doors.	\$157	\$236	\$314	\$392
Handle Pull - Goldmatt Anodized	-HP-GMA	Pull to open. Applied to all doors.	\$230	\$345	\$460	\$575
Handle Pull - Antique Brass Anodized	-HP-ABA	Pull to open. Applied to all doors.	\$230	\$345	\$460	\$575
Handle Pull - Light Bronze Anodized	-HP-LBA	Pull to open. Applied to all doors.	\$230	\$345	\$460	\$575



GLOSS GLASS TOP

PUSH LATCH OR HANDLE PULL OPTIONS	CODE	PRICE	NOTES
Locks	Add -LK	\$315	Locks included in all cabinets
Polished Chrome Base	Add -PCIB	\$501	
Wire Frame Pull-Out Waste/Recycling Unit Conference and Buffet Height Credenzas (excludes 36" width)			
(1) 20" Depth Single Wire Frame Unit	Add -TF1	\$309	Located in the rightmost cabinet, behind the right door
(1) 24" Depth Double Wire Frame Unit	Add -TF2	\$477	Located in the rightmost cabinet, behind the right door
Dual Wire Frame Pull-Out Waste/Recycling Units Conference and Buffet Height Credenzas (Excludes 36"-54" width)			
(2) 20" Depth Single Wire Frame Units	Add -TF3	\$617	Located in the rightmost cabinet, behind left and right doors
(2) 24" Depth Double Wire Frame Units	Add -TF4	\$954	Located in the rightmost cabinet, behind left and right doors
24" Depth Equipment Rack Options Available on Buffet Height Credenzas			
Fixed Equipment Rack	Add -R2	\$947	Located in left most cabinet, behind left and right doors
Sliding Equipment Rack	Add -R1	\$3,467	Located in left most cabinet, behind left and right doors

ADDITIONAL HANDLE PULL OPTIONS

Wood Frame Pull-Out Waste/Recycling Bin Unit Conference and Buffet Height Credenzas (Excludes 36" width)			
(1) 20" Depth Single Wood Frame Unit	Add -FWTF1	\$817	Located in the rightmost cabinet, applied to right door
(1) 24" Depth Double Wood Frame Unit	Add -FWTF2	\$1,225	Located in the rightmost cabinet, applied to right door
Dual Wood Frame Pull-Out Waste/Recycling Bin Unit Conference and Buffet Height Credenzas (Excludes 36"-54" width)			
(2) 20" Depth Single Wood Frame Units	Add -FWTF3	\$1,633	Located in the rightmost cabinet, applied to left and right doors
(2) 24" Depth Double Wood Frame Units	Add -FWTF4	\$2,450	Located in the rightmost cabinet, applied to left and right doors
24" Depth Single Pull-Out Drawer Refrigerator Available on Conference and Buffet Height Credenzas			
Pull-Out Drawer Refrigerator	Add -FWOM24	\$7,327	Located in left most cabinet, includes applied door panel

EDGE PROFILE



Glass Top Edge

REQUIRED INFORMATION (ORDER CANNOT BE ENTERED WITHOUT THIS INFORMATION)

See appendix pages vi-viii for surface material options.

- Choose Door Style: Defaults to case finish, if none selected
- Choose Pull Style: Defaults to Push Latch, if none selected
- Choose Metal Finish
- Choose Glass Finish
- Choose Paint Finish, if specified
- Choose Veneer Finish, if specified

GENERAL INFORMATION

- Glass is 1/4"-thick back-painted, low-iron glass
- When veneer case is specified, the case exterior is standard slip-match layout regardless of veneer door style selection
- Pull-Out Waste/Recycling Bin size: 17-7/8" x 8-3/32" x 11-9/16"; (1) 35 Qt.; Double Pull-Out Waste/Recycling Units include two bins
- When lock option is specified, color will default based on leg finish:
 - Aged Bronze, Black, Galaxy, Shadow, and Storm: Black
 - Cloud: White
 - Burnish, Foil, and Satin Bronze: Satin Nickel
 - Chrome: Polished Nickel
- Credenzas include one adjustable shelf behind each door unless other components are specified
- Equipment racks hold 12RU and include a thermostatically controlled fan and plug strip



GLOSS GLASS TOP

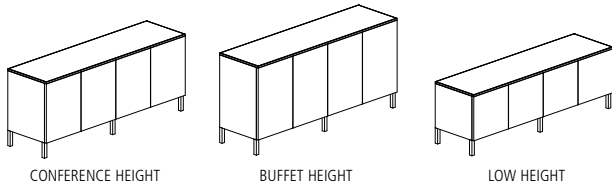

CASE MATERIAL KEY

PA-OB Painted Case with Edge-mount Post Leg
 V-OB Veneer Case with Edge-mount Post Leg

EDGE-MOUNT POST LEG

MODEL #	W x D x H	DESCRIPTION	-PA-OB	-V-OB
CONFERENCE HEIGHT (23.5 IN. CASE WITH 6.5 IN. EDGE-MOUNT POST LEG)				
FWLC-3629-GG	36 x 20 x 30	Two Door	6,260	6,904
FWLC-5429-GG	54 x 20 x 30	Three Door	8,007	8,847
FWLC-7229-GG	72 x 20 x 30	Four Door	9,759	10,790
FWLC-9029-GG	90 x 20 x 30	Five Door	11,509	12,734
FWLD-3629-GG	36 x 24 x 30	Two Door	6,837	7,542
FWLD-5429-GG	54 x 24 x 30	Three Door	8,763	9,683
FWLD-7229-GG	72 x 24 x 30	Four Door	10,688	11,822
FWLD-9029-GG	90 x 24 x 30	Five Door	12,611	13,955
BUFFET HEIGHT (28.5 IN. CASE WITH 6.5 IN. EDGE-MOUNT POST LEG)				
FWCC-3636-GG	36 x 20 x 35	Two Door	6,724	7,415
FWCC-5436-GG	54 x 20 x 35	Three Door	8,611	9,517
FWCC-7236-GG	72 x 20 x 35	Four Door	10,502	11,617
FWCC-9036-GG	90 x 20 x 35	Five Door	12,389	13,713
FWCD-3636-GG	36 x 24 x 35	Two Door	7,349	8,111
FWCD-5436-GG	54 x 24 x 35	Three Door	9,426	10,417
FWCD-7236-GG	72 x 24 x 35	Four Door	11,505	12,729
FWCD-9036-GG	90 x 24 x 35	Five Door	13,583	15,037
LOW HEIGHT (17.5 IN. CASE WITH 6.5 IN. EDGE-MOUNT POST LEG)				
FWWC-3624-GG	36 x 20 x 24	Two Door	5,786	6,376
FWWC-5424-GG	54 x 20 x 24	Three Door	7,393	8,159
FWWC-7224-GG	72 x 20 x 24	Four Door	8,998	9,944
FWWC-9024-GG	90 x 20 x 24	Five Door	10,603	11,729

DOOR STYLE

DESCRIPTION	CODE	NOTES	PRICE
Vertical Veneer	-VD		No Charge
Horizontal Veneer	-HD		No Charge
Veneer/Paint Combination	-VPD	Reference page 8 for predetermined accent door locations	No Charge
Painted	-PAD		No Charge

PULL STYLE

DESCRIPTION	CODE	NOTES	TWO DOOR	THREE DOOR	FOUR DOOR	FIVE DOOR
Push Latch	No Code	Push to open (no pull). Applied to all doors.	No Charge	No Charge	No Charge	No Charge
Handle Pull - Powder Coat	-HP	Pull to open. Applied to all doors.	\$157	\$236	\$314	\$392
Handle Pull - High Polish Finish	-HP-HPF	Pull to open. Applied to all doors.	\$277	\$416	\$554	\$693
Handle Pull - Clear Anodized	-HP-CA	Pull to open. Applied to all doors.	\$157	\$236	\$314	\$392
Handle Pull - Goldmatt Anodized	-HP-GMA	Pull to open. Applied to all doors.	\$230	\$345	\$460	\$575
Handle Pull - Antique Brass Anodized	-HP-ABA	Pull to open. Applied to all doors.	\$230	\$345	\$460	\$575
Handle Pull - Light Bronze Anodized	-HP-LBA	Pull to open. Applied to all doors.	\$230	\$345	\$460	\$575



GLOSS GLASS TOP

PUSH LATCH OR HANDLE PULL OPTIONS	CODE	PRICE	NOTES
Locks	Add -LK	\$315	Locks included in all cabinets
Polished Chrome Base	Add -PCOB	\$541	
Wire Frame Pull-Out Waste/Recycling Unit Conference and Buffet Height Credenzas (excludes 36" width)			
(1) 20" Depth Single Wire Frame Unit	Add -TF1	\$309	Located in the rightmost cabinet, behind the right door
(1) 24" Depth Double Wire Frame Unit	Add -TF2	\$477	Located in the rightmost cabinet, behind the right door
Dual Wire Frame Pull-Out Waste/Recycling Units Conference and Buffet Height Credenzas (Excludes 36"-54" width)			
(2) 20" Depth Single Wire Frame Units	Add -TF3	\$617	Located in the rightmost cabinet, behind left and right doors
(2) 24" Depth Double Wire Frame Units	Add -TF4	\$954	Located in the rightmost cabinet, behind left and right doors
24" Depth Equipment Rack Options Available on Buffet Height Credenzas			
Fixed Equipment Rack	Add -R2	\$947	Located in left most cabinet, behind left and right doors
Sliding Equipment Rack	Add -R1	\$3,467	Located in left most cabinet, behind left and right doors

ADDITIONAL HANDLE PULL OPTIONS

Wood Frame Pull-Out Waste/Recycling Bin Unit Conference and Buffet Height Credenzas (Excludes 36" width)			
(1) 20" Depth Single Wood Frame Unit	Add -FWTF1	\$817	Located in the rightmost cabinet, applied to right door
(1) 24" Depth Double Wood Frame Unit	Add -FWTF2	\$1,225	Located in the rightmost cabinet, applied to right door
Dual Wood Frame Pull-Out Waste/Recycling Bin Unit Conference and Buffet Height Credenzas (Excludes 36"-54" width)			
(2) 20" Depth Single Wood Frame Units	Add -FWTF3	\$1,633	Located in the rightmost cabinet, applied to left and right doors
(2) 24" Depth Double Wood Frame Units	Add -FWTF4	\$2,450	Located in the rightmost cabinet, applied to left and right doors
24" Depth Single Pull-Out Drawer Refrigerator Available on Conference and Buffet Height Credenzas			
Pull-Out Drawer Refrigerator	Add -FWOM24	\$7,327	Located in left most cabinet, includes applied door panel

EDGE PROFILE



Glass Top Edge

REQUIRED INFORMATION (ORDER CANNOT BE ENTERED WITHOUT THIS INFORMATION)

See appendix pages vi-viii for surface material options.

- Choose Door Style: Defaults to case finish, if none selected
- Choose Pull Style: Defaults to Push Latch, if none selected
- Choose Metal Finish
- Choose Glass Finish
- Choose Paint Finish, if specified
- Choose Veneer Finish, if specified

GENERAL INFORMATION

- Glass is 1/4" -thick back-painted, low-iron glass
- When veneer case is specified, the case exterior is standard slip-match layout regardless of veneer door style selection
- Pull-Out Waste/Recycling Bin size: 17-7/8" x 8-3/32" x 11-9/16"; (1) 35 Qt.; Double Pull-Out Waste/Recycling Units include two bins
- When lock option is specified, color will default based on leg finish:
 - Aged Bronze, Black, Galaxy, Shadow, and Storm: Black
 - Cloud: White
 - Burnish, Foil, and Satin Bronze: Satin Nickel
 - Chrome: Polished Nickel
- Credenzas include one adjustable shelf behind each door unless other components are specified
- Equipment racks hold 12RU and include a thermostatically controlled fan and plug strip



GLOSS GLASS TOP

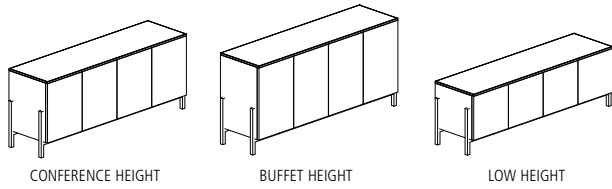

CASE MATERIAL KEY

PA-CB Painted Case with Cradle Base
 V-CB Veneer Case with Cradle Base

CRADLE BASE

MODEL #	W x D x H	DESCRIPTION	-PA-CB	-V-CB
CONFERENCE HEIGHT (23.5 IN. CASE WITH 6.5 IN. CRADLE BASE)				
FWLC-3629-GG	36 x 20 x 30	Two Doors	6,882	7,523
FWLC-5429-GG	54 x 20 x 30	Three Doors	8,628	9,465
FWLC-7229-GG	72 x 20 x 30	Four Doors	10,379	11,410
FWLC-9029-GG	90 x 20 x 30	Five Doors	12,129	13,354
FWLD-3629-GG	36 x 24 x 30	Two Doors	7,462	8,166
FWLD-5429-GG	54 x 24 x 30	Three Doors	9,381	10,303
FWLD-7229-GG	72 x 24 x 30	Four Doors	11,305	12,441
FWLD-9029-GG	90 x 24 x 30	Five Doors	13,230	14,578
BUFFET HEIGHT (28.5 IN. CASE WITH 6.5 IN. CRADLE BASE)				
FWCC-3636-GG	36 x 20 x 35	Two Doors	7,345	8,037
FWCC-5436-GG	54 x 20 x 35	Three Doors	9,231	10,135
FWCC-7236-GG	72 x 20 x 35	Four Doors	11,119	12,235
FWCC-9036-GG	90 x 20 x 35	Five Doors	13,009	14,334
FWCD-3636-GG	36 x 24 x 35	Two Doors	7,969	8,730
FWCD-5436-GG	54 x 24 x 35	Three Doors	10,045	11,039
FWCD-7236-GG	72 x 24 x 35	Four Doors	12,124	13,348
FWCD-9036-GG	90 x 24 x 35	Five Doors	14,202	15,657
LOW HEIGHT (17.5 IN. CASE WITH 6.5 IN. CRADLE BASE)				
FWWC-3624-GG	36 x 20 x 24	Two Doors	6,405	6,996
FWWC-5424-GG	54 x 20 x 24	Three Doors	8,016	8,778
FWWC-7224-GG	72 x 20 x 24	Four Doors	9,616	10,562
FWWC-9024-GG	90 x 20 x 24	Five Doors	11,224	12,349

DOOR STYLE

DESCRIPTION	CODE	NOTES	PRICE
Vertical Veneer	-VD		No Charge
Horizontal Veneer	-HD		No Charge
Veneer/Paint Combination	-VPD	Reference page 8 for predetermined accent door locations	No Charge
Painted	-PAD		No Charge

PULL STYLE

DESCRIPTION	CODE	NOTES	TWO DOOR	THREE DOOR	FOUR DOOR	FIVE DOOR
Push Latch	No Code	Push to open (no pull). Applied to all doors.	No Charge	No Charge	No Charge	No Charge
Handle Pull - Powder Coat	-HP	Pull to open. Applied to all doors.	\$157	\$236	\$314	\$392
Handle Pull - High Polish Finish	-HP-HPF	Pull to open. Applied to all doors.	\$277	\$416	\$554	\$693
Handle Pull - Clear Anodized	-HP-CA	Pull to open. Applied to all doors.	\$157	\$236	\$314	\$392
Handle Pull - Goldmatt Anodized	-HP-GMA	Pull to open. Applied to all doors.	\$230	\$345	\$460	\$575
Handle Pull - Antique Brass Anodized	-HP-ABA	Pull to open. Applied to all doors.	\$230	\$345	\$460	\$575
Handle Pull - Light Bronze Anodized	-HP-LBA	Pull to open. Applied to all doors.	\$230	\$345	\$460	\$575



GLOSS GLASS TOP

PUSH LATCH OR HANDLE PULL OPTIONS	CODE	PRICE	NOTES
Locks	Add -LK	\$315	Locks included in all cabinets
Polished Chrome Base	Add -PCCB	\$1,775	
Wire Frame Pull-Out Waste/Recycling Unit Conference and Buffet Height Credenzas (excludes 36" width)			
(1) 20" Depth Single Wire Frame Unit	Add -TF1	\$309	Located in the rightmost cabinet, behind the right door
(1) 24" Depth Double Wire Frame Unit	Add -TF2	\$477	Located in the rightmost cabinet, behind the right door
Dual Wire Frame Pull-Out Waste/Recycling Units Conference and Buffet Height Credenzas (Excludes 36"-54" width)			
(2) 20" Depth Single Wire Frame Units	Add -TF3	\$617	Located in the rightmost cabinet, behind left and right doors
(2) 24" Depth Double Wire Frame Units	Add -TF4	\$954	Located in the rightmost cabinet, behind left and right doors
24" Depth Equipment Rack Options Available on Buffet Height Credenzas			
Fixed Equipment Rack	Add -R2	\$947	Located in left most cabinet, behind left and right doors
Sliding Equipment Rack	Add -R1	\$3,467	Located in left most cabinet, behind left and right doors

ADDITIONAL HANDLE PULL OPTIONS

Wood Frame Pull-Out Waste/Recycling Bin Unit Conference and Buffet Height Credenzas (Excludes 36" width)			
(1) 20" Depth Single Wood Frame Unit	Add -FWTF1	\$817	Located in the rightmost cabinet, applied to right door
(1) 24" Depth Double Wood Frame Unit	Add -FWTF2	\$1,225	Located in the rightmost cabinet, applied to right door
Dual Wood Frame Pull-Out Waste/Recycling Bin Unit Conference and Buffet Height Credenzas (Excludes 36"-54" width)			
(2) 20" Depth Single Wood Frame Units	Add -FWTF3	\$1,633	Located in the rightmost cabinet, applied to left and right doors
(2) 24" Depth Double Wood Frame Units	Add -FWTF4	\$2,450	Located in the rightmost cabinet, applied to left and right doors
24" Depth Single Pull-Out Drawer Refrigerator Available on Conference and Buffet Height Credenzas			
Pull-Out Drawer Refrigerator	Add -FWOM24	\$7,327	Located in left most cabinet, includes applied door panel

EDGE PROFILE



Glass Top Edge

REQUIRED INFORMATION (ORDER CANNOT BE ENTERED WITHOUT THIS INFORMATION)

See appendix pages vi-viii for surface material options.

- Choose Door Style: Defaults to case finish, if none selected
- Choose Pull Style: Defaults to Push Latch, if none selected
- Choose Metal Finish
- Choose Glass Finish
- Choose Paint Finish, if specified
- Choose Veneer Finish, if specified

GENERAL INFORMATION

- Glass is 1/4"-thick back-painted, low-iron glass
- When veneer case is specified, the case exterior is standard slip-match layout regardless of veneer door style selection
- Pull-Out Waste/Recycling Bin size: 17-7/8" x 8-3/32" x 11-9/16"; (1) 35 Qt.; Double Pull-Out Waste/Recycling Units include two bins
- When lock option is specified, color will default based on leg finish:
 - Aged Bronze, Black, Galaxy, Shadow, and Storm: Black
 - Cloud: White
 - Burnish, Foil, and Satin Bronze: Satin Nickel
 - Chrome: Polished Nickel
- Credenzas include one adjustable shelf behind each door unless other components are specified
- Equipment racks hold 12RU and include a thermostatically controlled fan and plug strip



GLOSS GLASS TOP

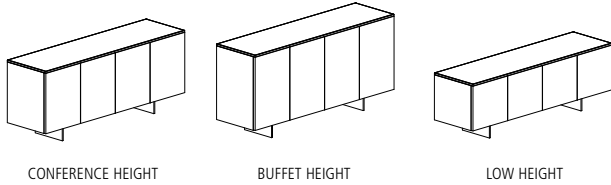

CASE MATERIAL KEY

PA-BB Painted Case with Blade Base
 V-BB Veneer Case with Blade Base

BLADE BASE

MODEL #	W x D x H	DESCRIPTION	-PA-BB	-V-BB
CONFERENCE HEIGHT (23.5 IN. CASE WITH 6 IN. BLADE BASE)				
FWLC-3629-GG	36 x 20 x 29.5	Two Doors	6,569	7,213
FWLC-5429-GG	54 x 20 x 29.5	Three Doors	8,319	9,154
FWLC-7229-GG	72 x 20 x 29.5	Four Doors	10,067	11,099
FWLC-9029-GG	90 x 20 x 29.5	Five Doors	11,818	13,044
FWLD-3629-GG	36 x 24 x 29.5	Two Doors	7,150	7,855
FWLD-5429-GG	54 x 24 x 29.5	Three Doors	9,071	9,990
FWLD-7229-GG	72 x 24 x 29.5	Four Doors	10,996	12,131
FWLD-9029-GG	90 x 24 x 29.5	Five Doors	12,921	14,267
BUFFET HEIGHT (28.5 IN. CASE WITH 6 IN. BLADE BASE)				
FWCC-3636-GG	36 x 20 x 34.5	Two Doors	7,035	7,727
FWCC-5436-GG	54 x 20 x 34.5	Three Doors	8,922	9,827
FWCC-7236-GG	72 x 20 x 34.5	Four Doors	10,811	11,924
FWCC-9036-GG	90 x 20 x 34.5	Five Doors	12,699	14,023
FWCD-3636-GG	36 x 24 x 34.5	Two Doors	7,659	8,422
FWCD-5436-GG	54 x 24 x 34.5	Three Doors	9,735	10,728
FWCD-7236-GG	72 x 24 x 34.5	Four Doors	11,812	13,038
FWCD-9036-GG	90 x 24 x 34.5	Five Doors	13,892	15,347
LOW HEIGHT (17.5 IN. CASE WITH 6 IN. BLADE BASE)				
FWWC-3624-GG	36 x 20 x 23.5	Two Doors	5,323	6,683
FWWC-5424-GG	54 x 20 x 23.5	Three Doors	6,928	8,468
FWWC-7224-GG	72 x 20 x 23.5	Four Doors	8,531	10,254
FWWC-9024-GG	90 x 20 x 23.5	Five Doors	10,138	12,036

DOOR STYLE

DESCRIPTION	CODE	NOTES	PRICE
Vertical Veneer	-VD		No Charge
Horizontal Veneer	-HD		No Charge
Veneer/Paint Combination	-VPD	Reference page 8 for predetermined accent door locations	No Charge
Painted	-PAD		No Charge

PULL STYLE

DESCRIPTION	CODE	NOTES	TWO DOOR	THREE DOOR	FOUR DOOR	FIVE DOOR
Push Latch	No Code	Push to open (no pull). Applied to all doors.	No Charge	No Charge	No Charge	No Charge
Handle Pull - Powder Coat	-HP	Pull to open. Applied to all doors.	\$157	\$236	\$314	\$392
Handle Pull - High Polish Finish	-HP-HPF	Pull to open. Applied to all doors.	\$277	\$416	\$554	\$693
Handle Pull - Clear Anodized	-HP-CA	Pull to open. Applied to all doors.	\$157	\$236	\$314	\$392
Handle Pull - Goldmatt Anodized	-HP-GMA	Pull to open. Applied to all doors.	\$230	\$345	\$460	\$575
Handle Pull - Antique Brass Anodized	-HP-ABA	Pull to open. Applied to all doors.	\$230	\$345	\$460	\$575
Handle Pull - Light Bronze Anodized	-HP-LBA	Pull to open. Applied to all doors.	\$230	\$345	\$460	\$575



GLOSS GLASS TOP

PUSH LATCH OR HANDLE PULL OPTIONS	CODE	PRICE	NOTES
Locks	Add -LK	\$315	Locks included in all cabinets
Polished Chrome Base	Add -PCBB	\$501	
Wire Frame Pull-Out Waste/Recycling Unit Conference and Buffet Height Credenzas (excludes 36" width)			
(1) 20" Depth Single Wire Frame Unit	Add -TF1	\$309	Located in the rightmost cabinet, behind the right door
(1) 24" Depth Double Wire Frame Unit	Add -TF2	\$477	Located in the rightmost cabinet, behind the right door
Dual Wire Frame Pull-Out Waste/Recycling Units Conference and Buffet Height Credenzas (Excludes 36"-54" width)			
(2) 20" Depth Single Wire Frame Units	Add -TF3	\$617	Located in the rightmost cabinet, behind left and right doors
(2) 24" Depth Double Wire Frame Units	Add -TF4	\$954	Located in the rightmost cabinet, behind left and right doors
24" Depth Equipment Rack Options Available on Buffet Height Credenzas			
Fixed Equipment Rack	Add -R2	\$947	Located in left most cabinet, behind left and right doors
Sliding Equipment Rack	Add -R1	\$3,467	Located in left most cabinet, behind left and right doors

ADDITIONAL HANDLE PULL OPTIONS

Wood Frame Pull-Out Waste/Recycling Bin Unit Conference and Buffet Height Credenzas (Excludes 36" width)			
(1) 20" Depth Single Wood Frame Unit	Add -FWTF1	\$817	Located in the rightmost cabinet, applied to right door
(1) 24" Depth Double Wood Frame Unit	Add -FWTF2	\$1,225	Located in the rightmost cabinet, applied to right door
Dual Wood Frame Pull-Out Waste/Recycling Bin Unit Conference and Buffet Height Credenzas (Excludes 36"-54" width)			
(2) 20" Depth Single Wood Frame Units	Add -FWTF3	\$1,633	Located in the rightmost cabinet, applied to left and right doors
(2) 24" Depth Double Wood Frame Units	Add -FWTF4	\$2,450	Located in the rightmost cabinet, applied to left and right doors
24" Depth Single Pull-Out Drawer Refrigerator Available on Conference and Buffet Height Credenzas			
Pull-Out Drawer Refrigerator	Add -FWOM24	\$7,327	Located in left most cabinet, includes applied door panel

EDGE PROFILE



Glass Top Edge

REQUIRED INFORMATION (ORDER CANNOT BE ENTERED WITHOUT THIS INFORMATION)

See appendix pages vi-viii for surface material options.

- Choose Door Style: Defaults to case finish, if none selected
- Choose Pull Style: Defaults to Push Latch, if none selected
- Choose Metal Finish
- Choose Glass Finish
- Choose Paint Finish, if specified
- Choose Veneer Finish, if specified

GENERAL INFORMATION

- Glass is 1/4"-thick back-painted, low-iron glass
- When veneer case is specified, the case exterior is standard slip-match layout regardless of veneer door style selection
- Pull-Out Waste/Recycling Bin size: 17-7/8" x 8-3/32" x 11-9/16"; (1) 35 Qt.; Double Pull-Out Waste/Recycling Units include two bins
- When lock option is specified, color will default based on leg finish:
 - Aged Bronze, Black, Galaxy, Shadow, and Storm: Black
 - Cloud: White
 - Burnish, Foil, and Satin Bronze: Satin Nickel
 - Chrome: Polished Nickel
- Credenzas include one adjustable shelf behind each door unless other components are specified
- Equipment racks hold 12RU and include a thermostatically controlled fan and plug strip



SATIN GLASS TOP

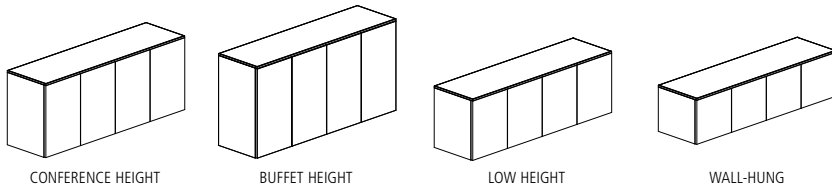

CASE MATERIAL KEY

PA Painted Case
V Veneer Case

CASE ONLY

MODEL #	W x D x H	DESCRIPTION	-PA	-V
CONFERENCE HEIGHT (29 INCH CASE)				
FWCC-3629-SG	36 x 20 x 29	Two Doors	6,584	7,299
FWCC-5429-SG	54 x 20 x 29	Three Doors	8,572	9,501
FWCC-7229-SG	72 x 20 x 29	Four Doors	10,560	11,706
FWCC-9029-SG	90 x 20 x 29	Five Doors	12,548	13,909
FWCD-3629-SG	36 x 24 x 29	Two Doors	7,241	8,028
FWCD-5429-SG	54 x 24 x 29	Three Doors	9,428	10,452
FWCD-7229-SG	72 x 24 x 29	Four Doors	11,618	12,877
FWCD-9029-SG	90 x 24 x 29	Five Doors	13,801	15,299
BUFFET HEIGHT (36 INCH CASE)				
FWBC-3636-SG	36 x 20 x 36	Two Doors	7,572	8,391
FWBC-5436-SG	54 x 20 x 36	Three Doors	9,855	10,922
FWBC-7236-SG	72 x 20 x 36	Four Doors	12,139	13,459
FWBC-9036-SG	90 x 20 x 36	Five Doors	14,428	15,994
FWBD-3636-SG	36 x 24 x 36	Two Doors	8,327	9,229
FWBD-5436-SG	54 x 24 x 36	Three Doors	10,837	12,016
FWBD-7236-SG	72 x 24 x 36	Four Doors	13,356	14,803
FWBD-9036-SG	90 x 24 x 36	Five Doors	15,870	17,595
LOW HEIGHT (24 INCH CASE)				
FWLC-3624-SG	36 x 20 x 24	Two Doors	6,098	6,760
FWLC-5424-SG	54 x 20 x 24	Three Doors	7,937	8,798
FWLC-7224-SG	72 x 20 x 24	Four Doors	9,776	10,837
FWLC-9024-SG	90 x 20 x 24	Five Doors	11,620	12,882
FWLD-3624-SG	36 x 24 x 24	Two Doors	6,705	7,435
FWLD-5424-SG	54 x 24 x 24	Three Doors	8,729	9,677
FWLD-7224-SG	72 x 24 x 24	Four Doors	10,754	11,924
FWLD-9024-SG	90 x 24 x 24	Five Doors	12,780	14,169
WALL-HUNG (17.5 INCH CASE)				
FWWC-3618-SG	36 x 20 x 17.5	Two Doors	5,600	6,204
FWWC-5418-SG	54 x 20 x 17.5	Three Doors	7,291	8,079
FWWC-7218-SG	72 x 20 x 17.5	Four Doors	8,977	10,488
FWWC-9018-SG	90 x 20 x 17.5	Five Doors	10,668	11,826

DOOR STYLE

DESCRIPTION	CODE	NOTES	PRICE
Vertical Veneer	-VD		No Charge
Horizontal Veneer	-HD		No Charge
Veneer/Paint Combination	-VPD	Reference page 8 for predetermined accent door locations	No Charge
Painted	-PAD		No Charge

PULL STYLE

DESCRIPTION	CODE	NOTES	TWO DOOR	THREE DOOR	FOUR DOOR	FIVE DOOR
Push Latch	No Code	Push to open (no pull). Applied to all doors.	No Charge	No Charge	No Charge	No Charge
Handle Pull - Powder Coat	-HP	Pull to open. Applied to all doors.	\$157	\$236	\$314	\$392
Handle Pull - High Polish Finish	-HP-HPF	Pull to open. Applied to all doors.	\$277	\$416	\$554	\$693
Handle Pull - Clear Anodized	-HP-CA	Pull to open. Applied to all doors.	\$157	\$236	\$314	\$392
Handle Pull - Goldmatt Anodized	-HP-GMA	Pull to open. Applied to all doors.	\$230	\$345	\$460	\$575
Handle Pull - Antique Brass Anodized	-HP-ABA	Pull to open. Applied to all doors.	\$230	\$345	\$460	\$575
Handle Pull - Light Bronze Anodized	-HP-LBA	Pull to open. Applied to all doors.	\$230	\$345	\$460	\$575



SATIN GLASS TOP

PUSH LATCH OR HANDLE PULL OPTIONS	CODE	PRICE	NOTES
Locks	Add -LK	\$315	Locks included in all cabinets
Drawers Behind Doors	Add -D	\$614	Available on Buffet Height Credenza
Wire Frame Pull-Out Waste/Recycling Unit Conference, Buffet, and Low Height Credenzas (excludes 36" width)			
(1) 20" Depth Single Wire Frame Unit	Add -TF1	\$309	Located in the rightmost cabinet, behind the right door
(1) 24" Depth Double Wire Frame Unit	Add -TF2	\$477	Located in the rightmost cabinet, behind the right door
Dual Wire Frame Pull-Out Waste/Recycling Units Conference, Buffet, and Low Height Credenzas (Excludes 36"-54" width)			
(2) 20" Depth Single Wire Frame Units	Add -TF3	\$617	Located in the rightmost cabinet, behind left and right doors
(2) 24" Depth Double Wire Frame Units	Add -TF4	\$954	Located in the rightmost cabinet, behind left and right doors
24" Depth Equipment Rack Options Available on Conference and Buffet Height Credenzas			
Fixed Equipment Rack	Add -R2	\$947	Located in left most cabinet, behind left and right doors
Sliding Equipment Rack	Add -R1	\$3,467	Located in left most cabinet, behind left and right doors

ADDITIONAL HANDLE PULL OPTIONS

Wood Frame Pull-Out Waste/Recycling Bin Unit Conference, Buffet, and Low Height Credenzas (Excludes 36" width)			
(1) 20" Depth Single Wood Frame Unit	Add -FWTF1	\$817	Located in the rightmost cabinet, applied to right door
(1) 24" Depth Double Wood Frame Unit	Add -FWTF2	\$1,225	Located in the rightmost cabinet, applied to right door
Dual Wood Frame Pull-Out Waste/Recycling Bin Unit Conference, Buffet, and Low Height Credenzas (Excludes 36"-54" width)			
(2) 20" Depth Single Wood Frame Units	Add -FWTF3	\$1,633	Located in the rightmost cabinet, applied to left and right doors
(2) 24" Depth Double Wood Frame Units	Add -FWTF4	\$2,450	Located in the rightmost cabinet, applied to left and right doors
24" Depth Single Pull-Out Drawer Refrigerator Available on Conference and Low Height Credenzas			
Pull-Out Drawer Refrigerator	Add -FWOM24	\$7,327	Located in left most cabinet, includes applied door panel

EDGE PROFILE



Glass Top Edge

REQUIRED INFORMATION (ORDER CANNOT BE ENTERED WITHOUT THIS INFORMATION)

See appendix pages vi-viii for surface material options.

- Choose Door Style: Defaults to case finish, if none selected
- Choose Pull Style: Defaults to Push Latch, if none selected
- Choose Glass Finish
- Choose Paint Finish, if specified
- Choose Veneer Finish, if specified

GENERAL INFORMATION

- Glass is 1/4" -thick back-painted, low-iron glass
- When veneer case is specified, the case exterior is standard slip-match layup regardless of veneer door style selection
- Pull-Out Waste/Recycling Bin size: 17-7/8" x 8-3/32" x 11-9/16"; (1) 35 Qt.; Double Pull-Out Waste/Recycling Units include two bins
- Locks
 - Veneer (Case Only) - When lock option is specified, color will default to Satin Nickel
 - Painted (Case Only) - When lock option is specified, color will default based on Paint finish:
 - Aged Bronze, Black, Galaxy, Shadow, and Storm: Black
 - Cloud: White
 - Burnish, Foil, Satin Bronze: Satin Nickel
 - Chrome: Polished Nickel
- Credenzas include one adjustable shelf behind each door unless other components are specified
- Equipment racks hold 12RU and include a thermostatically controlled fan and plug strip



SATIN GLASS TOP

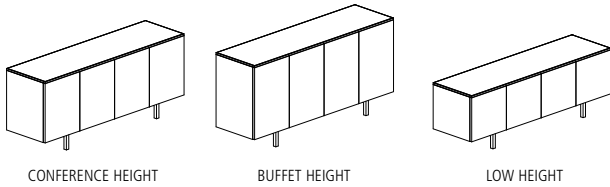

CASE MATERIAL KEY

PA-IB Painted Case with Inset Leg
 V-IB Veneer Case with Inset Leg

INSET LEG

MODEL #	W x D x H	DESCRIPTION	-PA-IB	-V-IB
CONFERENCE HEIGHT (23.5 IN. CASE WITH 6.5 IN. INSET LEG)				
FWLC-3629-SG	36 x 20 x 30	Two Doors	6,562	7,224
FWLC-5429-SG	54 x 20 x 30	Three Doors	8,401	9,261
FWLC-7229-SG	72 x 20 x 30	Four Doors	10,240	11,301
FWLC-9029-SG	90 x 20 x 30	Five Doors	12,082	13,345
FWLD-3629-SG	36 x 24 x 30	Two Doors	7,173	7,900
FWLD-5429-SG	54 x 24 x 30	Three Doors	9,193	10,141
FWLD-7229-SG	72 x 24 x 30	Four Doors	11,220	12,388
FWLD-9029-SG	90 x 24 x 30	Five Doors	13,245	14,633
BUFFET HEIGHT (28.5 IN. CASE WITH 6.5 IN. INSET LEG)				
FWCC-3636-SG	36 x 20 x 35	Two Doors	7,050	7,765
FWCC-5436-SG	54 x 20 x 35	Three Doors	9,035	9,967
FWCC-7236-SG	72 x 20 x 35	Four Doors	11,024	12,171
FWCC-9036-SG	90 x 20 x 35	Five Doors	13,012	14,376
FWCD-3636-SG	36 x 24 x 35	Two Doors	7,707	8,493
FWCD-5436-SG	54 x 24 x 35	Three Doors	9,892	10,918
FWCD-7236-SG	72 x 24 x 35	Four Doors	12,081	13,341
FWCD-9036-SG	90 x 24 x 35	Five Doors	14,267	15,764
LOW HEIGHT (17.5 IN. CASE WITH 6.5 IN. INSET LEG)				
FWWC-3624-SG	36 x 20 x 24	Two Doors	6,065	6,670
FWWC-5424-SG	54 x 20 x 24	Three Doors	7,755	8,542
FWWC-7224-SG	72 x 20 x 24	Four Doors	9,443	10,954
FWWC-9024-SG	90 x 20 x 24	Five Doors	11,131	12,290

DOOR STYLE

DESCRIPTION	CODE	NOTES	PRICE
Vertical Veneer	-VD		No Charge
Horizontal Veneer	-HD		No Charge
Veneer/Paint Combination	-VPD	Reference page 8 for predetermined accent door locations	No Charge
Painted	-PAD		No Charge

PULL STYLE

DESCRIPTION	CODE	NOTES	TWO DOOR	THREE DOOR	FOUR DOOR	FIVE DOOR
Push Latch	No Code	Push to open (no pull). Applied to all doors.	No Charge	No Charge	No Charge	No Charge
Handle Pull - Powder Coat	-HP	Pull to open. Applied to all doors.	\$157	\$236	\$314	\$392
Handle Pull - High Polish Finish	-HP-HPF	Pull to open. Applied to all doors.	\$277	\$416	\$554	\$693
Handle Pull - Clear Anodized	-HP-CA	Pull to open. Applied to all doors.	\$157	\$236	\$314	\$392
Handle Pull - Goldmatt Anodized	-HP-GMA	Pull to open. Applied to all doors.	\$230	\$345	\$460	\$575
Handle Pull - Antique Brass Anodized	-HP-ABA	Pull to open. Applied to all doors.	\$230	\$345	\$460	\$575
Handle Pull - Light Bronze Anodized	-HP-LBA	Pull to open. Applied to all doors.	\$230	\$345	\$460	\$575



SATIN GLASS TOP

PUSH LATCH OR HANDLE PULL OPTIONS	CODE	PRICE	NOTES
Locks	Add -LK	\$315	Locks included in all cabinets
Polished Chrome Base	Add -PCIB	\$501	
Wire Frame Pull-Out Waste/Recycling Unit Conference and Buffet Height Credenzas (excludes 36" width)			
(1) 20" Depth Single Wire Frame Unit	Add -TF1	\$309	Located in the rightmost cabinet, behind the right door
(1) 24" Depth Double Wire Frame Unit	Add -TF2	\$477	Located in the rightmost cabinet, behind the right door
Dual Wire Frame Pull-Out Waste/Recycling Units Conference and Buffet Height Credenzas (Excludes 36"-54" width)			
(2) 20" Depth Single Wire Frame Units	Add -TF3	\$617	Located in the rightmost cabinet, behind left and right doors
(2) 24" Depth Double Wire Frame Units	Add -TF4	\$954	Located in the rightmost cabinet, behind left and right doors
24" Depth Equipment Rack Options Available on Buffet Height Credenzas			
Fixed Equipment Rack	Add -R2	\$947	Located in left most cabinet, behind left and right doors
Sliding Equipment Rack	Add -R1	\$3,467	Located in left most cabinet, behind left and right doors

ADDITIONAL HANDLE PULL OPTIONS

Wood Frame Pull-Out Waste/Recycling Bin Unit Conference and Buffet Height Credenzas (Excludes 36" width)			
(1) 20" Depth Single Wood Frame Unit	Add -FWTF1	\$817	Located in the rightmost cabinet, applied to right door
(1) 24" Depth Double Wood Frame Unit	Add -FWTF2	\$1,225	Located in the rightmost cabinet, applied to right door
Dual Wood Frame Pull-Out Waste/Recycling Bin Unit Conference and Buffet Height Credenzas (Excludes 36"-54" width)			
(2) 20" Depth Single Wood Frame Units	Add -FWTF3	\$1,633	Located in the rightmost cabinet, applied to left and right doors
(2) 24" Depth Double Wood Frame Units	Add -FWTF4	\$2,450	Located in the rightmost cabinet, applied to left and right doors
24" Depth Single Pull-Out Drawer Refrigerator Available on Conference and Buffet Height Credenzas			
Pull-Out Drawer Refrigerator	Add -FWOM24	\$7,327	Located in left most cabinet, includes applied door panel

EDGE PROFILE



Glass Top Edge

REQUIRED INFORMATION (ORDER CANNOT BE ENTERED WITHOUT THIS INFORMATION)

See appendix pages vi-viii for surface material options.

- Choose Door Style: Defaults to case finish, if none selected
- Choose Pull Style: Defaults to Push Latch, if none selected
- Choose Metal Finish
- Choose Glass Finish
- Choose Paint Finish, if specified
- Choose Veneer Finish, if specified

GENERAL INFORMATION

- Glass is 1/4" -thick back-painted, low-iron glass
- When veneer case is specified, the case exterior is standard slip-match layout regardless of veneer door style selection
- Pull-Out Waste/Recycling Bin size: 17-7/8" x 8-3/32" x 11-9/16"; (1) 35 Qt.; Double Pull-Out Waste/Recycling Units include two bins
- When lock option is specified, color will default based on leg finish:
 - Aged Bronze, Black, Galaxy, Shadow, and Storm: Black
 - Cloud: White
 - Burnish, Foil, and Satin Bronze: Satin Nickel
 - Chrome: Polished Nickel
- Credenzas include one adjustable shelf behind each door unless other components are specified
- Equipment racks hold 12RU and include a thermostatically controlled fan and plug strip



SATIN GLASS TOP

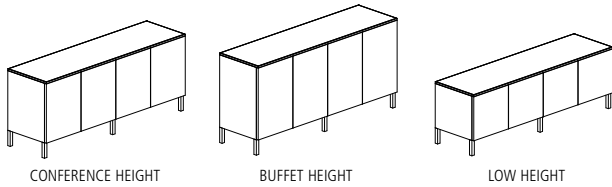

CASE MATERIAL KEY

PA-OB Painted Case with Edge-mount Post Leg
 V-OB Veneer Case with Edge-mount Post Leg

EDGE-MOUNT POST LEG

MODEL #	W x D x H	DESCRIPTION	-PA-OB	-V-OB
CONFERENCE HEIGHT (23.5 IN. CASE WITH 6.5 IN. EDGE-MOUNT POST LEG)				
FWLC-3629-SG	36 x 20 x 30	Two Door	6,562	7,224
FWLC-5429-SG	54 x 20 x 30	Three Door	8,401	9,261
FWLC-7229-SG	72 x 20 x 30	Four Door	10,240	11,301
FWLC-9029-SG	90 x 20 x 30	Five Door	12,082	13,345
FWLD-3629-SG	36 x 24 x 30	Two Door	7,173	7,900
FWLD-5429-SG	54 x 24 x 30	Three Door	9,193	10,141
FWLD-7229-SG	72 x 24 x 30	Four Door	11,220	12,388
FWLD-9029-SG	90 x 24 x 30	Five Door	13,245	14,633
BUFFET HEIGHT (28.5 IN. CASE WITH 6.5 IN. EDGE-MOUNT POST LEG)				
FWCC-3636-SG	36 x 20 x 35	Two Door	7,050	7,765
FWCC-5436-SG	54 x 20 x 35	Three Door	9,035	9,967
FWCC-7236-SG	72 x 20 x 35	Four Door	11,024	12,171
FWCC-9036-SG	90 x 20 x 35	Five Door	13,012	14,376
FWCD-3636-SG	36 x 24 x 35	Two Door	7,707	8,493
FWCD-5436-SG	54 x 24 x 35	Three Door	9,892	10,918
FWCD-7236-SG	72 x 24 x 35	Four Door	12,081	13,341
FWCD-9036-SG	90 x 24 x 35	Five Door	14,267	15,764
LOW HEIGHT (17.5 IN. CASE WITH 6.5 IN. EDGE-MOUNT POST LEG)				
FWWC-3624-SG	36 x 20 x 24	Two Door	6,065	6,670
FWWC-5424-SG	54 x 20 x 24	Three Door	7,755	8,542
FWWC-7224-SG	72 x 20 x 24	Four Door	9,443	10,954
FWWC-9024-SG	90 x 20 x 24	Five Door	11,131	12,290

DOOR STYLE

DESCRIPTION	CODE	NOTES	PRICE
Vertical Veneer	-VD		No Charge
Horizontal Veneer	-HD		No Charge
Veneer/Paint Combination	-VPD	Reference page 8 for predetermined accent door locations	No Charge
Painted	-PAD		No Charge

PULL STYLE

DESCRIPTION	CODE	NOTES	TWO DOOR	THREE DOOR	FOUR DOOR	FIVE DOOR
Push Latch	No Code	Push to open (no pull). Applied to all doors.	No Charge	No Charge	No Charge	No Charge
Handle Pull - Powder Coat	-HP	Pull to open. Applied to all doors.	\$157	\$236	\$314	\$392
Handle Pull - High Polish Finish	-HP-HPF	Pull to open. Applied to all doors.	\$277	\$416	\$554	\$693
Handle Pull - Clear Anodized	-HP-CA	Pull to open. Applied to all doors.	\$157	\$236	\$314	\$392
Handle Pull - Goldmatt Anodized	-HP-GMA	Pull to open. Applied to all doors.	\$230	\$345	\$460	\$575
Handle Pull - Antique Brass Anodized	-HP-ABA	Pull to open. Applied to all doors.	\$230	\$345	\$460	\$575
Handle Pull - Light Bronze Anodized	-HP-LBA	Pull to open. Applied to all doors.	\$230	\$345	\$460	\$575



SATIN GLASS TOP

PUSH LATCH OR HANDLE PULL OPTIONS	CODE	PRICE	NOTES
Locks	Add -LK	\$315	Locks included in all cabinets
Polished Chrome Base	Add -PCOB	\$541	
Wire Frame Pull-Out Waste/Recycling Unit Conference and Buffet Height Credenzas (excludes 36" width)			
(1) 20" Depth Single Wire Frame Unit	Add -TF1	\$309	Located in the rightmost cabinet, behind the right door
(1) 24" Depth Double Wire Frame Unit	Add -TF2	\$477	Located in the rightmost cabinet, behind the right door
Dual Wire Frame Pull-Out Waste/Recycling Units Conference and Buffet Height Credenzas (Excludes 36"-54" width)			
(2) 20" Depth Single Wire Frame Units	Add -TF3	\$617	Located in the rightmost cabinet, behind left and right doors
(2) 24" Depth Double Wire Frame Units	Add -TF4	\$954	Located in the rightmost cabinet, behind left and right doors
24" Depth Equipment Rack Options Available on Buffet Height Credenzas			
Fixed Equipment Rack	Add -R2	\$947	Located in left most cabinet, behind left and right doors
Sliding Equipment Rack	Add -R1	\$3,467	Located in left most cabinet, behind left and right doors

ADDITIONAL HANDLE PULL OPTIONS

Wood Frame Pull-Out Waste/Recycling Bin Unit Conference and Buffet Height Credenzas (Excludes 36" width)			
(1) 20" Depth Single Wood Frame Unit	Add -FWTF1	\$817	Located in the rightmost cabinet, applied to right door
(1) 24" Depth Double Wood Frame Unit	Add -FWTF2	\$1,225	Located in the rightmost cabinet, applied to right door
Dual Wood Frame Pull-Out Waste/Recycling Bin Unit Conference and Buffet Height Credenzas (Excludes 36"-54" width)			
(2) 20" Depth Single Wood Frame Units	Add -FWTF3	\$1,633	Located in the rightmost cabinet, applied to left and right doors
(2) 24" Depth Double Wood Frame Units	Add -FWTF4	\$2,450	Located in the rightmost cabinet, applied to left and right doors
24" Depth Single Pull-Out Drawer Refrigerator Available on Conference and Buffet Height Credenzas			
Pull-Out Drawer Refrigerator	Add -FWOM24	\$7,327	Located in left most cabinet, includes applied door panel

EDGE PROFILE



Glass Top Edge

REQUIRED INFORMATION (ORDER CANNOT BE ENTERED WITHOUT THIS INFORMATION)

See appendix pages vi-viii for surface material options.

- Choose Door Style: Defaults to case finish, if none selected
- Choose Pull Style: Defaults to Push Latch, if none selected
- Choose Metal Finish
- Choose Glass Finish
- Choose Paint Finish, if specified
- Choose Veneer Finish, if specified

GENERAL INFORMATION

- Glass is 1/4"-thick back-painted, low-iron glass
- When veneer case is specified, the case exterior is standard slip-match layout regardless of veneer door style selection
- Pull-Out Waste/Recycling Bin size: 17-7/8" x 8-3/32" x 11-9/16"; (1) 35 Qt.; Double Pull-Out Waste/Recycling Units include two bins
- When lock option is specified, color will default based on leg finish:
 - Aged Bronze, Black, Galaxy, Shadow, and Storm: Black
 - Cloud: White
 - Burnish, Foil, and Satin Bronze: Satin Nickel
 - Chrome: Polished Nickel
- Credenzas include one adjustable shelf behind each door unless other components are specified
- Equipment racks hold 12RU and include a thermostatically controlled fan and plug strip



SATIN GLASS TOP

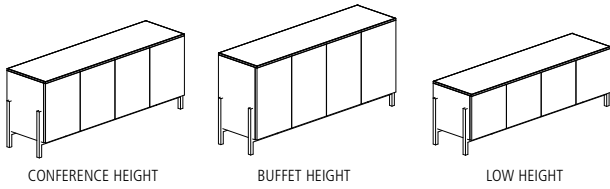

CASE MATERIAL KEY

PA-CB Painted Case with Cradle Base
 V-CB Veneer Case with Cradle Base

CRADLE BASE

MODEL #	W x D x H	DESCRIPTION	-PA-CB	-V-CB
CONFERENCE HEIGHT (23.5 IN. CASE WITH 6.5 IN. CRADLE BASE)				
FWLC-3629-SG	36 x 20 x 30	Two Doors	7,184	7,845
FWLC-5429-SG	54 x 20 x 30	Three Doors	9,019	9,881
FWLC-7229-SG	72 x 20 x 30	Four Doors	10,859	11,922
FWLC-9029-SG	90 x 20 x 30	Five Doors	12,704	13,963
FWLD-3629-SG	36 x 24 x 30	Two Doors	7,792	8,519
FWLD-5429-SG	54 x 24 x 30	Three Doors	9,815	10,764
FWLD-7229-SG	72 x 24 x 30	Four Doors	11,840	13,008
FWLD-9029-SG	90 x 24 x 30	Five Doors	13,867	15,255
BUFFET HEIGHT (28.5 IN. CASE WITH 6.5 IN. CRADLE BASE)				
FWCC-3636-SG	36 x 20 x 35	Two Doors	7,669	8,386
FWCC-5436-SG	54 x 20 x 35	Three Doors	9,656	10,587
FWCC-7236-SG	72 x 20 x 35	Four Doors	11,646	12,790
FWCC-9036-SG	90 x 20 x 35	Five Doors	13,633	14,996
FWCD-3636-SG	36 x 24 x 35	Two Doors	8,327	9,115
FWCD-5436-SG	54 x 24 x 35	Three Doors	10,511	11,536
FWCD-7236-SG	72 x 24 x 35	Four Doors	12,699	13,961
FWCD-9036-SG	90 x 24 x 35	Five Doors	14,888	16,388
LOW HEIGHT (17.5 IN. CASE WITH 6.5 IN. CRADLE BASE)				
FWWC-3624-SG	36 x 20 x 24	Two Doors	6,682	7,291
FWWC-5424-SG	54 x 20 x 24	Three Doors	8,373	9,162
FWWC-7224-SG	72 x 20 x 24	Four Doors	10,063	11,573
FWWC-9024-SG	90 x 20 x 24	Five Doors	11,752	12,910

DOOR STYLE

DESCRIPTION	CODE	NOTES	PRICE
Vertical Veneer	-VD		No Charge
Horizontal Veneer	-HD		No Charge
Veneer/Paint Combination	-VPD	Reference page 8 for predetermined accent door locations	No Charge
Painted	-PAD		No Charge

PULL STYLE

DESCRIPTION	CODE	NOTES	TWO DOOR	THREE DOOR	FOUR DOOR	FIVE DOOR
Push Latch	No Code	Push to open (no pull). Applied to all doors.	No Charge	No Charge	No Charge	No Charge
Handle Pull - Powder Coat	-HP	Pull to open. Applied to all doors.	\$157	\$236	\$314	\$392
Handle Pull - High Polish Finish	-HP-HPF	Pull to open. Applied to all doors.	\$277	\$416	\$554	\$693
Handle Pull - Clear Anodized	-HP-CA	Pull to open. Applied to all doors.	\$157	\$236	\$314	\$392
Handle Pull - Goldmatt Anodized	-HP-GMA	Pull to open. Applied to all doors.	\$230	\$345	\$460	\$575
Handle Pull - Antique Brass Anodized	-HP-ABA	Pull to open. Applied to all doors.	\$230	\$345	\$460	\$575
Handle Pull - Light Bronze Anodized	-HP-LBA	Pull to open. Applied to all doors.	\$230	\$345	\$460	\$575



SATIN GLASS TOP

PUSH LATCH OR HANDLE PULL OPTIONS	CODE	PRICE	NOTES
Locks	Add -LK	\$315	Locks included in all cabinets
Polished Chrome Base	Add -PCCB	\$1,775	
Wire Frame Pull-Out Waste/Recycling Unit Conference and Buffet Height Credenzas (excludes 36" width)			
(1) 20" Depth Single Wire Frame Unit	Add -TF1	\$309	Located in the rightmost cabinet, behind the right door
(1) 24" Depth Double Wire Frame Unit	Add -TF2	\$477	Located in the rightmost cabinet, behind the right door
Dual Wire Frame Pull-Out Waste/Recycling Units Conference and Buffet Height Credenzas (Excludes 36"-54" width)			
(2) 20" Depth Single Wire Frame Units	Add -TF3	\$617	Located in the rightmost cabinet, behind left and right doors
(2) 24" Depth Double Wire Frame Units	Add -TF4	\$954	Located in the rightmost cabinet, behind left and right doors
24" Depth Equipment Rack Options Available on Buffet Height Credenzas			
Fixed Equipment Rack	Add -R2	\$947	Located in left most cabinet, behind left and right doors
Sliding Equipment Rack	Add -R1	\$3,467	Located in left most cabinet, behind left and right doors

ADDITIONAL HANDLE PULL OPTIONS

Wood Frame Pull-Out Waste/Recycling Bin Unit Conference and Buffet Height Credenzas (Excludes 36" width)			
(1) 20" Depth Single Wood Frame Unit	Add -FWTF1	\$817	Located in the rightmost cabinet, applied to right door
(1) 24" Depth Double Wood Frame Unit	Add -FWTF2	\$1,225	Located in the rightmost cabinet, applied to right door
Dual Wood Frame Pull-Out Waste/Recycling Bin Unit Conference and Buffet Height Credenzas (Excludes 36"-54" width)			
(2) 20" Depth Single Wood Frame Units	Add -FWTF3	\$1,633	Located in the rightmost cabinet, applied to left and right doors
(2) 24" Depth Double Wood Frame Units	Add -FWTF4	\$2,450	Located in the rightmost cabinet, applied to left and right doors
24" Depth Single Pull-Out Drawer Refrigerator Available on Conference and Buffet Height Credenzas			
Pull-Out Drawer Refrigerator	Add -FWOM24	\$7,327	Located in left most cabinet, includes applied door panel

EDGE PROFILE



Glass Top Edge

REQUIRED INFORMATION (ORDER CANNOT BE ENTERED WITHOUT THIS INFORMATION)

See appendix pages vi-viii for surface material options.

- Choose Door Style: Defaults to case finish, if none selected
- Choose Pull Style: Defaults to Push Latch, if none selected
- Choose Metal Finish
- Choose Glass Finish
- Choose Paint Finish, if specified
- Choose Veneer Finish, if specified

GENERAL INFORMATION

- Glass is 1/4"-thick back-painted, low-iron glass
- When veneer case is specified, the case exterior is standard slip-match layout regardless of veneer door style selection
- Pull-Out Waste/Recycling Bin size: 17-7/8" x 8-3/32" x 11-9/16"; (1) 35 Qt.; Double Pull-Out Waste/Recycling Units include two bins
- When lock option is specified, color will default based on leg finish:
 - Aged Bronze, Black, Galaxy, Shadow, and Storm: Black
 - Cloud: White
 - Burnish, Foil, and Satin Bronze: Satin Nickel
 - Chrome: Polished Nickel
- Credenzas include one adjustable shelf behind each door unless other components are specified
- Equipment racks hold 12RU and include a thermostatically controlled fan and plug strip



SATIN GLASS TOP

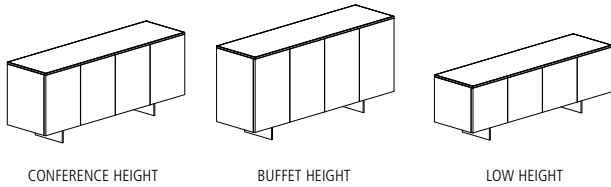

CASE MATERIAL KEY

PA-BB Painted Case with Blade Base
 V-BB Veneer Case with Blade Base

BLADE BASE

MODEL #	W x D x H	DESCRIPTION	-PA-BB	-V-BB
CONFERENCE HEIGHT (23.5 IN. CASE WITH 6 IN. BLADE BASE)				
FWLC-3629-SG	36 x 20 x 29.5	Two Doors	6,872	7,535
FWLC-5429-SG	54 x 20 x 29.5	Three Doors	8,711	9,574
FWLC-7229-SG	72 x 20 x 29.5	Four Doors	10,550	11,610
FWLC-9029-SG	90 x 20 x 29.5	Five Doors	12,393	13,652
FWLD-3629-SG	36 x 24 x 29.5	Two Doors	7,483	8,210
FWLD-5429-SG	54 x 24 x 29.5	Three Doors	9,503	10,454
FWLD-7229-SG	72 x 24 x 29.5	Four Doors	11,530	12,698
FWLD-9029-SG	90 x 24 x 29.5	Five Doors	13,555	14,944
BUFFET HEIGHT (28.5 IN. CASE WITH 6 IN. BLADE BASE)				
FWCC-3636-SG	36 x 20 x 34.5	Two Doors	7,360	8,074
FWCC-5436-SG	54 x 20 x 34.5	Three Doors	9,344	10,279
FWCC-7236-SG	72 x 20 x 34.5	Four Doors	11,336	12,481
FWCC-9036-SG	90 x 20 x 34.5	Five Doors	13,323	14,685
FWCD-3636-SG	36 x 24 x 34.5	Two Doors	8,019	8,803
FWCD-5436-SG	54 x 24 x 34.5	Three Doors	10,203	11,227
FWCD-7236-SG	72 x 24 x 34.5	Four Doors	12,389	13,650
FWCD-9036-SG	90 x 24 x 34.5	Five Doors	14,578	16,075
LOW HEIGHT (17.5 IN. CASE WITH 6 IN. BLADE BASE)				
FWWC-3624-SG	36 x 20 x 23.5	Two Doors	6,375	6,979
FWWC-5424-SG	54 x 20 x 23.5	Three Doors	8,063	8,853
FWWC-7224-SG	72 x 20 x 23.5	Four Doors	9,752	11,264
FWWC-9024-SG	90 x 20 x 23.5	Five Doors	11,441	12,602

DOOR STYLE

DESCRIPTION	CODE	NOTES	PRICE
Vertical Veneer	-VD		No Charge
Horizontal Veneer	-HD		No Charge
Veneer/Paint Combination	-VPD	Reference page 8 for predetermined accent door locations	No Charge
Painted	-PAD		No Charge

PULL STYLE

DESCRIPTION	CODE	NOTES	TWO DOOR	THREE DOOR	FOUR DOOR	FIVE DOOR
Push Latch	No Code	Push to open (no pull). Applied to all doors.	No Charge	No Charge	No Charge	No Charge
Handle Pull - Powder Coat	-HP	Pull to open. Applied to all doors.	\$157	\$236	\$314	\$392
Handle Pull - High Polish Finish	-HP-HPF	Pull to open. Applied to all doors.	\$277	\$416	\$554	\$693
Handle Pull - Clear Anodized	-HP-CA	Pull to open. Applied to all doors.	\$157	\$236	\$314	\$392
Handle Pull - Goldmatt Anodized	-HP-GMA	Pull to open. Applied to all doors.	\$230	\$345	\$460	\$575
Handle Pull - Antique Brass Anodized	-HP-ABA	Pull to open. Applied to all doors.	\$230	\$345	\$460	\$575
Handle Pull - Light Bronze Anodized	-HP-LBA	Pull to open. Applied to all doors.	\$230	\$345	\$460	\$575



SATIN GLASS TOP

PUSH LATCH OR HANDLE PULL OPTIONS	CODE	PRICE	NOTES
Locks	Add -LK	\$315	Locks included in all cabinets
Polished Chrome Base	Add -PCBB	\$501	
Wire Frame Pull-Out Waste/Recycling Unit Conference and Buffet Height Credenzas (excludes 36" width)			
(1) 20" Depth Single Wire Frame Unit	Add -TF1	\$309	Located in the rightmost cabinet, behind the right door
(1) 24" Depth Double Wire Frame Unit	Add -TF2	\$477	Located in the rightmost cabinet, behind the right door
Dual Wire Frame Pull-Out Waste/Recycling Units Conference and Buffet Height Credenzas (Excludes 36"-54" width)			
(2) 20" Depth Single Wire Frame Units	Add -TF3	\$617	Located in the rightmost cabinet, behind left and right doors
(2) 24" Depth Double Wire Frame Units	Add -TF4	\$954	Located in the rightmost cabinet, behind left and right doors
24" Depth Equipment Rack Options Available on Buffet Height Credenzas			
Fixed Equipment Rack	Add -R2	\$947	Located in left most cabinet, behind left and right doors
Sliding Equipment Rack	Add -R1	\$3,467	Located in left most cabinet, behind left and right doors

ADDITIONAL HANDLE PULL OPTIONS

Wood Frame Pull-Out Waste/Recycling Bin Unit Conference and Buffet Height Credenzas (Excludes 36" width)			
(1) 20" Depth Single Wood Frame Unit	Add -FWTF1	\$817	Located in the rightmost cabinet, applied to right door
(1) 24" Depth Double Wood Frame Unit	Add -FWTF2	\$1,225	Located in the rightmost cabinet, applied to right door
Dual Wood Frame Pull-Out Waste/Recycling Bin Unit Conference and Buffet Height Credenzas (Excludes 36"-54" width)			
(2) 20" Depth Single Wood Frame Units	Add -FWTF3	\$1,633	Located in the rightmost cabinet, applied to left and right doors
(2) 24" Depth Double Wood Frame Units	Add -FWTF4	\$2,450	Located in the rightmost cabinet, applied to left and right doors
24" Depth Single Pull-Out Drawer Refrigerator Available on Conference and Buffet Height Credenzas			
Pull-Out Drawer Refrigerator	Add -FWOM24	\$7,327	Located in left most cabinet, includes applied door panel

EDGE PROFILE



Glass Top Edge

REQUIRED INFORMATION (ORDER CANNOT BE ENTERED WITHOUT THIS INFORMATION)

See appendix pages vi-viii for surface material options.

- Choose Door Style: Defaults to case finish, if none selected
- Choose Pull Style: Defaults to Push Latch, if none selected
- Choose Metal Finish
- Choose Glass Finish
- Choose Paint Finish, if specified
- Choose Veneer Finish, if specified

GENERAL INFORMATION

- Glass is 1/4"-thick back-painted, low-iron glass
- When veneer case is specified, the case exterior is standard slip-match layout regardless of veneer door style selection
- Pull-Out Waste/Recycling Bin size: 17-7/8" x 8-3/32" x 11-9/16"; (1) 35 Qt.; Double Pull-Out Waste/Recycling Units include two bins
- When lock option is specified, color will default based on leg finish:
 - Aged Bronze, Black, Galaxy, Shadow, and Storm: Black
 - Cloud: White
 - Burnish, Foil, and Satin Bronze: Satin Nickel
 - Chrome: Polished Nickel
- Credenzas include one adjustable shelf behind each door unless other components are specified
- Equipment racks hold 12RU and include a thermostatically controlled fan and plug strip



STONE/QUARTZ TOP WITH SQUARE EDGE

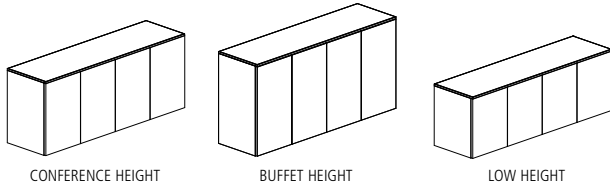

CASE MATERIAL KEY

PA Painted Case
V Veneer Case

CASE ONLY

MODEL #	W x D x H	DESCRIPTION	-PA	-V
CONFERENCE HEIGHT (29.5 INCH CASE)				
FWCC-3629-S	36 x 20 x 29.5	Two Doors	7,347	8,160
FWCC-5429-S	54 x 20 x 29.5	Three Doors	9,561	10,620
FWCC-7229-S	72 x 20 x 29.5	Four Doors	11,781	13,088
FWCC-9029-S	90 x 20 x 29.5	Five Doors	14,000	15,552
FWCD-3629-S	36 x 24 x 29.5	Two Doors	8,080	8,977
FWCD-5429-S	54 x 24 x 29.5	Three Doors	10,519	11,688
FWCD-7229-S	72 x 24 x 29.5	Four Doors	12,958	14,395
FWCD-9029-S	90 x 24 x 29.5	Five Doors	15,398	17,106
BUFFET HEIGHT (36.5 INCH CASE)				
FWBC-3636-S	36 x 20 x 36.5	Two Doors	8,447	9,379
FWBC-5436-S	54 x 20 x 36.5	Three Doors	10,993	12,211
FWBC-7236-S	72 x 20 x 36.5	Four Doors	13,546	15,050
FWBC-9036-S	90 x 20 x 36.5	Five Doors	16,096	17,881
FWBD-3636-S	36 x 24 x 36.5	Two Doors	9,291	10,317
FWBD-5436-S	54 x 24 x 36.5	Three Doors	12,091	13,434
FWBD-7236-S	72 x 24 x 36.5	Four Doors	14,899	16,553
FWBD-9036-S	90 x 24 x 36.5	Five Doors	17,704	19,669
LOW HEIGHT (24.5 INCH CASE)				
FWLC-3624-S	36 x 20 x 24.5	Two Doors	6,802	7,558
FWLC-5424-S	54 x 20 x 24.5	Three Doors	8,854	9,836
FWLC-7224-S	72 x 20 x 24.5	Four Doors	10,907	12,120
FWLC-9024-S	90 x 20 x 24.5	Five Doors	12,964	14,400
FWLD-3624-S	36 x 24 x 24.5	Two Doors	7,483	8,313
FWLD-5424-S	54 x 24 x 24.5	Three Doors	9,740	10,820
FWLD-7224-S	72 x 24 x 24.5	Four Doors	11,998	13,332
FWLD-9024-S	90 x 24 x 24.5	Five Doors	14,256	15,841

DOOR STYLE

DESCRIPTION	CODE	NOTES	PRICE
Vertical Veneer	-VD		No Charge
Horizontal Veneer	-HD		No Charge
Veneer/Paint Combination	-VPD	Reference page 8 for predetermined accent door locations	No Charge
Painted	-PAD		No Charge

PULL STYLE

DESCRIPTION	CODE	NOTES	TWO DOOR	THREE DOOR	FOUR DOOR	FIVE DOOR
Push Latch	No Code	Push to open (no pull). Applied to all doors.	No Charge	No Charge	No Charge	No Charge
Handle Pull - Powder Coat	-HP	Pull to open. Applied to all doors.	\$157	\$236	\$314	\$392
Handle Pull - High Polish Finish	-HP-HPF	Pull to open. Applied to all doors.	\$277	\$416	\$554	\$693
Handle Pull - Clear Anodized	-HP-CA	Pull to open. Applied to all doors.	\$157	\$236	\$314	\$392
Handle Pull - Goldmatt Anodized	-HP-GMA	Pull to open. Applied to all doors.	\$230	\$345	\$460	\$575
Handle Pull - Antique Brass Anodized	-HP-ABA	Pull to open. Applied to all doors.	\$230	\$345	\$460	\$575
Handle Pull - Light Bronze Anodized	-HP-LBA	Pull to open. Applied to all doors.	\$230	\$345	\$460	\$575



STONE/QUARTZ TOP WITH SQUARE EDGE

PUSH LATCH OR HANDLE PULL OPTIONS	CODE	PRICE	NOTES
Locks	Add -LK	\$315	Locks included in all cabinets
Drawers Behind Doors	Add -D	\$614	Available on Buffet Height Credenza
Wire Frame Pull-Out Waste/Recycling Unit Conference, Buffet, and Low Height Credenzas (excludes 36" width)			
(1) 20" Depth Single Wire Frame Unit	Add -TF1	\$309	Located in the rightmost cabinet, behind the right door
(1) 24" Depth Double Wire Frame Unit	Add -TF2	\$477	Located in the rightmost cabinet, behind the right door
Dual Wire Frame Pull-Out Waste/Recycling Units Conference, Buffet, and Low Height Credenzas (Excludes 36"-54" width)			
(2) 20" Depth Single Wire Frame Units	Add -TF3	\$617	Located in the rightmost cabinet, behind left and right doors
(2) 24" Depth Double Wire Frame Units	Add -TF4	\$954	Located in the rightmost cabinet, behind left and right doors
24" Depth Equipment Rack Options Available on Conference and Buffet Height Credenzas			
Fixed Equipment Rack	Add -R2	\$947	Located in left most cabinet, behind left and right doors
Sliding Equipment Rack	Add -R1	\$3,467	Located in left most cabinet, behind left and right doors

ADDITIONAL HANDLE PULL OPTIONS

Wood Frame Pull-Out Waste/Recycling Bin Unit Conference, Buffet, and Low Height Credenzas (Excludes 36" width)			
(1) 20" Depth Single Wood Frame Unit	Add -FWTF1	\$817	Located in the rightmost cabinet, applied to right door
(1) 24" Depth Double Wood Frame Unit	Add -FWTF2	\$1,225	Located in the rightmost cabinet, applied to right door
Dual Wood Frame Pull-Out Waste/Recycling Bin Unit Conference, Buffet, and Low Height Credenzas (Excludes 36"-54" width)			
(2) 20" Depth Single Wood Frame Units	Add -FWTF3	\$1,633	Located in the rightmost cabinet, applied to left and right doors
(2) 24" Depth Double Wood Frame Units	Add -FWTF4	\$2,450	Located in the rightmost cabinet, applied to left and right doors
24" Depth Single Pull-Out Drawer Refrigerator Available on Conference and Low Height Credenzas			
Pull-Out Drawer Refrigerator	Add -FWOM24	\$7,327	Located in left most cabinet, includes applied door panel

EDGE PROFILE



Square Edge

REQUIRED INFORMATION (ORDER CANNOT BE ENTERED WITHOUT THIS INFORMATION)

See appendix pages vi-viii for surface material options.

- Choose Door Style: Defaults to case finish, if none selected
- Choose Pull Style: Defaults to Push Latch, if none selected
- Choose Stone/Quartz Finish
- Choose Paint Finish, if specified
- Choose Veneer Finish, if specified

GENERAL INFORMATION

- Stone/Quartz tops are 2cm thick
- When veneer case is specified, the case exterior is standard slip-match layup regardless of veneer door style selection
- Pull-Out Waste/Recycling Bin size: 17-7/8" x 8-3/32" x 11-9/16"; (1) 35 Qt.; Double Pull-Out Waste/Recycling Units include two bins
- Locks
 - Veneer (Case Only) - When lock option is specified, color will default to Satin Nickel
 - Painted (Case Only) - When lock option is specified, color will default based on Paint finish:
 - Aged Bronze, Black, Galaxy, Shadow, and Storm: Black
 - Cloud: White
 - Burnish, Foil, Satin Bronze: Satin Nickel
 - Chrome: Polished Nickel
- Credenzas include one adjustable shelf behind each door unless other components are specified
- Equipment racks hold 12RU and include a thermostatically controlled fan and plug strip



STONE/QUARTZ TOP WITH SQUARE EDGE

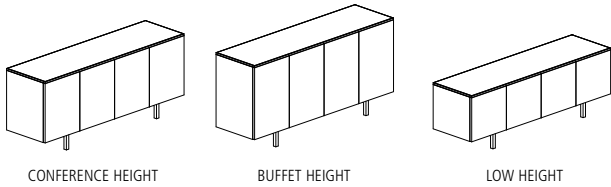

CASE MATERIAL KEY

PA-IB Painted Case with Inset Leg
 V-IB Veneer Case with Inset Leg

INSET LEG

MODEL #	W x D x H	DESCRIPTION	-PA-IB	-V-IB
CONFERENCE HEIGHT (24 IN. CASE WITH 6.5 IN. INSET LEG)				
FWLC-3629-S	36 x 20 x 30.5	Two Doors	7,265	8,022
FWLC-5429-S	54 x 20 x 30.5	Three Doors	9,320	10,302
FWLC-7229-S	72 x 20 x 30.5	Four Doors	11,373	12,583
FWLC-9029-S	90 x 20 x 30.5	Five Doors	13,427	14,866
FWLD-3629-S	36 x 24 x 30.5	Two Doors	7,946	8,778
FWLD-5429-S	54 x 24 x 30.5	Three Doors	10,204	11,286
FWLD-7229-S	72 x 24 x 30.5	Four Doors	12,462	13,797
FWLD-9029-S	90 x 24 x 30.5	Five Doors	14,722	16,307
BUFFET HEIGHT (29 IN. CASE WITH 6.5 IN. INSET LEG)				
FWCC-3636-S	36 x 20 x 35.5	Two Doors	7,811	8,626
FWCC-5436-S	54 x 20 x 35.5	Three Doors	10,028	11,088
FWCC-7236-S	72 x 20 x 35.5	Four Doors	12,246	13,553
FWCC-9036-S	90 x 20 x 35.5	Five Doors	14,464	16,017
FWCD-3636-S	36 x 24 x 35.5	Two Doors	8,543	9,443
FWCD-5436-S	54 x 24 x 35.5	Three Doors	10,984	12,150
FWCD-7236-S	72 x 24 x 35.5	Four Doors	13,420	14,860
FWCD-9036-S	90 x 24 x 35.5	Five Doors	15,864	17,572
LOW HEIGHT (18 IN. CASE WITH 6.5 IN. INSET LEG)				
FWWC-3624-S	36 x 20 x 24.5	Two Doors	6,708	7,403
FWWC-5424-S	54 x 20 x 24.5	Three Doors	8,599	9,499
FWWC-7224-S	72 x 20 x 24.5	Four Doors	10,478	11,591
FWWC-9024-S	90 x 20 x 24.5	Five Doors	12,365	13,685

DOOR STYLE

DESCRIPTION	CODE	NOTES	PRICE
Vertical Veneer	-VD		No Charge
Horizontal Veneer	-HD		No Charge
Veneer/Paint Combination	-VPD	Reference page 8 for predetermined accent door locations	No Charge
Painted	-PAD		No Charge

PULL STYLE

DESCRIPTION	CODE	NOTES	TWO DOOR	THREE DOOR	FOUR DOOR	FIVE DOOR
Push Latch	No Code	Push to open (no pull). Applied to all doors.	No Charge	No Charge	No Charge	No Charge
Handle Pull - Powder Coat	-HP	Pull to open. Applied to all doors.	\$157	\$236	\$314	\$392
Handle Pull - High Polish Finish	-HP-HPF	Pull to open. Applied to all doors.	\$277	\$416	\$554	\$693
Handle Pull - Clear Anodized	-HP-CA	Pull to open. Applied to all doors.	\$157	\$236	\$314	\$392
Handle Pull - Goldmatt Anodized	-HP-GMA	Pull to open. Applied to all doors.	\$230	\$345	\$460	\$575
Handle Pull - Antique Brass Anodized	-HP-ABA	Pull to open. Applied to all doors.	\$230	\$345	\$460	\$575
Handle Pull - Light Bronze Anodized	-HP-LBA	Pull to open. Applied to all doors.	\$230	\$345	\$460	\$575



STONE/QUARTZ TOP WITH SQUARE EDGE

PUSH LATCH OR HANDLE PULL OPTIONS	CODE	PRICE	NOTES
Locks	Add -LK	\$315	Locks included in all cabinets
Polished Chrome Base	Add -PCIB	\$501	
Wire Frame Pull-Out Waste/Recycling Unit Conference and Buffet Height Credenzas (excludes 36" width)			
(1) 20" Depth Single Wire Frame Unit	Add -TF1	\$309	Located in the rightmost cabinet, behind the right door
(1) 24" Depth Double Wire Frame Unit	Add -TF2	\$477	Located in the rightmost cabinet, behind the right door
Dual Wire Frame Pull-Out Waste/Recycling Units Conference and Buffet Height Credenzas (Excludes 36"-54" width)			
(2) 20" Depth Single Wire Frame Units	Add -TF3	\$617	Located in the rightmost cabinet, behind left and right doors
(2) 24" Depth Double Wire Frame Units	Add -TF4	\$954	Located in the rightmost cabinet, behind left and right doors
24" Depth Equipment Rack Options Available on Buffet Height Credenzas			
Fixed Equipment Rack	Add -R2	\$947	Located in left most cabinet, behind left and right doors
Sliding Equipment Rack	Add -R1	\$3,467	Located in left most cabinet, behind left and right doors

ADDITIONAL HANDLE PULL OPTIONS

Wood Frame Pull-Out Waste/Recycling Bin Unit Conference and Buffet Height Credenzas (Excludes 36" width)			
(1) 20" Depth Single Wood Frame Unit	Add -FWTF1	\$817	Located in the rightmost cabinet, applied to right door
(1) 24" Depth Double Wood Frame Unit	Add -FWTF2	\$1,225	Located in the rightmost cabinet, applied to right door
Dual Wood Frame Pull-Out Waste/Recycling Bin Unit Conference and Buffet Height Credenzas (Excludes 36"-54" width)			
(2) 20" Depth Single Wood Frame Units	Add -FWTF3	\$1,633	Located in the rightmost cabinet, applied to left and right doors
(2) 24" Depth Double Wood Frame Units	Add -FWTF4	\$2,450	Located in the rightmost cabinet, applied to left and right doors
24" Depth Single Pull-Out Drawer Refrigerator Available on Conference and Buffet Height Credenzas			
Pull-Out Drawer Refrigerator	Add -FWOM24	\$7,327	Located in left most cabinet, includes applied door panel

EDGE PROFILE



Square Edge

REQUIRED INFORMATION (ORDER CANNOT BE ENTERED WITHOUT THIS INFORMATION)

See appendix pages vi-viii for surface material options.

- Choose Door Style: Defaults to case finish, if none selected
- Choose Pull Style: Defaults to Push Latch, if none selected
- Choose Metal Finish
- Choose Stone/Quartz Finish
- Choose Paint Finish, if specified
- Choose Veneer Finish, if specified

GENERAL INFORMATION

- Stone/Quartz tops are 2cm thick
- When veneer case is specified, the case exterior is standard slip-match layout regardless of veneer door style selection
- Pull-Out Waste/Recycling Bin size: 17-7/8" x 8-3/32" x 11-9/16"; (1) 35 Qt.; Double Pull-Out Waste/Recycling Units include two bins
- When lock option is specified, color will default based on leg finish:
 - Aged Bronze, Black, Galaxy, Shadow, and Storm: Black
 - Cloud: White
 - Burnish, Foil, and Satin Bronze: Satin Nickel
 - Chrome: Polished Nickel
- Credenzas include one adjustable shelf behind each door unless other components are specified
- Equipment racks hold 12RU and include a thermostatically controlled fan and plug strip



STONE/QUARTZ TOP WITH SQUARE EDGE

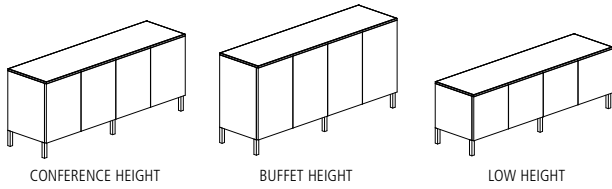

CASE MATERIAL KEY

PA-OB Painted Case with Edge-mount Post Leg
 V-OB Veneer Case with Edge-mount Post Leg

EDGE-MOUNT POST LEG

MODEL #	W x D x H	DESCRIPTION	-PA-OB	-V-OB
CONFERENCE HEIGHT (24 IN. CASE WITH 6.5 IN. EDGE-MOUNT POST LEG)				
FWLC-3629-S	36 x 20 x 30.5	Two Door	7,265	8,022
FWLC-5429-S	54 x 20 x 30.5	Three Door	9,320	10,302
FWLC-7229-S	72 x 20 x 30.5	Four Door	11,373	12,583
FWLC-9029-S	90 x 20 x 30.5	Five Door	13,427	14,866
FWLD-3629-S	36 x 24 x 30.5	Two Door	7,946	8,778
FWLD-5429-S	54 x 24 x 30.5	Three Door	10,204	11,286
FWLD-7229-S	72 x 24 x 30.5	Four Door	12,462	13,797
FWLD-9029-S	90 x 24 x 30.5	Five Door	14,722	16,307
BUFFET HEIGHT (29 IN. CASE WITH 6.5 IN. EDGE-MOUNT POST LEG)				
FWCC-3636-S	36 x 20 x 35.5	Two Door	7,811	8,626
FWCC-5436-S	54 x 20 x 35.5	Three Door	10,028	11,088
FWCC-7236-S	72 x 20 x 35.5	Four Door	12,246	13,553
FWCC-9036-S	90 x 20 x 35.5	Five Door	14,464	16,017
FWCD-3636-S	36 x 24 x 35.5	Two Door	8,543	9,443
FWCD-5436-S	54 x 24 x 35.5	Three Door	10,984	12,150
FWCD-7236-S	72 x 24 x 35.5	Four Door	13,420	14,860
FWCD-9036-S	90 x 24 x 35.5	Five Door	15,864	17,572
LOW HEIGHT (18 IN. CASE WITH 6.5 IN. EDGE-MOUNT POST LEG)				
FWWC-3624-S	36 x 20 x 24.5	Two Door	6,708	7,403
FWWC-5424-S	54 x 20 x 24.5	Three Door	8,599	9,499
FWWC-7224-S	72 x 20 x 24.5	Four Door	10,478	11,591
FWWC-9024-S	90 x 20 x 24.5	Five Door	12,365	13,685

DOOR STYLE

DESCRIPTION	CODE	NOTES	PRICE
Vertical Veneer	-VD		No Charge
Horizontal Veneer	-HD		No Charge
Veneer/Paint Combination	-VPD	Reference page 8 for predetermined accent door locations	No Charge
Painted	-PAD		No Charge

PULL STYLE

DESCRIPTION	CODE	NOTES	TWO DOOR	THREE DOOR	FOUR DOOR	FIVE DOOR
Push Latch	No Code	Push to open (no pull). Applied to all doors.	No Charge	No Charge	No Charge	No Charge
Handle Pull - Powder Coat	-HP	Pull to open. Applied to all doors.	\$157	\$236	\$314	\$392
Handle Pull - High Polish Finish	-HP-HPF	Pull to open. Applied to all doors.	\$277	\$416	\$554	\$693
Handle Pull - Clear Anodized	-HP-CA	Pull to open. Applied to all doors.	\$157	\$236	\$314	\$392
Handle Pull - Goldmatt Anodized	-HP-GMA	Pull to open. Applied to all doors.	\$230	\$345	\$460	\$575
Handle Pull - Antique Brass Anodized	-HP-ABA	Pull to open. Applied to all doors.	\$230	\$345	\$460	\$575
Handle Pull - Light Bronze Anodized	-HP-LBA	Pull to open. Applied to all doors.	\$230	\$345	\$460	\$575



STONE/QUARTZ TOP WITH SQUARE EDGE

PUSH LATCH OR HANDLE PULL OPTIONS	CODE	PRICE	NOTES
Locks	Add -LK	\$315	Locks included in all cabinets
Polished Chrome Base	Add -PCOB	\$541	
Wire Frame Pull-Out Waste/Recycling Unit Conference and Buffet Height Credenzas (excludes 36" width)			
(1) 20" Depth Single Wire Frame Unit	Add -TF1	\$309	Located in the rightmost cabinet, behind the right door
(1) 24" Depth Double Wire Frame Unit	Add -TF2	\$477	Located in the rightmost cabinet, behind the right door
Dual Wire Frame Pull-Out Waste/Recycling Units Conference and Buffet Height Credenzas (Excludes 36"-54" width)			
(2) 20" Depth Single Wire Frame Units	Add -TF3	\$617	Located in the rightmost cabinet, behind left and right doors
(2) 24" Depth Double Wire Frame Units	Add -TF4	\$954	Located in the rightmost cabinet, behind left and right doors
24" Depth Equipment Rack Options Available on Buffet Height Credenzas			
Fixed Equipment Rack	Add -R2	\$947	Located in left most cabinet, behind left and right doors
Sliding Equipment Rack	Add -R1	\$3,467	Located in left most cabinet, behind left and right doors

ADDITIONAL HANDLE PULL OPTIONS

Wood Frame Pull-Out Waste/Recycling Bin Unit Conference and Buffet Height Credenzas (Excludes 36" width)			
(1) 20" Depth Single Wood Frame Unit	Add -FWTF1	\$817	Located in the rightmost cabinet, applied to right door
(1) 24" Depth Double Wood Frame Unit	Add -FWTF2	\$1,225	Located in the rightmost cabinet, applied to right door
Dual Wood Frame Pull-Out Waste/Recycling Bin Unit Conference and Buffet Height Credenzas (Excludes 36"-54" width)			
(2) 20" Depth Single Wood Frame Units	Add -FWTF3	\$1,633	Located in the rightmost cabinet, applied to left and right doors
(2) 24" Depth Double Wood Frame Units	Add -FWTF4	\$2,450	Located in the rightmost cabinet, applied to left and right doors
24" Depth Single Pull-Out Drawer Refrigerator Available on Conference and Buffet Height Credenzas			
Pull-Out Drawer Refrigerator	Add -FWOM24	\$7,327	Located in left most cabinet, includes applied door panel

EDGE PROFILE



Square Edge

REQUIRED INFORMATION (ORDER CANNOT BE ENTERED WITHOUT THIS INFORMATION)

See appendix pages vi-viii for surface material options.

- Choose Door Style: Defaults to case finish, if none selected
- Choose Pull Style: Defaults to Push Latch, if none selected
- Choose Metal Finish
- Choose Stone/Quartz Finish
- Choose Paint Finish, if specified
- Choose Veneer Finish, if specified

GENERAL INFORMATION

- Stone/Quartz tops are 2cm thick
- When veneer case is specified, the case exterior is standard slip-match layout regardless of veneer door style selection
- Pull-Out Waste/Recycling Bin size: 17-7/8" x 8-3/32" x 11-9/16"; (1) 35 Qt.; Double Pull-Out Waste/Recycling Units include two bins
- When lock option is specified, color will default based on leg finish:
 - Aged Bronze, Black, Galaxy, Shadow, and Storm: Black
 - Cloud: White
 - Burnish, Foil, and Satin Bronze: Satin Nickel
 - Chrome: Polished Nickel
- Credenzas include one adjustable shelf behind each door unless other components are specified
- Equipment racks hold 12RU and include a thermostatically controlled fan and plug strip



STONE/QUARTZ TOP WITH SQUARE EDGE

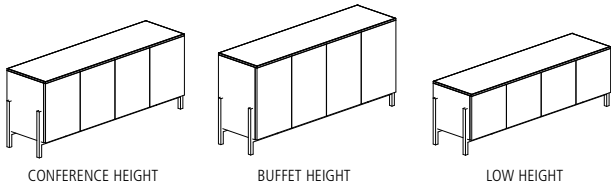

CASE MATERIAL KEY

PA-CB Painted Case with Cradle Base
 V-CB Veneer Case with Cradle Base

CRADLE BASE

MODEL #	W x D x H	DESCRIPTION	-PA-CB	-V-CB
CONFERENCE HEIGHT (24 IN. CASE WITH 6.5 IN. CRADLE BASE)				
FWLC-3629-S	36 x 20 x 30.5	Two Doors	7,888	8,643
FWLC-5429-S	54 x 20 x 30.5	Three Doors	9,942	10,921
FWLC-7229-S	72 x 20 x 30.5	Four Doors	11,993	13,203
FWLC-9029-S	90 x 20 x 30.5	Five Doors	14,047	15,484
FWLD-3629-S	36 x 24 x 30.5	Two Doors	8,569	9,398
FWLD-5429-S	54 x 24 x 30.5	Three Doors	10,824	11,906
FWLD-7229-S	72 x 24 x 30.5	Four Doors	13,084	14,417
FWLD-9029-S	90 x 24 x 30.5	Five Doors	15,343	16,925
BUFFET HEIGHT (29 IN. CASE WITH 6.5 IN. CRADLE BASE)				
FWCC-3636-S	36 x 20 x 35.5	Two Doors	8,431	9,246
FWCC-5436-S	54 x 20 x 35.5	Three Doors	10,647	11,707
FWCC-7236-S	72 x 20 x 35.5	Four Doors	12,865	14,173
FWCC-9036-S	90 x 20 x 35.5	Five Doors	15,083	16,636
FWCD-3636-S	36 x 24 x 35.5	Two Doors	9,164	10,063
FWCD-5436-S	54 x 24 x 35.5	Three Doors	11,601	12,770
FWCD-7236-S	72 x 24 x 35.5	Four Doors	14,043	15,481
FWCD-9036-S	90 x 24 x 35.5	Five Doors	16,483	18,193
LOW HEIGHT (18 IN. CASE WITH 6.5 IN. CRADLE BASE)				
FWWC-3624-S	36 x 20 x 24.5	Two Doors	7,329	8,023
FWWC-5424-S	54 x 20 x 24.5	Three Doors	9,219	10,119
FWWC-7224-S	72 x 20 x 24.5	Four Doors	11,099	12,211
FWWC-9024-S	90 x 20 x 24.5	Five Doors	12,984	14,307

DOOR STYLE

DESCRIPTION	CODE	NOTES	PRICE
Vertical Veneer	-VD		No Charge
Horizontal Veneer	-HD		No Charge
Veneer/Paint Combination	-VPD	Reference page 8 for predetermined accent door locations	No Charge
Painted	-PAD		No Charge

PULL STYLE

DESCRIPTION	CODE	NOTES	TWO DOOR	THREE DOOR	FOUR DOOR	FIVE DOOR
Push Latch	No Code	Push to open (no pull). Applied to all doors.	No Charge	No Charge	No Charge	No Charge
Handle Pull - Powder Coat	-HP	Pull to open. Applied to all doors.	\$157	\$236	\$314	\$392
Handle Pull - High Polish Finish	-HP-HPF	Pull to open. Applied to all doors.	\$277	\$416	\$554	\$693
Handle Pull - Clear Anodized	-HP-CA	Pull to open. Applied to all doors.	\$157	\$236	\$314	\$392
Handle Pull - Goldmatt Anodized	-HP-GMA	Pull to open. Applied to all doors.	\$230	\$345	\$460	\$575
Handle Pull - Antique Brass Anodized	-HP-ABA	Pull to open. Applied to all doors.	\$230	\$345	\$460	\$575
Handle Pull - Light Bronze Anodized	-HP-LBA	Pull to open. Applied to all doors.	\$230	\$345	\$460	\$575



STONE/QUARTZ TOP WITH SQUARE EDGE

PUSH LATCH OR HANDLE PULL OPTIONS	CODE	PRICE	NOTES
Locks	Add -LK	\$315	Locks included in all cabinets
Polished Chrome Base	Add -PCCB	\$1,775	
Wire Frame Pull-Out Waste/Recycling Unit Conference and Buffet Height Credenzas (excludes 36" width)			
(1) 20" Depth Single Wire Frame Unit	Add -TF1	\$309	Located in the rightmost cabinet, behind the right door
(1) 24" Depth Double Wire Frame Unit	Add -TF2	\$477	Located in the rightmost cabinet, behind the right door
Dual Wire Frame Pull-Out Waste/Recycling Units Conference and Buffet Height Credenzas (Excludes 36"-54" width)			
(2) 20" Depth Single Wire Frame Units	Add -TF3	\$617	Located in the rightmost cabinet, behind left and right doors
(2) 24" Depth Double Wire Frame Units	Add -TF4	\$954	Located in the rightmost cabinet, behind left and right doors
24" Depth Equipment Rack Options Available on Buffet Height Credenzas			
Fixed Equipment Rack	Add -R2	\$947	Located in left most cabinet, behind left and right doors
Sliding Equipment Rack	Add -R1	\$3,467	Located in left most cabinet, behind left and right doors

ADDITIONAL HANDLE PULL OPTIONS

Wood Frame Pull-Out Waste/Recycling Bin Unit Conference and Buffet Height Credenzas (Excludes 36" width)			
(1) 20" Depth Single Wood Frame Unit	Add -FWTF1	\$817	Located in the rightmost cabinet, applied to right door
(1) 24" Depth Double Wood Frame Unit	Add -FWTF2	\$1,225	Located in the rightmost cabinet, applied to right door
Dual Wood Frame Pull-Out Waste/Recycling Bin Unit Conference and Buffet Height Credenzas (Excludes 36"-54" width)			
(2) 20" Depth Single Wood Frame Units	Add -FWTF3	\$1,633	Located in the rightmost cabinet, applied to left and right doors
(2) 24" Depth Double Wood Frame Units	Add -FWTF4	\$2,450	Located in the rightmost cabinet, applied to left and right doors
24" Depth Single Pull-Out Drawer Refrigerator Available on Conference and Buffet Height Credenzas			
Pull-Out Drawer Refrigerator	Add -FWOM24	\$7,327	Located in left most cabinet, includes applied door panel

EDGE PROFILE



Square Edge

REQUIRED INFORMATION (ORDER CANNOT BE ENTERED WITHOUT THIS INFORMATION)

See appendix pages vi-viii for surface material options.

- Choose Door Style: Defaults to case finish, if none selected
- Choose Pull Style: Defaults to Push Latch, if none selected
- Choose Metal Finish
- Choose Stone/Quartz Finish
- Choose Paint Finish, if specified
- Choose Veneer Finish, if specified

GENERAL INFORMATION

- Stone/Quartz tops are 2cm thick
- When veneer case is specified, the case exterior is standard slip-match layout regardless of veneer door style selection
- Pull-Out Waste/Recycling Bin size: 17-7/8" x 8-3/32" x 11-9/16"; (1) 35 Qt.; Double Pull-Out Waste/Recycling Units include two bins
- When lock option is specified, color will default based on leg finish:
 - Aged Bronze, Black, Galaxy, Shadow, and Storm: Black
 - Cloud: White
 - Burnish, Foil, and Satin Bronze: Satin Nickel
 - Chrome: Polished Nickel
- Credenzas include one adjustable shelf behind each door unless other components are specified
- Equipment racks hold 12RU and include a thermostatically controlled fan and plug strip



STONE/QUARTZ TOP WITH SQUARE EDGE

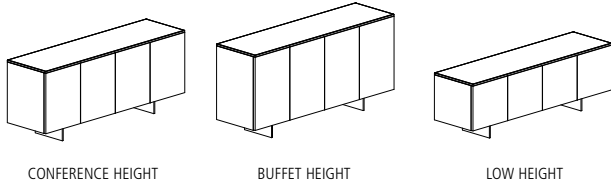

CASE MATERIAL KEY

PA-BB Painted Case with Blade Base
 V-BB Veneer Case with Blade Base

BLADE BASE

MODEL #	W x D x H	DESCRIPTION	-PA-BB	-V-BB
CONFERENCE HEIGHT (24 IN. CASE WITH 6 IN. BLADE BASE)				
FWLC-3629-S	36 x 20 x 30	Two Doors	7,577	8,331
FWLC-5429-S	54 x 20 x 30	Three Doors	9,630	10,610
FWLC-7229-S	72 x 20 x 30	Four Doors	11,683	12,895
FWLC-9029-S	90 x 20 x 30	Five Doors	13,737	15,176
FWLD-3629-S	36 x 24 x 30	Two Doors	8,258	9,087
FWLD-5429-S	54 x 24 x 30	Three Doors	10,517	11,596
FWLD-7229-S	72 x 24 x 30	Four Doors	12,775	14,105
FWLD-9029-S	90 x 24 x 30	Five Doors	15,034	16,615
BUFFET HEIGHT (29 IN. CASE WITH 6 IN. BLADE BASE)				
FWCC-3636-S	36 x 20 x 35	Two Doors	8,122	8,934
FWCC-5436-S	54 x 20 x 35	Three Doors	10,338	11,396
FWCC-7236-S	72 x 20 x 35	Four Doors	12,556	13,866
FWCC-9036-S	90 x 20 x 35	Five Doors	14,775	16,324
FWCD-3636-S	36 x 24 x 35	Two Doors	8,854	9,752
FWCD-5436-S	54 x 24 x 35	Three Doors	11,292	12,460
FWCD-7236-S	72 x 24 x 35	Four Doors	13,734	15,173
FWCD-9036-S	90 x 24 x 35	Five Doors	16,174	17,883
LOW HEIGHT (18 IN. CASE WITH 6 IN. BLADE BASE)				
FWWC-3624-S	36 x 20 x 24	Two Doors	7,020	7,713
FWWC-5424-S	54 x 20 x 24	Three Doors	8,908	9,808
FWWC-7224-S	72 x 20 x 24	Four Doors	10,790	11,903
FWWC-9024-S	90 x 20 x 24	Five Doors	12,675	13,995

DOOR STYLE

DESCRIPTION	CODE	NOTES	PRICE
Vertical Veneer	-VD		No Charge
Horizontal Veneer	-HD		No Charge
Veneer/Paint Combination	-VPD	Reference page 8 for predetermined accent door locations	No Charge
Painted	-PAD		No Charge

PULL STYLE

DESCRIPTION	CODE	NOTES	TWO DOOR	THREE DOOR	FOUR DOOR	FIVE DOOR
Push Latch	No Code	Push to open (no pull). Applied to all doors.	No Charge	No Charge	No Charge	No Charge
Handle Pull - Powder Coat	-HP	Pull to open. Applied to all doors.	\$157	\$236	\$314	\$392
Handle Pull - High Polish Finish	-HP-HPF	Pull to open. Applied to all doors.	\$277	\$416	\$554	\$693
Handle Pull - Clear Anodized	-HP-CA	Pull to open. Applied to all doors.	\$157	\$236	\$314	\$392
Handle Pull - Goldmatt Anodized	-HP-GMA	Pull to open. Applied to all doors.	\$230	\$345	\$460	\$575
Handle Pull - Antique Brass Anodized	-HP-ABA	Pull to open. Applied to all doors.	\$230	\$345	\$460	\$575
Handle Pull - Light Bronze Anodized	-HP-LBA	Pull to open. Applied to all doors.	\$230	\$345	\$460	\$575



STONE/QUARTZ TOP WITH SQUARE EDGE

PUSH LATCH OR HANDLE PULL OPTIONS	CODE	PRICE	NOTES
Locks	Add -LK	\$315	Locks included in all cabinets
Polished Chrome Base	Add -PCBB	\$501	
Wire Frame Pull-Out Waste/Recycling Unit Conference and Buffet Height Credenzas (excludes 36" width)			
(1) 20" Depth Single Wire Frame Unit	Add -TF1	\$309	Located in the rightmost cabinet, behind the right door
(1) 24" Depth Double Wire Frame Unit	Add -TF2	\$477	Located in the rightmost cabinet, behind the right door
Dual Wire Frame Pull-Out Waste/Recycling Units Conference and Buffet Height Credenzas (Excludes 36"-54" width)			
(2) 20" Depth Single Wire Frame Units	Add -TF3	\$617	Located in the rightmost cabinet, behind left and right doors
(2) 24" Depth Double Wire Frame Units	Add -TF4	\$954	Located in the rightmost cabinet, behind left and right doors
24" Depth Equipment Rack Options Available on Buffet Height Credenzas			
Fixed Equipment Rack	Add -R2	\$947	Located in left most cabinet, behind left and right doors
Sliding Equipment Rack	Add -R1	\$3,467	Located in left most cabinet, behind left and right doors

ADDITIONAL HANDLE PULL OPTIONS

Wood Frame Pull-Out Waste/Recycling Bin Unit Conference and Buffet Height Credenzas (Excludes 36" width)			
(1) 20" Depth Single Wood Frame Unit	Add -FWTF1	\$817	Located in the rightmost cabinet, applied to right door
(1) 24" Depth Double Wood Frame Unit	Add -FWTF2	\$1,225	Located in the rightmost cabinet, applied to right door
Dual Wood Frame Pull-Out Waste/Recycling Bin Unit Conference and Buffet Height Credenzas (Excludes 36"-54" width)			
(2) 20" Depth Single Wood Frame Units	Add -FWTF3	\$1,633	Located in the rightmost cabinet, applied to left and right doors
(2) 24" Depth Double Wood Frame Units	Add -FWTF4	\$2,450	Located in the rightmost cabinet, applied to left and right doors
24" Depth Single Pull-Out Drawer Refrigerator Available on Conference and Buffet Height Credenzas			
Pull-Out Drawer Refrigerator	Add -FWOM24	\$7,327	Located in left most cabinet, includes applied door panel

EDGE PROFILE



Square Edge

REQUIRED INFORMATION (ORDER CANNOT BE ENTERED WITHOUT THIS INFORMATION)

See appendix pages vi-viii for surface material options.

- Choose Door Style: Defaults to case finish, if none selected
- Choose Pull Style: Defaults to Push Latch, if none selected
- Choose Metal Finish
- Choose Stone/Quartz Finish
- Choose Paint Finish, if specified
- Choose Veneer Finish, if specified

GENERAL INFORMATION

- Stone/Quartz tops are 2cm thick
- When veneer case is specified, the case exterior is standard slip-match layout regardless of veneer door style selection
- Pull-Out Waste/Recycling Bin size: 17-7/8" x 8-3/32" x 11-9/16"; (1) 35 Qt.; Double Pull-Out Waste/Recycling Units include two bins
- When lock option is specified, color will default based on leg finish:
 - Aged Bronze, Black, Galaxy, Shadow, and Storm: Black
 - Cloud: White
 - Burnish, Foil, and Satin Bronze: Satin Nickel
 - Chrome: Polished Nickel
- Credenzas include one adjustable shelf behind each door unless other components are specified
- Equipment racks hold 12RU and include a thermostatically controlled fan and plug strip



STONE/QUARTZ TOP WITH FULL BULLNOSE EDGE

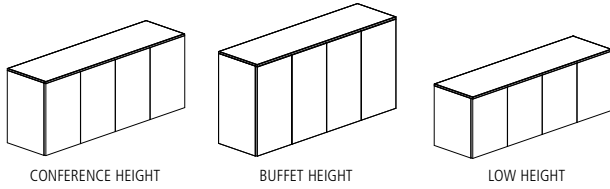

CASE MATERIAL KEY

PA Painted Case
V Veneer Case

CASE ONLY

MODEL #	W x D x H	DESCRIPTION	-PA	-V
CONFERENCE HEIGHT (29.5 INCH CASE)				
FWCC-3629-SB	36 x 20 x 29.5	Two Doors	7,567	8,405
FWCC-5429-SB	54 x 20 x 29.5	Three Doors	9,848	10,938
FWCC-7229-SB	72 x 20 x 29.5	Four Doors	12,134	13,481
FWCC-9029-SB	90 x 20 x 29.5	Five Doors	14,420	16,019
FWCD-3629-SB	36 x 24 x 29.5	Two Doors	8,323	9,246
FWCD-5429-SB	54 x 24 x 29.5	Three Doors	10,835	12,038
FWCD-7229-SB	72 x 24 x 29.5	Four Doors	13,347	14,827
FWCD-9029-SB	90 x 24 x 29.5	Five Doors	15,859	17,619
BUFFET HEIGHT (36.5 INCH CASE)				
FWBC-3636-SB	36 x 20 x 36.5	Two Doors	8,701	9,661
FWBC-5436-SB	54 x 20 x 36.5	Three Doors	11,323	12,578
FWBC-7236-SB	72 x 20 x 36.5	Four Doors	13,952	15,501
FWBC-9036-SB	90 x 20 x 36.5	Five Doors	16,578	18,418
FWBD-3636-SB	36 x 24 x 36.5	Two Doors	9,569	10,626
FWBD-5436-SB	54 x 24 x 36.5	Three Doors	12,454	13,837
FWBD-7236-SB	72 x 24 x 36.5	Four Doors	15,346	17,050
FWBD-9036-SB	90 x 24 x 36.5	Five Doors	18,235	20,260
LOW HEIGHT (24.5 INCH CASE)				
FWLC-3624-SB	36 x 20 x 24.5	Two Doors	7,006	7,785
FWLC-5424-SB	54 x 20 x 24.5	Three Doors	9,119	10,131
FWLC-7224-SB	72 x 20 x 24.5	Four Doors	11,234	12,484
FWLC-9024-SB	90 x 20 x 24.5	Five Doors	13,353	14,832
FWLD-3624-SB	36 x 24 x 24.5	Two Doors	7,707	8,563
FWLD-5424-SB	54 x 24 x 24.5	Three Doors	10,032	11,145
FWLD-7224-SB	72 x 24 x 24.5	Four Doors	12,358	13,731
FWLD-9024-SB	90 x 24 x 24.5	Five Doors	14,684	16,316

DOOR STYLE

DESCRIPTION	CODE	NOTES	PRICE
Vertical Veneer	-VD		No Charge
Horizontal Veneer	-HD		No Charge
Veneer/Paint Combination	-VPD	Reference page 8 for predetermined accent door locations	No Charge
Painted	-PAD		No Charge

PULL STYLE

DESCRIPTION	CODE	NOTES	TWO DOOR	THREE DOOR	FOUR DOOR	FIVE DOOR
Push Latch	No Code	Push to open (no pull). Applied to all doors.	No Charge	No Charge	No Charge	No Charge
Handle Pull - Powder Coat	-HP	Pull to open. Applied to all doors.	\$157	\$236	\$314	\$392
Handle Pull - High Polish Finish	-HP-HPF	Pull to open. Applied to all doors.	\$277	\$416	\$554	\$693
Handle Pull - Clear Anodized	-HP-CA	Pull to open. Applied to all doors.	\$157	\$236	\$314	\$392
Handle Pull - Goldmatt Anodized	-HP-GMA	Pull to open. Applied to all doors.	\$230	\$345	\$460	\$575
Handle Pull - Antique Brass Anodized	-HP-ABA	Pull to open. Applied to all doors.	\$230	\$345	\$460	\$575
Handle Pull - Light Bronze Anodized	-HP-LBA	Pull to open. Applied to all doors.	\$230	\$345	\$460	\$575



STONE/QUARTZ TOP WITH FULL BULLNOSE EDGE

PUSH LATCH OR HANDLE PULL OPTIONS	CODE	PRICE	NOTES
Locks	Add -LK	\$315	Locks included in all cabinets
Drawers Behind Doors	Add -D	\$614	Available on Buffet Height Credenza
Wire Frame Pull-Out Waste/Recycling Unit Conference, Buffet, and Low Height Credenzas (excludes 36" width)			
(1) 20" Depth Single Wire Frame Unit	Add -TF1	\$309	Located in the rightmost cabinet, behind the right door
(1) 24" Depth Double Wire Frame Unit	Add -TF2	\$477	Located in the rightmost cabinet, behind the right door
Dual Wire Frame Pull-Out Waste/Recycling Units Conference, Buffet, and Low Height Credenzas (Excludes 36"-54" width)			
(2) 20" Depth Single Wire Frame Units	Add -TF3	\$617	Located in the rightmost cabinet, behind left and right doors
(2) 24" Depth Double Wire Frame Units	Add -TF4	\$954	Located in the rightmost cabinet, behind left and right doors
24" Depth Equipment Rack Options Available on Conference and Buffet Height Credenzas			
Fixed Equipment Rack	Add -R2	\$947	Located in left most cabinet, behind left and right doors
Sliding Equipment Rack	Add -R1	\$3,467	Located in left most cabinet, behind left and right doors

ADDITIONAL HANDLE PULL OPTIONS

Wood Frame Pull-Out Waste/Recycling Bin Unit Conference, Buffet, and Low Height Credenzas (Excludes 36" width)			
(1) 20" Depth Single Wood Frame Unit	Add -FWTF1	\$817	Located in the rightmost cabinet, applied to right door
(1) 24" Depth Double Wood Frame Unit	Add -FWTF2	\$1,225	Located in the rightmost cabinet, applied to right door
Dual Wood Frame Pull-Out Waste/Recycling Bin Unit Conference, Buffet, and Low Height Credenzas (Excludes 36"-54" width)			
(2) 20" Depth Single Wood Frame Units	Add -FWTF3	\$1,633	Located in the rightmost cabinet, applied to left and right doors
(2) 24" Depth Double Wood Frame Units	Add -FWTF4	\$2,450	Located in the rightmost cabinet, applied to left and right doors
24" Depth Single Pull-Out Drawer Refrigerator Available on Conference and Low Height Credenzas			
Pull-Out Drawer Refrigerator	Add -FWOM24	\$7,327	Located in left most cabinet, includes applied door panel

EDGE PROFILE



Full Bullnose Edge

REQUIRED INFORMATION (ORDER CANNOT BE ENTERED WITHOUT THIS INFORMATION)

See appendix pages vi-viii for surface material options.

- Choose Door Style: Defaults to case finish, if none selected
- Choose Pull Style: Defaults to Push Latch, if none selected
- Choose Stone/Quartz Finish
- Choose Paint Finish, if specified
- Choose Veneer Finish, if specified

GENERAL INFORMATION

- Stone/Quartz tops are 2cm thick
- When veneer case is specified, the case exterior is standard slip-match layup regardless of veneer door style selection
- Pull-Out Waste/Recycling Bin size: 17-7/8" x 8-3/32" x 11-9/16"; (1) 35 Qt.; Double Pull-Out Waste/Recycling Units include two bins
- Locks
 - Veneer (Case Only) - When lock option is specified, color will default to Satin Nickel
 - Painted (Case Only) - When lock option is specified, color will default based on Paint finish:
 - Aged Bronze, Black, Galaxy, Shadow, and Storm: Black
 - Cloud: White
 - Burnish, Foil, Satin Bronze: Satin Nickel
 - Chrome: Polished Nickel
- Credenzas include one adjustable shelf behind each door unless other components are specified
- Equipment racks hold 12RU and include a thermostatically controlled fan and plug strip



STONE/QUARTZ TOP WITH FULL BULLNOSE EDGE

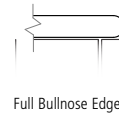
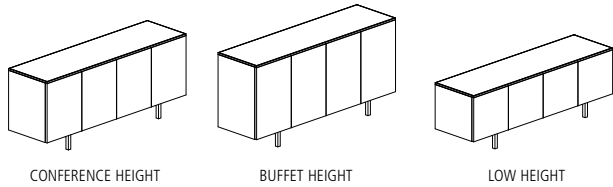

CASE MATERIAL KEY

PA-IB Painted Case with Inset Leg
 V-IB Veneer Case with Inset Leg

INSET LEG

MODEL #	W x D x H	DESCRIPTION	-PA-IB	-V-IB
CONFERENCE HEIGHT (24 IN. CASE WITH 6.5 IN. INSET LEG)				
FWLC-3629-SB	36 x 20 x 30.5	Two Doors	7,483	8,263
FWLC-5429-SB	54 x 20 x 30.5	Three Doors	9,599	10,611
FWLC-7229-SB	72 x 20 x 30.5	Four Doors	11,714	12,961
FWLC-9029-SB	90 x 20 x 30.5	Five Doors	13,829	15,312
BUFFET HEIGHT (29 IN. CASE WITH 6.5 IN. INSET LEG)				
FWCC-3636-SB	36 x 20 x 35.5	Two Doors	8,045	8,885
FWCC-5436-SB	54 x 20 x 35.5	Three Doors	10,329	11,421
FWCC-7236-SB	72 x 20 x 35.5	Four Doors	12,613	13,960
FWCC-9036-SB	90 x 20 x 35.5	Five Doors	14,898	16,498
LOW HEIGHT (18 IN. CASE WITH 6.5 IN. INSET LEG)				
FWWC-3624-SB	36 x 20 x 24.5	Two Doors	6,910	7,625
FWWC-5424-SB	54 x 20 x 24.5	Three Doors	8,857	9,783
FWWC-7224-SB	72 x 20 x 24.5	Four Doors	10,792	11,938
FWWC-9024-SB	90 x 20 x 24.5	Five Doors	12,736	14,095

DOOR STYLE

DESCRIPTION	CODE	NOTES	PRICE
Vertical Veneer	-VD		No Charge
Horizontal Veneer	-HD		No Charge
Veneer/Paint Combination	-VPD	Reference page 8 for predetermined accent door locations	No Charge
Painted	-PAD		No Charge

PULL STYLE

DESCRIPTION	CODE	NOTES	TWO DOOR	THREE DOOR	FOUR DOOR	FIVE DOOR
Push Latch	No Code	Push to open (no pull). Applied to all doors.	No Charge	No Charge	No Charge	No Charge
Handle Pull - Powder Coat	-HP	Pull to open. Applied to all doors.	\$157	\$236	\$314	\$392
Handle Pull - High Polish Finish	-HP-HPF	Pull to open. Applied to all doors.	\$277	\$416	\$554	\$693
Handle Pull - Clear Anodized	-HP-CA	Pull to open. Applied to all doors.	\$157	\$236	\$314	\$392
Handle Pull - Goldmatt Anodized	-HP-GMA	Pull to open. Applied to all doors.	\$230	\$345	\$460	\$575
Handle Pull - Antique Brass Anodized	-HP-ABA	Pull to open. Applied to all doors.	\$230	\$345	\$460	\$575
Handle Pull - Light Bronze Anodized	-HP-LBA	Pull to open. Applied to all doors.	\$230	\$345	\$460	\$575



STONE/QUARTZ TOP WITH FULL BULLNOSE EDGE

PUSH LATCH OR HANDLE PULL OPTIONS	CODE	PRICE	NOTES
Locks	Add -LK	\$315	Locks included in all cabinets
Polished Chrome Base	Add -PCIB	\$501	
Wire Frame Pull-Out Waste/Recycling Unit Conference and Buffet Height Credenzas (excludes 36" width)			
(1) 20" Depth Single Wire Frame Unit	Add -TF1	\$309	Located in the rightmost cabinet, behind the right door
(1) 24" Depth Double Wire Frame Unit	Add -TF2	\$477	Located in the rightmost cabinet, behind the right door
Dual Wire Frame Pull-Out Waste/Recycling Units Conference and Buffet Height Credenzas (Excludes 36"-54" width)			
(2) 20" Depth Single Wire Frame Units	Add -TF3	\$617	Located in the rightmost cabinet, behind left and right doors
(2) 24" Depth Double Wire Frame Units	Add -TF4	\$954	Located in the rightmost cabinet, behind left and right doors
24" Depth Equipment Rack Options Available on Buffet Height Credenzas			
Fixed Equipment Rack	Add -R2	\$947	Located in left most cabinet, behind left and right doors
Sliding Equipment Rack	Add -R1	\$3,467	Located in left most cabinet, behind left and right doors

ADDITIONAL HANDLE PULL OPTIONS

Wood Frame Pull-Out Waste/Recycling Bin Unit Conference and Buffet Height Credenzas (Excludes 36" width)			
(1) 20" Depth Single Wood Frame Unit	Add -FWTF1	\$817	Located in the rightmost cabinet, applied to right door
(1) 24" Depth Double Wood Frame Unit	Add -FWTF2	\$1,225	Located in the rightmost cabinet, applied to right door
Dual Wood Frame Pull-Out Waste/Recycling Bin Unit Conference and Buffet Height Credenzas (Excludes 36"-54" width)			
(2) 20" Depth Single Wood Frame Units	Add -FWTF3	\$1,633	Located in the rightmost cabinet, applied to left and right doors
(2) 24" Depth Double Wood Frame Units	Add -FWTF4	\$2,450	Located in the rightmost cabinet, applied to left and right doors
24" Depth Single Pull-Out Drawer Refrigerator Available on Conference and Buffet Height Credenzas			
Pull-Out Drawer Refrigerator	Add -FWOM24	\$7,327	Located in left most cabinet, includes applied door panel

EDGE PROFILE



Full Bullnose Edge

REQUIRED INFORMATION (ORDER CANNOT BE ENTERED WITHOUT THIS INFORMATION)

See appendix pages vi-viii for surface material options.

- Choose Door Style: Defaults to case finish, if none selected
- Choose Pull Style: Defaults to Push Latch, if none selected
- Choose Metal Finish
- Choose Stone/Quartz Finish
- Choose Paint Finish, if specified
- Choose Veneer Finish, if specified

GENERAL INFORMATION

- Stone/Quartz tops are 2cm thick
- When veneer case is specified, the case exterior is standard slip-match layout regardless of veneer door style selection
- Pull-Out Waste/Recycling Bin size: 17-7/8" x 8-3/32" x 11-9/16"; (1) 35 Qt.; Double Pull-Out Waste/Recycling Units include two bins
- When lock option is specified, color will default based on leg finish:
 - Aged Bronze, Black, Galaxy, Shadow, and Storm: Black
 - Cloud: White
 - Burnish, Foil, and Satin Bronze: Satin Nickel
 - Chrome: Polished Nickel
- Credenzas include one adjustable shelf behind each door unless other components are specified
- Equipment racks hold 12RU and include a thermostatically controlled fan and plug strip



STONE/QUARTZ TOP WITH FULL BULLNOSE EDGE

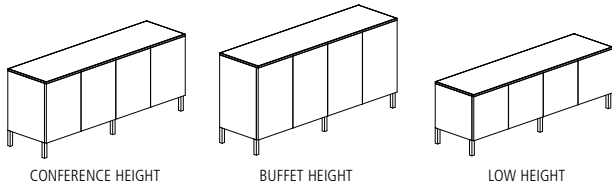

CASE MATERIAL KEY

PA-OB Painted Case with Edge-mount Post Leg
 V-OB Veneer Case with Edge-mount Post Leg

EDGE-MOUNT POST LEG

MODEL #	W x D x H	DESCRIPTION	-PA-OB	-V-OB
CONFERENCE HEIGHT (24 IN. CASE WITH 6.5 IN. EDGE-MOUNT POST LEG)				
FWLC-3629-SB	36 x 20 x 30.5	Two Door	7,483	8,263
FWLC-5429-SB	54 x 20 x 30.5	Three Door	9,599	10,611
FWLC-7229-SB	72 x 20 x 30.5	Four Door	11,714	12,961
FWLC-9029-SB	90 x 20 x 30.5	Five Door	13,829	15,312
FWLD-3629-SB	36 x 24 x 30.5	Two Door	8,184	9,042
FWLD-5429-SB	54 x 24 x 30.5	Three Door	10,510	11,625
FWLD-7229-SB	72 x 24 x 30.5	Four Door	12,836	14,210
FWLD-9029-SB	90 x 24 x 30.5	Five Door	15,164	16,796
BUFFET HEIGHT (29 IN. CASE WITH 6.5 IN. EDGE-MOUNT POST LEG)				
FWCC-3636-SB	36 x 20 x 35.5	Two Door	8,045	8,885
FWCC-5436-SB	54 x 20 x 35.5	Three Door	10,329	11,421
FWCC-7236-SB	72 x 20 x 35.5	Four Door	12,613	13,960
FWCC-9036-SB	90 x 20 x 35.5	Five Door	14,898	16,498
FWCD-3636-SB	36 x 24 x 35.5	Two Door	8,800	9,726
FWCD-5436-SB	54 x 24 x 35.5	Three Door	11,314	12,514
FWCD-7236-SB	72 x 24 x 35.5	Four Door	13,823	15,306
FWCD-9036-SB	90 x 24 x 35.5	Five Door	16,339	18,099
LOW HEIGHT (18 IN. CASE WITH 6.5 IN. EDGE-MOUNT POST LEG)				
FWWC-3624-SB	36 x 20 x 24.5	Two Door	6,910	7,625
FWWC-5424-SB	54 x 20 x 24.5	Three Door	8,857	9,783
FWWC-7224-SB	72 x 20 x 24.5	Four Door	10,792	11,938
FWWC-9024-SB	90 x 20 x 24.5	Five Door	12,736	14,095

DOOR STYLE

DESCRIPTION	CODE	NOTES	PRICE
Vertical Veneer	-VD		No Charge
Horizontal Veneer	-HD		No Charge
Veneer/Paint Combination	-VPD	Reference page 8 for predetermined accent door locations	No Charge
Painted	-PAD		No Charge

PULL STYLE

DESCRIPTION	CODE	NOTES	TWO DOOR	THREE DOOR	FOUR DOOR	FIVE DOOR
Push Latch	No Code	Push to open (no pull). Applied to all doors.	No Charge	No Charge	No Charge	No Charge
Handle Pull - Powder Coat	-HP	Pull to open. Applied to all doors.	\$157	\$236	\$314	\$392
Handle Pull - High Polish Finish	-HP-HPF	Pull to open. Applied to all doors.	\$277	\$416	\$554	\$693
Handle Pull - Clear Anodized	-HP-CA	Pull to open. Applied to all doors.	\$157	\$236	\$314	\$392
Handle Pull - Goldmatt Anodized	-HP-GMA	Pull to open. Applied to all doors.	\$230	\$345	\$460	\$575
Handle Pull - Antique Brass Anodized	-HP-ABA	Pull to open. Applied to all doors.	\$230	\$345	\$460	\$575
Handle Pull - Light Bronze Anodized	-HP-LBA	Pull to open. Applied to all doors.	\$230	\$345	\$460	\$575



STONE/QUARTZ TOP WITH FULL BULLNOSE EDGE

PUSH LATCH OR HANDLE PULL OPTIONS	CODE	PRICE	NOTES
Locks	Add -LK	\$315	Locks included in all cabinets
Polished Chrome Base	Add -PCOB	\$541	
Wire Frame Pull-Out Waste/Recycling Unit Conference and Buffet Height Credenzas (excludes 36" width)			
(1) 20" Depth Single Wire Frame Unit	Add -TF1	\$309	Located in the rightmost cabinet, behind the right door
(1) 24" Depth Double Wire Frame Unit	Add -TF2	\$477	Located in the rightmost cabinet, behind the right door
Dual Wire Frame Pull-Out Waste/Recycling Units Conference and Buffet Height Credenzas (Excludes 36"-54" width)			
(2) 20" Depth Single Wire Frame Units	Add -TF3	\$617	Located in the rightmost cabinet, behind left and right doors
(2) 24" Depth Double Wire Frame Units	Add -TF4	\$954	Located in the rightmost cabinet, behind left and right doors
24" Depth Equipment Rack Options Available on Buffet Height Credenzas			
Fixed Equipment Rack	Add -R2	\$947	Located in left most cabinet, behind left and right doors
Sliding Equipment Rack	Add -R1	\$3,467	Located in left most cabinet, behind left and right doors

ADDITIONAL HANDLE PULL OPTIONS

Wood Frame Pull-Out Waste/Recycling Bin Unit Conference and Buffet Height Credenzas (Excludes 36" width)			
(1) 20" Depth Single Wood Frame Unit	Add -FWTF1	\$817	Located in the rightmost cabinet, applied to right door
(1) 24" Depth Double Wood Frame Unit	Add -FWTF2	\$1,225	Located in the rightmost cabinet, applied to right door
Dual Wood Frame Pull-Out Waste/Recycling Bin Unit Conference and Buffet Height Credenzas (Excludes 36"-54" width)			
(2) 20" Depth Single Wood Frame Units	Add -FWTF3	\$1,633	Located in the rightmost cabinet, applied to left and right doors
(2) 24" Depth Double Wood Frame Units	Add -FWTF4	\$2,450	Located in the rightmost cabinet, applied to left and right doors
24" Depth Single Pull-Out Drawer Refrigerator Available on Conference and Buffet Height Credenzas			
Pull-Out Drawer Refrigerator	Add -FWOM24	\$7,327	Located in left most cabinet, includes applied door panel

EDGE PROFILE



Full Bullnose Edge

REQUIRED INFORMATION (ORDER CANNOT BE ENTERED WITHOUT THIS INFORMATION)

See appendix pages vi-viii for surface material options.

- Choose Door Style: Defaults to case finish, if none selected
- Choose Pull Style: Defaults to Push Latch, if none selected
- Choose Metal Finish
- Choose Stone/Quartz Finish
- Choose Paint Finish, if specified
- Choose Veneer Finish, if specified

GENERAL INFORMATION

- Stone/Quartz tops are 2cm thick
- When veneer case is specified, the case exterior is standard slip-match layout regardless of veneer door style selection
- Pull-Out Waste/Recycling Bin size: 17-7/8" x 8-3/32" x 11-9/16"; (1) 35 Qt.; Double Pull-Out Waste/Recycling Units include two bins
- When lock option is specified, color will default based on leg finish:
 - Aged Bronze, Black, Galaxy, Shadow, and Storm: Black
 - Cloud: White
 - Burnish, Foil, and Satin Bronze: Satin Nickel
 - Chrome: Polished Nickel
- Credenzas include one adjustable shelf behind each door unless other components are specified
- Equipment racks hold 12RU and include a thermostatically controlled fan and plug strip



STONE/QUARTZ TOP WITH FULL BULLNOSE EDGE

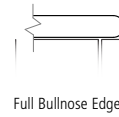
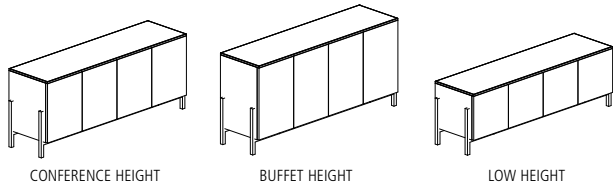

CASE MATERIAL KEY

PA-CB Painted Case with Cradle Base
 V-CB Veneer Case with Cradle Base

CRADLE BASE

MODEL #	W x D x H	DESCRIPTION	-PA-CB	-V-CB
CONFERENCE HEIGHT (24 IN. CASE WITH 6.5 IN. CRADLE BASE)				
FWLC-3629-SB	36 x 20 x 30.5	Two Doors	8,125	8,902
FWLC-5429-SB	54 x 20 x 30.5	Three Doors	10,240	11,248
FWLC-7229-SB	72 x 20 x 30.5	Four Doors	12,353	13,599
FWLC-9029-SB	90 x 20 x 30.5	Five Doors	14,469	15,949
FWLD-3629-SB	36 x 24 x 30.5	Two Doors	8,827	9,680
FWLD-5429-SB	54 x 24 x 30.5	Three Doors	11,148	12,263
FWLD-7229-SB	72 x 24 x 30.5	Four Doors	13,476	14,850
FWLD-9029-SB	90 x 24 x 30.5	Five Doors	15,803	17,433
BUFFET HEIGHT (29 IN. CASE WITH 6.5 IN. CRADLE BASE)				
FWCC-3636-SB	36 x 20 x 35.5	Two Doors	8,683	9,523
FWCC-5436-SB	54 x 20 x 35.5	Three Doors	10,966	12,058
FWCC-7236-SB	72 x 20 x 35.5	Four Doors	13,251	14,598
FWCC-9036-SB	90 x 20 x 35.5	Five Doors	15,535	17,135
FWCD-3636-SB	36 x 24 x 35.5	Two Doors	9,439	10,365
FWCD-5436-SB	54 x 24 x 35.5	Three Doors	11,949	13,153
FWCD-7236-SB	72 x 24 x 35.5	Four Doors	14,464	15,946
FWCD-9036-SB	90 x 24 x 35.5	Five Doors	16,978	18,739
LOW HEIGHT (18 IN. CASE WITH 6.5 IN. CRADLE BASE)				
FWWC-3624-SB	36 x 20 x 24.5	Two Doors	7,549	8,264
FWWC-5424-SB	54 x 20 x 24.5	Three Doors	9,496	10,423
FWWC-7224-SB	72 x 20 x 24.5	Four Doors	11,432	12,578
FWWC-9024-SB	90 x 20 x 24.5	Five Doors	13,373	14,736

DOOR STYLE

DESCRIPTION	CODE	NOTES	PRICE
Vertical Veneer	-VD		No Charge
Horizontal Veneer	-HD		No Charge
Veneer/Paint Combination	-VPD	Reference page 8 for predetermined accent door locations	No Charge
Painted	-PAD		No Charge

PULL STYLE

DESCRIPTION	CODE	NOTES	TWO DOOR	THREE DOOR	FOUR DOOR	FIVE DOOR
Push Latch	No Code	Push to open (no pull). Applied to all doors.	No Charge	No Charge	No Charge	No Charge
Handle Pull - Powder Coat	-HP	Pull to open. Applied to all doors.	\$157	\$236	\$314	\$392
Handle Pull - High Polish Finish	-HP-HPF	Pull to open. Applied to all doors.	\$277	\$416	\$554	\$693
Handle Pull - Clear Anodized	-HP-CA	Pull to open. Applied to all doors.	\$157	\$236	\$314	\$392
Handle Pull - Goldmatt Anodized	-HP-GMA	Pull to open. Applied to all doors.	\$230	\$345	\$460	\$575
Handle Pull - Antique Brass Anodized	-HP-ABA	Pull to open. Applied to all doors.	\$230	\$345	\$460	\$575
Handle Pull - Light Bronze Anodized	-HP-LBA	Pull to open. Applied to all doors.	\$230	\$345	\$460	\$575



STONE/QUARTZ TOP WITH FULL BULLNOSE EDGE

PUSH LATCH OR HANDLE PULL OPTIONS	CODE	PRICE	NOTES
Locks	Add -LK	\$315	Locks included in all cabinets
Polished Chrome Base	Add -PCCB	\$1,775	
Wire Frame Pull-Out Waste/Recycling Unit Conference and Buffet Height Credenzas (excludes 36" width)			
(1) 20" Depth Single Wire Frame Unit	Add -TF1	\$309	Located in the rightmost cabinet, behind the right door
(1) 24" Depth Double Wire Frame Unit	Add -TF2	\$477	Located in the rightmost cabinet, behind the right door
Dual Wire Frame Pull-Out Waste/Recycling Units Conference and Buffet Height Credenzas (Excludes 36"-54" width)			
(2) 20" Depth Single Wire Frame Units	Add -TF3	\$617	Located in the rightmost cabinet, behind left and right doors
(2) 24" Depth Double Wire Frame Units	Add -TF4	\$954	Located in the rightmost cabinet, behind left and right doors
24" Depth Equipment Rack Options Available on Buffet Height Credenzas			
Fixed Equipment Rack	Add -R2	\$947	Located in left most cabinet, behind left and right doors
Sliding Equipment Rack	Add -R1	\$3,467	Located in left most cabinet, behind left and right doors

ADDITIONAL HANDLE PULL OPTIONS

Wood Frame Pull-Out Waste/Recycling Bin Unit Conference and Buffet Height Credenzas (Excludes 36" width)			
(1) 20" Depth Single Wood Frame Unit	Add -FWTF1	\$817	Located in the rightmost cabinet, applied to right door
(1) 24" Depth Double Wood Frame Unit	Add -FWTF2	\$1,225	Located in the rightmost cabinet, applied to right door
Dual Wood Frame Pull-Out Waste/Recycling Bin Unit Conference and Buffet Height Credenzas (Excludes 36"-54" width)			
(2) 20" Depth Single Wood Frame Units	Add -FWTF3	\$1,633	Located in the rightmost cabinet, applied to left and right doors
(2) 24" Depth Double Wood Frame Units	Add -FWTF4	\$2,450	Located in the rightmost cabinet, applied to left and right doors
24" Depth Single Pull-Out Drawer Refrigerator Available on Conference and Buffet Height Credenzas			
Pull-Out Drawer Refrigerator	Add -FWOM24	\$7,327	Located in left most cabinet, includes applied door panel

EDGE PROFILE



Full Bullnose Edge

REQUIRED INFORMATION (ORDER CANNOT BE ENTERED WITHOUT THIS INFORMATION)

See appendix pages vi-viii for surface material options.

- Choose Door Style: Defaults to case finish, if none selected
- Choose Pull Style: Defaults to Push Latch, if none selected
- Choose Metal Finish
- Choose Stone/Quartz Finish
- Choose Paint Finish, if specified
- Choose Veneer Finish, if specified

GENERAL INFORMATION

- Stone/Quartz tops are 2cm thick
- When veneer case is specified, the case exterior is standard slip-match layout regardless of veneer door style selection
- Pull-Out Waste/Recycling Bin size: 17-7/8" x 8-3/32" x 11-9/16"; (1) 35 Qt.; Double Pull-Out Waste/Recycling Units include two bins
- When lock option is specified, color will default based on leg finish:
 - Aged Bronze, Black, Galaxy, Shadow, and Storm: Black
 - Cloud: White
 - Burnish, Foil, and Satin Bronze: Satin Nickel
 - Chrome: Polished Nickel
- Credenzas include one adjustable shelf behind each door unless other components are specified
- Equipment racks hold 12RU and include a thermostatically controlled fan and plug strip



STONE/QUARTZ TOP WITH FULL BULLNOSE EDGE

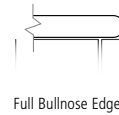
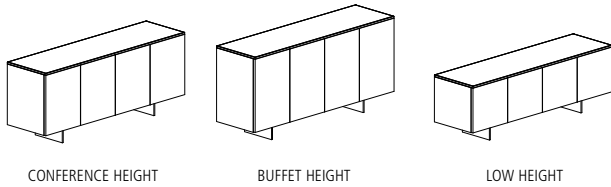

CASE MATERIAL KEY

PA-BB Painted Case with Blade Base
 V-BB Veneer Case with Blade Base

BLADE BASE

MODEL #	W x D x H	DESCRIPTION	-PA-BB	-V-BB
CONFERENCE HEIGHT (24 IN. CASE WITH 6 IN. BLADE BASE)				
FWLC-3629-SB	36 x 20 x 30	Two Doors	7,804	8,581
FWLC-5429-SB	54 x 20 x 30	Three Doors	9,919	10,929
FWLC-7229-SB	72 x 20 x 30	Four Doors	12,033	13,282
FWLC-9029-SB	90 x 20 x 30	Five Doors	14,149	15,631
FWLD-3629-SB	36 x 24 x 30	Two Doors	8,506	9,359
FWLD-5429-SB	54 x 24 x 30	Three Doors	10,833	11,944
FWLD-7229-SB	72 x 24 x 30	Four Doors	13,158	14,528
FWLD-9029-SB	90 x 24 x 30	Five Doors	15,485	17,113
BUFFET HEIGHT (29 IN. CASE WITH 6 IN. BLADE BASE)				
FWCC-3636-SB	36 x 20 x 35	Two Doors	8,366	9,202
FWCC-5436-SB	54 x 20 x 35	Three Doors	10,648	11,738
FWCC-7236-SB	72 x 20 x 35	Four Doors	12,933	14,282
FWCC-9036-SB	90 x 20 x 35	Five Doors	15,218	16,814
FWCD-3636-SB	36 x 24 x 35	Two Doors	9,119	10,045
FWCD-5436-SB	54 x 24 x 35	Three Doors	11,630	12,834
FWCD-7236-SB	72 x 24 x 35	Four Doors	14,146	15,628
FWCD-9036-SB	90 x 24 x 35	Five Doors	16,659	18,419
LOW HEIGHT (18 IN. CASE WITH 6 IN. BLADE BASE)				
FWWC-3624-SB	36 x 20 x 24	Two Doors	7,230	7,944
FWWC-5424-SB	54 x 20 x 24	Three Doors	9,175	10,102
FWWC-7224-SB	72 x 20 x 24	Four Doors	11,114	12,260
FWWC-9024-SB	90 x 20 x 24	Five Doors	13,056	14,415

DOOR STYLE

DESCRIPTION	CODE	NOTES	PRICE
Vertical Veneer	-VD		No Charge
Horizontal Veneer	-HD		No Charge
Veneer/Paint Combination	-VPD	Reference page 8 for predetermined accent door locations	No Charge
Painted	-PAD		No Charge

PULL STYLE

DESCRIPTION	CODE	NOTES	TWO DOOR	THREE DOOR	FOUR DOOR	FIVE DOOR
Push Latch	No Code	Push to open (no pull). Applied to all doors.	No Charge	No Charge	No Charge	No Charge
Handle Pull - Powder Coat	-HP	Pull to open. Applied to all doors.	\$157	\$236	\$314	\$392
Handle Pull - High Polish Finish	-HP-HPF	Pull to open. Applied to all doors.	\$277	\$416	\$554	\$693
Handle Pull - Clear Anodized	-HP-CA	Pull to open. Applied to all doors.	\$157	\$236	\$314	\$392
Handle Pull - Goldmatt Anodized	-HP-GMA	Pull to open. Applied to all doors.	\$230	\$345	\$460	\$575
Handle Pull - Antique Brass Anodized	-HP-ABA	Pull to open. Applied to all doors.	\$230	\$345	\$460	\$575
Handle Pull - Light Bronze Anodized	-HP-LBA	Pull to open. Applied to all doors.	\$230	\$345	\$460	\$575



STONE/QUARTZ TOP WITH FULL BULLNOSE EDGE

PUSH LATCH OR HANDLE PULL OPTIONS	CODE	PRICE	NOTES
Locks	Add -LK	\$315	Locks included in all cabinets
Polished Chrome Base	Add -PCBB	\$501	
Wire Frame Pull-Out Waste/Recycling Unit Conference and Buffet Height Credenzas (excludes 36" width)			
(1) 20" Depth Single Wire Frame Unit	Add -TF1	\$309	Located in the rightmost cabinet, behind the right door
(1) 24" Depth Double Wire Frame Unit	Add -TF2	\$477	Located in the rightmost cabinet, behind the right door
Dual Wire Frame Pull-Out Waste/Recycling Units Conference and Buffet Height Credenzas (Excludes 36"-54" width)			
(2) 20" Depth Single Wire Frame Units	Add -TF3	\$617	Located in the rightmost cabinet, behind left and right doors
(2) 24" Depth Double Wire Frame Units	Add -TF4	\$954	Located in the rightmost cabinet, behind left and right doors
24" Depth Equipment Rack Options Available on Buffet Height Credenzas			
Fixed Equipment Rack	Add -R2	\$947	Located in left most cabinet, behind left and right doors
Sliding Equipment Rack	Add -R1	\$3,467	Located in left most cabinet, behind left and right doors

ADDITIONAL HANDLE PULL OPTIONS

Wood Frame Pull-Out Waste/Recycling Bin Unit Conference and Buffet Height Credenzas (Excludes 36" width)			
(1) 20" Depth Single Wood Frame Unit	Add -FWTF1	\$817	Located in the rightmost cabinet, applied to right door
(1) 24" Depth Double Wood Frame Unit	Add -FWTF2	\$1,225	Located in the rightmost cabinet, applied to right door
Dual Wood Frame Pull-Out Waste/Recycling Bin Unit Conference and Buffet Height Credenzas (Excludes 36"-54" width)			
(2) 20" Depth Single Wood Frame Units	Add -FWTF3	\$1,633	Located in the rightmost cabinet, applied to left and right doors
(2) 24" Depth Double Wood Frame Units	Add -FWTF4	\$2,450	Located in the rightmost cabinet, applied to left and right doors
24" Depth Single Pull-Out Drawer Refrigerator Available on Conference and Buffet Height Credenzas			
Pull-Out Drawer Refrigerator	Add -FWOM24	\$7,327	Located in left most cabinet, includes applied door panel

EDGE PROFILE



Full Bullnose Edge

REQUIRED INFORMATION (ORDER CANNOT BE ENTERED WITHOUT THIS INFORMATION)

See appendix pages vi-viii for surface material options.

- Choose Door Style: Defaults to case finish, if none selected
- Choose Pull Style: Defaults to Push Latch, if none selected
- Choose Metal Finish
- Choose Stone/Quartz Finish
- Choose Paint Finish, if specified
- Choose Veneer Finish, if specified

GENERAL INFORMATION

- Stone/Quartz tops are 2cm thick
- When veneer case is specified, the case exterior is standard slip-match layout regardless of veneer door style selection
- Pull-Out Waste/Recycling Bin size: 17-7/8" x 8-3/32" x 11-9/16"; (1) 35 Qt.; Double Pull-Out Waste/Recycling Units include two bins
- When lock option is specified, color will default based on leg finish:
 - Aged Bronze, Black, Galaxy, Shadow, and Storm: Black
 - Cloud: White
 - Burnish, Foil, and Satin Bronze: Satin Nickel
 - Chrome: Polished Nickel
- Credenzas include one adjustable shelf behind each door unless other components are specified
- Equipment racks hold 12RU and include a thermostatically controlled fan and plug strip



SOLID SURFACE TOP

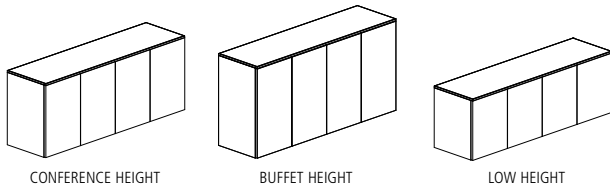

CASE MATERIAL KEY

PA Painted Case
V Veneer Case

CASE ONLY

MODEL #	W x D x H	DESCRIPTION	-PA	-V
CONFERENCE HEIGHT (29 INCH CASE)				
FWCC-3629-SS	36 x 20 x 29.25	Two Doors	6,802	7,556
FWCC-5429-SS	54 x 20 x 29.25	Three Doors	8,854	9,839
FWCC-7229-SS	72 x 20 x 29.25	Four Doors	10,907	12,120
FWCC-9029-SS	90 x 20 x 29.25	Five Doors	12,964	14,400
FWCD-3629-SS	36 x 24 x 29.25	Two Doors	7,483	8,310
FWCD-5429-SS	54 x 24 x 29.25	Three Doors	9,740	10,821
FWCD-7229-SS	72 x 24 x 29.25	Four Doors	11,998	13,331
FWCD-9029-SS	90 x 24 x 29.25	Five Doors	14,256	15,841
BUFFET HEIGHT (36 INCH CASE)				
FWBC-3636-SS	36 x 20 x 36.25	Two Doors	7,818	8,691
FWBC-5436-SS	54 x 20 x 36.25	Three Doors	10,179	11,309
FWBC-7236-SS	72 x 20 x 36.25	Four Doors	12,542	13,931
FWBC-9036-SS	90 x 20 x 36.25	Five Doors	14,903	16,560
FWBD-3636-SS	36 x 24 x 36.25	Two Doors	8,604	9,557
FWBD-5436-SS	54 x 24 x 36.25	Three Doors	11,198	12,438
FWBD-7236-SS	72 x 24 x 36.25	Four Doors	13,796	15,330
FWBD-9036-SS	90 x 24 x 36.25	Five Doors	16,393	18,214
LOW HEIGHT (24 INCH CASE)				
FWLC-3624-SS	36 x 20 x 24.25	Two Doors	6,301	6,997
FWLC-5424-SS	54 x 20 x 24.25	Three Doors	8,199	9,114
FWLC-7224-SS	72 x 20 x 24.25	Four Doors	10,100	11,224
FWLC-9024-SS	90 x 20 x 24.25	Five Doors	12,002	13,335
FWLD-3624-SS	36 x 24 x 24.25	Two Doors	6,926	7,696
FWLD-5424-SS	54 x 24 x 24.25	Three Doors	9,019	10,020
FWLD-7224-SS	72 x 24 x 24.25	Four Doors	11,111	12,345
FWLD-9024-SS	90 x 24 x 24.25	Five Doors	13,202	14,669

DOOR STYLE

DESCRIPTION	CODE	NOTES	PRICE
Vertical Veneer	-VD		No Charge
Horizontal Veneer	-HD		No Charge
Veneer/Paint Combination	-VPD	Reference page 8 for predetermined accent door locations	No Charge
Painted	-PAD		No Charge

PULL STYLE

DESCRIPTION	CODE	NOTES	TWO DOOR	THREE DOOR	FOUR DOOR	FIVE DOOR
Push Latch	No Code	Push to open (no pull). Applied to all doors.	No Charge	No Charge	No Charge	No Charge
Handle Pull - Powder Coat	-HP	Pull to open. Applied to all doors.	\$157	\$236	\$314	\$392
Handle Pull - High Polish Finish	-HP-HPF	Pull to open. Applied to all doors.	\$277	\$416	\$554	\$693
Handle Pull - Clear Anodized	-HP-CA	Pull to open. Applied to all doors.	\$157	\$236	\$314	\$392
Handle Pull - Goldmatt Anodized	-HP-GMA	Pull to open. Applied to all doors.	\$230	\$345	\$460	\$575
Handle Pull - Antique Brass Anodized	-HP-ABA	Pull to open. Applied to all doors.	\$230	\$345	\$460	\$575
Handle Pull - Light Bronze Anodized	-HP-LBA	Pull to open. Applied to all doors.	\$230	\$345	\$460	\$575



SOLID SURFACE TOP

PUSH LATCH OR HANDLE PULL OPTIONS	CODE	PRICE	NOTES
Locks	Add -LK	\$315	Locks included in all cabinets
Drawers Behind Doors	Add -D	\$614	Available on Buffet Height Credenza
Wire Frame Pull-Out Waste/Recycling Unit Conference, Buffet, and Low Height Credenzas (excludes 36" width)			
(1) 20" Depth Single Wire Frame Unit	Add -TF1	\$309	Located in the rightmost cabinet, behind the right door
(1) 24" Depth Double Wire Frame Unit	Add -TF2	\$477	Located in the rightmost cabinet, behind the right door
Dual Wire Frame Pull-Out Waste/Recycling Units Conference, Buffet, and Low Height Credenzas (Excludes 36"-54" width)			
(2) 20" Depth Single Wire Frame Units	Add -TF3	\$617	Located in the rightmost cabinet, behind left and right doors
(2) 24" Depth Double Wire Frame Units	Add -TF4	\$954	Located in the rightmost cabinet, behind left and right doors
24" Depth Equipment Rack Options Available on Conference and Buffet Height Credenzas			
Fixed Equipment Rack	Add -R2	\$947	Located in left most cabinet, behind left and right doors
Sliding Equipment Rack	Add -R1	\$3,467	Located in left most cabinet, behind left and right doors

ADDITIONAL HANDLE PULL OPTIONS

Wood Frame Pull-Out Waste/Recycling Bin Unit Conference, Buffet, and Low Height Credenzas (Excludes 36" width)			
(1) 20" Depth Single Wood Frame Unit	Add -FWTF1	\$817	Located in the rightmost cabinet, applied to right door
(1) 24" Depth Double Wood Frame Unit	Add -FWTF2	\$1,225	Located in the rightmost cabinet, applied to right door
Dual Wood Frame Pull-Out Waste/Recycling Bin Unit Conference, Buffet, and Low Height Credenzas (Excludes 36"-54" width)			
(2) 20" Depth Single Wood Frame Units	Add -FWTF3	\$1,633	Located in the rightmost cabinet, applied to left and right doors
(2) 24" Depth Double Wood Frame Units	Add -FWTF4	\$2,450	Located in the rightmost cabinet, applied to left and right doors
24" Depth Single Pull-Out Drawer Refrigerator Available on Conference and Low Height Credenzas			
Pull-Out Drawer Refrigerator	Add -FWOM24	\$7,327	Located in left most cabinet, includes applied door panel

EDGE PROFILE



Square Edge

REQUIRED INFORMATION (ORDER CANNOT BE ENTERED WITHOUT THIS INFORMATION)

See appendix pages vi-viii for surface material options.

- Choose Door Style: Defaults to case finish, if none selected
- Choose Pull Style: Defaults to Push Latch, if none selected
- Choose Solid Surface Finish
- Choose Paint Finish, if specified
- Choose Veneer Finish, if specified

GENERAL INFORMATION

- Solid Surface tops are 1/2" thick
- When veneer case is specified, the case exterior is standard slip-match layup regardless of veneer door style selection
- Pull-Out Waste/Recycling Bin size: 17-7/8" x 8-3/32" x 11-9/16"; (1) 35 Qt.; Double Pull-Out Waste/Recycling Units include two bins
- Locks
 - Veneer (Case Only) - When lock option is specified, color will default to Satin Nickel
 - Painted (Case Only) - When lock option is specified, color will default based on Paint finish:
 - Aged Bronze, Black, Galaxy, Shadow, and Storm: Black
 - Cloud: White
 - Burnish, Foil, Satin Bronze: Satin Nickel
 - Chrome: Polished Nickel
- Credenzas include one adjustable shelf behind each door unless other components are specified
- Equipment racks hold 12RU and include a thermostatically controlled fan and plug strip



SOLID SURFACE TOP

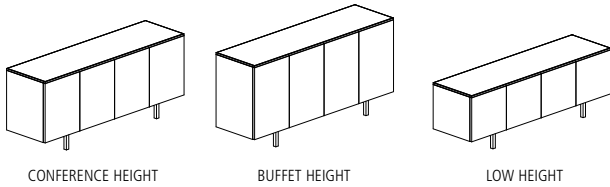

CASE MATERIAL KEY

PA-IB Painted Case with Inset Leg
 V-IB Veneer Case with Inset Leg

INSET LEG

MODEL #	W x D x H	DESCRIPTION	-PA-IB	-V-IB
CONFERENCE HEIGHT (23.5 IN. CASE WITH 6.5 IN. INSET LEG)				
FWLC-3629-SS	36 x 20 x 30.25	Two Doors	6,766	7,464
FWLC-5429-SS	54 x 20 x 30.25	Three Doors	8,661	9,575
FWLC-7229-SS	72 x 20 x 30.25	Four Doors	10,563	11,684
FWLC-9029-SS	90 x 20 x 30.25	Five Doors	12,464	13,799
FWLD-3629-SS	36 x 24 x 30.25	Two Doors	7,391	8,161
FWLD-5429-SS	54 x 24 x 30.25	Three Doors	9,482	10,487
FWLD-7229-SS	72 x 24 x 30.25	Four Doors	11,574	12,810
FWLD-9029-SS	90 x 24 x 30.25	Five Doors	13,667	15,136
BUFFET HEIGHT (28.5 IN. CASE WITH 6.5 IN. INSET LEG)				
FWCC-3636-SS	36 x 20 x 35.25	Two Doors	7,265	8,021
FWCC-5436-SS	54 x 20 x 35.25	Three Doors	9,320	10,304
FWCC-7236-SS	72 x 20 x 35.25	Four Doors	11,373	12,583
FWCC-9036-SS	90 x 20 x 35.25	Five Doors	13,427	14,866
FWCD-3636-SS	36 x 24 x 35.25	Two Doors	7,946	8,774
FWCD-5436-SS	54 x 24 x 35.25	Three Doors	10,204	11,288
FWCD-7236-SS	72 x 24 x 35.25	Four Doors	12,462	13,796
FWCD-9036-SS	90 x 24 x 35.25	Five Doors	14,722	16,307
LOW HEIGHT (17.5 IN. CASE WITH 6.5 IN. INSET LEG)				
FWWC-3624-SS	36 x 20 x 24.25	Two Doors	6,423	6,889
FWWC-5424-SS	54 x 20 x 24.25	Three Doors	8,219	8,831
FWWC-7224-SS	72 x 20 x 24.25	Four Doors	10,014	10,767
FWWC-9024-SS	90 x 20 x 24.25	Five Doors	11,812	12,706

DOOR STYLE

DESCRIPTION	CODE	NOTES	PRICE
Vertical Veneer	-VD		No Charge
Horizontal Veneer	-HD		No Charge
Veneer/Paint Combination	-VPD	Reference page 8 for predetermined accent door locations	No Charge
Painted	-PAD		No Charge

PULL STYLE

DESCRIPTION	CODE	NOTES	TWO DOOR	THREE DOOR	FOUR DOOR	FIVE DOOR
Push Latch	No Code	Push to open (no pull). Applied to all doors.	No Charge	No Charge	No Charge	No Charge
Handle Pull - Powder Coat	-HP	Pull to open. Applied to all doors.	\$157	\$236	\$314	\$392
Handle Pull - High Polish Finish	-HP-HPF	Pull to open. Applied to all doors.	\$277	\$416	\$554	\$693
Handle Pull - Clear Anodized	-HP-CA	Pull to open. Applied to all doors.	\$157	\$236	\$314	\$392
Handle Pull - Goldmatt Anodized	-HP-GMA	Pull to open. Applied to all doors.	\$230	\$345	\$460	\$575
Handle Pull - Antique Brass Anodized	-HP-ABA	Pull to open. Applied to all doors.	\$230	\$345	\$460	\$575
Handle Pull - Light Bronze Anodized	-HP-LBA	Pull to open. Applied to all doors.	\$230	\$345	\$460	\$575



SOLID SURFACE TOP

PUSH LATCH OR HANDLE PULL OPTIONS	CODE	PRICE	NOTES
Locks	Add -LK	\$315	Locks included in all cabinets
Polished Chrome Base	Add -PCIB	\$501	
Wire Frame Pull-Out Waste/Recycling Unit Conference and Buffet Height Credenzas (excludes 36" width)			
(1) 20" Depth Single Wire Frame Unit	Add -TF1	\$309	Located in the rightmost cabinet, behind the right door
(1) 24" Depth Double Wire Frame Unit	Add -TF2	\$477	Located in the rightmost cabinet, behind the right door
Dual Wire Frame Pull-Out Waste/Recycling Units Conference and Buffet Height Credenzas (Excludes 36"-54" width)			
(2) 20" Depth Single Wire Frame Units	Add -TF3	\$617	Located in the rightmost cabinet, behind left and right doors
(2) 24" Depth Double Wire Frame Units	Add -TF4	\$954	Located in the rightmost cabinet, behind left and right doors
24" Depth Equipment Rack Options Available on Buffet Height Credenzas			
Fixed Equipment Rack	Add -R2	\$947	Located in left most cabinet, behind left and right doors
Sliding Equipment Rack	Add -R1	\$3,467	Located in left most cabinet, behind left and right doors

ADDITIONAL HANDLE PULL OPTIONS

Wood Frame Pull-Out Waste/Recycling Bin Unit Conference and Buffet Height Credenzas (Excludes 36" width)			
(1) 20" Depth Single Wood Frame Unit	Add -FWTF1	\$817	Located in the rightmost cabinet, applied to right door
(1) 24" Depth Double Wood Frame Unit	Add -FWTF2	\$1,225	Located in the rightmost cabinet, applied to right door
Dual Wood Frame Pull-Out Waste/Recycling Bin Unit Conference and Buffet Height Credenzas (Excludes 36"-54" width)			
(2) 20" Depth Single Wood Frame Units	Add -FWTF3	\$1,633	Located in the rightmost cabinet, applied to left and right doors
(2) 24" Depth Double Wood Frame Units	Add -FWTF4	\$2,450	Located in the rightmost cabinet, applied to left and right doors
24" Depth Single Pull-Out Drawer Refrigerator Available on Conference and Buffet Height Credenzas			
Pull-Out Drawer Refrigerator	Add -FWOM24	\$7,327	Located in left most cabinet, includes applied door panel

EDGE PROFILE



Square Edge

REQUIRED INFORMATION (ORDER CANNOT BE ENTERED WITHOUT THIS INFORMATION)

See appendix pages vi-viii for surface material options.

- Choose Door Style: Defaults to case finish, if none selected
- Choose Pull Style: Defaults to Push Latch, if none selected
- Choose Metal Finish
- Choose Solid Surface Finish
- Choose Paint Finish, if specified
- Choose Veneer Finish, if specified

GENERAL INFORMATION

- Solid Surface tops are 1/2" thick
- When veneer case is specified, the case exterior is standard slip-match layout regardless of veneer door style selection
- Pull-Out Waste/Recycling Bin size: 17-7/8" x 8-3/32" x 11-9/16"; (1) 35 Qt.; Double Pull-Out Waste/Recycling Units include two bins
- When lock option is specified, color will default based on leg finish:
 - Aged Bronze, Black, Galaxy, Shadow, and Storm: Black
 - Cloud: White
 - Burnish, Foil, and Satin Bronze: Satin Nickel
 - Chrome: Polished Nickel
- Credenzas include one adjustable shelf behind each door unless other components are specified
- Equipment racks hold 12RU and include a thermostatically controlled fan and plug strip



SOLID SURFACE TOP

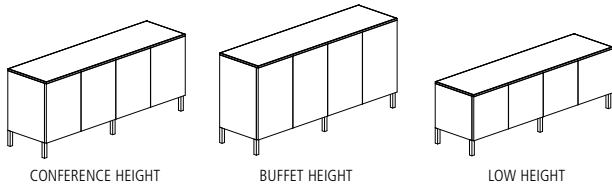

CASE MATERIAL KEY

PA-OB Painted Case with Edge-mount Post Leg
 V-OB Veneer Case with Edge-mount Post Leg

EDGE-MOUNT POST LEG

MODEL #	W x D x H	DESCRIPTION	-PA-OB	-V-OB
CONFERENCE HEIGHT (23.5 IN. CASE WITH 6.5 IN. EDGE-MOUNT POST LEG)				
FWLC-3629-SS	36 x 20 x 30.25	Two Door	6,766	7,464
FWLC-5429-SS	54 x 20 x 30.25	Three Door	8,661	9,575
FWLC-7229-SS	72 x 20 x 30.25	Four Door	10,563	11,684
FWLC-9029-SS	90 x 20 x 30.25	Five Door	12,464	13,799
FWLD-3629-SS	36 x 24 x 30.25	Two Door	7,391	8,161
FWLD-5429-SS	54 x 24 x 30.25	Three Door	9,482	10,487
FWLD-7229-SS	72 x 24 x 30.25	Four Door	11,574	12,810
FWLD-9029-SS	90 x 24 x 30.25	Five Door	13,667	15,136
BUFFET HEIGHT (28.5 IN. CASE WITH 6.5 IN. EDGE-MOUNT POST LEG)				
FWCC-3636-SS	36 x 20 x 35.25	Two Door	7,265	8,021
FWCC-5436-SS	54 x 20 x 35.25	Three Door	9,320	10,304
FWCC-7236-SS	72 x 20 x 35.25	Four Door	11,373	12,583
FWCC-9036-SS	90 x 20 x 35.25	Five Door	13,427	14,866
FWCD-3636-SS	36 x 24 x 35.25	Two Door	7,946	8,774
FWCD-5436-SS	54 x 24 x 35.25	Three Door	10,204	11,288
FWCD-7236-SS	72 x 24 x 35.25	Four Door	12,462	13,796
FWCD-9036-SS	90 x 24 x 35.25	Five Door	14,722	16,307
LOW HEIGHT (17.5 IN. CASE WITH 6.5 IN. EDGE-MOUNT POST LEG)				
FWWC-3624-SS	36 x 20 x 24.25	Two Door	6,423	6,889
FWWC-5424-SS	54 x 20 x 24.25	Three Door	8,219	8,831
FWWC-7224-SS	72 x 20 x 24.25	Four Door	10,014	10,767
FWWC-9024-SS	90 x 20 x 24.25	Five Door	11,812	12,706

DOOR STYLE

DESCRIPTION	CODE	NOTES	PRICE
Vertical Veneer	-VD		No Charge
Horizontal Veneer	-HD		No Charge
Veneer/Paint Combination	-VPD	Reference page 8 for predetermined accent door locations	No Charge
Painted	-PAD		No Charge

PULL STYLE

DESCRIPTION	CODE	NOTES	TWO DOOR	THREE DOOR	FOUR DOOR	FIVE DOOR
Push Latch	No Code	Push to open (no pull). Applied to all doors.	No Charge	No Charge	No Charge	No Charge
Handle Pull - Powder Coat	-HP	Pull to open. Applied to all doors.	\$157	\$236	\$314	\$392
Handle Pull - High Polish Finish	-HP-HPF	Pull to open. Applied to all doors.	\$277	\$416	\$554	\$693
Handle Pull - Clear Anodized	-HP-CA	Pull to open. Applied to all doors.	\$157	\$236	\$314	\$392
Handle Pull - Goldmatt Anodized	-HP-GMA	Pull to open. Applied to all doors.	\$230	\$345	\$460	\$575
Handle Pull - Antique Brass Anodized	-HP-ABA	Pull to open. Applied to all doors.	\$230	\$345	\$460	\$575
Handle Pull - Light Bronze Anodized	-HP-LBA	Pull to open. Applied to all doors.	\$230	\$345	\$460	\$575



SOLID SURFACE TOP

PUSH LATCH OR HANDLE PULL OPTIONS	CODE	PRICE	NOTES
Locks	Add -LK	\$315	Locks included in all cabinets
Polished Chrome Base	Add -PCOB	\$541	
Wire Frame Pull-Out Waste/Recycling Unit Conference and Buffet Height Credenzas (excludes 36" width)			
(1) 20" Depth Single Wire Frame Unit	Add -TF1	\$309	Located in the rightmost cabinet, behind the right door
(1) 24" Depth Double Wire Frame Unit	Add -TF2	\$477	Located in the rightmost cabinet, behind the right door
Dual Wire Frame Pull-Out Waste/Recycling Units Conference and Buffet Height Credenzas (Excludes 36"-54" width)			
(2) 20" Depth Single Wire Frame Units	Add -TF3	\$617	Located in the rightmost cabinet, behind left and right doors
(2) 24" Depth Double Wire Frame Units	Add -TF4	\$954	Located in the rightmost cabinet, behind left and right doors
24" Depth Equipment Rack Options Available on Buffet Height Credenzas			
Fixed Equipment Rack	Add -R2	\$947	Located in left most cabinet, behind left and right doors
Sliding Equipment Rack	Add -R1	\$3,467	Located in left most cabinet, behind left and right doors

ADDITIONAL HANDLE PULL OPTIONS

Wood Frame Pull-Out Waste/Recycling Bin Unit Conference and Buffet Height Credenzas (Excludes 36" width)			
(1) 20" Depth Single Wood Frame Unit	Add -FWTF1	\$817	Located in the rightmost cabinet, applied to right door
(1) 24" Depth Double Wood Frame Unit	Add -FWTF2	\$1,225	Located in the rightmost cabinet, applied to right door
Dual Wood Frame Pull-Out Waste/Recycling Bin Unit Conference and Buffet Height Credenzas (Excludes 36"-54" width)			
(2) 20" Depth Single Wood Frame Units	Add -FWTF3	\$1,633	Located in the rightmost cabinet, applied to left and right doors
(2) 24" Depth Double Wood Frame Units	Add -FWTF4	\$2,450	Located in the rightmost cabinet, applied to left and right doors
24" Depth Single Pull-Out Drawer Refrigerator Available on Conference and Buffet Height Credenzas			
Pull-Out Drawer Refrigerator	Add -FWOM24	\$7,327	Located in left most cabinet, includes applied door panel

EDGE PROFILE



Square Edge

REQUIRED INFORMATION (ORDER CANNOT BE ENTERED WITHOUT THIS INFORMATION)

See appendix pages vi-viii for surface material options.

- Choose Door Style: Defaults to case finish, if none selected
- Choose Pull Style: Defaults to Push Latch, if none selected
- Choose Metal Finish
- Choose Solid Surface Finish
- Choose Paint Finish, if specified
- Choose Veneer Finish, if specified

GENERAL INFORMATION

- Solid Surface tops are 1/2" thick
- When veneer case is specified, the case exterior is standard slip-match layout regardless of veneer door style selection
- Pull-Out Waste/Recycling Bin size: 17-7/8" x 8-3/32" x 11-9/16"; (1) 35 Qt.; Double Pull-Out Waste/Recycling Units include two bins
- When lock option is specified, color will default based on leg finish:
 - Aged Bronze, Black, Galaxy, Shadow, and Storm: Black
 - Cloud: White
 - Burnish, Foil, and Satin Bronze: Satin Nickel
 - Chrome: Polished Nickel
- Credenzas include one adjustable shelf behind each door unless other components are specified
- Equipment racks hold 12RU and include a thermostatically controlled fan and plug strip



SOLID SURFACE TOP

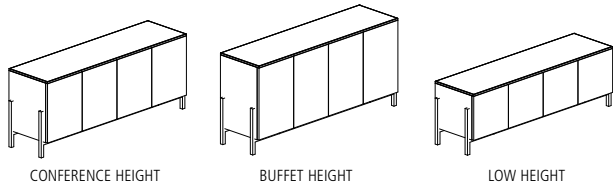

CASE MATERIAL KEY

PA-CB Painted Case with Cradle Base
 V-CB Veneer Case with Cradle Base

CRADLE BASE

MODEL #	W x D x H	DESCRIPTION	-PA-CB	-V-CB
CONFERENCE HEIGHT (23.5 IN. CASE WITH 6.5 IN. CRADLE BASE)				
FWLC-3629-SS	36 x 20 x 30.25	Two Doors	7,383	8,085
FWLC-5429-SS	54 x 20 x 30.25	Three Doors	9,282	10,194
FWLC-7229-SS	72 x 20 x 30.25	Four Doors	11,183	12,305
FWLC-9029-SS	90 x 20 x 30.25	Five Doors	13,086	14,420
FWLD-3629-SS	36 x 24 x 30.25	Two Doors	8,015	8,782
FWLD-5429-SS	54 x 24 x 30.25	Three Doors	10,104	11,108
FWLD-7229-SS	72 x 24 x 30.25	Four Doors	12,196	13,428
FWLD-9029-SS	90 x 24 x 30.25	Five Doors	14,289	15,755
BUFFET HEIGHT (28.5 IN. CASE WITH 6.5 IN. CRADLE BASE)				
FWCC-3636-SS	36 x 20 x 35.25	Two Doors	7,888	8,641
FWCC-5436-SS	54 x 20 x 35.25	Three Doors	9,942	10,923
FWCC-7236-SS	72 x 20 x 35.25	Four Doors	11,993	13,203
FWCC-9036-SS	90 x 20 x 35.25	Five Doors	14,047	15,484
FWCD-3636-SS	36 x 24 x 35.25	Two Doors	8,569	9,395
FWCD-5436-SS	54 x 24 x 35.25	Three Doors	10,824	11,907
FWCD-7236-SS	72 x 24 x 35.25	Four Doors	13,084	14,415
FWCD-9036-SS	90 x 24 x 35.25	Five Doors	15,343	16,925
LOW HEIGHT (17.5 IN. CASE WITH 6.5 IN. CRADLE BASE)				
FWWC-3624-SS	36 x 20 x 24.25	Two Doors	7,045	7,509
FWWC-5424-SS	54 x 20 x 24.25	Three Doors	8,842	9,450
FWWC-7224-SS	72 x 20 x 24.25	Four Doors	10,637	11,389
FWWC-9024-SS	90 x 20 x 24.25	Five Doors	12,433	13,328

DOOR STYLE

DESCRIPTION	CODE	NOTES	PRICE
Vertical Veneer	-VD		No Charge
Horizontal Veneer	-HD		No Charge
Veneer/Paint Combination	-VPD	Reference page 8 for predetermined accent door locations	No Charge
Painted	-PAD		No Charge

PULL STYLE

DESCRIPTION	CODE	NOTES	TWO DOOR	THREE DOOR	FOUR DOOR	FIVE DOOR
Push Latch	No Code	Push to open (no pull). Applied to all doors.	No Charge	No Charge	No Charge	No Charge
Handle Pull - Powder Coat	-HP	Pull to open. Applied to all doors.	\$157	\$236	\$314	\$392
Handle Pull - High Polish Finish	-HP-HPF	Pull to open. Applied to all doors.	\$277	\$416	\$554	\$693
Handle Pull - Clear Anodized	-HP-CA	Pull to open. Applied to all doors.	\$157	\$236	\$314	\$392
Handle Pull - Goldmatt Anodized	-HP-GMA	Pull to open. Applied to all doors.	\$230	\$345	\$460	\$575
Handle Pull - Antique Brass Anodized	-HP-ABA	Pull to open. Applied to all doors.	\$230	\$345	\$460	\$575
Handle Pull - Light Bronze Anodized	-HP-LBA	Pull to open. Applied to all doors.	\$230	\$345	\$460	\$575



SOLID SURFACE TOP

PUSH LATCH OR HANDLE PULL OPTIONS	CODE	PRICE	NOTES
Locks	Add -LK	\$315	Locks included in all cabinets
Polished Chrome Base	Add -PCCB	\$1,775	
Wire Frame Pull-Out Waste/Recycling Unit Conference and Buffet Height Credenzas (excludes 36" width)			
(1) 20" Depth Single Wire Frame Unit	Add -TF1	\$309	Located in the rightmost cabinet, behind the right door
(1) 24" Depth Double Wire Frame Unit	Add -TF2	\$477	Located in the rightmost cabinet, behind the right door
Dual Wire Frame Pull-Out Waste/Recycling Units Conference and Buffet Height Credenzas (Excludes 36"-54" width)			
(2) 20" Depth Single Wire Frame Units	Add -TF3	\$617	Located in the rightmost cabinet, behind left and right doors
(2) 24" Depth Double Wire Frame Units	Add -TF4	\$954	Located in the rightmost cabinet, behind left and right doors
24" Depth Equipment Rack Options Available on Buffet Height Credenzas			
Fixed Equipment Rack	Add -R2	\$947	Located in left most cabinet, behind left and right doors
Sliding Equipment Rack	Add -R1	\$3,467	Located in left most cabinet, behind left and right doors

ADDITIONAL HANDLE PULL OPTIONS

Wood Frame Pull-Out Waste/Recycling Bin Unit Conference and Buffet Height Credenzas (Excludes 36" width)			
(1) 20" Depth Single Wood Frame Unit	Add -FWTF1	\$817	Located in the rightmost cabinet, applied to right door
(1) 24" Depth Double Wood Frame Unit	Add -FWTF2	\$1,225	Located in the rightmost cabinet, applied to right door
Dual Wood Frame Pull-Out Waste/Recycling Bin Unit Conference and Buffet Height Credenzas (Excludes 36"-54" width)			
(2) 20" Depth Single Wood Frame Units	Add -FWTF3	\$1,633	Located in the rightmost cabinet, applied to left and right doors
(2) 24" Depth Double Wood Frame Units	Add -FWTF4	\$2,450	Located in the rightmost cabinet, applied to left and right doors
24" Depth Single Pull-Out Drawer Refrigerator Available on Conference and Buffet Height Credenzas			
Pull-Out Drawer Refrigerator	Add -FWOM24	\$7,327	Located in left most cabinet, includes applied door panel

REQUIRED INFORMATION (ORDER CANNOT BE ENTERED WITHOUT THIS INFORMATION)

See appendix pages vi-viii for surface material options.

- Choose Door Style: Defaults to case finish, if none selected
- Choose Pull Style: Defaults to Push Latch, if none selected
- Choose Metal Finish

EDGE PROFILE

- Choose Surface Finish
- Choose Paint Finish, if specified
- Choose Veneer Finish, if specified



Square Edge

GENERAL INFORMATION

- Solid Surface tops are 1/2" thick
- When veneer case is specified, the case exterior is standard slip-match layout regardless of veneer door style selection
- Pull-Out Waste/Recycling Bin size: 17-7/8" x 8-3/32" x 11-9/16"; (1) 35 Qt.; Double Pull-Out Waste/Recycling Units include two bins
- When lock option is specified, color will default based on leg finish:
 - Aged Bronze, Black, Galaxy, Shadow, and Storm: Black
 - Cloud: White
 - Burnish, Foil, and Satin Bronze: Satin Nickel
 - Chrome: Polished Nickel
- Credenzas include one adjustable shelf behind each door unless other components are specified
- Equipment racks hold 12RU and include a thermostatically controlled fan and plug strip



SOLID SURFACE TOP

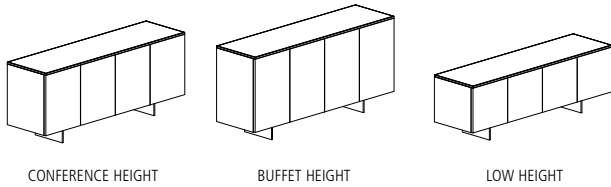

CASE MATERIAL KEY

PA-BB Painted Case with Blade Base
 V-BB Veneer Case with Blade Base

BLADE BASE

MODEL #	W x D x H	DESCRIPTION	-PA-BB	-V-BB
CONFERENCE HEIGHT (23.5 IN. CASE WITH 6 IN. BLADE BASE)				
FWLC-3629-SS	36 x 20 x 29.75	Two Doors	7,074	7,773
FWLC-5429-SS	54 x 20 x 29.75	Three Doors	8,973	9,882
FWLC-7229-SS	72 x 20 x 29.75	Four Doors	10,874	11,995
FWLC-9029-SS	90 x 20 x 29.75	Five Doors	12,777	14,109
FWLD-3629-SS	36 x 24 x 29.75	Two Doors	7,703	8,470
FWLD-5429-SS	54 x 24 x 29.75	Three Doors	9,793	10,797
FWLD-7229-SS	72 x 24 x 29.75	Four Doors	11,882	13,118
FWLD-9029-SS	90 x 24 x 29.75	Five Doors	13,977	15,445
BUFFET HEIGHT (28.5 IN. CASE WITH 6 IN. BLADE BASE)				
FWCC-3636-SS	36 x 20 x 34.75	Two Doors	7,577	8,329
FWCC-5436-SS	54 x 20 x 34.75	Three Doors	9,630	10,614
FWCC-7236-SS	72 x 20 x 34.75	Four Doors	11,683	12,895
FWCC-9036-SS	90 x 20 x 34.75	Five Doors	13,737	15,176
FWCD-3636-SS	36 x 24 x 34.75	Two Doors	8,258	9,084
FWCD-5436-SS	54 x 24 x 34.75	Three Doors	10,517	11,597
FWCD-7236-SS	72 x 24 x 34.75	Four Doors	12,775	14,104
FWCD-9036-SS	90 x 24 x 34.75	Five Doors	15,034	16,615
LOW HEIGHT (17.5 IN. CASE WITH 6 IN. BLADE BASE)				
FWWC-3624-SS	36 x 20 x 23.75	Two Doors	6,733	7,198
FWWC-5424-SS	54 x 20 x 23.75	Three Doors	8,531	9,143
FWWC-7224-SS	72 x 20 x 23.75	Four Doors	10,324	11,077
FWWC-9024-SS	90 x 20 x 23.75	Five Doors	12,124	13,015

DOOR STYLE

DESCRIPTION	CODE	NOTES	PRICE
Vertical Veneer	-VD		No Charge
Horizontal Veneer	-HD		No Charge
Veneer/Paint Combination	-VPD	Reference page 8 for predetermined accent door locations	No Charge
Painted	-PAD		No Charge

PULL STYLE

DESCRIPTION	CODE	NOTES	TWO DOOR	THREE DOOR	FOUR DOOR	FIVE DOOR
Push Latch	No Code	Push to open (no pull). Applied to all doors.	No Charge	No Charge	No Charge	No Charge
Handle Pull - Powder Coat	-HP	Pull to open. Applied to all doors.	\$157	\$236	\$314	\$392
Handle Pull - High Polish Finish	-HP-HPF	Pull to open. Applied to all doors.	\$277	\$416	\$554	\$693
Handle Pull - Clear Anodized	-HP-CA	Pull to open. Applied to all doors.	\$157	\$236	\$314	\$392
Handle Pull - Goldmatt Anodized	-HP-GMA	Pull to open. Applied to all doors.	\$230	\$345	\$460	\$575
Handle Pull - Antique Brass Anodized	-HP-ABA	Pull to open. Applied to all doors.	\$230	\$345	\$460	\$575
Handle Pull - Light Bronze Anodized	-HP-LBA	Pull to open. Applied to all doors.	\$230	\$345	\$460	\$575



SOLID SURFACE TOP

PUSH LATCH OR HANDLE PULL OPTIONS	CODE	PRICE	NOTES
Locks	Add -LK	\$315	Locks included in all cabinets
Polished Chrome Base	Add -PCBB	\$501	
Wire Frame Pull-Out Waste/Recycling Unit Conference and Buffet Height Credenzas (excludes 36" width)			
(1) 20" Depth Single Wire Frame Unit	Add -TF1	\$309	Located in the rightmost cabinet, behind the right door
(1) 24" Depth Double Wire Frame Unit	Add -TF2	\$477	Located in the rightmost cabinet, behind the right door
Dual Wire Frame Pull-Out Waste/Recycling Units Conference and Buffet Height Credenzas (Excludes 36"-54" width)			
(2) 20" Depth Single Wire Frame Units	Add -TF3	\$617	Located in the rightmost cabinet, behind left and right doors
(2) 24" Depth Double Wire Frame Units	Add -TF4	\$954	Located in the rightmost cabinet, behind left and right doors
24" Depth Equipment Rack Options Available on Buffet Height Credenzas			
Fixed Equipment Rack	Add -R2	\$947	Located in left most cabinet, behind left and right doors
Sliding Equipment Rack	Add -R1	\$3,467	Located in left most cabinet, behind left and right doors

ADDITIONAL HANDLE PULL OPTIONS

Wood Frame Pull-Out Waste/Recycling Bin Unit Conference and Buffet Height Credenzas (Excludes 36" width)			
(1) 20" Depth Single Wood Frame Unit	Add -FWTF1	\$817	Located in the rightmost cabinet, applied to right door
(1) 24" Depth Double Wood Frame Unit	Add -FWTF2	\$1,225	Located in the rightmost cabinet, applied to right door
Dual Wood Frame Pull-Out Waste/Recycling Bin Unit Conference and Buffet Height Credenzas (Excludes 36"-54" width)			
(2) 20" Depth Single Wood Frame Units	Add -FWTF3	\$1,633	Located in the rightmost cabinet, applied to left and right doors
(2) 24" Depth Double Wood Frame Units	Add -FWTF4	\$2,450	Located in the rightmost cabinet, applied to left and right doors
24" Depth Single Pull-Out Drawer Refrigerator Available on Conference and Buffet Height Credenzas			
Pull-Out Drawer Refrigerator	Add -FWOM24	\$7,327	Located in left most cabinet, includes applied door panel

EDGE PROFILE



Square Edge

REQUIRED INFORMATION (ORDER CANNOT BE ENTERED WITHOUT THIS INFORMATION)

See appendix pages vi-viii for surface material options.

- Choose Door Style: Defaults to case finish, if none selected
- Choose Pull Style: Defaults to Push Latch, if none selected
- Choose Metal Finish
- Choose Solid Surface Finish
- Choose Paint Finish, if specified
- Choose Veneer Finish, if specified

GENERAL INFORMATION

- Solid Surface tops are 1/2" thick
- When veneer case is specified, the case exterior is standard slip-match layout regardless of veneer door style selection
- Pull-Out Waste/Recycling Bin size: 17-7/8" x 8-3/32" x 11-9/16"; (1) 35 Qt.; Double Pull-Out Waste/Recycling Units include two bins
- When lock option is specified, color will default based on leg finish:
 - Aged Bronze, Black, Galaxy, Shadow, and Storm: Black
 - Cloud: White
 - Burnish, Foil, and Satin Bronze: Satin Nickel
 - Chrome: Polished Nickel
- Credenzas include one adjustable shelf behind each door unless other components are specified
- Equipment racks hold 12RU and include a thermostatically controlled fan and plug strip



Appendix



This price book supercedes all previous versions.

Before placing your order, confirm you have all required information necessary. Lead times for orders begin after all required information is included and correct.

Delivery Information

We know lead times are important and sticking to them even more so. We work to maintain a 6-8 week lead time on all standard products in this book from receipt of a clean order. All orders are acknowledged with an approximate shipping date and will be invoiced with the price in effect at the date the purchase order is received. For current lead times, please review www.nucraft.com/resources/lead-times.

Shipping charges are prepaid (within the continental U.S.). Therefore, pricing is a delivered price based on normal ground transportation. If you have special instructions, need to ship by air, or are shipping to Alaska or Hawaii, contact Nucraft Customer Service. Nucraft can also help arrange to have products blanket wrapped for an additional charge. Contact the Nucraft Customer Service team or specify it on your purchase order.

Minimum Freight Charge: Any order below \$3,000 net will be assessed a \$500 net minimum freight charge (one per order).

Orders are subject to acquiring the materials required for manufacturing. Fulfillment can be affected by strikes, fires, embargoes and acts of government. These elements are beyond our control.

Nucraft offers a variety of services to accommodate a wide range of delivery requirements. Availability of these services is dependent on a number of factors and may not be offered with all shipments. Examples of delivery services that have additional fees include:

- Specific date
- Specific time of day, morning or afternoon
- Delivery to a warehouse before delivery to its final destination (unless product is picked up at the warehouse)

Contact the Nucraft Customer Service team for availability and pricing on these services.

Freight Terms

Shipping charges for Nucraft products are prepaid for standard delivery in the continental United States. Standard delivery is defined as follows: Product is delivered on a 53' trailer being pulled by a long-haul tractor (total length of 85'). Facility will receive delivery Monday through Friday between the hours of 8:00 AM and 4:00 PM. Facility has docks with levelers and a fork truck for unloading. Product will be loaded on load bars two levels high. Receiving facility is responsible to have personnel on hand to unload the truck upon arrival, drivers do not unload. Delivery sites or times that do not meet these criteria may be accommodated, but will incur a charge to cover additional shipping costs. Please **notify Nucraft a minimum of two weeks prior to shipment** to arrange special services and determine additional charges.

Storage

Nucraft has no storage facilities for finished product. If a customer cannot accept an order when it is ready for shipment, the customer must designate an alternative shipping address. If no address is provided, Nucraft may, at its discretion, transfer the product to storage. If product is transferred to an off-site storage facility, the customer may be charged for transportation to the facility and for any associated storage fees. Nucraft considers transfer of the product to a storage facility the equivalent of shipment, including invoicing and payment. Customers assume the risk of damage or loss during storage.

Transportation Times and Delays

Third party carriers that Nucraft contracts with will make reasonable efforts to accommodate requested delivery times and dates. Scheduled delivery appointments may, however, be delayed for a variety of reasons, including inclement weather, traffic, transportation equipment problems, and delays encountered at other delivery locations along the delivery route. Nucraft does not recommend scheduling activities that depend on the delivery appointment (for example, scheduling furniture installers to install furniture the day of the delivery appointment). Nucraft shall not be liable for any costs incurred as a result of a missed delivery appointment.

Shipment Damage Claims

Legal title to merchandise passes to the buyer upon acceptance by the carrier. Inspect all cartons upon delivery. Details of visible damage should be noted on the delivery receipt. Do not destroy packaging, transport to site, or install product if damage is found upon inspection. Inspection of products should be completed upon delivery to the receiver. If visible damage is apparent, a claim should be filed immediately with Nucraft Customer Service. If visible damage is not apparent, sign the delivery receipt "No visible damage." This will allow recourse for a concealed damage claim. Concealed damage claims must be filed within 15 days of receipt, **prior to transporting or installing any product.**

Do not destroy packing materials until shipment has been inspected. If damage is found, proceed to file a claim with Nucraft Customer Service.

Failure to make any claims against Nucraft within 15 days shall constitute acceptance of the merchandise and a waiver of any defects, errors or shortages discovered upon inspection.

Cancellations

Cancellations must be reviewed by our Customer Service team. Because we build your products to order, orders cannot be cancelled once processing has begun. Processing includes but is not limited to development of shop drawings and other engineering drawings. If cancellation is approved, a processing fee of 20-100% will be assessed based on the status of the order.

Change Order Policy

Nucraft will make every attempt to honor any reasonable change request to product provided that the request is received prior to start of production. Change orders will be accepted only if the request is made in writing and received in time to make the change. Nucraft reserves the right to increase our acknowledged price and ship date if necessary to make the requested changes. Please submit any change order request to our Customer Service team. Nucraft will assess charges to the customer as stipulated in the following:

- Standard Orders: Change orders received prior to production will be charged \$400 net to cover administrative costs.
- Special Orders: Change orders received prior to production will be charged \$400 net to cover administrative costs. There may be additional costs associated with engineering labor required for the change order.
- Change orders received after production must be evaluated by Nucraft. If approved, the charge will be \$400 net plus any restocking charges accumulated. There may be additional costs associated with engineering and/or manufacturing labor, as well as material costs, required for the change order.



Repair Authorization

Prior written approval is required for repairs of merchandise charged to Nucraft. Failure to do so will result in customer funded repairs.

Payment Terms

Deposits are required at the time of order due to the custom nature of our products. See information regarding Cancellations above.

Credit terms are available to qualified customers. Please contact AR@Nucraft.com to start the application process. Note that the credit application process requires a valid sales tax exemption or resale tax certificate, Form W-9, and three current trade references.

Credit Card Payments are accepted via web portal. Please contact AR@Nucraft.com for payment instructions. Note that a 2% convenience fee will be added for using this payment method and no early pay discounts are allowed on credit card payments.

Warranty

Nucraft Furniture is warranted to be free from defects in materials and workmanship for a period of ten years of single shift use. Limitations include:

- Mechanical Devices such as latches, casters, and other moving components are warranted for five years of the date of original delivery.
- Height adjustable components are warranted for two years of the date of original delivery.
- The following are warranted for one year of the date of original delivery:
 - Textiles
 - Electrical Components
 - Refrigeration Units
 - Custom Products not described in Nucraft's Catalogue

This warranty is applicable only if furniture is properly installed and maintained in an office environment. This warranty extends only to products manufactured and sold in North America and only to original purchasers acquiring new Nucraft product through authorized dealers or approved sellers.

During this warranty period, Nucraft's sole obligation is to repair or replace, at Nucraft's discretion, products which prove to be defective during the warranty period.

This warranty does not cover:

- Damage caused by a carrier.
- Damage from user modification, misuse, abuse, accident, or negligence.
- Customer's Own Material (COM) specified by the customer that is not a standard product offering.
- Color, grain, or texture of wood and other covering material.

Nucraft extends no other warranties, expressed or implied, including warranty of merchantability or fitness for a particular purpose. Nucraft shall not be liable for loss of time, inconvenience, commercial loss, incidental or consequential damages.

Environmental Statement

Nucraft is committed to supporting responsible environmental policies and practices in all that we do. We strive for sustainability, weighing our business decisions against the costs to the ecological, social and economic systems they affect.

Our products are manufactured to meet the credit requirements of the U.S. Green Building Council's LEED rating systems in one or more of the following categories:

- Recycled Content
- Certified Wood
- Low-Emitting Materials

Computer Aided Planning

Nucraft products and pricing are available via CET and 2020 Worksheet, an AutoCAD®-based space planning tool.

2020 Worksheet is an integrated software system developed specifically for interior designers and facility planners to enhance workplace performance. This modern suite of applications works together seamlessly, in concert. Navigate catalogs, select products, design in plan view and 3D, assign options, create worksheets and build a project where you want, when you want. Take your pick. It's dynamic and interactive. Design projects are a work in progress. And now you can perform any of the many discrete tasks that go into a project any time, any place.

Product symbols (Revit, 2D and 3D) are available on the Nucraft website at www.nucraft.com/resources/designer-tools/product-symbols.

iSpec®

Nucraft offers a free online product configuration and specification service that saves you time and allows you to be creative while leaving the nuts and bolts to someone else. No specific software is required, nor is there any learning curve. This service applies to all Nucraft products. For additional information, visit www.nucraft.com/resources/designer-tools/ispec.



Surface Materials Palette

We crafted our materials palette using the same demanding standards that distinguish our furniture. Thoughtful design and attention to every detail elevate your possibilities.

Anchored by Nucraft veneers, unrivaled for clarity, quality, and depth of finish, our collection of surface materials comprises a sophisticated set of balanced elements that supports your design vision.

Some elements have their roots in Nucraft's rich heritage. Others are new materials and reflect current trends and taste. Together, they ensure that you're ready for today and positioned well for the future. Beautifully.

Custom Finishes

Nucraft specializes in expert custom finish matching. For a nominal upcharge we can provide custom finishes, and we are frequently asked to match the finishes of other furniture manufacturers. For finishes that appear unusual to match or for customers directly requesting a sample, a finish sample will be sent for approval prior to entering the order.

Custom finishes requiring colored varnishes to create a painted look can only be applied to Maple veneer and require one extra week in addition to the standard lead time. Nucraft's standard black finish (G82) can be applied to all Nucraft standard veneers. Walnut is the standard black veneer. Other species must be specified when ordering.

Clear coat on a special veneer requires an approved sample.

Custom finishes carry a 10% upcharge per item, per finish, capped at \$2,200 List.

Custom finish upcharges are not applied to any item that is not wood. Example: casters, ganging connectors, power options..

Treatments

Note: Default veneer sheen will vary per finish and product. Default finish is bolded on appendix pages vi-viii. If no direction is provided on incoming orders, default sheen will be selected. In addition, default veneer cut is noted in the price list. If no direction is provided on incoming orders, default cut will be selected.

Gloss: Gloss is a durable finish that tends to nicely mask normal wear and leaves wood grain visible to the eye. It achieves a medium gloss open pore appearance (40 – 50 sheen range). Finish numbers preceded by the letter "G" indicate a Gloss finish.

Matte: Like Gloss, Matte is durable, tends to nicely mask normal wear and leaves wood grain visible to the eye. It achieves a low luster, open pore appearance (10 – 20 sheen range). Finish numbers preceded by the letter "M" indicate a Matte finish.

Since each veneer type responds differently to both types of treatment, all will have a distinctive look and feel when finished. For example, a Walnut veneer with a Gloss treatment will remain much more textured than a Cherry veneer with the same treatment.

About the Wood

All Nucraft veneers are carefully selected for uniformity of color and grain. Still, wood is a natural substance and minor variations may occur due to its own uniqueness. Because of this, the furniture you receive may not be an exact match to our samples.

Nucraft takes great pride in our finish color consistency. However, wood is a natural product that will have color variation within a single piece of furniture, as well as from one piece to the next. Other factors also affect color over time, such as exposure to light (both intensity and duration). For example, lighter finishes cause more variation in colors over time.

In cases where a returning customer wants a precise match with existing furniture, we recommend sending a sample of the existing furniture finish. Please contact Nucraft Customer Service to determine an appropriate sample. This will ensure a finish match between old and new orders. This type of order is considered a control sample. There will be a 10% upcharge on an order of this type. Due to natural aging of veneers, natural finishes may vary.

Care and Maintenance of Wood Finishes

Our finish material is a crystal clear, urethane acrylic blend. This type of finish may be repaired in the field by a qualified refinisher.

Nucraft recommends using a damp cloth to clean your fine wood furniture. Always wipe with the grain of the wood. Should your wood furniture require a more thorough cleaning, we recommend using a mild cleaner such as Joy dish soap or Murphy's oil soap, thoroughly diluted in water (one part soap to thirty parts water). Water will not damage Nucraft's finish, but it may leave surface spots when it dries. To avoid this, dry the surface with a soft cloth after it is cleaned. Marks that cannot be removed with the cleaning methods above may be able to be removed using naphtha, a mild degreasing solvent.

Caution: while the use of polishes that contain wax, petroleum solvents or silicones may immediately enhance the "shine" of a product, it may also eventually remove the fine original finish applied in our factory. Silicone on the surface of wood may also make it very difficult to respray or refinish.

All Nucraft furniture is inspected and polished before it leaves our factory. In some instances, the packing materials may imprint on the factory polish. Cleaning and polishing the furniture once it is unpacked will normally restore the furniture to its original beauty.

In some cases, the rubber support feet used on the bottom of common office equipment (teleconferencing phones, laptops, microphones, copiers, etc.) can create unsightly marks in the surface of wood tops, due to oxidation of the lacquer finish. We suggest these machines be placed on a protective type of padding, such as felt.

Wood will fade as a result of exposure to UV light. This is particularly prevalent with light finishes. If color changes due to fading are a concern for your application, the impact can be minimized by selecting medium to dark stains for your wood surfaces. Our top coat includes a UV inhibitor which makes the finishes less prone to fading.



Laminates

Selected Formica®, Nevamar®, and Wilsonart® laminates are available on Training Tables, Conference Tables, Conference Room Furniture and select Occasional Tables. For standard laminate and wood pricing, refer to individual item pricing columns. It is important to note that wood grain laminates are unable to be grain matched over multi-piece table top applications.

Non-Standard Laminates

To order a color other than those on our list (see appendix page vi), refer to Nevamar or Formica standard grade, matte texture laminate offerings and Forbo Furniture Linoleums (excluding manufacturers' non-standard matte offering).

Nucraft can support other laminate and linoleum options beyond what can be found as standard options on appendix pages vi-viii. For pricing, please send a request to quotes@nucraft.com.

Care and Maintenance of Laminate

Laminate and Novawrap surfaces may be cleaned with a damp cloth and ordinary soap or non-abrasive household liquid detergent. Dry the surface with a clean cloth or soft paper towel to prevent streaks from appearing.

Care and Maintenance of Metal

Metal surfaces can be wiped with a damp cloth and rubbed dry. A mild non-abrasive household liquid detergent can be used if necessary. Regular maintenance of metal components, including tightening of fasteners and light lubrication of moving parts, will extend the life of your furniture.

Satin Etched Glass

Glass color may vary slightly on multi-piece conference table tops over 180" x 60" when satin etched glass is specified due to the iron content and etching process of the glass.

Care and Maintenance of Glass

Clear or frosted glass may be cleaned with commercial glass cleaner. Be sure to use a lint-free cloth if cleaning the frosted side of the glass.

Stone and Solid Surface Material

Despite its reputation for durability, natural stone can easily be broken during handling and/or installation if proper techniques are not followed. In addition, Nucraft is not responsible for the installation of natural stone or solid surface materials on its products. Therefore, installers specifically trained in the installation of these materials must be utilized to ensure a quality installation. Nucraft shall not be liable for any damages incurred during the handling and/or installation of natural stone or solid surface materials on its products.

Care and Maintenance of Granite

Granite surfaces may be cleaned with a damp cloth and ordinary soap or non-abrasive household liquid detergent. Dry the surface with a clean cloth or soft paper towel to prevent streaks from appearing.

Care and Maintenance of Leather

Genuine leather requires very little care. Nucraft recommends that leather be dusted regularly. If a more thorough cleaning is needed, use lukewarm water and a mild, non-abrasive soap. Generate some lather and lightly rub the surface with cheesecloth. Rinse off any soap film with clean water and towel dry. The leather may dry dull. To restore the leather to a normal gloss, rub it with a clean towel. Never use furniture polish, oil, varnish or ammonia. Saddle soap may be used to prevent the leather from becoming brittle or cracked and to maintain the original supple finish.

Touch Up Finish Kits

Model #	Description	Price
KIT-M	Metal Kit	85
KIT-P	Paint Kit	85
KIT-S	Stain Kit	85

REQUIRED INFORMATION:

(ORDER CANNOT BE ENTERED WITHOUT THIS INFORMATION)

- Kit model number
- Quantity of kits
- Specify finish (See appendix page vi)

General Information:

- Touch-up kits must be ordered on a purchase order separate from Nucraft product due to Hazmat shipping

Retrofit & Replacements

If needing a partial placement or retrofit solution, please reach out to our quote team. Grain/color matched in a set.



VENEER

STANDARD

Default veneer sheen will vary per finish and were determined by a team of experts who reviewed the colorways to determine if gloss or matte best highlighted the natural characteristics of the species of wood and the color of the stain. Default finish is bolded. If no direction is provided, default sheen will be selected.

	Matte	Gloss
Rift Cut Oak		
Carbon	M03	G03
Flat Cut Oak		
Artisan	M68	G68
Coco	M67	G67
Dove	M66	G66
Dune	M05	G05
Midnight	M69	G69
Portobello	M7413	G7413
Winter	M70	G70
Flaky Oak		
Sahara	M61	G61
Cherry		
Auburn	M93	G93
Cognac	M21	G21
Walnut		
Marron	M35	G35
Mocha	M33	G33
Onyx	M82	G82
Otter	M31	G31
Zinc	M30	G30
Maple		
Natural Maple	M60	G60
Linea		
Euro Birch Linea	M09	G09
Oak Linea	M08	G08
Silver Birch Linea	M10	G10
Walnut Linea	M27	G27
Paldao		
Canyon	M77	G77
Paldao	M76	G76
Thicket	M75	G75

LAMINATE

Coordinating wood finish and edgeband options listed below.

		Solid Edgeband	
Solid Laminates			
Formica Brite White	459-58	R01	
Formica Dover White	7197-58	R01	
Formica Folkstone	927-58	R03	
Formica Graphite	837-58	R05	
Formica Graystone	464-58	R02	
Formica Pearl	934-58	R02	
Patterned Laminates			
Nevamar Calm Distinction	VA6001T	R05	
Nevamar Cool Chic	VA7002T	R02	
Nevamar Easy Elegance	VA5002T	R05	
Nevamar Serene Stardom	VA5001T	R05	
Wilsonart Sheer Mesh	4876-38	R02	
Wilsonart Grey Mesh	4877-38	R02	
Wilsonart Pewter Mesh	4878-38	R05	
Wood Grain Laminates			
		Wood Finish	Woodgrain Edgeband
Formica Aged Ash	8844-58	M8844	R8844
Formica Blackened Legno	8848-58	M8848	R8848
Formica Bleached Legno	8845-58	M8845	R8845
Formica Chestnut Woodline	5884-58	M5884	R5884
Formica Espresso Pear	5489-58	M5489	R5489
Formica Natural Ash	8843-58	M8843	R8843
Formica Oiled Legno	8846-58	M8846	R8846
Formica Pecan Woodline	5883-58	M5883	R5883
Formica Planked Coffee Oak	7413-58	M7413	F7413
Formica Sand Maple	9237-58	G60	W7909
Formica Smoky Brown Pear	5488-58	M5488	R5488
Formica Thermo Walnut	6402-58	M6402	R6402
Formica Urban Planked Oak	9312-58	M9312	R9312
Formica Weathered Ash	8842-58	M8842	R8842
Formica White Ash	8841-58	M8841	R8841

GLASS

	Satin	Gloss
Satin or Gloss Glass		
Black	BS	-
Clove	VS	VG
Meringue	MS	MG
Moonlight	MLS	MLG
Storm	STS	STG
Quill	QS	QG
White	WS	WG



STONE

Stone orders may affect lead times. Standard Cambria finish is polished. For alternative finish options, please contact Nucraft Customer Service.

Stone	Subtop Paint	
Absolute Black Honed Granite	ST01	S8007
Carrara Marble	ST16	S8004

Quartz | Cambria® Signature

Ainsley	STC100	S8004
Armitage	STC101	S44
Avalene	STC192	S8004
Bellingham	STC102	S8004
Berkeley	STC103	S8004
Berwyn	STC104	S8004
Blackbrook	STC105	S44
Bradshaw	STC106	S8004
Bradwell	STC107	S8004
Cambria Black	STC109	S44
Carrick	STC110	S44
Charlestown	STC207	S44
Charston	STC208	S44
Clifton	STC112	S8004
Colton	STC113	S8004
Copeland	STC200	S8004
Crowndale	STC114	S8004
Devon	STC115	S44
Dovestone	STC209	S8004
Fairbourne	STC116	S8004
Fieldstone	STC117	S44
Hadley	STC201	S44
Halewood	STC119	S8004
Hermitage	STC120	S8004
Kendal	STC122	S8004
Laneshaw	STC124	S44
MacBeth	STC202	S8004
Malvern	STC125	S8004
Montgomery	STC128	S8004
New Quay	STC130	S8004
Pendle Hill	STC131	S8004
Praa Sands	STC132	S8004
Ridgegate	STC203	S8004
Rose Bay	STC133	S8004
Sandgate	STC135	S8004
Seacourt	STC204	S8004
Smithfield	STC136	S8004
Sutherland	STC138	S8004
Swanbridge	STC139	S8004
Torquay	STC140	S8004
Trafalgar	STC205	S8004
Travella	STC141	S8004
Weybourne	STC143	S8004
Whitendale	STC206	S8004
Whitney	STC144	S8004
Woodcroft	STC146	S44

Quartz | Cambria® Luxury

Abbey	STC147	S8004
Annicca	STC148	S8004
Beckington	STC150	S8004
Bentley	STC151	S8004
Brighton	STC212	S8004
Brittanica	STC153	S8004
Brittanica Gold Cool	STC154	S8004
Brittanica Gold Warm	STC155	S8004
Brittanica Warm	STC156	S8004
Claremont	STC215	S8004
Clovelly	STC158	S8004
Delamere	STC159	S44
Delgatie	STC160	S8004
Ella	STC161	S8004
Everleigh	STC162	S8004
Everleigh Warm	STC191	S8004
Gladstone	STC163	S8004
Golden Dragon	STC164	S44
Hailey	STC165	S8004
Harlow	STC166	S8004
Hemsworth	STC167	S8004
Huntley	STC168	S8004
Inverness Blakeley	STC190	S8004
Inverness Bristol Bay	STC169	S8004
Inverness Bronze	STC170	S8004
Inverness Cobalt	STC171	S8004
Inverness Everleigh	STC172	S8004
Inverness Frost	STC196	S8004
Inverness Gold	STC197	S8004
Inverness Platinum	STC173	S8004
Inverness Swansea	STC174	S8004
Ironsbridge	STC175	S8004
Iverness Frost	STC176	S8004
Iverness Gold	STC177	S8004
Kenwood	STC216	S8004
Lakedale	STC179	S8004
Mayfair	STC181	S8004
Mersey	STC182	S44
Notting Hill	STC183	S8004
Oakleigh	STC184	S8004
Portrush	STC185	S8004
Queen Anne	STC186	S8006
Skara Brae	STC187	S8004
Southport	STC188	S8004
White Cliff	STC189	S8004



Quartz | Cambria® Coordinates

Big Sur Mist	STC221	S8004
Black Rock	STC223	S44
Foggy City	STC220	S8004
Mammoth Cave	STC222	S44
Minnesota Snow	STC219	S8004
Salt Lake	STC218	S8004
St. Isley	STC213	S8004
Traymore Bay	STC214	S8004

Quartz | Wilsonart

Carrara Codena	ST21	S8004
Serene	ST17	S8004

SOLID SURFACE

Wilsonart Designer White	ST11
--------------------------	------

FENIX

Bianco Kos	J0032
Castoro Ottawa	J0717
Grigio Bromo	J0724
Grigio Efeso	J0725
Grigio Londra	J0718
Nero Ingo	J0720

METAL

Powder Coat

Aged Bronze	A8010
Black	A44
Burnished	A8009
Cloud	A8004
Foil	A8006
Galaxy	A8007
Moonlight	A87
Satin Bronze	A8011
Shadow	A8005
Storm	A8012

Metal

Antique Brass Anodized*	ABA
Clear Anodized	CA
Extra Light Bronze Anodized*	LBA
Goldmatt Anodized*	GMA
High Polish Finish	(upcharge applies) HPF
Polished Chrome	(upcharge applies) PC

*Available on pulls only

PAINT

Paint to Match Powder Coat

Aged Bronze	S8010
Black	S44
Burnished	S88
Cloud	S8004
Foil	S8006
Galaxy	S8007
Moonlight	S87
Nero Ingo	S0720
Satin Bronze	S8011
Shadow	S8005
Storm	S8012

Paint to Match Fenix

Bianco Kos	S0032
Castoro Ottawa	S0717
Grigio Bromo	S0724
Grigio Efeso	S0725
Grigio Londra	S0718
Nero Ingo	S0720

Paint to Match

To request a custom paint color, contact Nucraft Customer Service.

A paint sample must be matched and approved prior to order.