

SABER[®]

Planning Guide + Price List

QUICK LINKS

[PLANNING GUIDE](#)

[SABER PRICING](#)

[POWER AND DATA OPTIONS](#)

[GENERAL INFORMATION](#)

[FINISH INFORMATION](#)

[SURFACE MATERIALS](#)



TABLE OF CONTENTS

Click the shortcuts below to jump to each section.

General Information	ii-iii
Finish Information	iv-v
Surface Materials	vi-vii
Statement of Line	3
Planning Guide	4-20
Saber Round Tables	21-22
Saber Rectangle and Boat Tables	23-24
Power and Data Options	25-32

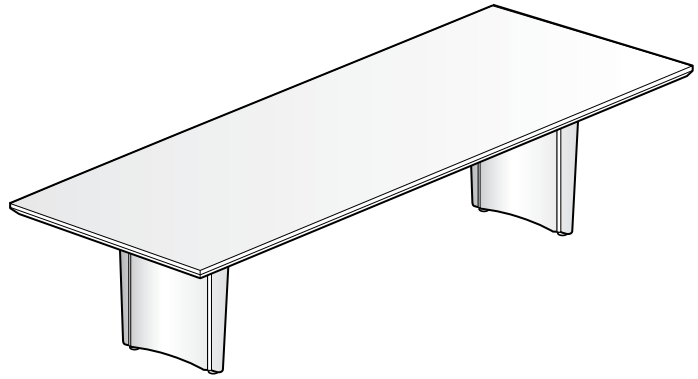



STATEMENT OF LINE

TOPS

Pages 21-24



Round

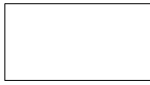

Rectangle

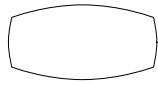

Boat

BASES

Pages 21-24

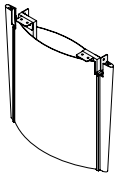

Panel Base

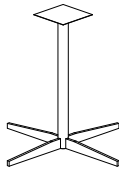

Metal X-Base

POWER OPTION - TOP SHAPE AND BASE STYLE AVAILABILITY

OPTION	ROUND**	RECTANGLE	BOAT
Perimeter Power*		•	•
Power Matrix	•	•	•
Tech Node	•	•	•
Round Grommet	•	•	•

*Only available on 96" or longer tops.

** Only available with Concave Column base

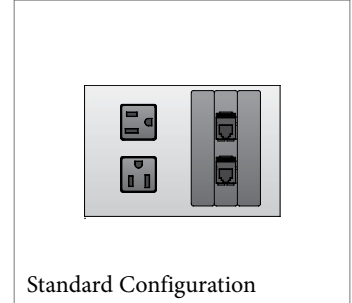
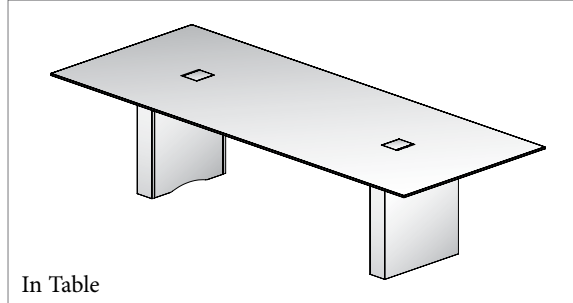

TABLE TOP POWER OPTION: POWER MATRIX

Available in a variety of sizes, styles and connectivity options, Power Matrix is Nucraft’s most versatile power option. Power Matrix incorporates a broad array of scalable features and is available across multiple product lines, making it the “go to” solution for power and AV connectivity needs.

Offered in four sizes and two door configurations (single and double), Power Matrix can handle any power and AV connectivity need, from the simplest to the most demanding.

Small



Medium

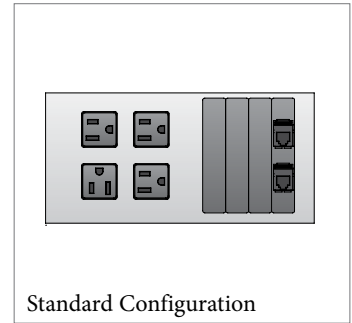
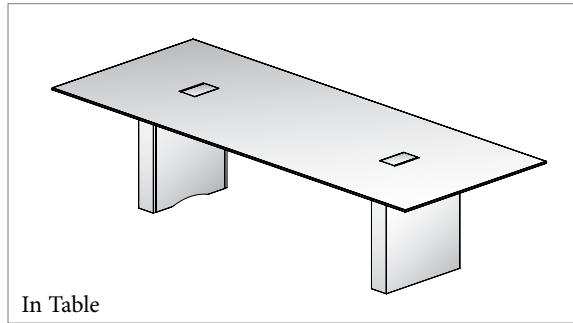
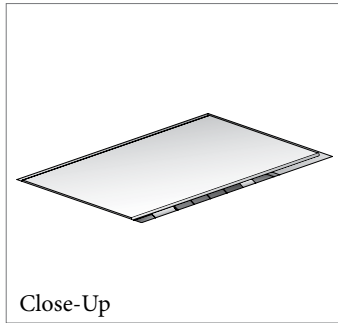

Large

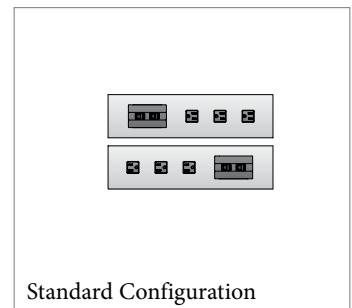
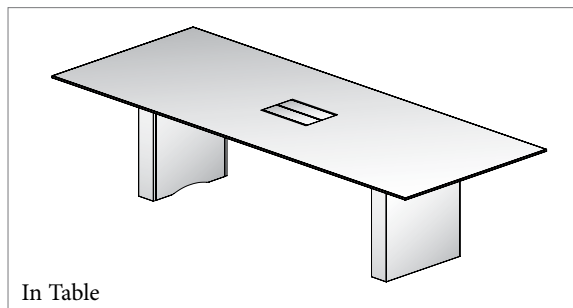
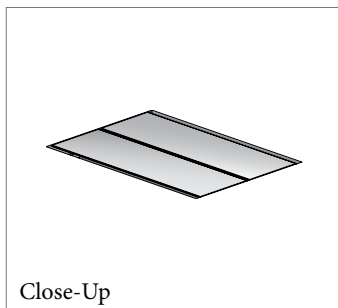

Extra Large

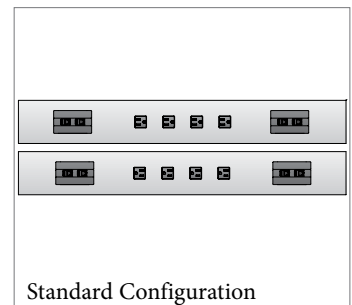
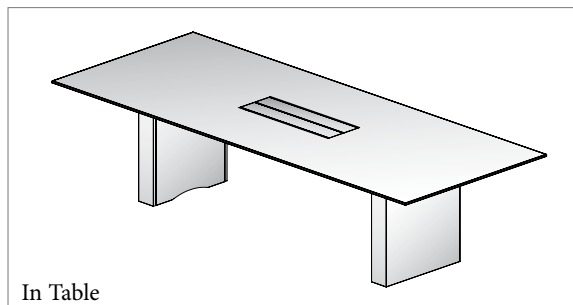
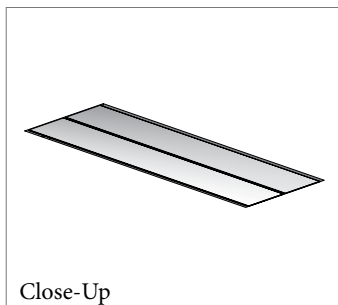

TABLE TOP POWER OPTION: POWER MATRIX

Power Matrix is filled with a broad array of high performance features and refined aesthetic elements.

POWER

Power Matrix features simplex receptacles for power connectivity, the quantity of which is pre-determined based on the size of the unit. An optional USB-A+C charger can also be specified in place of one of the simplex receptacles when desired. Corded or hardwired in-feed options add flexibility.

DATA/AV FACEPLATES

Power Matrix accommodates Modular AV Inserts/Plates for unparalleled flexibility in data and AV connectivity.

DESIGN

Power Matrix units feature a clear anodized aluminum body and a bezel-free flush mount design on wood tables for an elegant appearance. Laminate table tops include a bezel, available in powder coat, polished chrome or clear anodized finish options.

PERFORMANCE

Friction hinges ensure smooth travel through the door's range of motion and can hold the door in any position. Hidden door stops maintain the minimalist aesthetic. Cable storage is both concealed and ample.

DOORS

Power Matrix is offered in multiple door material options, including metal, glass and grain-matched wood cut from the same table top.

(Medium size shown)

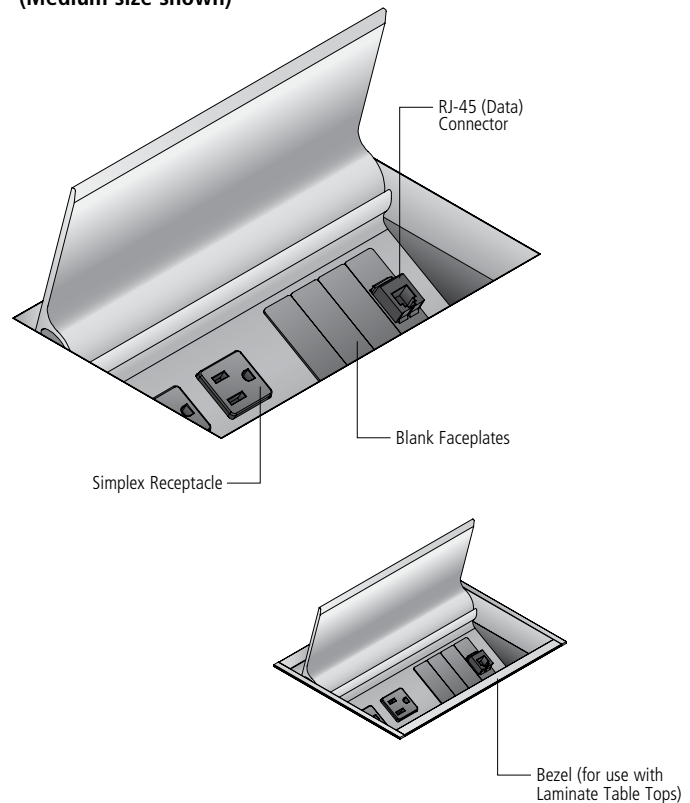

TABLE TOP POWER OPTION: POWER MATRIX

STANDARD CONFIGURATIONS

Power Matrix is offered in four standard sizes, each with a pre-determined quantity of simplex outlets and AV faceplates. With each size, an optional 2 amp USB-A+C charger (1 amp per port) replaces one of the simplex outlets.

Small and Compact

- Single door design
- 5.375" x 6" cutout
- Two simplex outlets
- Three AV faceplates. Standard configuration includes two blank faceplates and one faceplate with two RJ-45 (data) connectors.
- (1) 12' plug-in infeed cord

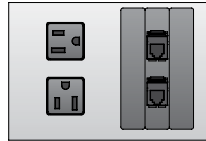

Medium

- Single door design
- 5.375" x 8.25" cutout
- Four simplex outlets
- Four AV faceplates. Standard configuration includes three blank faceplates and one faceplate with two RJ-45 (data) connectors.
- (1) 12' plug-in infeed cord

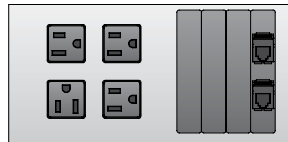

Large

- Double door design
- 10.75" x 15.25" cutout
- Six simplex outlets (three per side)
- Six AV faceplates (three per side). Standard configuration includes two blank faceplates and one faceplate with two RJ-45 (data) connectors per side.
- (2) 12' plug-in infeed cords

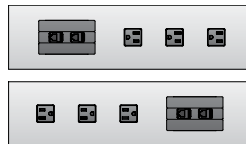

Extra Large

- Double door design
- 10.75" x 30.25" cutout
- Eight simplex outlets (four per side)
- Twelve AV faceplates (six per side). Standard configuration includes four blank faceplates and two faceplates with two RJ-45 (data) connectors per side.
- (2) 12' plug-in infeed cords



Field-Wired

Some local electrical codes may require field-wiring during installation. In such instances, a Field-Wired option may be specified. In this configuration, each Power Matrix unit will be supplied with a 6' flexible metal conduit with hot, ground and neutral wires.

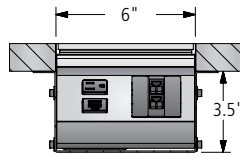
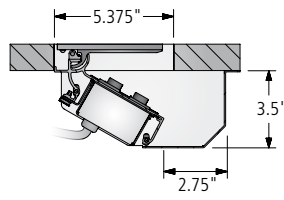

TABLE TOP POWER OPTION: POWER MATRIX

DIMENSIONS

Each Power Matrix unit includes a low-profile pan beneath the work surface to conceal the unit and provide ample storage capacity for excess cables. The size of the cutout in the table top varies with each size of Power Matrix unit.

Small



Compact

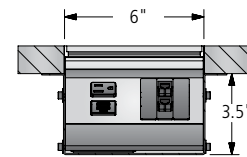
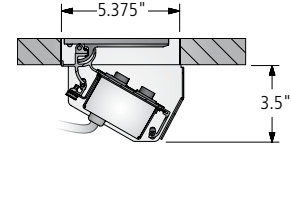

Medium

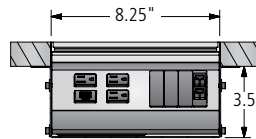
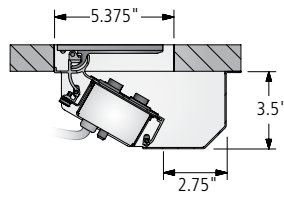

Large

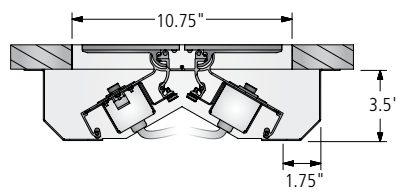

Extra Large

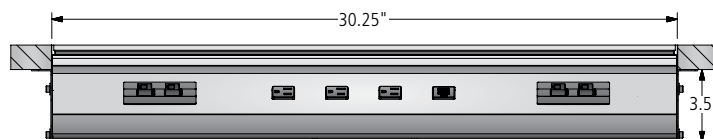
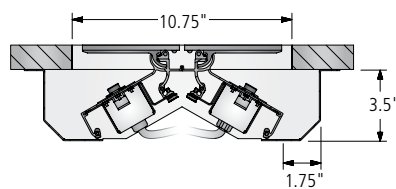

TABLE TOP POWER OPTION: POWER MATRIX

POWER PLANNING

Power Matrix is available with two options for connection with building power:

DIRECT PLUG-IN

The 15-amp power cord from each Power Matrix unit is plugged into a floor monument. The floor monument must have at least one power outlet per small or medium Power Matrix unit in the table and two power outlets per large or extra large Power Matrix (e.g., a table with four small or medium Power Matrix units would need four power outlets in the floor monument).

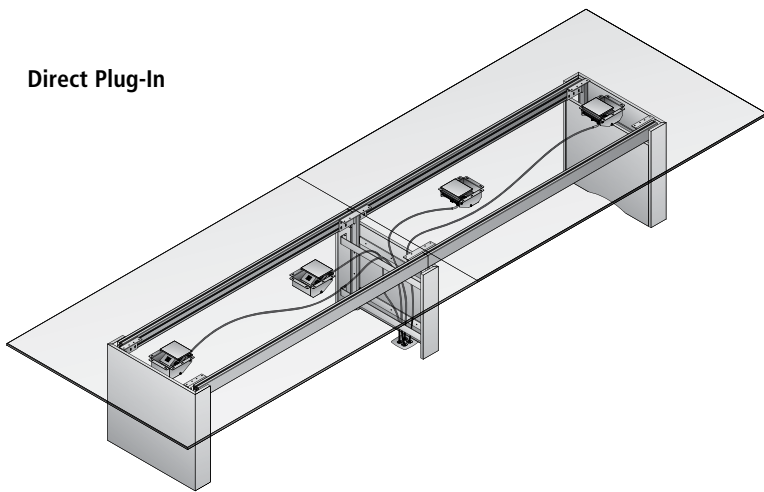

Single In-Feed

SINGLE INFEEED

Each Power Matrix unit is plugged into a two-circuit modular electrical system in the table from which a single connection is made to a floor monument. This connection can be either hardwired (to utilize both of the circuits in the modular electrical system) or corded (which requires a 20-amp power outlet in the floor monument and reduces the modular electrical system in the table to a single circuit).

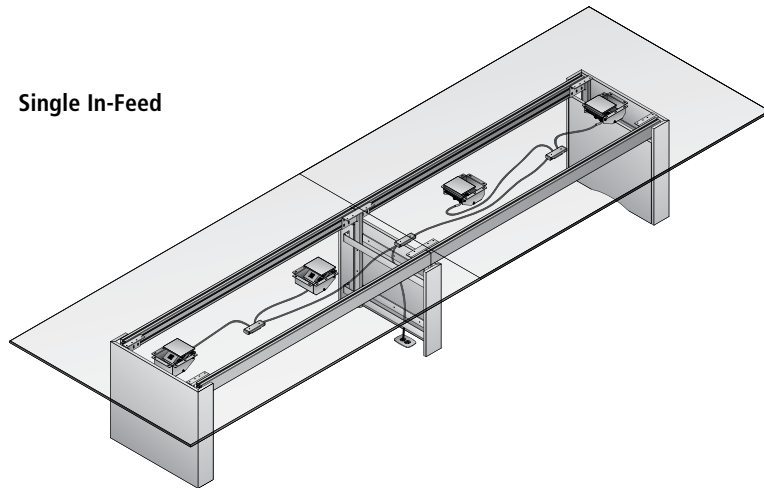

Two-Circuit Modular Electrical System

- 4-wire, 20-amp, 2-circuit modular electrical system
- Only present on tables specified with the Single In-Feed option
- Hardwire or corded (20-amp) in-feed options. A licensed electrician is required to complete hardwire connections to building's power source.
- Neutral (white) wires are 10 gauge, hot and ground wires are 12 gauge
- All electrical components satisfy National Electrical Code (NEC) requirements and are UL listed

Electrical Diagram — Hardwire Power Infeed Only

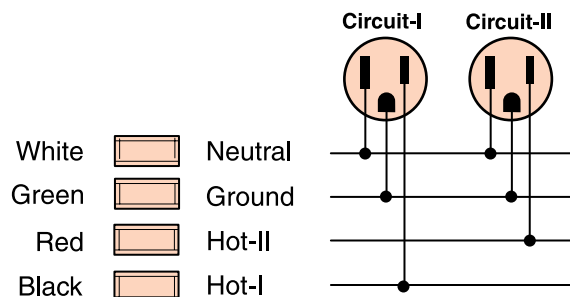



TABLE TOP POWER OPTION: POWER MATRIX

LOCATION CODES

Power Matrix is offered in a variety of locations and quantities per table size, offering a broad range of performance and pricing options.

POWER MATRIX SMALL	POWER MATRIX MEDIUM	POWER MATRIX LARGE	POWER MATRIX EXTRA LARGE	LOCATION	QUANTITY OF UNITS TO ORDER
PS-1	PM-1	PL-1	PX-1	One at center	1
PS-2	PM-2	PL-2	PX-2	One at each end	2
PS-3	PM-3	PL-3	PX-3	One at center and one at each end	3
PS-4	PM-4			Four equally spaced	4

DOOR MATERIAL AND LOCATION AVAILABILITY BY TABLE SIZE

W = Wood Door G = Glass Door M = Metal Door

Length	Top Sections	Power Matrix Small or Compact*				Power Matrix Medium				Power Matrix Large			Power Matrix Extra Large		
		PS-1	PS-2	PS-3	PS-4	PM-1	PM-2	PM-3	PM-4	PL-1	PL-2	PL-3	PX-1	PX-2	PX-3
42	1	W/G/M	-	-	-	-	-	-	-	-	-	-	-	-	-
48	1	W/G/M	-	-	-	-	-	-	-	-	-	-	-	-	-
54	1	W/G/M	-	-	-	-	-	-	-	-	-	-	-	-	-
60	1	W/G/M	-	-	-	-	-	-	-	-	-	-	-	-	-
72*	1	W/G/M	W/G/M	-	-	W/G/M	W/G/M	-	-	-	-	-	-	-	-
84	1	W/G/M	W/G/M	-	-	W/G/M	W/G/M	-	-	-	-	-	-	-	-
96	1	W/G/M	W/G/M	W/G/M	-	W/G/M	W/G/M	W/G/M	-	W/G/M	-	-	W/G/M	-	-
120	1	W/G/M	W/G/M	W/G/M	-	W/G/M	W/G/M	W/G/M	-	W/G/M	-	-	W/G/M	-	-
120	2	-	W/G/M	-	-	-	W/G/M	-	-	G/M	-	-	G/M	-	-
144	2	-	W/G/M	-	W/G/M	-	W/G/M	-	W/G/M	G/M	W/G/M	-	G/M	W/G/M	-
168	2	-	W/G/M	-	W/G/M	-	W/G/M	-	W/G/M	G/M	W/G/M	-	G/M	W/G/M	-
192	2	-	W/G/M	-	W/G/M	-	W/G/M	-	W/G/M	G/M	W/G/M	-	G/M	W/G/M	-
192	4	-	W/G/M	-	W/G/M	-	W/G/M	-	W/G/M	G/M	G/M	-	G/M	G/M	-
216	2	-	W/G/M	-	W/G/M	-	W/G/M	-	W/G/M	G/M	W/G/M	G/M	G/M	W/G/M	G/M
216	4	-	W/G/M	-	W/G/M	-	W/G/M	-	W/G/M	G/M	G/M	G/M	G/M	G/M	G/M
240	2	-	W/G/M	-	W/G/M	-	W/G/M	-	W/G/M	G/M	W/G/M	G/M	G/M	W/G/M	G/M
240	4	-	W/G/M	-	W/G/M	-	W/G/M	-	W/G/M	G/M	G/M	G/M	G/M	G/M	G/M

*72" Round tables are only available with PS-2 Compact option



TABLE TOP POWER OPTION: POWER MATRIX

POWER MATRIX SMALL OR MEDIUM LOCATION OPTIONS

Please Note: For floor core placement, please reference floor monument location information on page 20.

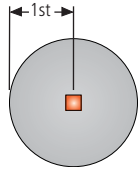

PS-1 or PM-1

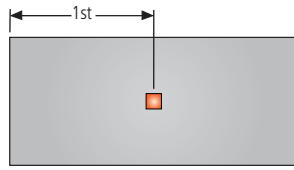

PS-1 or PM-1

Center of Power Matrix		
Length	PS-1	PM-1
42	21	21
48	24	24
54	27	27
60	30	30
72	36	36
84	42	42
96	48	48
120	60	60

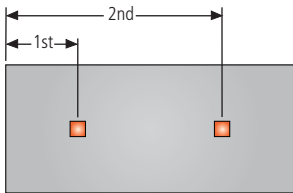

PS-2 or PM-2

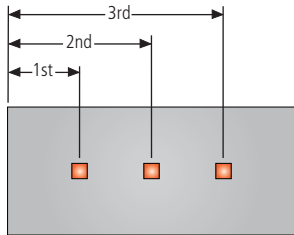

PS-3 or PM-3

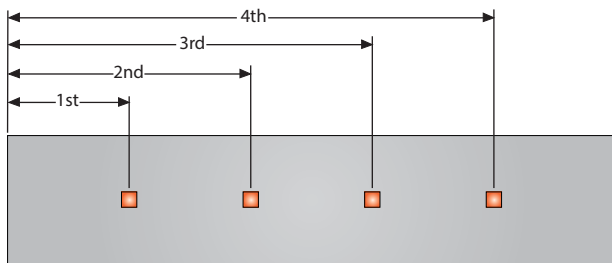

PS-4 or PM-4

Center of 2nd, 3rd or 4th Power Matrix						
Length	PS-2	PS-3	PS-4	PM-2	PM-3	PM-4
72-240	Contact Nucraft Customer Service for detailed dimension information.					



TABLE TOP POWER OPTION: POWER MATRIX

POWER MATRIX LARGE OR EXTRA LARGE LOCATION OPTIONS

Please Note: For floor core placement, please reference floor monument location information on page 20.

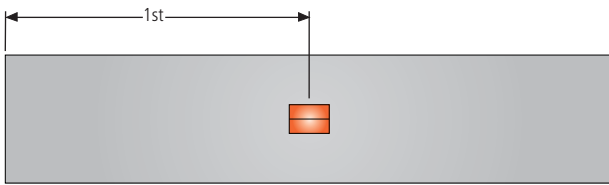

PL-1 or PX-1

Center of Power Matrix		
Length	PL-1	PX-1
96	48	48
120	60	60
144	72	72
168	84	84
192	96	96
216	108	108
240	120	120

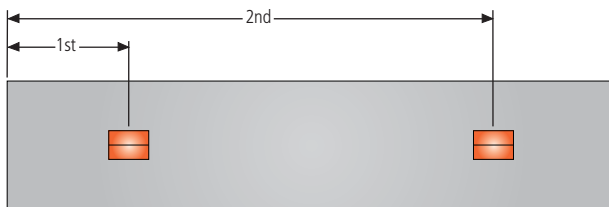

PL-2 or PX-2

Center of 2nd or 3rd Power Matrix				
Length	PL-2	PL-3	PX-2	PX-3
144-240	Contact Nucraft Customer Service for detailed dimension information.			

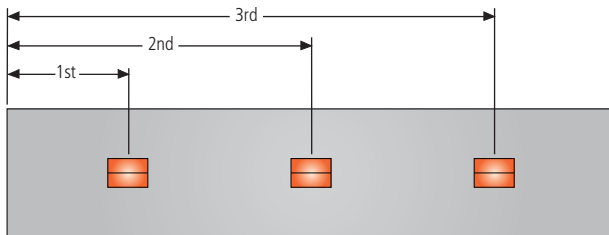

PL-3 or PX-3

TABLE TOP POWER OPTION: TECH NODE

Tech Node offers convenient access to power and voice/data connections. Tech Node features include a push/push open design that conceals internal components.

Tech Node components:

- Clear or Black Anodized Aluminum
- Fluid one touch accessibility
- Two (2) Simplexes
- Up to two voice/data ports
- 12' 15-Amp cord
- Voice/Data Adapter Kit p/n BE01421 to accept couplers & jacks
- UL Listed
- Overall dimensions - 4-7/16" x 8-5/16"
- Optional powered USB-A+C

All electrical components are UL listed.

Tech Node - Cover Open

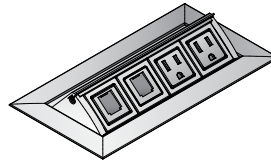

Tech Node - Cover Open with Optional USB-A+C

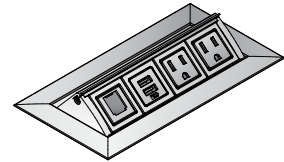

Tech Node - Cover Closed

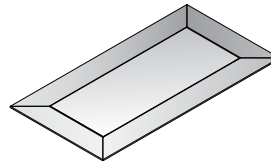

Tech Node - Open Front View

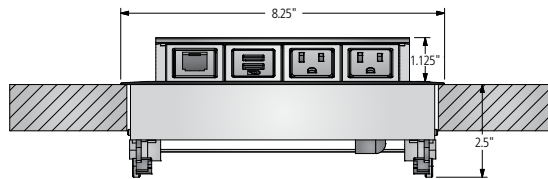

Tech Node - Open Side View

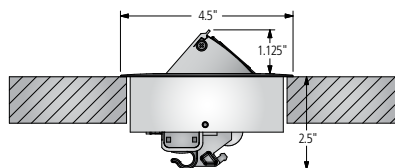

Voice/Data Planning

Two (2) simplex voice/data cutouts accept customer supplied, field-installed snap-in connectors.

Nucraft recommends consulting an audio/visual (AV) integrator for assistance with voice/data planning.

Voice/Data Product Manufacturers

Manufacturer	Phone Number	Web Site
AMP	1-800-522-6752	www.tycoelectronics.com
Avaya	1-866-462-8292	www.avaya.com
Leviton	1-800-722-2082	www.leviton.com
Panduit	1-800-777-3300	www.panduit.com
Siemon	1-860-945-4200	www.siemon.com

TABLE TOP POWER OPTION: TECH NODE

TECH NODE LOCATION OPTIONS

Please Note: For floor core placement, please reference floor monument location information on page 20.

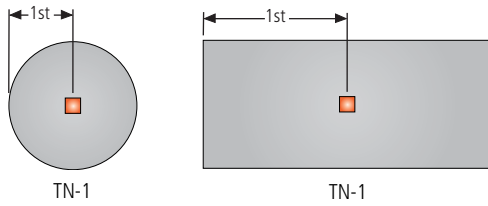

Center of Tech Node	
Length	TN-1
42	21
48	24
54	27
60	30
72	36
84	42
96	48
120	60

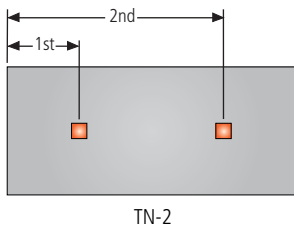

Center of 2nd, 3rd or 4th Tech Node			
Length	TN-2	TN-3	TN-4
72-240	Contact Nucraft Customer Service for detailed dimension information.		

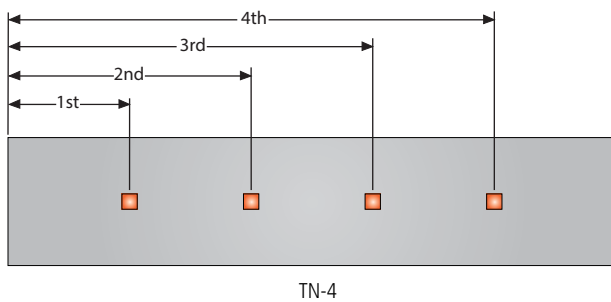
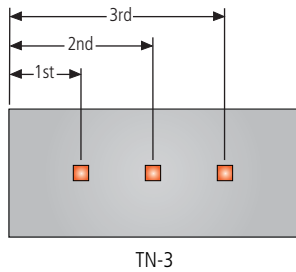



UNDER SURFACE POWER OPTION: PERIMETER POWER

Perimeter Power provides enhanced power and communication connectivity for each individual seated at a conference table. Attached to the table's apron, Perimeter Power maintains a clean aesthetic on the table top.

Perimeter Power components:

- Hardwire power in-feed (6')
- Duplex receptacles
- NEMA size single-gang cutouts (voice/data)
- Single-gang wallplate cover (blank)
- 20 AMP system

The hardwire power in-feed has a modular connector on one end; the connector attaches to the back side of any power block mounted on the table's apron. This feature allows total flexibility in determining floor monument location under any table base. All tables ship pre-wired.

Note: Clearance from the floor to the bottom of the apron is 24-3/4". Apron is recessed 2-1/8" under the table.

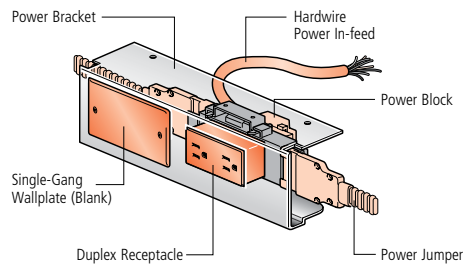
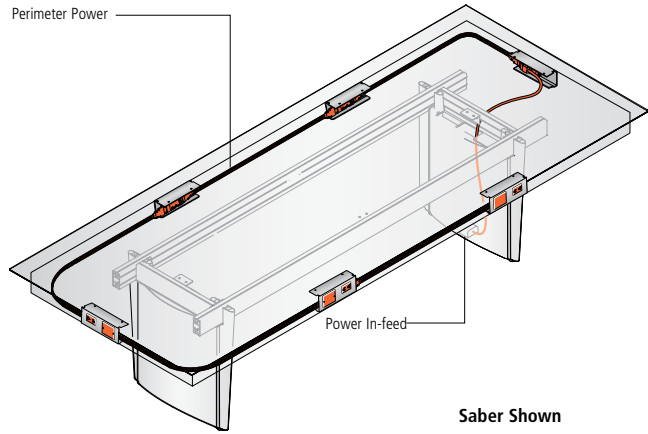

POWER AND VOICE/DATA CAPABILITIES

Refer to the individual product sections for specific Perimeter Power application guidelines.

Not available with round tops.

Table Length	Total Power Brackets	Brackets Per Side	Brackets Per End	Simplex Receptacles	Circuits	Single-Gang Cutouts
96"	6	2	1	12	1	6
120"	6	2	1	12	1	6
144"	8	3	1	16	2	8
168"	8	3	1	16	2	8
192"	8	3	1	16	2	8
216"	10	4	1	20	2	10
240"	10	4	1	20	2	10

Note: Voice/Data Jacks are customer supplied

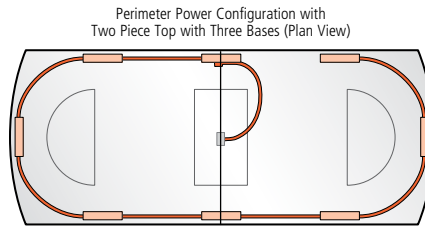

Fortè® Shown

PERIMETER POWER BRACKET DIMENSIONS

Front Elevation View

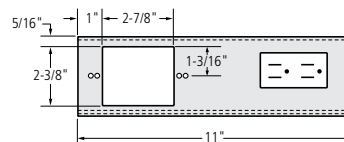

End Elevation View

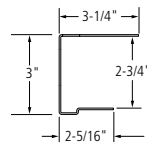

UNDER SURFACE POWER OPTION: PERIMETER POWER

POWER PLANNING

Perimeter Power Electrical System

- 8-wire, 4-circuit modular electrical system
- All tables are pre-wired
- Hardwire power in-feed only. A licensed electrician is required to complete hardwire connections to building's power source.
- Neutral (white) wires are 10 gauge, hot and ground wires are 12 gauge.
- All electrical components satisfy National Electrical Code (NEC) requirements and are UL listed

Electrical Diagram — Hardwire Power Infeed Only

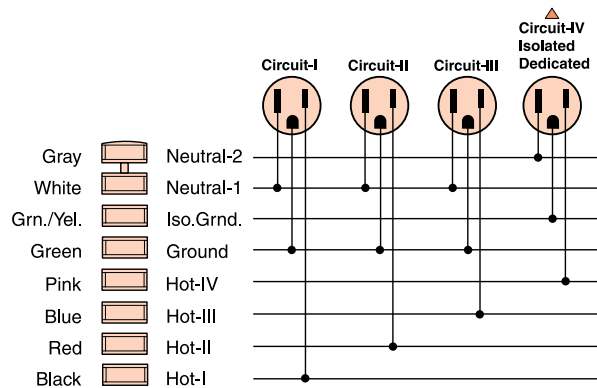

Four circuits, one isolated. This electrical schematic can be used with three-phase or single-phase power.

Field-Wired Electrical Requirements

Some local electrical codes may require field-wiring during installation. In such instances, a Field-Wired option may be specified. In this configuration, Perimeter Power includes power junction boxes instead of the standard modular electrical system. Specific electrical components such as receptacles must be furnished separately.

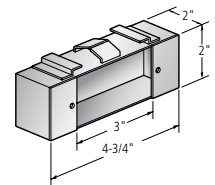

VOICE/DATA PLANNING

The Perimeter Power assembly does not include any factory-installed voice/data components. It does include one (1) NEMA size cutout per bracket with a blank wall-plate cover.

Faceplates and data connectors must be purchased and installed in the field.

Cutout Opening Dimensions

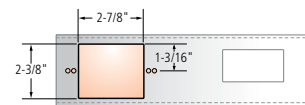

Voice/Data Product Manufacturers

Nucraft recommends consulting an audio/visual (AV) integrator for assistance with voice/data planning.

Manufacturer	Phone Number	Web Site
AMP	1-800-522-6752	www.tycoelectronics.com
Avaya	1-866-462-8292	www.avaya.com
Leviton	1-800-722-2082	www.leviton.com
Panduit	1-800-777-3300	www.panduit.com
Siemon	1-860-945-4200	www.siemon.com



FREESTANDING POWER OPTION: TECH ZONE

TECH ZONE

Simple, easy to use and portable, this freestanding table top power option allows you to easily charge all of your devices.

Available in two configurations with a variety of power and data connectivity options. Includes a 72"-long plug-in infeed cord.

ZONE-USB-C

Includes two simplex receptacles, one data port and one charging USB-A+C charging port

ZONE-DATA

Includes two simplex receptacles and two open data ports

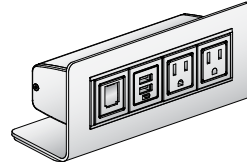

Tech Zone - Side View

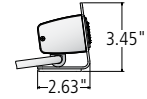

ZONE-USB-C



ZONE-DATA





WIRE MANAGEMENT OPENINGS

Panel Base

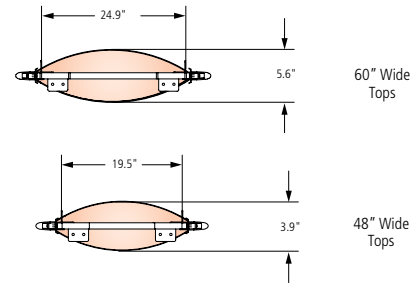
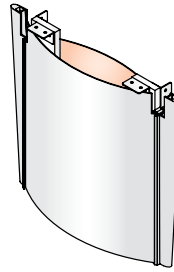

Concave Column Base

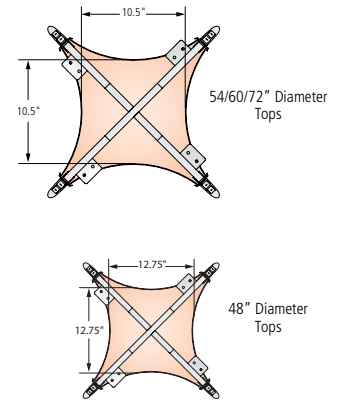
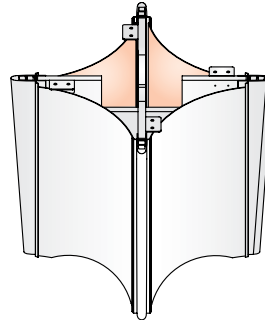



BASE DIMENSIONS

Panel Base

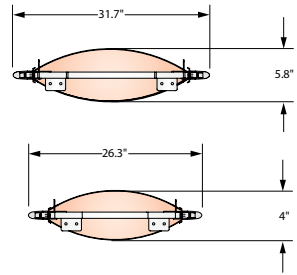
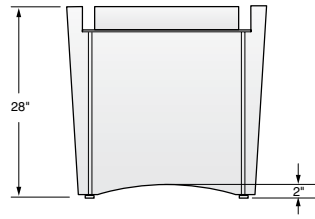

60" Wide
Tops

48" Wide
Tops

Concave Column Base

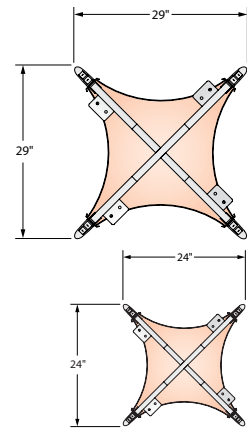
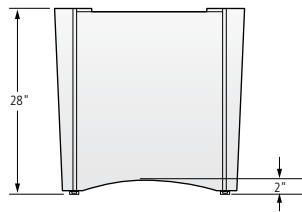

54/60/72" Diameter
Tops

48" Diameter
Tops

BASE DIMENSIONS

Metal X-Base

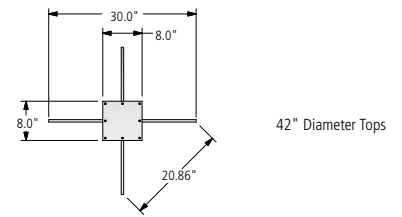
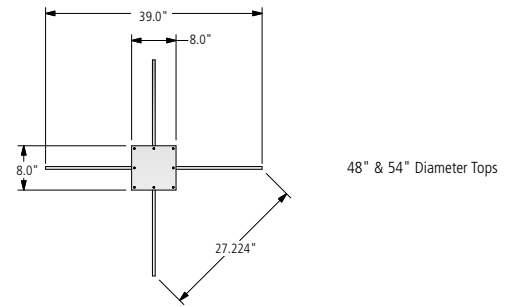
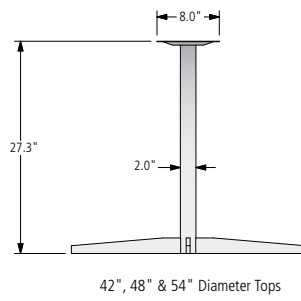
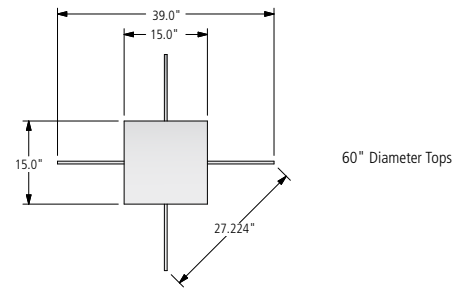
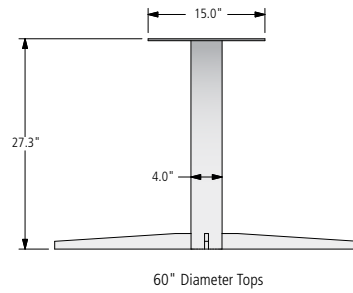

FLOOR MONUMENT LOCATIONS

Rectangle

(Panel Bases)

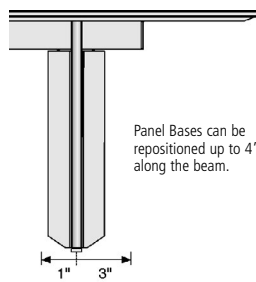
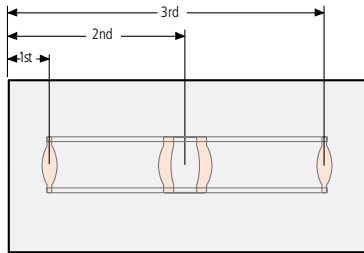

Table Size (inches)	Center of 1st Base	Center of 2nd Base	Center of 3rd Base
72 x 36	18	54	
84 x 42	21	63	
96 x 48	24	72	
120 x 48	24	96	
144 x 48	24	120	
144 x 60	30	114	
168 x 48	24	84	144
168 x 60	30	84	138
192 x 48	24	96	168
192 x 60	30	96	162
216 x 48	24	108	192
216 x 60	30	108	186
240 x 48	24	120	216
240 x 60	30	120	210

Boat

(Panel Bases)

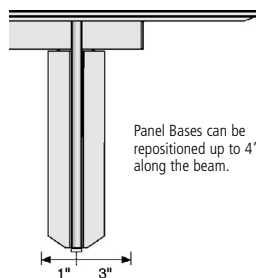
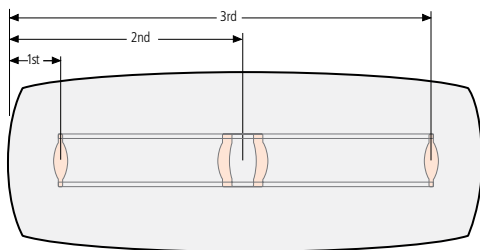

Table Size (inches)	Center of 1st Base	Center of 2nd Base	Center of 3rd Base
72 x 30/36	19	53	
84 x 43/48	24	60	
96 x 43/48	24	72	
120 x 43/48	24	96	
144 x 48/54	27	117	
168 x 48/54	27	84	141
192 x 54/60	30	96	162
216 x 54/60	30	108	186
240 x 54/60	30	120	210



VENEER TOP WITH HARDWOOD EDGE



ROUND TOP

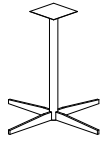

METAL X-BASE
-XB

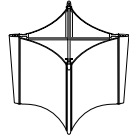

CONCAVE COLUMN BASE
-SB

BASE KEY

- XB Metal X-Base
- SB Concave Column Base

ROUND TABLES

MODEL #	DIAMETER	BASE QTY	TOP SECTIONS	SEATING CAPACITY	-XB	-SB
SR-42	42	1	1	4	3,873	-
SR-48	48	1	1	4	4,802	6,713
SR-54	54	1	1	6	5,936	8,049
SR-60	60	1	1	6	7,050	9,292
SR-72	72	1	2	8	-	12,690

OPTIONS

OPTIONS	CODE	PRICE	NOTES
Power & Data Options			See pages 25-32 (only available on Concave Column Base)
Polished Chrome Base Finish	Add -PCCH	\$593	Available on Metal X-Base only

EDGE PROFILE

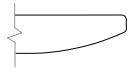

Reverse Flow Edge

GENERAL INFORMATION

- Tops are 1-1/4" thick with 3/8" deep wood edge band
- Concave Column base is standard with removable panels for wire access
- Seating capacity based on 27" per person
- Overall table height 29.5"
- No power options are available on the Metal X-Base
- Metal X-Bases are for round tops only
- Metal X-Bases are not wire management capable

REQUIRED INFORMATION (ORDER CANNOT BE ENTERED WITHOUT THIS INFORMATION)

See appendix pages vi-vii for surface material options.

- Choose Metal Finish
- Choose Veneer Finish



INSET LAMINATE TOP WITH HARDWOOD EDGE



ROUND TOP

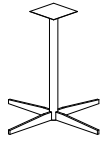

METAL X-BASE
-XB

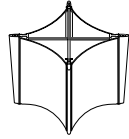

CONCAVE COLUMN BASE
-SB

BASE KEY

- XB Metal X-Base
- SB Concave Column Base

ROUND TABLES

MODEL #	DIAMETER	BASE QTY	TOP SECTIONS	SEATING CAPACITY	-XB	-SB
SR-42-P	42	1	1	4	3,660	-
SR-48-P	48	1	1	4	4,538	6,344
SR-54-P	54	1	1	6	5,610	7,607
SR-60-P	60	1	1	6	6,663	8,781
SR-72-P	72	1	2	8	-	11,993

OPTIONS

OPTIONS	CODE	PRICE	NOTES
Power & Data Options			See pages 25-32 (only available on Concave Column Base)
Polished Chrome Base Finish	Add -PCCH	\$593	Available on Metal X-Base only

EDGE PROFILE



Reverse Flow Edge

GENERAL INFORMATION

- Tops are 1-1/4" thick with 3/8" deep wood edge band
- Concave Column base is standard with removable panels for wire access
- Seating capacity based on 27" per person
- Overall table height 29.5"
- No power options are available on the Metal X-Base
- Metal X-Bases are for round tops only
- Metal X-Bases are not wire management capable

REQUIRED INFORMATION (ORDER CANNOT BE ENTERED WITHOUT THIS INFORMATION)

See appendix pages vi-vii for surface material options.

- Choose Metal Finish
- Choose Veneer Finish
- Choose Laminate



VENEER TOP WITH HARDWOOD EDGE



RECTANGLE TOP

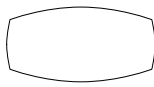

BOAT TOP

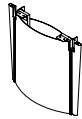

PANEL BASE
-PB

BASE KEY

PB Panel Base

RECTANGLE TABLES

MODEL #	L x W	BASE QTY	TOP SECTIONS	SEATING CAPACITY	-PB
ST-7236	72 x 36	2	1	6	6,939
ST-8442	84 x 42	2	1	8	8,864
ST-9648	96 x 48	2	1	8	10,629
ST-12048	120 x 48	2	1	10	13,056
ST-14448	144 x 48	2	2	12	15,493
ST-14460	144 x 60	2	2	14	18,965
ST-16848	168 x 48	3	2	14	20,976
ST-16860	168 x 60	3	2	16	25,339
ST-19248	192 x 48	3	2	16	22,525
ST-19260	192 x 60	3	2	18	27,367
ST-21648	216 x 48	3	2	18	25,663
ST-21660	216 x 60	3	2	20	31,335
ST-24048	240 x 48	3	2	18	27,886
ST-24060	240 x 60	3	2	20	34,198

BOAT TABLES

MODEL #	L x W	BASE QTY	TOP SECTIONS	SEATING CAPACITY	-PB
SB-7236	72 x 30/36	2	1	6	6,939
SB-8448	84 x 43/48	2	1	8	9,572
SB-9648	96 x 43/48	2	1	8	10,629
SB-12048	120 x 43/48	2	1	10	13,056
SB-14454	144 x 48/54	2	2	12	17,094
SB-16854	168 x 48/54	3	2	14	22,983
SB-19260	192 x 54/60	3	2	18	27,367
SB-21660	216 x 54/60	3	2	20	31,335
SB-24060	240 x 54/60	3	2	20	34,198

OPTIONS

CODE	PRICE	NOTES
Power & Data Options		See pages 25-32

EDGE PROFILE

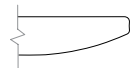

Reverse Flow Edge

GENERAL INFORMATION

- Tops are 1-1/4" thick with 3/8" deep wood edge band
- Bases can be repositioned in a range up to 4" to conceal floor monuments
- Seating capacity based on 27" per person
- Overall table height 29.5"
- Panel bases are standard with removable panels for wire access

REQUIRED INFORMATION (ORDER CANNOT BE ENTERED WITHOUT THIS INFORMATION)

See appendix pages vi-vii for surface material options.

- Choose Metal Finish
- Choose Veneer Finish



INSET LAMINATE TOP WITH HARDWOOD EDGE



RECTANGLE TOP

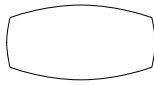

BOAT TOP



PANEL BASE
-PB

BASE KEY

PB Panel Base

RECTANGLE TABLES

MODEL #	L x W	BASE QTY	TOP SECTIONS	SEATING CAPACITY	-PB
ST-7236-P	72 x 36	2	1	6	6,558
ST-8442-P	84 x 42	2	1	8	8,377
ST-9648-P	96 x 48	2	1	8	10,045
ST-12048-P	120 x 48	2	1	10	12,338
ST-14448-P	144 x 48	2	2	12	14,641
ST-14460-P	144 x 60	2	2	14	17,922
ST-16848-P	168 x 48	3	2	14	19,823
ST-16860-P	168 x 60	3	2	16	23,946
ST-19248-P	192 x 48	3	2	16	21,287
ST-19260-P	192 x 60	3	2	18	25,862
ST-21648-P	216 x 48	3	2	18	24,252
ST-21660-P	216 x 60	3	2	20	29,612
ST-24048-P	240 x 48	3	2	18	26,353
ST-24060-P	240 x 60	3	2	20	32,318

BOAT TABLES

MODEL #	L x W	BASE QTY	TOP SECTIONS	SEATING CAPACITY	-PB
SB-7236-P	72 x 30/36	2	1	6	6,558
SB-8448-P	84 x 43/48	2	1	8	9,046
SB-9648-P	96 x 43/48	2	1	8	10,045
SB-12048-P	120 x 43/48	2	1	10	12,338
SB-14454-P	144 x 48/54	2	2	12	16,154
SB-16854-P	168 x 48/54	3	2	14	21,719
SB-19260-P	192 x 54/60	3	2	18	25,862
SB-21660-P	216 x 54/60	3	2	20	29,612
SB-24060-P	240 x 54/60	3	2	20	32,318

OPTIONS

CODE	PRICE	NOTES
Power & Data Options		See pages 25-32

EDGE PROFILE



Reverse Flow Edge

GENERAL INFORMATION

- Tops are 1-1/4" thick with 3/8" deep wood edge band
- Bases can be repositioned in a range up to 4" to conceal floor monuments
- Seating capacity based on 27" per person
- Overall table height 29.5"
- Panel bases are standard with removable panels for wire access

REQUIRED INFORMATION (ORDER CANNOT BE ENTERED WITHOUT THIS INFORMATION)

See appendix pages vi-vii for surface material options.

- Choose Metal Finish
- Choose Veneer Finish
- Choose Laminate



POWER AND DATA OPTIONS

POWER MATRIX SMALL	MODEL #	DESCRIPTION	W x D	SIMPLEX OUTLETS	BLANK	DATA*	PRICE
	PM-SM-G	Small - Glass Door	6 x 5.375	2	2	1	1,635
	PM-SM-M	Small - Metal Door	6 x 5.375	2	2	1	1,635
	PM-SM-W	Small - Wood Door	6 x 5.375	2	2	1	2,062
	PM-SM-G-C	Compact - Glass Door	6 x 5.375	2	2	1	1,635
	PM-SM-M-C	Compact - Metal Door	6 x 5.375	2	2	1	1,635
	PM-SM-W-C	Compact - Wood Door	6 x 5.375	2	2	1	2,062

*Each data faceplate includes two RJ-45 (Data) connectors

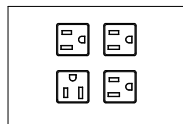

-FOUR

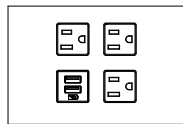

-THREE-C

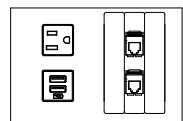

-USB-C

OPTIONS	CODE	PRICE	NOTES
4 Simplex Receptacles	Add -FOUR	No Charge	Replace Modular AV Inserts/Plates with 2 simplex receptacles
3 Simplex Receptacles/Charging USB-A+C	Add -THREE-C	No Charge	Replace Modular AV Inserts/Plates with 1 simplex receptacle and 1 charging USB-A+C
USB-A+C Charging	Add -USB-C	\$128 per unit	USB-A+C charger, replaces one of the simplex outlets
Polished Chrome Door	Add -PD	\$245 per unit	Only available with metal door option
Polished Chrome Bezel	Add -PB	\$349 per unit	Only available on glass, stone and laminate top tables
Field-Wired	Add -FW	Deduct \$48 per unit	May be required in New York City, Chicago and San Francisco. Check with an electrician for local codes and requirements.
Single Infeed Option Available	See page 30		

GENERAL INFORMATION

- Wood species and finish will default to the same as the table top if wood door version is specified
- Glass & wood doors are 1/4" -thick, metal doors are 1/8" -thick
- Glass door is back-painted low-iron glass
- Interior body is clear anodized aluminum
- Each unit includes a 15 amp, 12' power infeed (plug in only)
- If Field-Wired option is specified, each unit includes a 6' flexible metal conduit and requires a hardwire connection
- Standard configuration: Two simplex receptacles, two RJ-45 data connectors and two single blank faceplates
- When specified on tables with laminate tops, each Power Matrix unit will include a metal bezel and is limited to the glass and metal door options. (-B) will be added to the model number for the bezel.
- Additional data/AV faceplate options are on page 30

REQUIRED INFORMATION: (ORDER CANNOT BE ENTERED WITHOUT THIS INFORMATION)

See appendix pages vi-vii for surface material options.

- Choose location code & quantity from the chart on page 29
- Choose Glass Door Finish, if glass door version is specified
- Choose Metal Finish, if metal door version is specified or for the bezel finish on laminate tables



POWER AND DATA OPTIONS

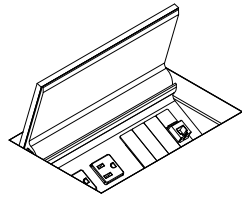

POWER MATRIX MEDIUM	MODEL #	DESCRIPTION	W x D	SIMPLEX OUTLETS	BLANK	DATA*	PRICE
	PM-MD-G	Medium - Glass Door	6 x 8.25	4	3	1	2,576
	PM-MD-M	Medium - Metal Door	6 x 8.25	4	3	1	2,576
	PM-MD-W	Medium - Wood Door	6 x 8.25	4	3	1	3,006

*Each data faceplate includes two RJ-45 (Data) connectors

OPTIONS	CODE	PRICE	NOTES
USB-A+C Charging	Add -USB-C	\$128 per unit	USB-A+C charger, replaces one of the simplex outlets
Polished Chrome Door	Add -PD	\$330 per unit	Only available with metal door option
Polished Chrome Bezel	Add -PB	\$390 per unit	Only available on glass, stone and laminate top tables
Field-Wired	Add -FW	Deduct \$48 per unit	May be required in New York City, Chicago and San Francisco. Check with an electrician for local codes and requirements.
Single Infeed Option Available	See page 30		

GENERAL INFORMATION

- Wood species and finish will default to the same as the table top if wood door version is specified
- Glass & wood doors are 1/4" -thick, metal doors are 1/8" -thick
- Glass door is back-painted low-iron glass
- Interior body is clear anodized aluminum
- Each unit includes a 15 amp, 12' power infeed (plug in only)
- If Field-Wired option is specified, each unit includes a 6' flexible metal conduit and requires a hardwire connection
- Standard configuration: Four simplex receptacles, two RJ-45 data connectors and three single blank faceplates
- When specified on tables with laminate, glass or stone/quartz tops, each Power Matrix unit will include a metal bezel and is limited to the glass and metal door options. (-B) will be added to the model number for the bezel.
- Additional data/AV faceplate options are on page 30

REQUIRED INFORMATION: (ORDER CANNOT BE ENTERED WITHOUT THIS INFORMATION)

See appendix pages vi-vii for surface material options.

- Choose location code & quantity from the chart on page 29
- Choose Glass Door Finish, if glass door version is specified
- Choose Metal Finish, if metal door version is specified or for the bezel finish on laminate and glass tables



POWER AND DATA OPTIONS

POWER MATRIX LARGE	MODEL #	DESCRIPTION	W x D	SIMPLEX OUTLETS	BLANK	DATA*	PRICE
	PM-LG-G	Large - Glass Door	15.25 x 10.75	6	4	2	4,293
	PM-LG-M	Large - Metal Door	15.25 x 10.75	6	4	2	4,293
	PM-LG-W	Large - Wood Door	15.25 x 10.75	6	4	2	4,977

*Each data faceplate includes two RJ-45 (Data) connectors

OPTIONS	CODE	PRICE	NOTES
USB-A+C Charging	Add -USB-C	\$249 per unit	USB-A+C charger, replaces one of the simplex outlets per side
Polished Chrome Door	Add -PD	\$811 per unit	Only available with metal door option
Polished Chrome Bezel	Add -PB	\$627 per unit	Only available on glass, stone and laminate top tables
Field-Wired	Add -FW	Deduct \$87 per unit	May be required in New York City, Chicago and San Francisco. Check with an electrician for local codes and requirements.
Single Infeed Option Available	See page 30		

GENERAL INFORMATION

- Wood species and finish will default to the same as the table top if wood door version is specified
- Glass & wood doors are 1/4"-thick, metal doors are 1/8"-thick
- Glass door is back-painted low-iron glass
- Interior body is clear anodized aluminum
- Each unit includes (2) 15 amp, 12' power infeeds (plug in only)
- If Field-Wired option is specified, each unit includes a 6' flexible metal conduit and requires a hardwire connection
- Standard configuration: Six simplex receptacles, four RJ-45 data connectors and four single blank faceplates
- When specified on tables with laminate tops, each Power Matrix unit will include a metal bezel and is limited to the glass and metal door options. (-B) will be added to the model number for the bezel.
- Additional data/AV faceplate options are on page 30

REQUIRED INFORMATION: (ORDER CANNOT BE ENTERED WITHOUT THIS INFORMATION)

See appendix pages vi-vii for surface material options.

- Choose location code & quantity from the chart on page 29
- Choose Glass Door Finish, if glass door version is specified
- Choose Metal Finish, if metal door version is specified or for the bezel finish on laminate tables

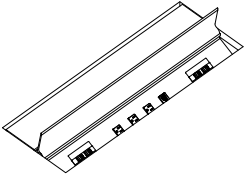

POWER AND DATA OPTIONS

POWER MATRIX EXTRA LARGE	MODEL #	DESCRIPTION	W x D	SIMPLEX OUTLETS	BLANK	DATA*	PRICE
	PM-XL-G	Extra Large - Glass Door	30.25 x 10.75	8	8	4	6,005
	PM-XL-M	Extra Large - Metal Door	30.25 x 10.75	8	8	4	6,005
	PM-XL-W	Extra Large - Wood Door	30.25 x 10.75	8	8	4	6,692

*Each data faceplate includes two RJ-45 (Data) connectors

OPTIONS	CODE	PRICE	NOTES
USB-A+C Charging	Add -USB-C	\$249 per unit	USB-A+C charger, replaces one of the simplex outlets per side
Polished Chrome Door	Add -PD	\$1,137 per unit	Only available with metal door option
Polished Chrome Bezel	Add -PB	\$817 per unit	Only available on glass, stone and laminate top tables
Field-Wired	Add -FW	Deduct \$87 per unit	May be required in New York City, Chicago and San Francisco. Check with an electrician for local codes and requirements.
Single Infeed Option Available	See page 30		

GENERAL INFORMATION

- Wood species and finish will default to the same as the table top if wood door version is specified
- Glass & wood doors are 1/4"-thick, metal doors are 1/8"-thick
- Glass door is back-painted low-iron glass
- Interior body is clear anodized aluminum
- Each unit includes (2) 15 amp, 12' power infeeds (plug in only)
- If Field-Wired option is specified, each unit includes a 6' flexible metal conduit and requires a hardwire connection
- Standard configuration: Eight simplex receptacles, eight RJ-45 data connectors and eight single blank faceplates
- When specified on tables with laminate tops, each Power Matrix unit will include a metal bezel and is limited to the glass and metal door options. (-B) will be added to the model number for the bezel.
- Additional data/AV faceplate options are on page 30

REQUIRED INFORMATION: (ORDER CANNOT BE ENTERED WITHOUT THIS INFORMATION)

See appendix pages vi-vii for surface material options.

- Choose location code & quantity from the chart on page 29
- Choose Glass Door Finish, if glass door version is specified
- Choose Metal Finish, if metal door version is specified or for the bezel finish on laminate tables



POWER AND DATA OPTIONS

LOCATION CODES	POWER MATRIX SMALL/COMPACT	POWER MATRIX MEDIUM	POWER MATRIX LARGE	POWER MATRIX EXTRA LARGE	LOCATION	QUANTITY OF UNITS TO ORDER
	PS-1	PM-1	PL-1	PX-1	One at center	1
	PS-2	PM-2	PL-2	PX-2	One at each end	2
	PS-3	PM-3	PL-3	PX-3	One at center and one at each end	3
	PS-4	PM-4			Four equally spaced (tables 132" and longer)	4

DOOR MATERIAL AND LOCATION AVAILABILITY BY TABLE SIZE

W = Wood Door G = Glass Door M = Metal Door

Length	Top Sections	Power Matrix Small or Compact				Power Matrix Medium				Power Matrix Large			Power Matrix Extra Large		
		PS-1	PS-2	PS-3	PS-4	PM-1	PM-2	PM-3	PM-4	PL-1	PL-2	PL-3	PX-1	PX-2	PX-3
42	1	W/G/M	-	-	-	-	-	-	-	-	-	-	-	-	-
48	1	W/G/M	-	-	-	-	-	-	-	-	-	-	-	-	-
54	1	W/G/M	-	-	-	-	-	-	-	-	-	-	-	-	-
60	1	W/G/M	-	-	-	-	-	-	-	-	-	-	-	-	-
72*	1	W/G/M	W/G/M	-	-	W/G/M	W/G/M	-	-	-	-	-	-	-	-
84	1	W/G/M	W/G/M	-	-	W/G/M	W/G/M	-	-	-	-	-	-	-	-
96	1	W/G/M	W/G/M	W/G/M	-	W/G/M	W/G/M	W/G/M	-	W/G/M	-	-	W/G/M	-	-
120	1	W/G/M	W/G/M	W/G/M	-	W/G/M	W/G/M	W/G/M	-	W/G/M	-	-	W/G/M	-	-
120	2	-	W/G/M	-	-	-	W/G/M	-	-	G/M	-	-	G/M	-	-
144	2	-	W/G/M	-	W/G/M	-	W/G/M	-	W/G/M	G/M	W/G/M	-	G/M	W/G/M	-
168	2	-	W/G/M	-	W/G/M	-	W/G/M	-	W/G/M	G/M	W/G/M	-	G/M	W/G/M	-
192	2	-	W/G/M	-	W/G/M	-	W/G/M	-	W/G/M	G/M	W/G/M	-	G/M	W/G/M	-
192	4	-	W/G/M	-	W/G/M	-	W/G/M	-	W/G/M	G/M	G/M	-	G/M	G/M	-
216	2	-	W/G/M	-	W/G/M	-	W/G/M	-	W/G/M	G/M	W/G/M	G/M	G/M	W/G/M	G/M
216	4	-	W/G/M	-	W/G/M	-	W/G/M	-	W/G/M	G/M	G/M	G/M	G/M	G/M	G/M
240	2	-	W/G/M	-	W/G/M	-	W/G/M	-	W/G/M	G/M	W/G/M	G/M	G/M	W/G/M	G/M
240	4	-	W/G/M	-	W/G/M	-	W/G/M	-	W/G/M	G/M	G/M	G/M	G/M	G/M	G/M

*72" Round tables are only available with PS-2 Compact option



POWER AND DATA OPTIONS

DATA FACEPLATES	MODEL #	DESCRIPTION	STYLE	W x H	PRICE
	FLDF-1	Blank faceplate, single height	Single	3-1/2 x 5/8	81
	FLDF-2	One VGA 15-pin HD Female to Female Gender Changer, one 3.5mm Stereo Mini Jack to Solder Tabs	Single	3-1/2 x 5/8	284
	FLDF-3	One VGA 15-pin HD Female to Female Gender Changer	Single	3-1/2 x 5/8	223
	FLDF-4	One RJ-11 Female to Punch Down - Phone	Single	3-1/2 x 5/8	223
	FLDF-5	One RJ-45 Female to Female Barrel - Data	Single	3-1/2 x 5/8	182
	FLDF-6	Two RJ-45 Female to Female Barrels, single height	Single	3-1/2 x 5/8	244
	FLDF-7	Two RJ-45 Female to Punch Down for CAT 6 - AMP	Single	3-1/2 x 5/8	345
	FLDF-8	Two RJ-45 Female to Punch Down for CAT 6 - Leviton	Single	3-1/2 x 5/8	345
	FLDF-10	Two RJ-45 Female to Punch Down for CAT 6 - Panduit	Single	3-1/2 x 5/8	345
	FLDF-11	Two USB A Female to Two USB A Female on 10" Pigtails	Single	3-1/2 x 5/8	386
	FLDF-12	Blank faceplate, double height	Double	3-1/2 x 1-3/8	101
	FLDF-13	Two RJ-45 Female to Female Barrels, double height	Double	3-1/2 x 1-3/8	244
	FLDF-14	Cable Pass-Through Set - one top, one bottom	Double	3-1/2 x 1-3/8	426
	FLDF-15	One HDMI Female to Female Barrel	Single	3-1/2 x 5/8	284

GENERAL INFORMATION

- Faceplates are black

SINGLE INFEED OPTION	MODEL #	DESCRIPTION	PRICE
	SI-H	Single In-Feed Option, Hard-wired	608
	SI-C	Single In-Feed Option, Corded (Plug-in)	734

GENERAL INFORMATION

- Tables 72"-120" in length include 2 duplex receptacles with the modular power system
- Tables 132"-240" in length include 3 duplex receptacles with the modular power system
- Hardwired and Corded Single Infeed options are 7' long
- Single Infeed option cannot be specified in conjunction with the Field-Wired (-FW) option

PERIMETER POWER	MODEL #	TABLE LENGTH	SEATING CAPACITY	ELECTRICAL OUTLETS	TOTAL BRACKETS	BRACKETS PER SIDE	PRICE
	PER-96	96 x 48	12	6	2	2	6,264
	PER-120	120 x 48	12	6	2	2	6,264
	PER-144	144 x 48	16	8	3	2	8,350
	PER-144-60	144 x 60	16	8	3	2	8,350
	PER-168	168 x 48	16	8	3	2	8,350
	PER-168-60	168 x 60	16	8	3	2	8,350
	PER-192	192 x 48	16	8	3	3	8,350
	PER-192-60	192 x 60	16	8	3	3	8,350
	PER-216	216 x 48	20	10	4	3	10,431
	PER-216-60	216 x 60	20	10	4	3	10,431
	PER-240	240 x 48	20	10	4	3	11,955
	PER-240-60	240 x 60	20	10	4	3	11,955

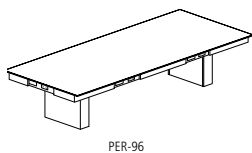

PER-96

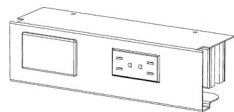

Power Bracket

OPTIONS	CODE	PRICE	NOTES
Field-Wired Options:			
96"-120" Tables	Add -FW	Deduct \$1,964	Some local electrical codes may require hardwiring of components and may not allow the use of standard modular power systems. A junction box will be provided when ordering the -FW option
132"-192" Tables	Add -FW	Deduct \$2,401	
204"-240" Tables	Add -FW	Deduct \$2,941	

GENERAL INFORMATION

- Available on Rectangle, Sight Line and Boat tops
- Wood species and finish will default to the same as the table top
- One Power Bracket per end
- All electrical components included (unless **-FW** option is chosen)
- 24-3/4" clearance from floor to underside of apron

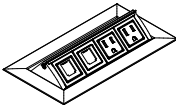

POWER AND DATA OPTIONS

TECH NODE	MODEL #	W X D	SIMPLEX RECEPTACLES	OPEN DATA PORTS	CHARGING USB-A+C	PRICE
 PUP	PUP	8 x 4	2	2	-	597
	PUP-USB-C	8 x 4	2	1	1	711

OPTIONS	CODE	PRICE	NOTES
Field-Wired	Add -FW	No Charge	May be required in New York City, Chicago and San Francisco. Check with an electrician for local codes and requirements.

GENERAL INFORMATION

- 36" cord and a 15-amp plug-in power Infeed
- Voice/data modules must be ordered separately; contact your local AV integrator
- PUP defaults to color of metal finish specified on tables (Shadow, Storm, Black, Aged Bronze, Satin Bronze and Galaxy receive Black Anodized Tech Node; Cloud, Burnished and Foil receive Clear Anodized Tech Node)
- UL Listed
- Includes a Voice/Data Adapter Kit to accept couplers and jacks when required

REQUIRED INFORMATION: (ORDER CANNOT BE ENTERED WITHOUT THIS INFORMATION)

- See appendix pages vi-vii for surface material options.
- Choose location code and quantity from chart below

GROMMET	MODEL #	DESCRIPTION	DIAMETER	PRICE
 GR	GR	Round Grommet	2" Dia	242

OPTIONS	CODE	PRICE	NOTES
Polished Chrome Grommet	Add -PCG	\$98 per unit	

GENERAL INFORMATION

- Metal finish will default to the metal chosen for the table unless otherwise specified
- Available at center location only

REQUIRED INFORMATION: (ORDER CANNOT BE ENTERED WITHOUT THIS INFORMATION)

- See appendix pages vi-vii for surface material options.
- Choose Metal Finish: Powder Coat, Clear Anodized or Polished Chrome (upcharge applies)

LOCATION CODES	TECH NODE	ROUND GROMMET	LOCATION	QUANTITY OF UNITS TO ORDER
	TN-1	G-1	One at center	1
	TN-2		One at each end	2
	TN-3		One at center and one at each end	3
	TN-4		Four equally spaced	4



FREESTANDING POWER OPTION

TECH ZONE	MODEL #	DESCRIPTION	SIMPLEX OUTLETS	OPEN DATA PORTS	CHARGING USB-A+C	PRICE
	ZONE-DATA	(2) Simplex receptacles, (2) Open data ports	2	2	-	375
	ZONE-USB-C	(2) Simplex receptacles, (1) Charging USB-A+C, (1) Open data port	2	1	1	449

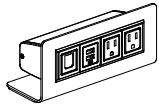

ZONE-USB-C



ZONE-DATA



ZONE-USB-C

GENERAL INFORMATION

- 72" long plug-in infeed cord
- Finish is black
- Includes a Voice/Data Adapter Kit to accept couplers and jacks when required



Appendix



This price book supercedes all previous versions.

Before placing your order, confirm you have all required information necessary. Lead times for orders begin after all required information is included and correct.

Delivery Information

We know lead times are important and sticking to them even more so. We work to maintain a 6-8 week lead time on all standard products in this book from receipt of a clean order. All orders are acknowledged with an approximate shipping date and will be invoiced with the price in effect at the date the purchase order is received. For current lead times, please review www.nucraft.com/resources/lead-times.

Shipping charges are prepaid (within the continental U.S.). Therefore, pricing is a delivered price based on normal ground transportation. If you have special instructions, need to ship by air, or are shipping to Alaska or Hawaii, contact Nucraft Customer Service. Nucraft can also help arrange to have products blanket wrapped for an additional charge. Contact the Nucraft Customer Service team or specify it on your purchase order.

Minimum Freight Charge: Any order below \$3,000 net will be assessed a \$500 net minimum freight charge (one per order).

Orders are subject to acquiring the materials required for manufacturing. Fulfillment can be affected by strikes, fires, embargoes and acts of government. These elements are beyond our control.

Nucraft offers a variety of services to accommodate a wide range of delivery requirements. Availability of these services is dependent on a number of factors and may not be offered with all shipments. Examples of delivery services that have additional fees include:

- Specific date
- Specific time of day, morning or afternoon
- Delivery to a warehouse before delivery to its final destination (unless product is picked up at the warehouse)

Contact the Nucraft Customer Service team for availability and pricing on these services.

Freight Terms

Shipping charges for Nucraft products are prepaid for standard delivery in the continental United States. Standard delivery is defined as follows: Product is delivered on a 53' trailer being pulled by a long-haul tractor (total length of 85'). Facility will receive delivery Monday through Friday between the hours of 8:00 AM and 4:00 PM. Facility has docks with levelers and a fork truck for unloading. Product will be loaded on load bars two levels high. Receiving facility is responsible to have personnel on hand to unload the truck upon arrival, drivers do not unload. Delivery sites or times that do not meet these criteria may be accommodated, but will incur a charge to cover additional shipping costs. Please **notify Nucraft a minimum of two weeks prior to shipment** to arrange special services and determine additional charges.

Storage

Nucraft has no storage facilities for finished product. If a customer cannot accept an order when it is ready for shipment, the customer must designate an alternative shipping address. If no address is provided, Nucraft may, at its discretion, transfer the product to storage. If product is transferred to an off-site storage facility, the customer may be charged for transportation to the facility and for any associated storage fees. Nucraft considers transfer of the product to a storage facility the equivalent of shipment, including invoicing and payment. Customers assume the risk of damage or loss during storage.

Transportation Times and Delays

Third party carriers that Nucraft contracts with will make reasonable efforts to accommodate requested delivery times and dates. Scheduled delivery appointments may, however, be delayed for a variety of reasons, including inclement weather, traffic, transportation equipment problems, and delays encountered at other delivery locations along the delivery route. Nucraft does not recommend scheduling activities that depend on the delivery appointment (for example, scheduling furniture installers to install furniture the day of the delivery appointment). Nucraft shall not be liable for any costs incurred as a result of a missed delivery appointment.

Shipment Damage Claims

Legal title to merchandise passes to the buyer upon acceptance by the carrier. Inspect all cartons upon delivery. Details of visible damage should be noted on the delivery receipt. Do not destroy packaging, transport to site, or install product if damage is found upon inspection. Inspection of products should be completed upon delivery to the receiver. If visible damage is apparent, a claim should be filed immediately with Nucraft Customer Service. If visible damage is not apparent, sign the delivery receipt "No visible damage." This will allow recourse for a concealed damage claim. Concealed damage claims must be filed within 15 days of receipt, **prior to transporting or installing any product.**

Do not destroy packing materials until shipment has been inspected. If damage is found, proceed to file a claim with Nucraft Customer Service.

Failure to make any claims against Nucraft within 15 days shall constitute acceptance of the merchandise and a waiver of any defects, errors or shortages discovered upon inspection.

Cancellations

Cancellations must be reviewed by our Customer Service team. Because we build your products to order, orders cannot be cancelled once processing has begun. Processing includes but is not limited to development of shop drawings and other engineering drawings. If cancellation is approved, a processing fee of 20-100% will be assessed based on the status of the order.

Change Order Policy

Nucraft will make every attempt to honor any reasonable change request to product provided that the request is received prior to start of production. Change orders will be accepted only if the request is made in writing and received in time to make the change. Nucraft reserves the right to increase our acknowledged price and ship date if necessary to make the requested changes. Please submit any change order request to our Customer Service team. Nucraft will assess charges to the customer as stipulated in the following:

- Standard Orders: Change orders received prior to production will be charged \$400 net to cover administrative costs.
- Special Orders: Change orders received prior to production will be charged \$400 net to cover administrative costs. There may be additional costs associated with engineering labor required for the change order.
- Change orders received after production must be evaluated by Nucraft. If approved, the charge will be \$400 net plus any restocking charges accumulated. There may be additional costs associated with engineering and/or manufacturing labor, as well as material costs, required for the change order.



Repair Authorization

Prior written approval is required for repairs of merchandise charged to Nucraft. Failure to do so will result in customer funded repairs.

Payment Terms

Deposits are required at the time of order due to the custom nature of our products. See information regarding Cancellations above.

Credit terms are available to qualified customers. Please contact AR@Nucraft.com to start the application process. Note that the credit application process requires a valid sales tax exemption or resale tax certificate, Form W-9, and three current trade references.

Credit Card Payments are accepted via web portal. Please contact AR@Nucraft.com for payment instructions. Note that a 2% convenience fee will be added for using this payment method and no early pay discounts are allowed on credit card payments.

Warranty

Nucraft Furniture is warranted to be free from defects in materials and workmanship for a period of ten years of single shift use. Limitations include:

- Mechanical Devices such as latches, casters, and other moving components are warranted for five years of the date of original delivery.
- Height adjustable components are warranted for two years of the date of original delivery.
- The following are warranted for one year of the date of original delivery:
 - Textiles
 - Electrical Components
 - Refrigeration Units
 - Custom Products not described in Nucraft's Catalogue

This warranty is applicable only if furniture is properly installed and maintained in an office environment. This warranty extends only to products manufactured and sold in North America and only to original purchasers acquiring new Nucraft product through authorized dealers or approved sellers.

During this warranty period, Nucraft's sole obligation is to repair or replace, at Nucraft's discretion, products which prove to be defective during the warranty period.

This warranty does not cover:

- Damage caused by a carrier.
- Damage from user modification, misuse, abuse, accident, or negligence.
- Customer's Own Material (COM) specified by the customer that is not a standard product offering.
- Color, grain, or texture of wood and other covering material.

Nucraft extends no other warranties, expressed or implied, including warranty of merchantability or fitness for a particular purpose. Nucraft shall not be liable for loss of time, inconvenience, commercial loss, incidental or consequential damages.

Environmental Statement

Nucraft is committed to supporting responsible environmental policies and practices in all that we do. We strive for sustainability, weighing our business decisions against the costs to the ecological, social and economic systems they affect.

Our products are manufactured to meet the credit requirements of the U.S. Green Building Council's LEED rating systems in one or more of the following categories:

- Recycled Content
- Certified Wood
- Low-Emitting Materials

Computer Aided Planning

Nucraft products and pricing are available via CET and 2020 Worksheet, an AutoCAD®-based space planning tool.

2020 Worksheet is an integrated software system developed specifically for interior designers and facility planners to enhance workplace performance. This modern suite of applications works together seamlessly, in concert. Navigate catalogs, select products, design in plan view and 3D, assign options, create worksheets and build a project where you want, when you want. Take your pick. It's dynamic and interactive. Design projects are a work in progress. And now you can perform any of the many discrete tasks that go into a project any time, any place.

Product symbols (Revit, 2D and 3D) are available on the Nucraft website at www.nucraft.com/resources/designer-tools/product-symbols.

iSpec®

Nucraft offers a free online product configuration and specification service that saves you time and allows you to be creative while leaving the nuts and bolts to someone else. No specific software is required, nor is there any learning curve. This service applies to all Nucraft products. For additional information, visit www.nucraft.com/resources/designer-tools/ispec.



Surface Materials Palette

We crafted our materials palette using the same demanding standards that distinguish our furniture. Thoughtful design and attention to every detail elevate your possibilities.

Anchored by Nucraft veneers, unrivaled for clarity, quality, and depth of finish, our collection of surface materials comprises a sophisticated set of balanced elements that supports your design vision.

Some elements have their roots in Nucraft's rich heritage. Others are new materials and reflect current trends and taste. Together, they ensure that you're ready for today and positioned well for the future. Beautifully.

Custom Finishes

Nucraft specializes in expert custom finish matching. For a nominal upcharge we can provide custom finishes, and we are frequently asked to match the finishes of other furniture manufacturers. For finishes that appear unusual to match or for customers directly requesting a sample, a finish sample will be sent for approval prior to entering the order.

Custom finishes requiring colored varnishes to create a painted look can only be applied to Maple veneer and require one extra week in addition to the standard lead time. Nucraft's standard black finish (G82) can be applied to all Nucraft standard veneers. Walnut is the standard black veneer. Other species must be specified when ordering.

Clear coat on a special veneer requires an approved sample.

Custom finishes carry a 10% upcharge per item, per finish, capped at \$2,200 List.

Custom finish upcharges are not applied to any item that is not wood. Example: casters, ganging connectors, power options..

Treatments

Note: Default veneer sheen will vary per finish and product. Default finish is bolded on pages vi-vii. If no direction is provided on incoming orders, default sheen will be selected. In addition, default veneer cut is noted in the price list. If no direction is provided on incoming orders, default cut will be selected.

Gloss: Gloss is a durable finish that tends to nicely mask normal wear and leaves wood grain visible to the eye. It achieves a medium gloss open pore appearance (40 – 50 sheen range). Finish numbers preceded by the letter "G" indicate a Gloss finish.

Matte: Like Gloss, Matte is durable, tends to nicely mask normal wear and leaves wood grain visible to the eye. It achieves a low luster, open pore appearance (10 – 20 sheen range). Finish numbers preceded by the letter "M" indicate a Matte finish.

Since each veneer type responds differently to both types of treatment, all will have a distinctive look and feel when finished. For example, a Walnut veneer with a Gloss treatment will remain much more textured than a Cherry veneer with the same treatment.

About the Wood

All Nucraft veneers are carefully selected for uniformity of color and grain. Still, wood is a natural substance and minor variations may occur due to its own uniqueness. Because of this, the furniture you receive may not be an exact match to our samples.

Nucraft takes great pride in our finish color consistency. However, wood is a natural product that will have color variation within a single piece of furniture, as well as from one piece to the next. Other factors also affect color over time, such as exposure to light (both intensity and duration). For example, lighter finishes cause more variation in colors over time.

In cases where a returning customer wants a precise match with existing furniture, we recommend sending a sample of the existing furniture finish. Please contact Nucraft Customer Service to determine an appropriate sample. This will ensure a finish match between old and new orders. This type of order is considered a control sample. There will be a 10% upcharge on an order of this type. Due to natural aging of veneers, natural finishes may vary.

Care and Maintenance of Wood Finishes

Our finish material is a crystal clear, urethane acrylic blend. This type of finish may be repaired in the field by a qualified refinisher.

Nucraft recommends using a damp cloth to clean your fine wood furniture. Always wipe with the grain of the wood. Should your wood furniture require a more thorough cleaning, we recommend using a mild cleaner such as Joy dish soap or Murphy's oil soap, thoroughly diluted in water (one part soap to thirty parts water). Water will not damage Nucraft's finish, but it may leave surface spots when it dries. To avoid this, dry the surface with a soft cloth after it is cleaned. Marks that cannot be removed with the cleaning methods above may be able to be removed using naphtha, a mild degreasing solvent.

Caution: while the use of polishes that contain wax, petroleum solvents or silicones may immediately enhance the "shine" of a product, it may also eventually remove the fine original finish applied in our factory. Silicone on the surface of wood may also make it very difficult to respray or refinish.

All Nucraft furniture is inspected and polished before it leaves our factory. In some instances, the packing materials may imprint on the factory polish. Cleaning and polishing the furniture once it is unpacked will normally restore the furniture to its original beauty.

In some cases, the rubber support feet used on the bottom of common office equipment (teleconferencing phones, laptops, microphones, copiers, etc.) can create unsightly marks in the surface of wood tops, due to oxidation of the lacquer finish. We suggest these machines be placed on a protective type of padding, such as felt.

Wood will fade as a result of exposure to UV light. This is particularly prevalent with light finishes. If color changes due to fading are a concern for your application, the impact can be minimized by selecting medium to dark stains for your wood surfaces. Our top coat includes a UV inhibitor which makes the finishes less prone to fading.



Laminates

Selected Formica®, Nevamar®, and Wilsonart® laminates are available on Training Tables, Conference Tables, Conference Room Furniture and select Occasional Tables. For standard laminate and wood pricing, refer to individual item pricing columns. It is important to note that wood grain laminates are unable to be grain matched over multi-piece table top applications.

Non-Standard Laminates and Linoleums

To order a color other than those on our list (see pages vi-vii), refer to Nevamar or Formica standard grade, matte texture laminate offerings and Forbo Furniture Linoleums (excluding manufacturers' non-standard matte offering).

Nucraft can support other laminate and linoleum options beyond what can be found as standard options on pages vi-viii. For pricing, please send a request to quotes@nucraft.com.

Care and Maintenance of Laminate and Novawrap

Laminate and Novawrap surfaces may be cleaned with a damp cloth and ordinary soap or non-abrasive household liquid detergent. Dry the surface with a clean cloth or soft paper towel to prevent streaks from appearing.

Care and Maintenance of Metal

Metal surfaces can be wiped with a damp cloth and rubbed dry. A mild non-abrasive household liquid detergent can be used if necessary. Regular maintenance of metal components, including tightening of fasteners and light lubrication of moving parts, will extend the life of your furniture.

Satin Etched Glass

Glass color may vary slightly on multi-piece conference table tops over 180" x 60" when satin etched glass is specified due to the iron content and etching process of the glass.

Care and Maintenance of Glass

Clear or frosted glass may be cleaned with commercial glass cleaner. Be sure to use a lint-free cloth if cleaning the frosted side of the glass.

Stone and Solid Surface Material

Despite its reputation for durability, natural stone can easily be broken during handling and/or installation if proper techniques are not followed. In addition, Nucraft is not responsible for the installation of natural stone or solid surface materials on its products. Therefore, installers specifically trained in the installation of these materials must be utilized to ensure a quality installation. Nucraft shall not be liable for any damages incurred during the handling and/or installation of natural stone or solid surface materials on its products.

Care and Maintenance of Granite

Granite surfaces may be cleaned with a damp cloth and ordinary soap or non-abrasive household liquid detergent. Dry the surface with a clean cloth or soft paper towel to prevent streaks from appearing.

Care and Maintenance of Leather

Genuine leather requires very little care. Nucraft recommends that leather be dusted regularly. If a more thorough cleaning is needed, use lukewarm water and a mild, non-abrasive soap. Generate some lather and lightly rub the surface with cheesecloth. Rinse off any soap film with clean water and towel dry. The leather may dry dull. To restore the leather to a normal gloss, rub it with a clean towel. Never use furniture polish, oil, varnish or ammonia. Saddle soap may be used to prevent the leather from becoming brittle or cracked and to maintain the original supple finish.

Touch Up Finish Kits

Model #	Description	Price
KIT-M	Metal Kit	85
KIT-P	Paint Kit	85
KIT-S	Stain Kit	85

REQUIRED INFORMATION:

(ORDER CANNOT BE ENTERED WITHOUT THIS INFORMATION)

- Kit model number
- Quantity of kits
- Specify finish (See pages vi-vii)

General Information:

- Touch-up kits must be ordered on a purchase order separate from Nucraft product due to Hazmat shipping

Retrofit & Replacements

If needing a partial placement or retrofit solution, please reach out to our quote team. Grain/color matched in a set.



VENEER

STANDARD

Default veneer sheen will vary per finish and were determined by a team of experts who reviewed the colorways to determine if gloss or matte best highlighted the natural characteristics of the species of wood and the color of the stain. Default finish is bolded. If no direction is provided, default sheen will be selected.

	Matte	Gloss
Rift Cut Oak		
Carbon	M03	G03
Flat Cut Oak		
Artisan	M68	G68
Coco	M67	G67
Dove	M66	G66
Dune	M05	G05
Midnight	M69	G69
Portobello	M7413	G7413
Winter	M70	G70
Flaky Oak		
Sahara	M61	G61
Cherry		
Auburn	M93	G93
Cognac	M21	G21
Walnut		
Marron	M35	G35
Mocha	M33	G33
Onyx	M82	G82
Otter	M31	G31
Zinc	M30	G30
Maple		
Natural Maple	M60	G60
Linea		
Euro Birch Linea	M09	G09
Oak Linea	M08	G08
Silver Birch Linea	M10	G10
Walnut Linea	M27	G27
Paldo		
Canyon	M77	G77
Paldo	M76	G76
Thicket	M75	G75

LAMINATE

Coordinating wood finish and edgeband options listed below.

		Solid Edge Band	
Solid Laminates			
Formica Brite White	459-58		R01
Formica Dover White	7197-58		R01
Formica Folkstone	927-58		R03
Formica Graphite	837-58		R05
Formica Graystone	464-58		R02
Formica Pearl	934-58		R02
Patterned Laminates			
Nevamar Calm Distinction	VA6001T		R05
Nevamar Cool Chic	VA7002T		R02
Nevamar Easy Elegance	VA5002T		R05
Nevamar Serene Stardom	VA5001T		R05
Wilsonart Sheer Mesh	4876-38		R02
Wilsonart Grey Mesh	4877-38		R02
Wilsonart Pewter Mesh	4878-38		R05
		Wood Finish	Woodgrain Edge Band
Wood Grain Laminates			
Formica Aged Ash	8844-58	M8844	R8844
Formica Blackened Legno	8848-58	M8848	R8848
Formica Bleached Legno	8845-58	M8845	R8845
Formica Chestnut Woodline	5884-58	M5884	R5884
Formica Espresso Pear	5489-58	M5489	R5489
Formica Natural Ash	8843-58	M8843	R8843
Formica Oiled Legno	8846-58	M8846	R8846
Formica Pecan Woodline	5883-58	M5883	R5883
Formica Planked Coffee Oak	7413-58	M7413	F7413
Formica Sand Maple	9237-58	G60	W7909
Formica Smoky Brown Pear	5488-58	M5488	R5488
Formica Thermo Walnut	6402-58	M6402	R6402
Formica Urban Planked Oak	9312-58	M9312	R9312
Formica Weathered Ash	8842-58	M8842	R8842
Formica White Ash	8841-58	M8841	R8841

GLASS*

	Satin	Gloss
Satin or Gloss Glass		
Black	BS	-
Clove	VS	VG
Meringue	MS	MG
Moonlight	MLS	MLG
Storm	STS	STG
Quill	QS	QG
White	WS	WG

*Available on Power Matrix only.



METAL

Powder Coat

Aged Bronze	A8010
Black	A44
Burnished	A8009
Cloud	A8004
Foil	A8006
Galaxy	A8007
Moonlight	A87
Satin Bronze	A8011
Shadow	A8005
Storm	A8012

Metal

Polished Chrome	(upcharge applies)	PC
-----------------	--------------------	----