

SUMMIT LECTERN™

Planning Guide + Price List

QUICK LINKS

[PLANNING GUIDE](#)

[SUMMIT LECTERN PRICING](#)

[GENERAL INFORMATION](#)

[FINISH INFORMATION](#)

[SURFACE MATERIALS](#)



TABLE OF CONTENTS

Click the shortcuts below to jump to each section.

General Information	ii-iii
Finish Information	iv-v
Surface Materials	vi-vii
Detail Overview	3
Dimensions	4
Platform Dimensions	5
Power Module and Logo Option	6
Summit Lectern Pricing	7-8



DETAIL OVERVIEW

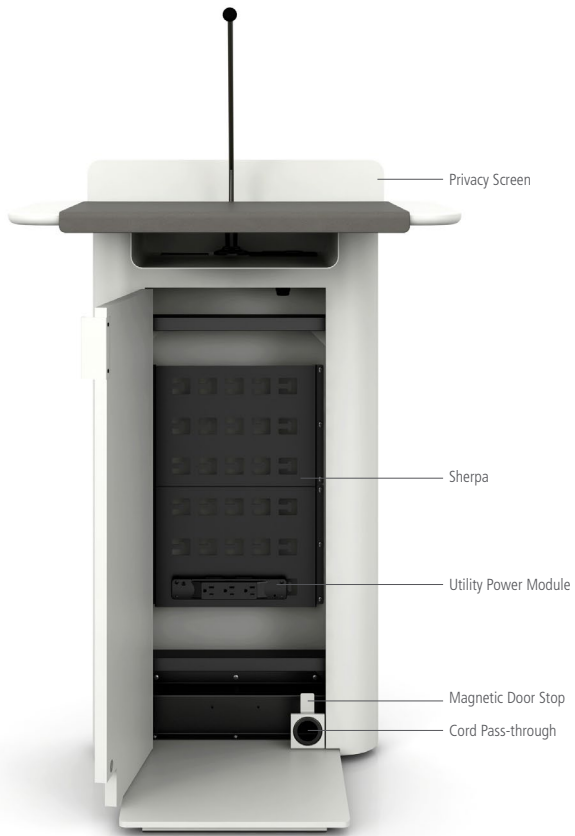

Fixed Height Lectern

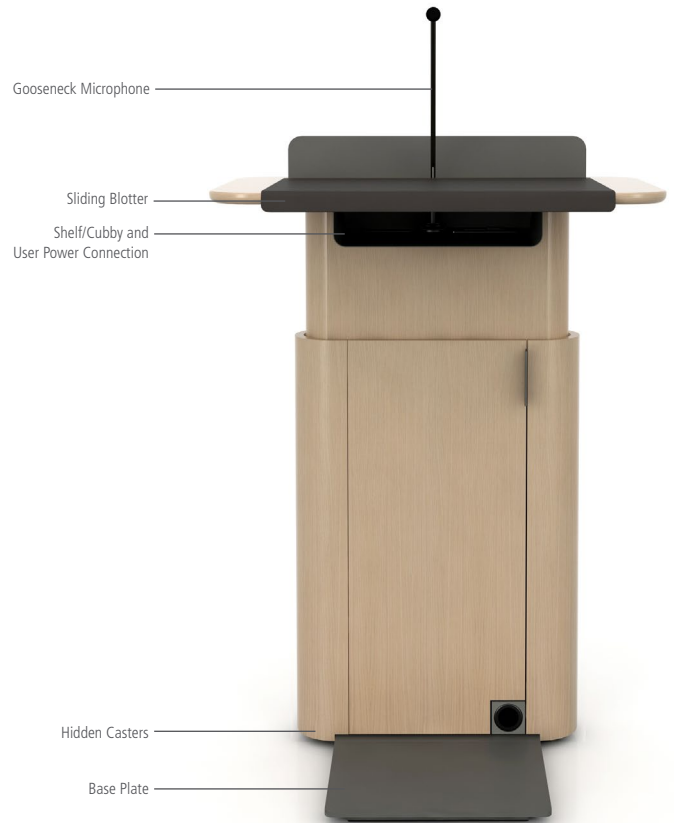

Height Adjustable Lectern

DIMENSIONS

FIXED HEIGHT LECTERN

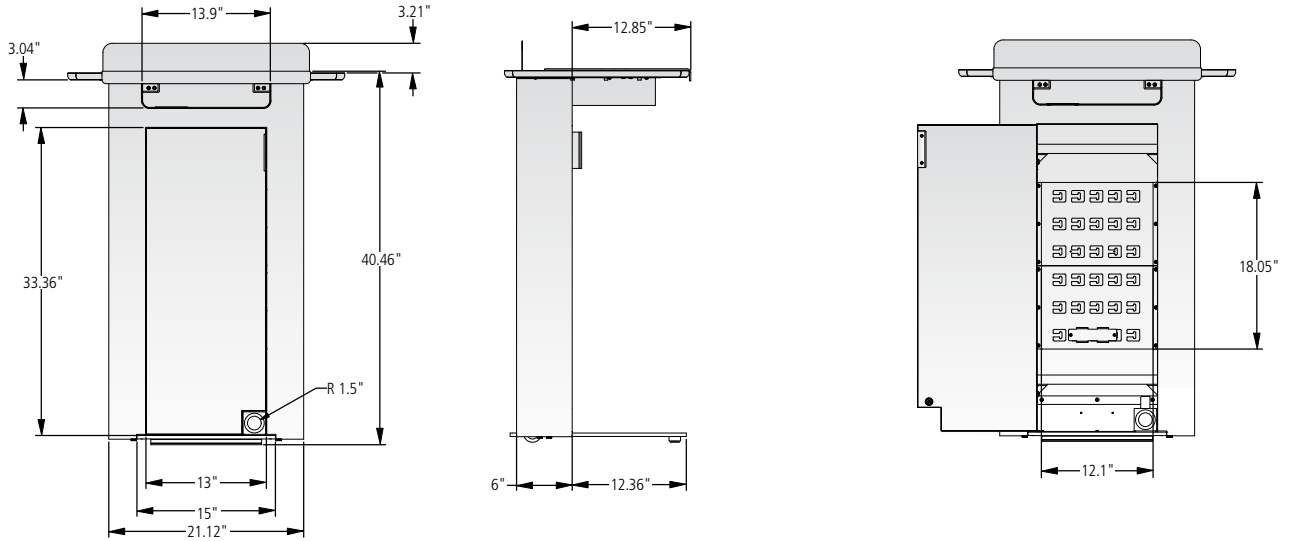

HEIGHT ADJUSTABLE LECTERN

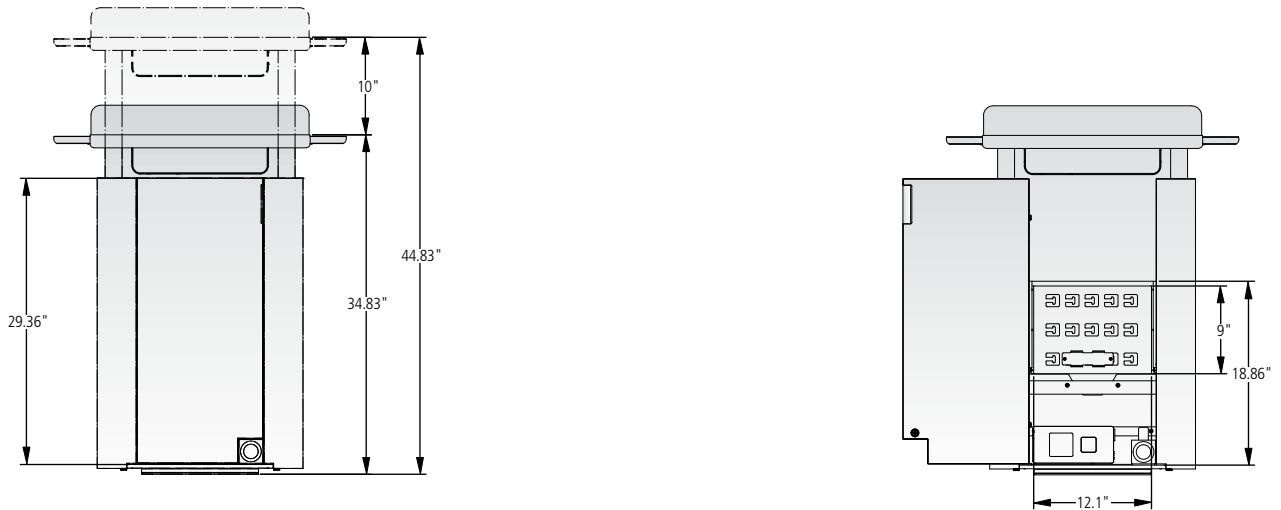



PLATFORM DIMENSIONS

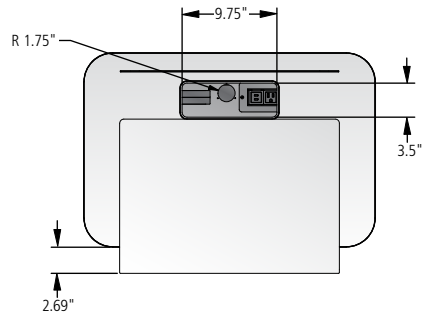
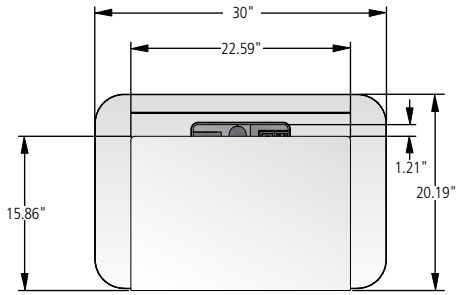

Height Adjustable Lectern Button

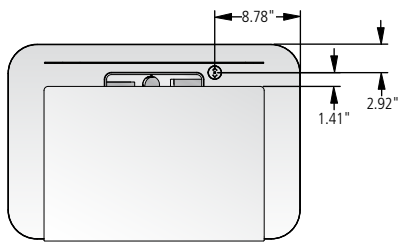



POWER MODULE AND LOGO OPTION

POWER MODULE

Includes:

- (1) Simplex Receptacle
- (2) 45w USB-C ports
- (2) Blank AAP faceplates
- 10' Power Cord

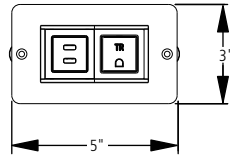

LOGO OPTION

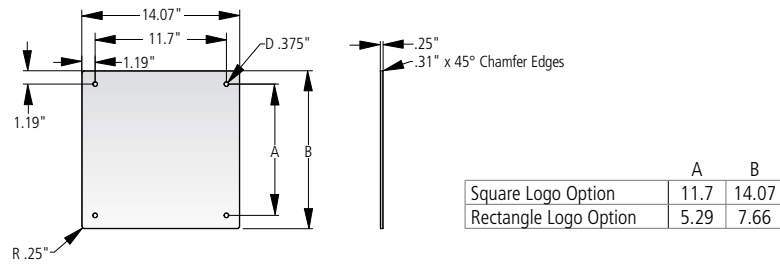

NOTE: Logo will be centered and glass plate will be mounted 2" from the top of the case.



FIXED HEIGHT OR HEIGHT ADJUSTABLE LECTERN



ADJUSTABLE HEIGHT

FIXED HEIGHT

SURFACE MATERIAL KEY

V Veneer
P Paint

SUMMIT LECTERN

MODEL #	W x D x H	DESCRIPTION	-V	-P
SMFH-3040	30 x 20 x 40	Fixed Height Lectern	8,000	8,000
SMHA-3034	30 x 20 x 34-44	Height Adjustable Lectern	12,000	12,000

OPTIONS	CODE	PRICE	NOTES
Power Options:			
White Power Module	Add -W	\$20	Standard power module is black
Microphone Options:			
Gooseneck Microphone (Shure CVG18)	Add -M	\$475	
Cutout Only	Add -MCO	\$100	
Logo Options:			
Rectangle Glass / Anodized	Add -R	\$1,750	
Square Glass / Anodized	Add -SQ	\$1,850	
Rectangle Glass / Powder Coated	Add -RP	\$1,800	
Square Glass / Powder Coated	Add -SQP	\$1,900	

GENERAL INFORMATION

- Includes 120 volt, 3 plug utility outlet strip
- Plate, pull, grommet, sherpa, internal structure, shelf, and privacy screen are powder coated. Sherpa and internal structure is always black.
- Shelf always contains power and AAP plate connections
- Door of lectern always contains grommet
- Painted case and top are painted over veneer
- Pull included on access door
- Lectern comes standard with hidden casters and sliding nylon plate
- Case includes sherpa equipment rack. Fixed height gets double sherpa.
- Power and data includes (1) simplex receptacle, (2) USB-c 45W ports, and (2) blank AAP plates
- Cord reaches 10' outside of case
- Plate, privacy screen, and shelf are only available in powder coat

REQUIRED INFORMATION (ORDER CANNOT BE ENTERED WITHOUT THIS INFORMATION)

- See appendix pages vi-vii for surface material options.
- Choose Wood Species & Finish, if -V option is selected
 - Choose Paint Finish, if -P option is selected
 - Choose Power and Button Finish, if Height Adjustable Lectern is specified
 - Choose Leather Blotter Finish
 - Choose Powder Coated Metal Finish, if applicable



POWER AND DATA OPTIONS

AV CONNECTORS AND MOUNTING PLATES	MODEL #	DESCRIPTION	STYLE	W x H	PRICE
	FLDF-1	Blank faceplate, single height	Single	3-1/2 x 5/8	74
	FLDF-2	One VGA 15-pin HD Female to Female Gender Changer, one 3.5mm Stereo Mini Jack to Solder Tabs	Single	3-1/2 x 5/8	259
	FLDF-3	One VGA 15-pin HD Female to Female Gender Changer	Single	3-1/2 x 5/8	203
	FLDF-4	One RJ-11 Female to Punch Down - Phone	Single	3-1/2 x 5/8	203
	FLDF-5	One RJ-45 Female to Female Barrel - Data	Single	3-1/2 x 5/8	166
	FLDF-6	Two RJ-45 Female to Female Barrels, single height	Single	3-1/2 x 5/8	223
	FLDF-7	Two RJ-45 Female to Punch Down for CAT 6 - AMP	Single	3-1/2 x 5/8	315
	FLDF-8	Two RJ-45 Female to Punch Down for CAT 6 - Leviton	Single	3-1/2 x 5/8	315
	FLDF-10	Two RJ-45 Female to Punch Down for CAT 6 - Panduit	Single	3-1/2 x 5/8	315
	FLDF-11	Two USB A Female to Two USB A Female on 10" Pigtails	Single	3-1/2 x 5/8	352
	FLDF-12	Blank faceplate, double height	Double	3-1/2 x 1-3/8	92
	FLDF-13	Two RJ-45 Female to Female Barrels, double height	Double	3-1/2 x 1-3/8	223
	FLDF-14	Cable Pass-Through Set - one top, one bottom	Double	3-1/2 x 1-3/8	389
	FLDF-15	One HDMI Female to Female Barrel	Single	3-1/2 x 5/8	259

GENERAL INFORMATION

- All connectors and faceplates are Extron® Architectural Adapter Plates (AAP)
- Faceplates are black



Appendix



GENERAL INFORMATION

This price book supercedes all previous versions.

Before placing your order, confirm you have all required information necessary. Lead times for orders begin after all required information is included and correct.

Delivery Information

We know lead times are important and sticking to them even more so. We work to maintain a 6-8 week lead time on all standard products in this book from receipt of a clean order. All orders are acknowledged with an approximate shipping date and will be invoiced with the price in effect at the date the purchase order is received.

Shipping charges are prepaid (within the continental U.S.). Therefore, pricing is a delivered price based on normal ground transportation. If you have special instructions, need to ship by air, or are shipping to Alaska or Hawaii, contact Nucraft Customer Service. Nucraft can also help arrange to have products blanket wrapped for an additional charge. Contact the Nucraft Customer Service team or specify it on your purchase order.

Minimum Freight Charge: Any order below \$2,800 net will be assessed a \$450 net minimum freight charge (one per order).

Orders are subject to acquiring the materials required for manufacturing. Fulfillment can be affected by strikes, fires, embargoes and acts of government. These elements are beyond our control.

Nucraft offers a variety of services to accommodate a wide range of delivery requirements. Availability of these services is dependent on a number of factors and may not be offered with all shipments. Examples of delivery services that have additional fees include:

- Specific date within our standard 3-5 day delivery window (for orders under \$50,000 net)
- Specific time of day, morning or afternoon (for orders under \$50,000 net)
- Delivery to a warehouse before delivery to its final destination (unless product is picked up at the warehouse)

Contact the Nucraft Customer Service team for availability and pricing on these services.

Freight Terms

Shipping charges for Nucraft products are prepaid for standard delivery in the continental United States. Standard delivery is defined as follows: Product is delivered on a 53' trailer being pulled by a long-haul tractor (total length of 85'). Facility will receive delivery Monday through Friday between the hours of 8:00 AM and 4:00 PM. Facility has docks with levelers and a fork truck for unloading. Product will be loaded on load bars two levels high. Receiving facility is responsible to have personnel on hand to unload the truck upon arrival, drivers do not unload. Delivery sites or times that do not meet this criteria will be accommodated, but will typically incur a charge to cover additional shipping costs. Please notify Nucraft in advance of the shipment if this is the case and the additional charge (if any) will be determined by Nucraft.

Product ships FOB dock. The customer obtains title to their product and materials, and assumes the risk of loss for them, upon shipment from Nucraft's facilities.

Storage

Nucraft has no storage facilities for finished product. If a customer cannot accept an order when it is ready for shipment, the customer must designate an alternative shipping address. If no address is provided, Nucraft may, at its discretion, transfer the product to storage. If product is transferred to an off-site storage facility, the customer may be charged for transportation to the facility and for any associated storage fees. Nucraft considers transfer of the product to a storage facility the equivalent of shipment, including invoicing and payment. Customers assume the risk of damage or loss during storage.

Transportation Times and Delays

Third party carriers that Nucraft contracts with will make reasonable efforts to accommodate requested delivery times and dates. Scheduled delivery appointments may, however, be delayed for a variety of reasons, including inclement weather, traffic, transportation equipment problems, and delays encountered at other delivery locations along the delivery route. Nucraft does not recommend scheduling activities that depend on the delivery appointment (for example, scheduling furniture installers to install furniture the day of the delivery appointment). Nucraft shall not be liable for any costs incurred as a result of a missed delivery appointment.

Shipment Damage Claims

Legal title to merchandise passes to the buyer upon acceptance by the carrier. **Inspect all cartons upon delivery.** Details of visible damage should be noted on the delivery receipt. Do not install product if damage is found upon inspection. The carrier should be notified by the buyer to inspect the merchandise, and file a claim immediately. If visible damage is not apparent, sign the delivery receipt "No visible damage." This will allow recourse for a concealed damage claim. Although most claims for transportation damages must be filed against the carrier within nine months of the date of delivery, concealed damage claims must be filed within 15 days of receipt.

Do not destroy packing materials until shipment has been inspected. Then proceed to file a claim with the carrier.

Failure to make any claims against Nucraft within 10 days shall constitute acceptance of the merchandise and a waiver of any defects, errors or shortages discovered upon inspection.

Cancellations

Cancellations must be reviewed by our Customer Service team. Because we build your products to order, orders cannot be cancelled once processing has begun. Processing includes but is not limited to development of shop drawings and other engineering drawings. If cancellation is approved, a processing fee of 20-100% will be assessed based on the status of the order.

Change Order Policy

Nucraft will make every attempt to honor any reasonable change request to product provided that the request is received prior to start of production. Change orders will be accepted only if the request is made in writing and received in time to make the change. Nucraft reserves the right to increase our acknowledged price and ship date if necessary to make the requested changes. Please submit any change order request to our Customer Service team. Nucraft will assess charges to the customer as stipulated in the following:

- Standard Orders: Change orders received prior to production will be charged \$400 net to cover administrative costs.
- Special Orders: Change orders received prior to production will be charged \$400 net to cover administrative costs. There may be additional costs associated with engineering labor required for the change order.
- Change orders received after production must be evaluated by Nucraft. If approved, the charge will be \$400 net plus any restocking charges accumulated. There may be additional costs associated with engineering and/or manufacturing labor, as well as material costs, required for the change order.



GENERAL INFORMATION

Repair Authorization

Prior written approval is required for repairs of merchandise charged to NuCraft. Failure to do so will result in customer funded repairs.

Payment Terms

Deposits are required at the time of order due to the custom nature of our products. See information regarding Cancellations above.

Credit terms are available to qualified customers. Please contact AR@NuCraft.com to start the application process. Note that the credit application process requires a valid sales tax exemption or resale tax certificate, Form W-9, and three current trade references.

Credit Card Payments are accepted via web portal. Please contact AR@NuCraft.com for payment instructions. Note that a 2% convenience fee will be added for using this payment method and no early pay discounts are allowed on credit card payments.

Warranty

NuCraft Furniture is warranted to be free from defects in materials and workmanship for a period of ten years of single shift use. Limitations include:

- Mechanical Devices such as latches, casters, and other moving components are warranted for five years of the date of original delivery.
- Height adjustable components are warranted for two years of the date of original delivery.
- The following are warranted for one year of the date of original delivery:
 - Textiles
 - Electrical Components
 - Refrigeration Units
 - Custom Products not described in NuCraft's Catalogue

This warranty is applicable only if furniture is properly installed and maintained in an office environment. This warranty extends only to products manufactured and sold in North America and only to original purchasers acquiring new NuCraft product through authorized dealers or approved sellers.

During this warranty period, NuCraft's sole obligation is to repair or replace, at NuCraft's discretion, products which prove to be defective during the warranty period.

This warranty does not cover:

- Damage caused by a carrier.
- Damage from user modification, misuse, abuse, accident, or negligence.
- Customer's Own Material (COM) specified by the customer that is not a standard product offering.
- Color, grain, or texture of wood and other covering material.

NuCraft extends no other warranties, expressed or implied, including warranty of merchantability or fitness for a particular purpose. NuCraft shall not be liable for loss of time, inconvenience, commercial loss, incidental or consequential damages.

Environmental Statement

NuCraft is committed to supporting responsible environmental policies and practices in all that we do. We strive for sustainability, weighing our business decisions against the costs to the ecological, social and economic systems they affect.

Our products are manufactured to meet the credit requirements of the U.S. Green Building Council's LEED rating systems in one or more of the following categories:

- Recycled Content
- Certified Wood
- Low-Emitting Materials

Computer Aided Planning

NuCraft products and pricing are available on CD via 2020 Cap, an AutoCAD®-based space planning tool.

2020 Cap is an integrated software system developed specifically for interior designers and facility planners to enhance workplace performance. This modern suite of applications works together seamlessly, in concert. Navigate catalogs, select products, design in plan view and 3D, assign options, create worksheets and build a project where you want, when you want. Take your pick. It's dynamic and interactive. Design projects are a work in progress. And now you can perform any of the many discrete tasks that go into a project any time, any place.

For additional information, you may contact 2020 Cap direct at 800-227-0038.

iSpec®

NuCraft offers a free online product configuration and specification service that saves you time and allows you to be creative while leaving the nuts and bolts to someone else. No specific software is required, nor is there any learning curve. This service applies to all NuCraft products. For additional information, call 1-877-NUCRAFT and ask for the iSpec Team or log on to www.nucraft.com/ispec.



FINISH INFORMATION

Surface Materials Palette

We crafted our materials palette using the same demanding standards that distinguish our furniture. Thoughtful design and attention to every detail elevate your possibilities.

Anchored by NuCraft veneers, unrivaled for clarity, quality, and depth of finish, our collection of surface materials comprises a sophisticated set of balanced elements that supports your design vision.

Some elements have their roots in NuCraft’s rich heritage. Others are new materials and reflect current trends and taste. Together, they ensure that you’re ready for today and positioned well for the future. Beautifully.

Custom Finishes

NuCraft specializes in expert custom finish matching. For a nominal upcharge we can provide custom finishes, and we are frequently asked to match the finishes of other furniture manufacturers. For finishes that appear unusual to match or for customers directly requesting a sample, a finish sample will be sent for approval prior to entering the order.

Custom finishes requiring colored varnishes to create a painted look can only be applied to Maple veneer and require one extra week in addition to the standard lead time. NuCraft’s standard black finish (G82) can be applied to all NuCraft standard veneers. Walnut is the standard black veneer. Other species must be specified when ordering.

Clear coat on a special veneer requires an approved sample.

Custom finishes carry a 10% upcharge per item, per finish, capped at \$1,975 List.

Custom finish upcharges are not applied to any item that is not wood. Example: casters, ganging connectors, power options..

Treatments

Note: Default veneer sheen will vary per finish and product. Default finish is bolded on pages vi-vii. If no direction is provided on incoming orders, default sheen will be selected. In addition, default veneer cut is noted in the price list. If no direction is provided on incoming orders, default cut will be selected.

Gloss: Gloss is a durable finish that tends to nicely mask normal wear and leaves wood grain visible to the eye. It achieves a medium gloss open pore appearance (40 – 50 sheen range). Finish numbers preceded by the letter “G” indicate a Gloss finish.

Matte: Like Gloss, Matte is durable, tends to nicely mask normal wear and leaves wood grain visible to the eye. It achieves a low luster, open pore appearance (10 – 20 sheen range). Finish numbers preceded by the letter “M” indicate a Matte finish.

Since each veneer type responds differently to both types of treatment, all will have a distinctive look and feel when finished. For example, a Walnut veneer with a Gloss treatment will remain much more textured than a Cherry veneer with the same treatment.

About the Wood

All NuCraft veneers are carefully selected for uniformity of color and grain. Still, wood is a natural substance and minor variations may occur due to its own uniqueness. Because of this, the furniture you receive may not be an exact match to our samples.

NuCraft takes great pride in our finish color consistency. However, wood is a natural product that will have color variation within a single piece of furniture, as well as from one piece to the next. Other factors also affect color over time, such as exposure to light (both intensity and duration). For example, lighter finishes cause more variation in colors over time.

In cases where a returning customer wants a precise match with existing furniture, we recommend sending a sample of the existing furniture finish. Please contact NuCraft Customer Service to determine an appropriate sample. This will ensure a finish match between old and new orders. This type of order is considered a control sample. There will be a 10% upcharge on an order of this type. Due to natural aging of veneers, natural finishes may vary.

Care and Maintenance of Wood Finishes

Our finish material is a crystal clear, urethane acrylic blend. This type of finish may be repaired in the field by a qualified refinisher.

NuCraft recommends using a damp cloth to clean your fine wood furniture. Always wipe with the grain of the wood. Should your wood furniture require a more thorough cleaning, we recommend using a mild cleaner such as Joy dish soap or Murphy’s oil soap, thoroughly diluted in water (one part soap to thirty parts water). Water will not damage NuCraft’s finish, but it may leave surface spots when it dries. To avoid this, dry the surface with a soft cloth after it is cleaned. Marks that cannot be removed with the cleaning methods above may be able to be removed using naphtha, a mild degreasing solvent.

Caution: while the use of polishes that contain wax, petroleum solvents or silicones may immediately enhance the “shine” of a product, it may also eventually remove the fine original finish applied in our factory. Silicone on the surface of wood may also make it very difficult to respray or refinish.

All NuCraft furniture is inspected and polished before it leaves our factory. In some instances, the packing materials may imprint on the factory polish. Cleaning and polishing the furniture once it is unpacked will normally restore the furniture to its original beauty.

In some cases, the rubber support feet used on the bottom of common office equipment (teleconferencing phones, laptops, microphones, copiers, etc.) can create unsightly marks in the surface of wood tops, due to oxidation of the lacquer finish. We suggest these machines be placed on a protective type of padding, such as felt.

Wood will fade as a result of exposure to UV light. This is particularly prevalent with light finishes. If color changes due to fading are a concern for your application, the impact can be minimized by selecting medium to dark stains for your wood surfaces. Our top coat includes a UV inhibitor which makes the finishes less prone to fading.



FINISH INFORMATION

Laminates

Selected Formica® and Nevamar® laminates are available on Training Tables, Conference Tables, Conference Room Furniture and select Occasional Tables. For standard laminate and wood pricing, refer to individual item pricing columns.

Non-Standard Laminates and Linoleums

To order a color other than those on our list (see pages vi-vii), refer to Nevamar or Formica standard grade, matte texture laminate offerings and Forbo Furniture Linoleums (excluding manufacturers' non-standard matte offering).

- For approved non-standard laminates with a hardwood edge, the upcharge is 10% of the base price per laminate color with a minimum of \$500 and capped at \$1975.
- For approved non-standard laminate with a standard ABS edge, the upcharge is \$175 per laminate color.
- For approved non-standard laminates with a non standard ABS edge, please contact customer service.

To ensure your non standard laminate is on our approved list, please contact customer service. Add one week to the lead-time for all non-standard laminate and linoleum orders. Call the Nucraft Customer Service team for quotes on premium grades and laminates. Mirror and metal laminates are not available.

Care and Maintenance of Laminate and Novawrap

Laminate and Novawrap surfaces may be cleaned with a damp cloth and ordinary soap or non-abrasive household liquid detergent. Dry the surface with a clean cloth or soft paper towel to prevent streaks from appearing.

Care and Maintenance of Metal

Metal surfaces can be wiped with a damp cloth and rubbed dry. A mild non-abrasive household liquid detergent can be used if necessary. Regular maintenance of metal components, including tightening of fasteners and light lubrication of moving parts, will extend the life of your furniture.

Satin Etched Glass

Glass color may vary slightly on multi-piece conference table tops over 180" x 60" when satin etched glass is specified due to the iron content and etching process of the glass.

Care and Maintenance of Glass

Clear or frosted glass may be cleaned with commercial glass cleaner. Be sure to use a lint-free cloth if cleaning the frosted side of the glass.

Stone and Solid Surface Material

Despite its reputation for durability, natural stone can easily be broken during handling and/or installation if proper techniques are not followed. In addition, Nucraft is not responsible for the installation of natural stone or solid surface materials on its products. Therefore, installers specifically trained in the installation of these materials must be utilized to ensure a quality installation. Nucraft shall not be liable for any damages incurred during the handling and/or installation of natural stone or solid surface materials on its products.

Care and Maintenance of Granite

Granite surfaces may be cleaned with a damp cloth and ordinary soap or non-abrasive household liquid detergent. Dry the surface with a clean cloth or soft paper towel to prevent streaks from appearing.

Care and Maintenance of Leather

Genuine leather requires very little care. Nucraft recommends that leather be dusted regularly. If a more thorough cleaning is needed, use lukewarm water and a mild, non-abrasive soap. Generate some lather and lightly rub the surface with cheesecloth. Rinse off any soap film with clean water and towel dry. The leather may dry dull. To restore the leather to a normal gloss, rub it with a clean towel. Never use furniture polish, oil, varnish or ammonia. Saddle soap may be used to prevent the leather from becoming brittle or cracked and to maintain the original supple finish.

Touch Up Finish Kits

Model #	Description	Price
KIT-M	Metal Kit	80
KIT-P	Paint Kit	80
KIT-S	Stain Kit	80

REQUIRED INFORMATION: (ORDER CANNOT BE ENTERED WITHOUT THIS INFORMATION)

- Kit model number
- Quantity of kits
- Specify finish (See pages vi-vii)

General Information:

- Touch-up kits must be ordered on a purchase order separate from Nucraft product due to Hazmat shipping



SUMMIT LECTERN SURFACE MATERIALS

WOOD FINISHES

STANDARD

Default veneer sheen will vary per finish and were determined by a team of experts who reviewed the colorways to determine if gloss or matte best highlighted the natural characteristics of the species of wood and the color of the stain. Default finish is bolded. If no direction is provided, default sheen will be selected. Standard veneer cuts for the Summit Lectern are quarter and rift. Flat cut is a special.

	Matte	Gloss
Ash		
Blanco	M44	G44
Char	M50	G50
Oak		
Carbon	M03	G03
Dune	M05	G05
Portobello	M7413	G7413
Flaky Oak		
Sahara	M61	G61
Walnut		
Marron	M35	G35
Mocha	M33	G33
Zinc	M30	G30
Onyx	M82	G82
Otter	M31	G31
Maple		
Natural Maple	M60	G60
Linea		
Oak Linea	M08	G08
Walnut Linea	M27	G27
Euro Birch Linea	M09	G09
Silver Birch Linea	M10	G10
Paldao		
Thicket	M75	G75
Paldao	M76	G76
Canyon	M77	G77

METAL FINISHES

Powder Coat

Aged Bronze	A8010
Black	A44
Burnished	A8009
Cloud	A8004
Foil	A8006
Galaxy	A8007
Satin Bronze	A8011
Shadow	A8005
Storm	A8012

Metal

Clear Anodized	CA
----------------	----

PAINTS

Aged Bronze	S8010
Black	S44
Burnished	S88
Cloud	S8004
Foil	S8006
Galaxy	S8007
Moonlight	S87
Satin Bronze	S8011
Shadow	S8005
Storm	S8012

Paint to Match

To request a custom paint color, contact Nucraft Customer Service. A paint sample must be matched and approved prior to order.

LEATHER

Spinneybeck Vincenza | VZ | Grade E

Salvi	2101
Ponte Furo	2102
Villabalzana	2108
Castello di Bellaguardia	2112
Scamozzi	2114
Peralolo	2115
Costozza	2116
Nocciola	2117
Appla Antica	2120
Cinque Terra	2122
Black	BLCK