

TALIS™

Planning Guide + Price List

QUICK LINKS

[TALIS PRICING](#)

[GENERAL INFORMATION](#)

[FINISH INFORMATION](#)

[SURFACE MATERIALS](#)



END TABLE, CONSOLE AND BENCH

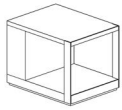

END TABLE

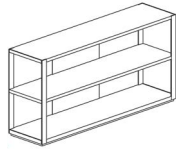

CONSOLE

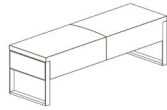

BENCH

SURFACE MATERIAL KEY

- VC Metal Legs
- VL Polished Stainless Legs
- VB Blackened Nickel Legs

END TABLE

MODEL #	W x D x H	DESCRIPTION	-VC	-VL	-VB
TAT-2116	16 x 21 x 16	End Table	4,463	5,799	6,692
TAT-2619	20 x 26 x 19	End Table	4,619	6,002	6,926

CONSOLE

MODEL #	W x D x H	DESCRIPTION	-VC	-VL	-VB
TAC-6029NN	60 x 15 x 29	Open Console	5,303	6,892	7,952

GENERAL INFORMATION

- Laminate not available
- All products ship assembled
- Back of Console is unfinished
- Quarter cut veneers on all veneered surfaces, with the exception of the following finishes:
 - Dune and Portobello (Flat Cut Oak)
 - Cognac and Auburn (Flat Cut Cherry)
 - Carbon (Rift Cut Oak)

REQUIRED INFORMATION (ORDER CANNOT BE ENTERED WITHOUT THIS INFORMATION)

See appendix page vi for surface material options.

- Choose Wood Species & Finish
- Choose Metal Finish
- Minimum Freight Charge: Add \$390 net per order below \$2,500 net

BENCH

MODEL #	W x D x H	YARDAGE	-COM	-A	-B	-C	-D	-E	-F	-G	-H
Powder Coat											
TAB-6018-C	60 x 18 x 18	3-1/2	6,629	6,811	6,900	6,989	7,080	7,170	7,259	7,350	7,384
TAB-7218-C	72 x 18 x 18	4	6,868	7,076	7,179	7,279	7,384	7,488	7,586	7,690	7,732
Polished Stainless											
TAB-6018-L	60 x 18 x 18	3-1/2	7,952	8,133	8,226	8,312	8,402	8,494	8,582	8,673	8,708
TAB-7218-L	72 x 18 x 18	4	8,241	8,450	8,553	8,654	8,757	8,861	8,961	9,063	9,105
Blackened Nickel											
TAB-6018-B	60 x 18 x 18	3-1/2	9,277	9,459	9,550	9,635	9,728	9,819	9,906	9,998	10,033
TAB-7218-B	72 x 18 x 18	4	9,612	9,822	9,924	10,024	10,129	10,231	10,331	10,437	10,479

GENERAL INFORMATION

- All products ship assembled
- Quarter cut veneers on all veneered surfaces, with the exception of the following finishes:
 - Dune and Portobello (Flat Cut Oak)
 - Cognac and Auburn (Flat Cut Cherry)
 - Carbon (Rift Cut Oak)
- Note: All Graded-In and COM fabrics will require pre-approval for use on Talis benches. Please contact Nucraft Customer Service for assistance with this process. When choosing a fabric, consult the ACT Voluntary Performance Guidelines (www.contracttextiles.org) for assistance in evaluating certain characteristics of contract textiles. These guidelines assure that the fabrics you specify perform up to the contract standards and pass all applicable testing.

REQUIRED INFORMATION (ORDER CANNOT BE ENTERED WITHOUT THIS INFORMATION)

See appendix page vi-vii for surface material options.

- Choose Fabric
- Choose Powder Coat Metal Finish
- Minimum Freight Charge: Add \$390 net per order below \$2,500 net



FREESTANDING POWER: CHARGING CUBE AND TECH ZONE

CHARGING CUBE

Charging Cube addresses the need for portable power. The ability to take this device anywhere for collaboration and easy connectivity makes the Charging Cube ideal for those who appreciate flexibility in their workspace.

The Charging Cube can be placed anywhere, and allow up to three devices to be charged at once.

- Two 4 amp USB-A fast charging ports
- One 4 amp USB-C smart charging port
- 11,600 mAh battery capacity
- Charges completely in 4 hours

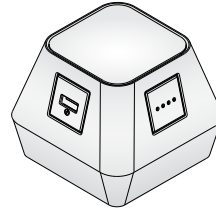

Charging Cube - Top View

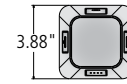

Charging Cube - Side View



TECH ZONE

Simple, easy to use and portable, this freestanding table top power option allows you to easily charge all of your devices.

Available in two configurations with a variety of power and data connectivity options. Includes a 72"-long plug-in infeed cord.

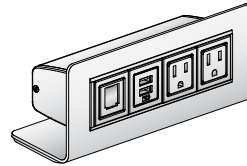

Tech Zone - Side View

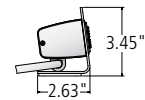

ZONE-USB

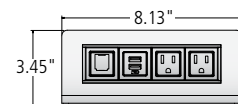

ZONE-DATA



ZONE-USB

Includes two simplex receptacles, one data port and one dual charging USB-A charging port

ZONE-DATA

Includes two simplex receptacles and two open data ports



FREESTANDING POWER: CHARGING STAND

BATTERY-POWERED CHARGING STAND

At table height, this battery-powered unit provides multiple charging options for collaboration anywhere with cordless power.

- Three 2 amp USB-A charging ports
- One USB-C (18W) charging port

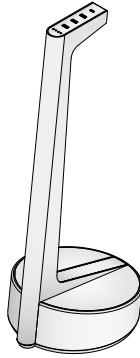

Battery-Powered Charging Stand Side View

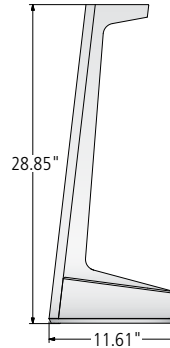

Battery-Powered Charging Stand Top View

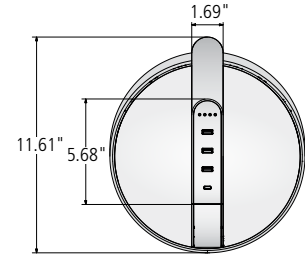

CORDED CHARGING STAND

The corded unit offers various configurations to fit your needs, while still offering easy mobility. Includes a 10'-long plug-in infeed cord.

Three configurations to choose from:

STAND-1C

One simplex receptacle and two USB-A ports, and one USB-C port

STAND-3C

Three simplex receptacles, two USB-A ports, and one USB-C port

STAND-4C

Four simplex receptacles, two USB-A ports and one USB-C port

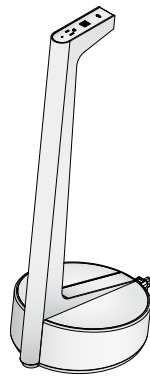

Corded Charging Stand Side View

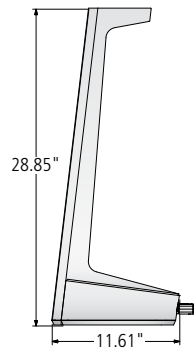

Corded Charging Stand Top View

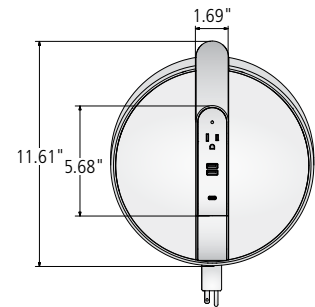

Base Plate Configuration Options

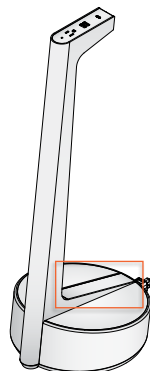

STAND-1C



STAND-3C



STAND-4C





FREESTANDING POWER OPTIONS

CHARGING STAND (BATTERY-POWERED)	MODEL #	DESCRIPTION	SIMPLEX OUTLETS	USB-A PORTS	USB-C PORTS	PRICE
	STAND-B-W	Battery-Powered White Unit	-	3	1	2,196
	STAND-B-B	Battery-Powered Black Unit	-	3	1	2,196

GENERAL INFORMATION

- Three ports for USB-A and one 18 Watt USB-C
- Charging cord included
- LED lights on top of the unit indicate charge level of the battery. When all 4 lights are on, the battery is fully charged.
- Uses a 40 Amp Hour battery with a 128 Watt Hour capacity. For optimal use, it should be charged every night.
- Charging capacities are estimated, based on charging from no power to full power.
 - 10-12 smart phones
 - 8-10 small tablets (5-7" in size)
 - 4 large tablets (9-11" in size)
- White unit is a combination of White aluminum on the base and neck area, and plastic in the Fog color for the trim inserts
- Weight: 12lbs

CHARGING STAND (CORDED)	MODEL #	DESCRIPTION	SIMPLEX OUTLETS	USB-A PORTS	USB-C PORTS	PRICE
	STAND-1C-W	Corded White Unit	1	2	1	967
	STAND-3C-W	Corded White Unit	3	2	1	976
	STAND-4C-W	Corded White Unit	4	2	1	996
	STAND-1C-B	Corded Black Unit	1	2	1	967
	STAND-3C-B	Corded Black Unit	3	2	1	976
	STAND-4C-B	Corded Black Unit	4	2	1	996

GENERAL INFORMATION

- 10' Plug-In Infeed Cord
- Capable of charging laptops, tablets and mobile phones simultaneously
- STAND-4C version includes a circuit breaker in the base
- Weight: 10lbs

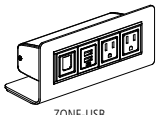
TECH ZONE	MODEL #	DESCRIPTION	SIMPLEX OUTLETS	OPEN DATA PORTS	DUAL CHARGING USB	PRICE
	ZONE-DATA	(2) Simplex receptacles (2) Open data ports	2	2	-	324
	ZONE-USB	(2) Simplex receptacles (1) Dual charging USB (1) Open data port	2	1	1	388

GENERAL INFORMATION

- 72" long plug-in infeed cord
- Finish is black
- Includes a Voice/Data Adapter Kit to accept couplers and jacks when required



ZONE-DATA



ZONE-USB

CHARGING CUBE	MODEL #	DESCRIPTION	PRICE
	CUBE-W	White Power Cube	379
	CUBE-B	Black Power Cube	379

GENERAL INFORMATION

- Includes (3) 2 Amp USB charging ports
- The Cube can be recharged completely in 4.5 hours



Appendix



GENERAL INFORMATION

This price book supercedes all previous versions.

Before placing your order, confirm you have all required information necessary. Lead times for orders begin after all required information is included and correct.

Delivery Information

We know lead times are important and sticking to them even more so. We work to maintain a 6-8 week lead time on all standard products in this book from receipt of a clean order. All orders are acknowledged with an approximate shipping date and will be invoiced with the price in effect at the date the purchase order is received.

Shipping charges are prepaid (within the continental U.S.). Therefore, pricing is a delivered price based on normal ground transportation. If you have special instructions, need to ship by air, or are shipping to Alaska or Hawaii, contact Nucraft Customer Service. Nucraft can also help arrange to have products blanket wrapped for an additional charge. Contact the Nucraft Customer Service team or specify it on your purchase order.

Minimum Freight Charge: Any order below \$2,700 net will be assessed a \$425 net minimum freight charge (one per order).

Orders are subject to acquiring the materials required for manufacturing. Fulfillment can be affected by strikes, fires, embargoes and acts of government. These elements are beyond our control.

Nucraft offers a variety of services to accommodate a wide range of delivery requirements. Availability of these services is dependent on a number of factors and may not be offered with all shipments. Examples of delivery services that have additional fees include:

- Specific date within our standard 3-5 day delivery window (for orders under \$50,000 net)
- Specific time of day, morning or afternoon (for orders under \$50,000 net)
- Delivery to a warehouse before delivery to its final destination (unless product is picked up at the warehouse)

Contact the Nucraft Customer Service team for availability and pricing on these services.

Freight Terms

Shipping charges for Nucraft products are prepaid for standard delivery in the continental United States. Standard delivery is defined as follows: Product is delivered on a 53' trailer being pulled by a long-haul tractor (total length of 85'). Facility will receive delivery Monday through Friday between the hours of 8:00 AM and 4:00 PM. Facility has docks with levelers and a fork truck for unloading. Product will be loaded on load bars two levels high. Receiving facility is responsible to have personnel on hand to unload the truck upon arrival, drivers do not unload. Delivery sites or times that do not meet this criteria will be accommodated, but will typically incur a charge to cover additional shipping costs. Please notify Nucraft in advance of the shipment if this is the case and the additional charge (if any) will be determined by Nucraft.

Product ships FOB dock. The customer obtains title to their product and materials, and assumes the risk of loss for them, upon shipment from Nucraft's facilities.

Storage

Nucraft has no storage facilities for finished product. If a customer cannot accept an order when it is ready for shipment, the customer must designate an alternative shipping address. If no address is provided, Nucraft may, at its discretion, transfer the product to storage. If product is transferred to an off-site storage facility, the customer may be charged for transportation to the facility and for any associated storage fees. Nucraft considers transfer of the product to a storage facility the equivalent of shipment, including invoicing and payment. Customers assume the risk of damage or loss during storage.

Transportation Times and Delays

Third party carriers that Nucraft contracts with will make reasonable efforts to accommodate requested delivery times and dates. Scheduled delivery appointments may, however, be delayed for a variety of reasons, including inclement weather, traffic, transportation equipment problems, and delays encountered at other delivery locations along the delivery route. Nucraft does not recommend scheduling activities that depend on the delivery appointment (for example, scheduling furniture installers to install furniture the day of the delivery appointment). Nucraft shall not be liable for any costs incurred as a result of a missed delivery appointment.

Shipment Damage Claims

Legal title to merchandise passes to the buyer upon acceptance by the carrier. **Inspect all cartons upon delivery.** Details of visible damage should be noted on the delivery receipt. Do not install product if damage is found upon inspection. The carrier should be notified by the buyer to inspect the merchandise, and file a claim immediately. If visible damage is not apparent, sign the delivery receipt "No visible damage." This will allow recourse for a concealed damage claim. Although most claims for transportation damages must be filed against the carrier within nine months of the date of delivery, concealed damage claims must be filed within 15 days of receipt.

Do not destroy packing materials until shipment has been inspected. Then proceed to file a claim with the carrier.

Failure to make any claims against Nucraft within 10 days shall constitute acceptance of the merchandise and a waiver of any defects, errors or shortages discovered upon inspection.

Cancellations

Cancellations must be reviewed by our Customer Service team. Because we build your products to order, orders cannot be cancelled once processing has begun. Processing includes but is not limited to development of shop drawings and other engineering drawings. If cancellation is approved, a processing fee of 20-100% will be assessed based on the status of the order.

Change Order Policy

Nucraft will make every attempt to honor any reasonable change request to product provided that the request is received prior to start of production. Change orders will be accepted only if the request is made in writing and received in time to make the change. Nucraft reserves the right to increase our acknowledged price and ship date if necessary to make the requested changes. Please submit any change order request to our Customer Service team. Nucraft will assess charges to the customer as stipulated in the following:

- Standard Orders: Change orders received prior to production will be charged \$400 net to cover administrative costs.
- Special Orders: Change orders received prior to production will be charged \$400 net to cover administrative costs. There may be additional costs associated with engineering labor required for the change order.
- Change orders received after production must be evaluated by Nucraft. If approved, the charge will be \$400 net plus any restocking charges accumulated. There may be additional costs associated with engineering and/or manufacturing labor, as well as material costs, required for the change order.



GENERAL INFORMATION

Repair Authorization

Prior written approval is required for repairs of merchandise charged to NuCraft. Failure to do so will result in customer funded repairs.

Payment Terms

Deposits are required at the time of order due to the custom nature of our products. See information regarding Cancellations above.

Credit terms are available to qualified customers. Please contact AR@NuCraft.com to start the application process. Note that the credit application process requires a valid sales tax exemption or resale tax certificate, Form W-9, and three current trade references.

Credit Card Payments are accepted via web portal. Please contact AR@NuCraft.com for payment instructions. Note that a 2% convenience fee will be added for using this payment method and no early pay discounts are allowed on credit card payments.

Warranty

NuCraft Furniture is warranted to be free from defects in materials and workmanship for a period of ten years of single shift use. Limitations include:

- Mechanical Devices such as latches, casters, and other moving components are warranted for five years of the date of original delivery.
- Height adjustable components are warranted for two years of the date of original delivery.
- The following are warranted for one year of the date of original delivery:
 - Textiles
 - Electrical Components
 - Refrigeration Units
 - Custom Products not described in NuCraft's Catalogue

This warranty is applicable only if furniture is properly installed and maintained in an office environment. This warranty extends only to products manufactured and sold in North America and only to original purchasers acquiring new NuCraft product through authorized dealers or approved sellers.

During this warranty period, NuCraft's sole obligation is to repair or replace, at NuCraft's discretion, products which prove to be defective during the warranty period.

This warranty does not cover:

- Damage caused by a carrier.
- Damage from user modification, misuse, abuse, accident, or negligence.
- Customer's Own Material (COM) specified by the customer that is not a standard product offering.
- Color, grain, or texture of wood and other covering material.

NuCraft extends no other warranties, expressed or implied, including warranty of merchantability or fitness for a particular purpose. NuCraft shall not be liable for loss of time, inconvenience, commercial loss, incidental or consequential damages.

Environmental Statement

NuCraft is committed to supporting responsible environmental policies and practices in all that we do. We strive for sustainability, weighing our business decisions against the costs to the ecological, social and economic systems they affect.

Our products are manufactured to meet the credit requirements of the U.S. Green Building Council's LEED rating systems in one or more of the following categories:

- Recycled Content
- Certified Wood
- Low-Emitting Materials

Computer Aided Planning

NuCraft products and pricing are available on CD via 2020 Cap, an AutoCAD®-based space planning tool.

2020 Cap is an integrated software system developed specifically for interior designers and facility planners to enhance workplace performance. This modern suite of applications works together seamlessly, in concert. Navigate catalogs, select products, design in plan view and 3D, assign options, create worksheets and build a project where you want, when you want. Take your pick. It's dynamic and interactive. Design projects are a work in progress. And now you can perform any of the many discrete tasks that go into a project any time, any place.

For additional information, you may contact 2020 Cap direct at 800-227-0038.

iSpec®

NuCraft offers a free online product configuration and specification service that saves you time and allows you to be creative while leaving the nuts and bolts to someone else. No specific software is required, nor is there any learning curve. This service applies to all NuCraft products. For additional information, call 1-877-NUCRAFT and ask for the iSpec Team or log on to www.nucraft.com/ispec.



FINISH INFORMATION

Surface Materials Palette

We crafted our materials palette using the same demanding standards that distinguish our furniture. Thoughtful design and attention to every detail elevate your possibilities.

Anchored by NuCraft veneers, unrivaled for clarity, quality, and depth of finish, our collection of surface materials comprises a sophisticated set of balanced elements that supports your design vision.

Some elements have their roots in NuCraft’s rich heritage. Others are new materials and reflect current trends and taste. Together, they ensure that you’re ready for today and positioned well for the future. Beautifully.

Custom Finishes

NuCraft specializes in expert custom finish matching. For a nominal upcharge we can provide custom finishes, and we are frequently asked to match the finishes of other furniture manufacturers. For finishes that appear unusual to match or for customers directly requesting a sample, a finish sample will be sent for approval prior to entering the order.

Custom finishes requiring colored varnishes to create a painted look can only be applied to Maple veneer and require one extra week in addition to the standard lead time. NuCraft’s standard black finish (G82) can be applied to all NuCraft standard veneers. Walnut is the standard black veneer. Other species must be specified when ordering.

Clear coat on a special veneer requires an approved sample.

Custom finishes carry a 10% upcharge per item, per finish, capped at \$1,875 List.

Custom finish upcharges are not applied to any item that is not wood. Example: casters, ganging connectors, power options..

Treatments

Note: Default veneer sheen will vary per finish and product. Default finish is bolded on pages vi-vii. If no direction is provided on incoming orders, default sheen will be selected. In addition, default veneer cut is noted in the price list. If no direction is provided on incoming orders, default cut will be selected.

Gloss: Gloss is a durable finish that tends to nicely mask normal wear and leaves wood grain visible to the eye. It achieves a medium gloss open pore appearance (40 – 50 sheen range). Finish numbers preceded by the letter “G” indicate a Gloss finish.

Matte: Like Gloss, Matte is durable, tends to nicely mask normal wear and leaves wood grain visible to the eye. It achieves a low luster, open pore appearance (10 – 20 sheen range). Finish numbers preceded by the letter “M” indicate a Matte finish.

Since each veneer type responds differently to both types of treatment, all will have a distinctive look and feel when finished. For example, a Walnut veneer with a Gloss treatment will remain much more textured than a Cherry veneer with the same treatment.

About the Wood

All NuCraft veneers are carefully selected for uniformity of color and grain. Still, wood is a natural substance and minor variations may occur due to its own uniqueness. Because of this, the furniture you receive may not be an exact match to our samples.

NuCraft takes great pride in our finish color consistency. However, wood is a natural product that will have color variation within a single piece of furniture, as well as from one piece to the next. Other factors also affect color over time, such as exposure to light (both intensity and duration). For example, lighter finishes cause more variation in colors over time.

In cases where a returning customer wants a precise match with existing furniture, we recommend sending a sample of the existing furniture finish. Please contact NuCraft Customer Service to determine an appropriate sample. This will ensure a finish match between old and new orders. This type of order is considered a control sample. There will be a 10% upcharge on an order of this type. Due to natural aging of veneers, natural finishes may vary.

Care and Maintenance of Wood Finishes

Our finish material is a crystal clear, urethane acrylic blend. This type of finish may be repaired in the field by a qualified refinisher.

NuCraft recommends using a damp cloth to clean your fine wood furniture. Always wipe with the grain of the wood. Should your wood furniture require a more thorough cleaning, we recommend using a mild cleaner such as Joy dish soap or Murphy’s oil soap, thoroughly diluted in water (one part soap to thirty parts water). Water will not damage NuCraft’s finish, but it may leave surface spots when it dries. To avoid this, dry the surface with a soft cloth after it is cleaned. Marks that cannot be removed with the cleaning methods above may be able to be removed using naphtha, a mild degreasing solvent.

Caution: while the use of polishes that contain wax, petroleum solvents or silicones may immediately enhance the “shine” of a product, it may also eventually remove the fine original finish applied in our factory. Silicone on the surface of wood may also make it very difficult to respray or refinish.

All NuCraft furniture is inspected and polished before it leaves our factory. In some instances, the packing materials may imprint on the factory polish. Cleaning and polishing the furniture once it is unpacked will normally restore the furniture to its original beauty.

In some cases, the rubber support feet used on the bottom of common office equipment (teleconferencing phones, laptops, microphones, copiers, etc.) can create unsightly marks in the surface of wood tops, due to oxidation of the lacquer finish. We suggest these machines be placed on a protective type of padding, such as felt.

Wood will fade as a result of exposure to UV light. This is particularly prevalent with light finishes. If color changes due to fading are a concern for your application, the impact can be minimized by selecting medium to dark stains for your wood surfaces. Our top coat includes a UV inhibitor which makes the finishes less prone to fading.



FINISH INFORMATION

Laminates

Selected Formica® and Nevamar® laminates are available on Training Tables, Conference Tables, Conference Room Furniture and select Occasional Tables. For standard laminate and wood pricing, refer to individual item pricing columns.

Non-Standard Laminates and Linoleums

To order a color other than those on our list (see pages vi-vii), refer to Nevamar or Formica standard grade, matte texture laminate offerings and Forbo Furniture Linoleums (excluding manufacturers' non-standard matte offering).

- For approved non-standard laminates with a hardwood edge, the upcharge is 10% of the base price per laminate color with a minimum of \$500 and capped at \$1750.
- For approved non-standard laminate with a standard ABS edge, the upcharge is \$175 per laminate color.
- For approved non-standard laminates with a non standard ABS edge, please contact customer service.

To ensure your non standard laminate is on our approved list, please contact customer service. Add one week to the lead-time for all non-standard laminate and linoleum orders. Call the Nucraft Customer Service team for quotes on premium grades and laminates. Mirror and metal laminates are not available.

Care and Maintenance of Laminate and Novawrap

Laminate and Novawrap surfaces may be cleaned with a damp cloth and ordinary soap or non-abrasive household liquid detergent. Dry the surface with a clean cloth or soft paper towel to prevent streaks from appearing.

Care and Maintenance of Metal

Metal surfaces can be wiped with a damp cloth and rubbed dry. A mild non-abrasive household liquid detergent can be used if necessary. Regular maintenance of metal components, including tightening of fasteners and light lubrication of moving parts, will extend the life of your furniture.

Satin Etched Glass

Glass color may vary slightly on multi-piece conference table tops over 180" x 60" when satin etched glass is specified due to the iron content and etching process of the glass.

Care and Maintenance of Glass

Clear or frosted glass may be cleaned with commercial glass cleaner. Be sure to use a lint-free cloth if cleaning the frosted side of the glass.

Stone and Solid Surface Material

Despite its reputation for durability, natural stone can easily be broken during handling and/or installation if proper techniques are not followed. In addition, Nucraft is not responsible for the installation of natural stone or solid surface materials on its products. Therefore, installers specifically trained in the installation of these materials must be utilized to ensure a quality installation. Nucraft shall not be liable for any damages incurred during the handling and/or installation of natural stone or solid surface materials on its products.

Care and Maintenance of Granite

Granite surfaces may be cleaned with a damp cloth and ordinary soap or non-abrasive household liquid detergent. Dry the surface with a clean cloth or soft paper towel to prevent streaks from appearing.

Care and Maintenance of Leather

Genuine leather requires very little care. Nucraft recommends that leather be dusted regularly. If a more thorough cleaning is needed, use lukewarm water and a mild, non-abrasive soap. Generate some lather and lightly rub the surface with cheesecloth. Rinse off any soap film with clean water and towel dry. The leather may dry dull. To restore the leather to a normal gloss, rub it with a clean towel. Never use furniture polish, oil, varnish or ammonia. Saddle soap may be used to prevent the leather from becoming brittle or cracked and to maintain the original supple finish.

Touch Up Finish Kits

Model #	Description	Price
KIT-M	Metal Kit	80
KIT-P	Paint Kit	80
KIT-S	Stain Kit	80

REQUIRED INFORMATION: (ORDER CANNOT BE ENTERED WITHOUT THIS INFORMATION)

- Kit model number
- Quantity of kits
- Specify finish (See pages vi-vii)

General Information:

- Touch-up kits must be ordered on a purchase order separate from Nucraft product due to Hazmat shipping



WOOD FINISHES

STANDARD

Default veneer sheen will vary per finish and were determined by a team of experts who reviewed the colorways to determine if gloss or matte best highlighted the natural characteristics of the species of wood and the color of the stain. Default finish is bolded. If no direction is provided, default sheen will be selected.

	Matte	Gloss
Ash		
Blanco	M44	G44
Char	M50	G50
Rift Cut Oak		
Carbon	M03	G03
Flat Cut Oak		
Dune	M05	G05
Portobello	M7413	G7413
Flaky Oak		
Sahara	M61	G61
Cherry		
Cognac	M21	G21
Auburn	M93	G93
Walnut		
Marron	M35	G35
Mocha	M33	G33
Zinc	M30	G30
Onyx	M82	G82
Otter	M31	G31
Maple		
Natural Maple	M60	G60
Linea		
Oak Linea	M08	G08
Walnut Linea	M27	G27
Euro Birch Linea	M09	G09
Silver Birch Linea	M10	G10
Paldao		
Thicket	M75	G75
Paldao	M76	G76
Canyon	M77	G77

METAL FINISHES

Aged Bronze	A8010
Black	A44
Blackened Nickel	ABN
Burnished	A88
Cloud	A8004
Foil	A8006
Galaxy	A8007
Polished Stainless	APS
Satin Bronze	A8011
Shadow	A8005
Storm	A8012



UPHOLSTERY FABRIC

Applies to Benches

Nucraft is pleased to have partnered with KnollTextiles, Spinneybeck, and UltraFabrics to offer a concise selection of standard upholstery fabrics pre-approved for use on our products, with prices that are figured into our graded-in system. We've carefully curated a selection of each of the textile's color lines to coordinate with our materials offering. However, all colorways are approved and available as standard. Please contact fabric manufacturer for sampling support.

Knoll Felt* | K1207 | Grade C

Ivory	1
Apple	3
Canary	5
Poppy	7
Cadet	11
Mocha	15
Pewter	17
Tar	20

Knoll Hopsack* | K1206 | Grade C

Buff	1
Stucco	2
Lime	4
Magenta	9
Red	10
Admiral	11
Putty	13
Black	16

Knoll Hourglass* | K1523 | Grade A

Gull	2
Sandbar	3
Flax	5
Beeswax	6
Sizzle	9
Tart	11
Bluebird	13
Spring	16
Bark	21
Misty	24
Alley	27

*In addition to being available on all of our bench and pedestal cushion applications, these upholstery fabrics are approved for tackzone application on Nucraft products.

Spinneybeck Volo | VO | Grade F

Lichen	902
Rust	905
Talc	939
Mauve Beige	954
Oatmeal	957
Parchment	960
Petroglyph	962
Tuscany	963
Casablanca	975
Dromedary	977
Black	BLCK

Spinneybeck Vincenza | VZ | Grade E

Salvi	2101
Ponte Furo	2102
Villabalzana	2108
Castello di Bellaguardia	2112
Scamozzi	2114
Peralolo	2115
Costozza	2116
Nocciola	2117
Appia Antica	2120
Cinque Terre	2122
Black	BLCK

UltraFabrics Brisa Original | 533 | Grade B

French Vanilla	3866
Birch	3019
White	5747
Bone	3822
Shiitake	3022
New Sand	3946
Bark	3914
Peat	3200
Canyon	3825
Coffee Bean	3023
Black Onyx	5749

GRADED-IN FABRIC PROGRAM

Top quality upholstery and fabrics from some of the biggest names in the textile industry have been graded into this price list. For a current list of graded-in manufacturers and additional information on our graded-in fabrics program, please go to www.nucraft.com. All Graded-In and COM fabrics will require pre-approval for use on Talis and Arena benches. Please contact Nucraft Customer Service for assistance with this process.

NET PRICE PER YARD	NUCRAFT GRADE
\$0 - \$25.00	A
\$25.01 - \$40.00	B
\$40.01 - \$55.00	C
\$55.01 - \$70.00	D
\$70.01 - \$85.00	E
\$85.01 - \$100.00	F
\$100.01 - \$115.00	G
\$115.01 - \$130.00	H



COM SPECIFICATION

For COM orders please include the following:

- Name of customer
- Customer's purchase order number
- Model number and quantity of piece(s) to be covered
- Specify right-way or railroad application (railroad is the default if no selection is made)
- If fabric is a stripe or pattern, specify vertical or horizontal application
- Supplier's name, material number and description

YARDAGE ESTIMATING

All yardages in the price list are based on 54" wide plain (no match) fabric. The following is a guide for fabrics that are less than 54" wide or have a pattern match.

Fabric Less Than 54" Wide

For 50" wide fabrics allow 10% additional fabric

For 48" wide fabrics allow 15% additional fabric

For 45" wide fabrics allow 20% additional fabric

For 36" wide fabrics allow 50% additional fabric

For Pattern Match Fabrics

3" to 14" repeat allow 15% additional fabric

15" to 19" repeat allow 20% additional fabric

20" to 27" repeat allow 25% additional fabric

28" to 36" repeat allow 30% additional fabric

Nucraft may add a charge for sewing, cutting and matching unusual COM or COL materials to cover additional costs. Call customer service for pricing.

It is the sole responsibility of the customer to determine that the fabric is appropriate for the application in which it will be used.

Once COM/COL is accepted, Nucraft assumes no responsibility for its overall appearance, flammability, normal durability, color fastness or any other quality after upholstered on a Nucraft product beyond our normal quality standards.

All Graded-In and COM fabrics will require pre-approval for use on Talis and Arena benches. Please contact Nucraft Customer Service for assistance with this process.

The fabric should be sent to the following address:

Nucraft Furniture Company
5151 West River Drive
Comstock Park, MI 49321
Attn: Order Processing

FIRE RESISTANCE

Nucraft will only work with textiles that meet the ACT Voluntary Performance Guidelines:

- Nucraft fabric tack panels incorporate fabrics that meet the ASTM E 84 standard US flammability test for wrapped panels.
- Nucraft upholstery fabrics for benches and cushions must meet one or more of the following flammability tests; NFPA 260, NFPA 701, or CAL 117.
- All COM fabrics must meet the required flammability standards per fabric application.
- Nucraft reserves the right to decline any fabrics that do not meet ACT standard flammability requirements.

COM LEATHER SPECIFICS

The following is a guide for specifying leather requirements. The guide is based on the following general information.

A full "domestic" hide is approximately 50-60 square feet. A specialty or calf hide is approximately 35 square feet. Of this footage there are various non-usable areas included in the hide's size. Conversion of fabric yardage to leather is approximately 1 yard = 18 square feet.

Bench Requirements

48" benches will require 1/2 domestic hide or 1 full calf hide.

60" benches will require 1 domestic hide or 2 calf hides.

72" benches will require approximately 1 full domestic hide or 3 calf hides.

The boxing around the seat, if required, will have 4-6 seams that will be placed aesthetically based on the yield and usable remains of the hides.