

TWO4SIX[®]

Planning Guide + Price List

QUICK LINKS

[PLANNING GUIDE](#)

[MEETING TABLES](#)

[MEDIA TABLES](#)

[STANDING HEIGHT
MEETING TABLES](#)

[HEIGHT ADJUSTABLE
MEETING TABLES](#)

[POWER AND DATA OPTIONS](#)

[GENERAL INFORMATION](#)

[FINISH INFORMATION](#)

[SURFACE MATERIALS](#)



TABLE OF CONTENTS

Click the shortcuts below to jump to each section.

General Information	ii-iii
Finish Information	iv-v
Surface Materials	vi-viii

Statement of Line	3
Specification Overview	4

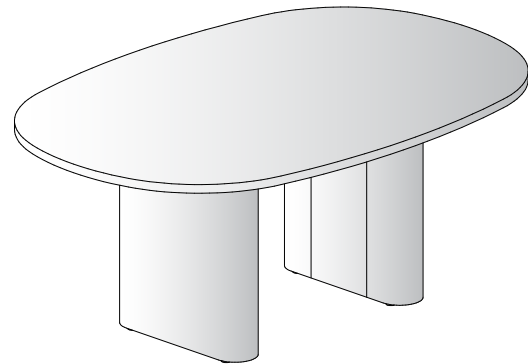
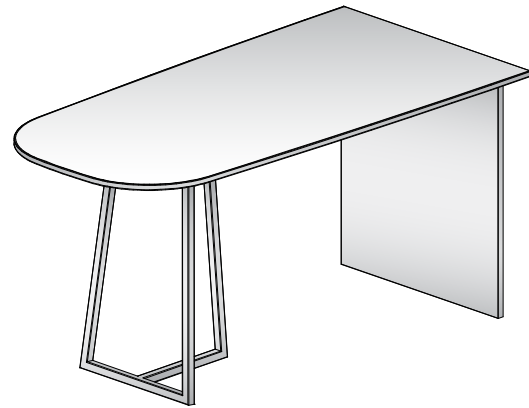
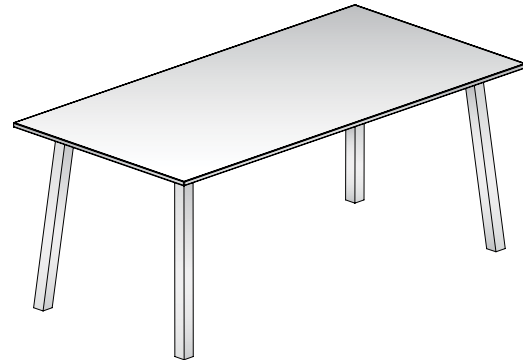
MEETING TABLES	
Round / Square / Soft Square Tops	45-51
Rectangle / Soft Rectangle Tops	52-69

MEDIA TABLES	
60" Credenza Base	70-75
72" Credenza Base	76-81
Wall-Mounted - Slab Base	82-93

STANDING HEIGHT MEETING TABLES	
Rectangle / Soft Rectangle Tops	94-111

POWER AND DATA OPTIONS	112-122
------------------------	---------

CONSOLE	123
---------	-----





STATEMENT OF LINE

MEETING TABLES

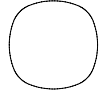
Pages 45-69



Round



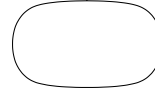
Square



Soft Square



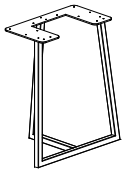
Rectangle



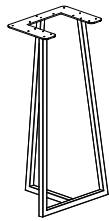
Soft Rectangle

RECTANGLE AND SOFT RECTANGLE BASES

Pages 52-69



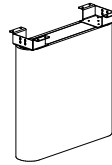
Open Frame



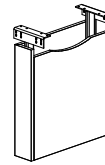
Open Frame Standing



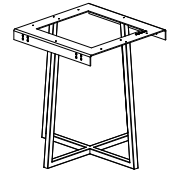
Post Leg



Racetrack Base



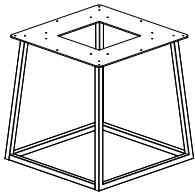
Rectangle Center Base



X Center Base

ROUND, SQUARE AND SOFT SQUARE BASES

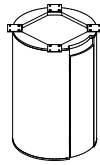
Page 45-51



Open Frame Square



Post Leg



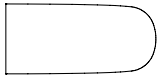
Cylinder Base



STATEMENT OF LINE

MEDIA TABLES

Pages 70-93

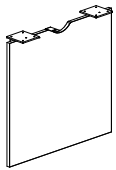


D-Shape

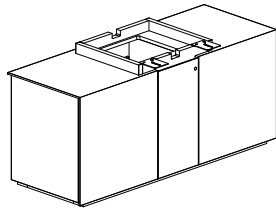
WALL-MOUNTED BASES

Pages 70-93

FLAT END OF TABLE

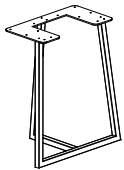


Slab

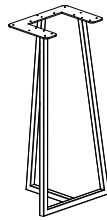


Credenza

RADIUS END OF TABLE



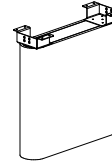
Open Frame Seated



Open Frame Standing



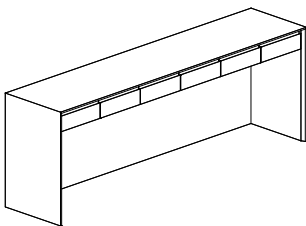
Post Leg



Racetrack Base

CONSOLE

Page 123





SPECIFICATION OVERVIEW

1. Select the Table Type

Options include Meeting Tables, Standing Height Meeting Tables, and Wall-mounted Media Tables.

2. Select the Top Surface Material

Choose between standard veneer with hardwood edge, inset laminate with hardwood edge, laminate with cutback edge, laminate with square edge, glass, solid surface or stone/quartz.

3. Select the Top Size and Shape

Two4Six tables are available in round, square, soft square, rectangle, soft rectangle, and D-shape. Sizes range from 30" - to 72"-wide and from 48" - to 240"-long.

4. Select the Base Style and Finish

Two4Six tables are available with Metal Post Legs, Open Frame, and Racetrack base styles, as well as a Height Adjustable base option. Metal Post Leg and Open Frame bases are offered with powder coated paint or polished chrome finishes. In addition, the Metal Post Leg is available with a clear anodized finish. The Racetrack base is offered in laminate, painted, or veneer. Media Tables include a Slab base (available in both painted and veneered surfaces) or a Credenza base (available in veneer only). Height adjustable Racetrack base also offered on Media Table.

5. Select the Power/AV Option (if desired)

Options for power and AV connectivity include:

- Table Top: Tech Node, Power Cap or Power Matrix (Small or Medium)
- Sub-Top: Power Rail



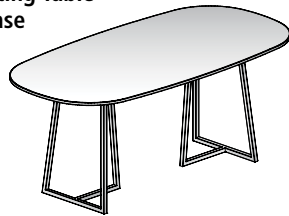
MEETING TABLES

Meeting tables are offered in round, square, soft square, rectangle and soft rectangle shapes at a seated height (29.5"). A standing height (42") option is also available for rectangle and soft rectangle tables. Meeting table base options include 2"-square Metal Post Legs, an Open Frame base (made from 1.25" square metal tube), Racetrack base, and Cylinder base (for round tables only).

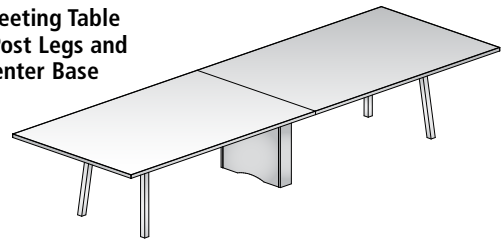
BASE MATERIAL OPTIONS						
	VENEER	PAINTED	LAMINATE	POWDER COAT	POLISHED CHROME	CLEAR ANODIZED
Racetrack	X	X	X			
2" Post Metal Leg				X	X	X
Open Frame				X	X	
TABLES 156" & LONGER						
Rectangle Center	X	X				
X Center				X	X	
MEDIA TABLES ONLY						
Wall-mounted Slab	X	X				
Credenza	X					
Rectangle Base	X	X	X			
ROUND TABLES ONLY						
Cylinder	X	X				

TOP MATERIAL OPTIONS					
	VENEER	LAMINATE (ALL EDGES)	GLASS	SOLID SURFACE	STONE
Round, Square & Soft Square	X	X	X	X	X
Rectangle & Soft Rectangle	X	X	X	X	
D-Shape	X	X	X	X	

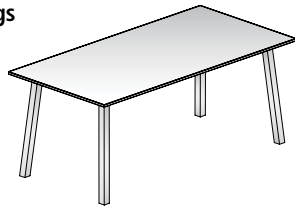
Soft Rectangle Meeting Table with Open Frame Base



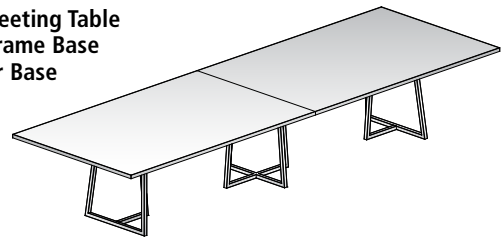
Rectangle Meeting Table with Metal Post Legs and Rectangle Center Base



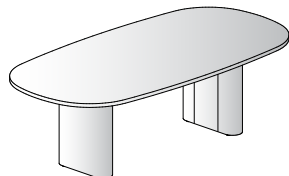
Rectangle Meeting Table with Metal Post Legs



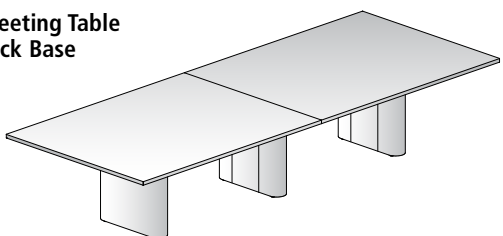
Rectangle Meeting Table with Open Frame Base and X Center Base



Soft Rectangle Meeting Table with Racetrack Base



Rectangle Meeting Table with Racetrack Base





WALL-MOUNTED MEDIA TABLES

There are two options for Media Tables: wall-mounted and freestanding. Both styles are available with a variety of base options.

Wall-mounted media tables are available in seated and standing heights and require an architectural wall on which to be mounted.

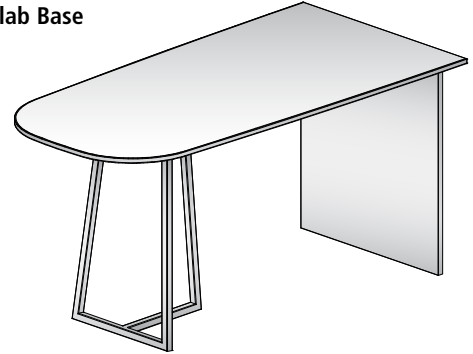
The flat end of the table offers a Slab base available in seated and standing heights. Credenza base is available in seated height and has two case sizes, 60" and 72". In addition, credenza base offers optional pullout waste/recycle bins, equipment rack available on 72", and video conferencing shelf.

On the radius end of the table, options include, 2"- square Metal Post Legs available in seated and standing height, Open Frame base available in seated and standing height or a Racetrack base available in seated and standing heights.

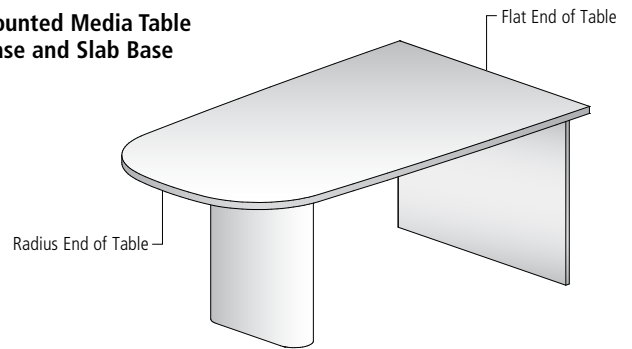
Wall mounted media tables offer optional Monitor Panel. Please see pricing section for more detail.

Please see finish matrix for finishing information on page 6.

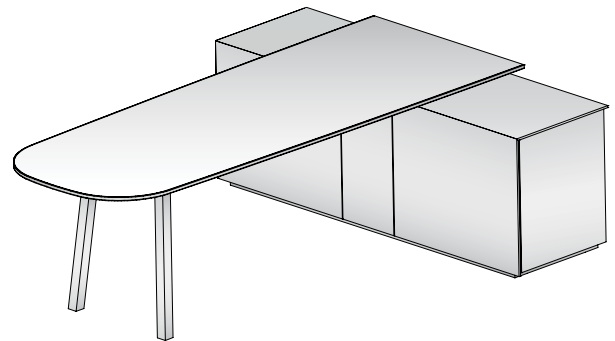
D-Shape Wall-mounted Media Table with Open Frame Base and Slab Base



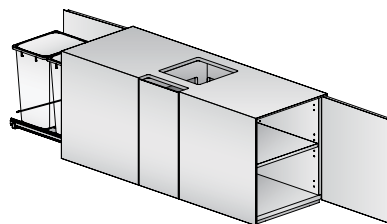
D-Shape Wall-mounted Media Table with Racetrack Base and Slab Base



D-Shape Media Table with Credenza Base



Optional Pull-Out Waste/Recycle Bins



Optional Pull-Out Equipment Rack

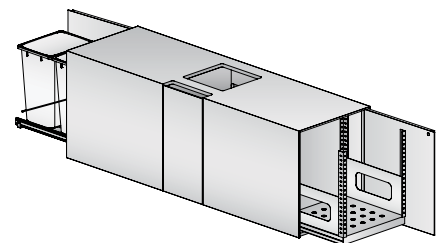


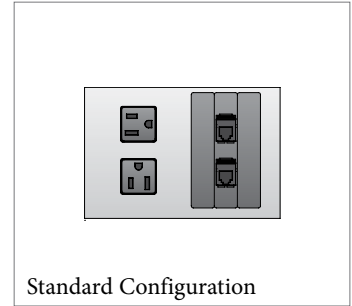
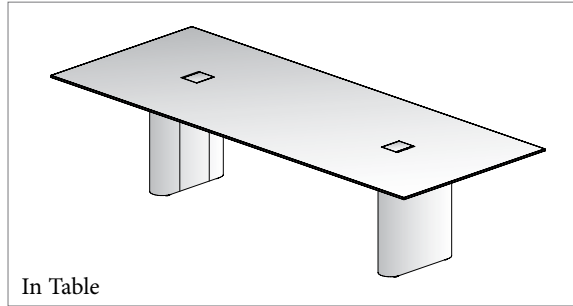
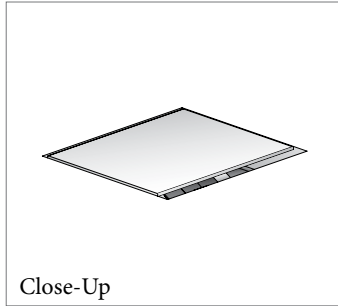


TABLE TOP POWER OPTION: POWER MATRIX

Available in a variety of sizes, styles and connectivity options, Power Matrix is Nucraft's most versatile power option. Power Matrix incorporates a broad array of scalable features and is available across multiple product lines, making it the "go to" solution for power and AV connectivity needs.

Offered in a Small and Medium size, Power Matrix can handle any power and AV connectivity need, from the simplest to the most demanding.

Small



Medium

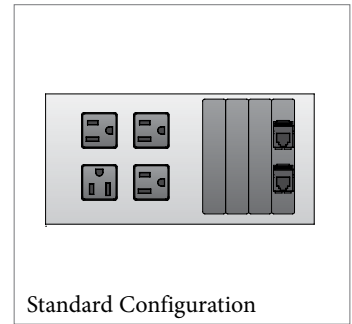
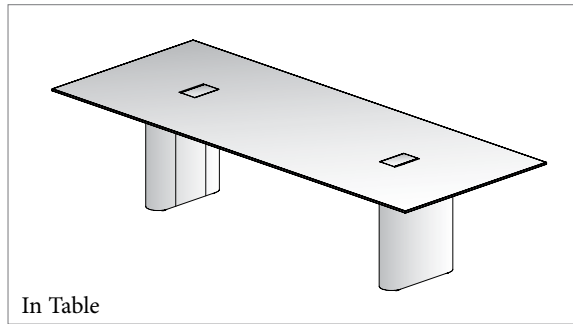
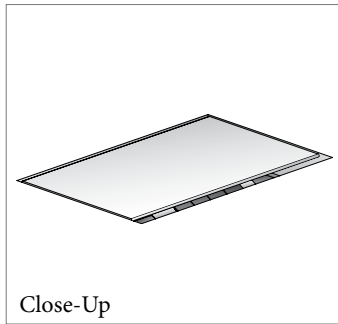




TABLE TOP POWER OPTION: POWER MATRIX

Power Matrix is filled with a broad array of high performance features and refined aesthetic elements.

POWER

Power Matrix features simplex receptacles for power connectivity, the quantity of which is pre-determined based on the size of the unit. An optional USB-A+C charger can also be specified in place of one of the simplex receptacles when desired. Corded or hardwired infeed options add flexibility.

DATA/AV FACEPLATES

Power Matrix accommodates Modular AV Inserts/Plates for unparalleled flexibility in data and AV connectivity.

DESIGN

Power Matrix units feature a clear anodized aluminum body and a bezel-free flush mount design on wood tables for an elegant appearance. Laminate, glass or stone/quartz table tops include a bezel, available in powder coat, polished chrome or clear anodized finish options.

PERFORMANCE

Friction hinges ensure smooth travel through the door's range of motion and can hold the door in any position. Hidden door stops maintain the minimalist aesthetic. Cable storage is both concealed and ample.

DOORS

Power Matrix is offered in multiple door material options, including metal, glass and grain-matched wood cut from the same table top.

FIELD-WIRED

Some local electrical codes may require field-wiring during installation. In such instances, a Field-Wired option may be specified. In this configuration, each Power Matrix unit will be supplied with a 6' flexible metal conduit with hot, ground and neutral wires.

(Medium size shown)

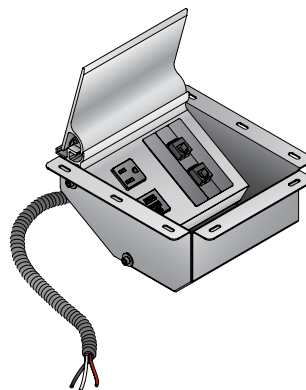
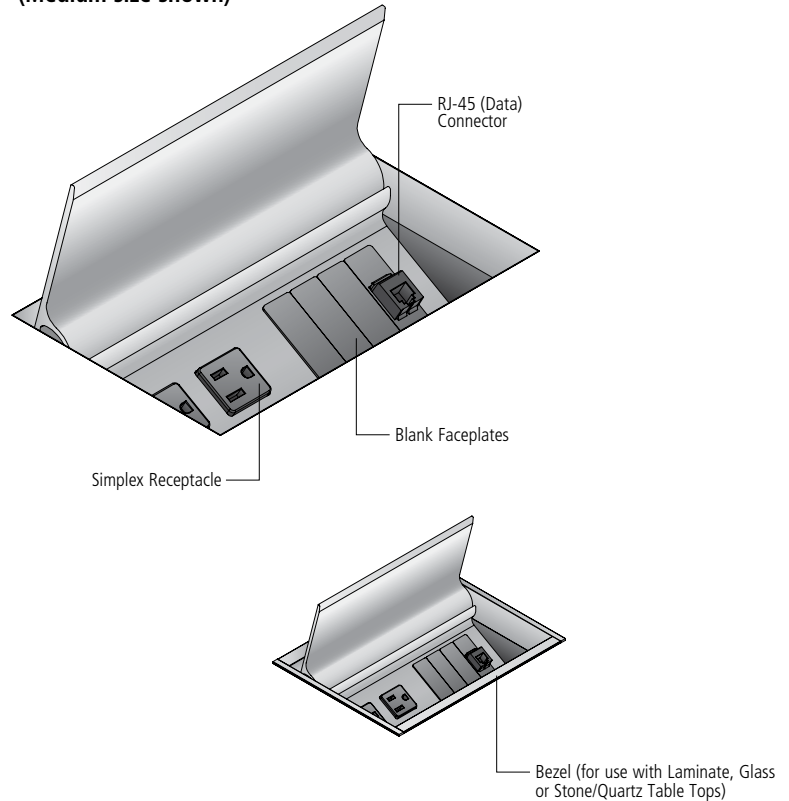




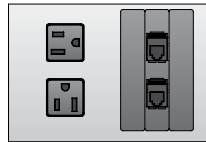
TABLE TOP POWER OPTION: POWER MATRIX

STANDARD CONFIGURATIONS

Power Matrix is available in two sizes for Two4Six, each with a pre-determined quantity of simplex outlets and AV faceplates. With each size, an optional 2 amp USB-A+C charger (1 amp per port) replaces one of the simplex outlets.

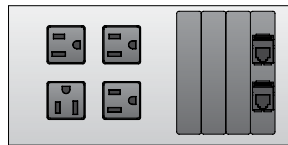
Small

- Single door design
- 5.375" x 6" cutout
- Two simplex outlets
- Three AV faceplates. Standard configuration includes two blank faceplates & one faceplate with two RJ-45 (data) connectors.



Medium

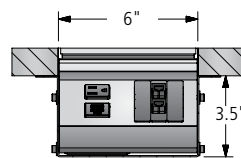
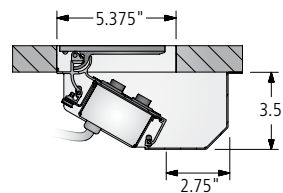
- Single door design
- 5.375" x 8.25" cutout
- Four simplex outlets
- Four AV faceplates. Standard configuration includes three blank faceplates & one faceplate with two RJ-45 (data) connectors.



DIMENSIONS

Each Power Matrix unit includes a low-profile pan beneath the work surface to conceal the unit and provide ample storage capacity for excess cables. The size of the cutout in the table top varies with each size of Power Matrix unit.

Small



Medium

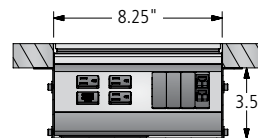
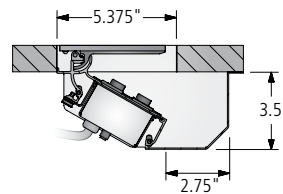




TABLE TOP POWER OPTION: POWER MATRIX

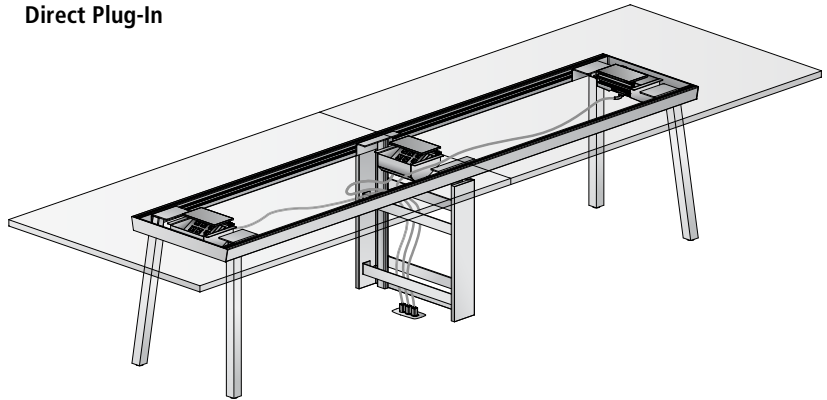
POWER PLANNING

Power Matrix is available with two options for connection with building power:

DIRECT PLUG-IN

The 15-amp power cord from each Power Matrix unit is plugged into a floor monument. The floor monument must have at least one power outlet per small or medium Power Matrix unit in the table (e.g., a table with four small or medium Power Matrix units would need four power outlets in the floor monument).

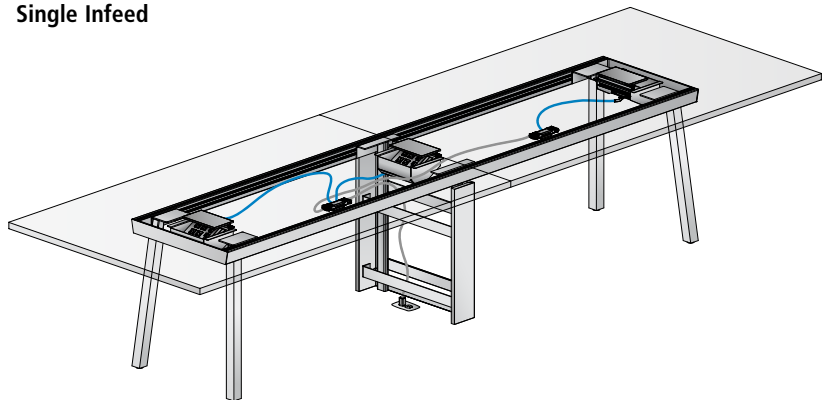
Direct Plug-In



SINGLE INFEED

Each Power Matrix unit is plugged into a two-circuit modular electrical system in the table from which a single connection is made to a floor monument. This connection can be either hardwired (to utilize both of the circuits in the modular electrical system) or corded (which requires a 20-amp power outlet in the floor monument and reduces the modular electrical system in the table to a single circuit).

Single Infeed



Two-Circuit Modular Electrical System

- 4-wire, 20-amp, 2-circuit modular electrical system
- Only present on tables specified with the Single In-Feed option
- Hardwire or corded (20-amp) in-feed options. A licensed electrician is required to complete hardwire connections to building's power source.
- Neutral (white) wires are 10 gauge, hot and ground wires are 12 gauge
- All electrical components satisfy National Electrical Code (NEC) requirements and are UL listed

Electrical Diagram — Hardwire Power Infeed Only

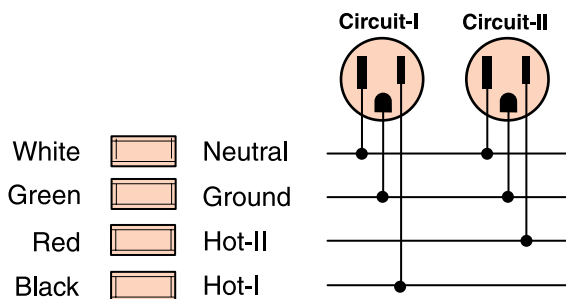




TABLE TOP POWER OPTION: POWER MATRIX

LOCATION CODES

Power Matrix is offered in a variety of locations and quantities per table size, offering a broad range of performance and pricing options.

POWER MATRIX SMALL	POWER MATRIX MEDIUM	LOCATION	QUANTITY OF UNITS TO ORDER
PS-1	PM-1	One at center	1
PS-1W	PM-1W	One at wall end (Media Table only)	1
PS-2*	PM-2*	One at each end	2
PS-3*	PM-3*	One at center and one at each end	3
PS-4*	PM-4*	Four equally spaced	4

*Not offered on Media Tables and Standing Height Tables

DOOR MATERIAL AND LOCATION AVAILABILITY BY TABLE SIZE

W = Wood Door G = Glass Door M = Metal Door

Length	Top Sections	Power Matrix Small					Power Matrix Medium				
		PS-1	PS-1W [†]	PS-2*	PS-3*	PS-4*	PM-1	PM-1W [†]	PM-2*	PM-3*	PM-4*
48	1	W/G/M	-	-	-	-	-	-	-	-	-
54	1	W/G/M	-	-	-	-	-	-	-	-	-
60	1	W/G/M	W/G/M	-	-	-	-	W/G/M	-	-	-
66	1	W/G/M	W/G/M	-	-	-	W/G/M	W/G/M	-	-	-
72	1	W/G/M	W/G/M	-	-	-	W/G/M	W/G/M	-	-	-
84	1	W/G/M	W/G/M	-	-	-	W/G/M	W/G/M	-	-	-
90	1	W/G/M	W/G/M	-	-	-	W/G/M	W/G/M	-	-	-
96	1	W/G/M	W/G/M	-	-	-	W/G/M	W/G/M	-	-	-
102	1	W/G/M	-	W/G/M	W/G/M	-	W/G/M	-	W/G/M	W/G/M	-
102	2	-	-	W/G/M	-	-	-	-	W/G/M	-	-
108	1	W/G/M	-	W/G/M	W/G/M	-	W/G/M	-	W/G/M	W/G/M	-
108	2	-	-	W/G/M	-	-	-	-	W/G/M	-	-
114	1	W/G/M	-	W/G/M	W/G/M	-	W/G/M	-	W/G/M	W/G/M	-
114	2	-	-	W/G/M	-	-	-	-	W/G/M	-	-
120	1	W/G/M	-	W/G/M	W/G/M	-	W/G/M	-	W/G/M	W/G/M	-
120	2	-	-	W/G/M	-	-	-	-	W/G/M	-	-
132	2	-	-	W/G/M	-	W/G/M	-	-	W/G/M	-	W/G/M
144	2	-	-	W/G/M	-	W/G/M	-	-	W/G/M	-	W/G/M
156	2	-	-	W/G/M	-	W/G/M	-	-	W/G/M	-	W/G/M
168	2	-	-	W/G/M	-	W/G/M	-	-	W/G/M	-	W/G/M
180	2	-	-	W/G/M	-	W/G/M	-	-	W/G/M	-	W/G/M
192	2	-	-	W/G/M	-	W/G/M	-	-	W/G/M	-	W/G/M
192	4	-	-	W/G/M	-	W/G/M	-	-	W/G/M	-	W/G/M
204	2	-	-	W/G/M	-	W/G/M	-	-	W/G/M	-	W/G/M
204	4	-	-	W/G/M	-	W/G/M	-	-	W/G/M	-	W/G/M
216	2	-	-	W/G/M	-	W/G/M	-	-	W/G/M	-	W/G/M
216	4	-	-	W/G/M	-	W/G/M	-	-	W/G/M	-	W/G/M
228	2	-	-	W/G/M	-	W/G/M	-	-	W/G/M	-	W/G/M
228	4	-	-	W/G/M	-	W/G/M	-	-	W/G/M	-	W/G/M
240	2	-	-	W/G/M	-	W/G/M	-	-	W/G/M	-	W/G/M
240	4	-	-	W/G/M	-	W/G/M	-	-	W/G/M	-	W/G/M

[†]Available on Media Tables only

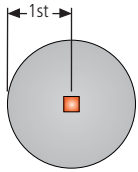
*Not offered on Media Tables or Standing Height Tables



TABLE TOP POWER OPTION: POWER MATRIX

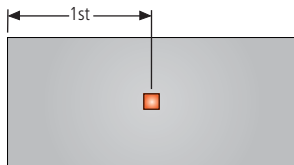
POWER MATRIX SMALL OR MEDIUM LOCATION OPTIONS

Please Note: For floor core placement, please reference base location information on pages 37-44.



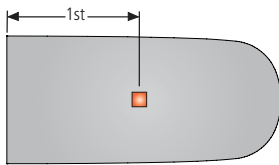
PS-1 or PM-1

PS-1 or PM-1	
Diameter	Center of Power Matrix
48	24
54	27
60	30



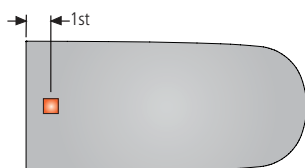
PS-1 or PM-1

PS-1 or PM-1	
Length	Center of Power Matrix
60	30
66	33
72	36
84	42
90	45
96	48
102	51
108	54
114	57
120	60



PS-1 or PM-1

PS-1 or PM-1	
Length	Center of Power Matrix
60	30
66	33
72	36
78	39
84	42
90	45
96	48



PS-1W or PM-1W*

*Available on Media Tables only

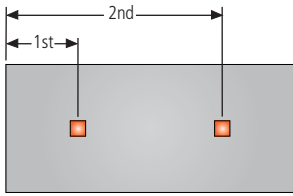
PS-1W or PM-1W*	
Length	Center of Power Matrix
60	7.5
66	7.5
72	7.5
78	7.5
84	7.5
90	7.5
96	7.5



TABLE TOP POWER OPTION: POWER MATRIX

POWER MATRIX SMALL OR MEDIUM LOCATION OPTIONS

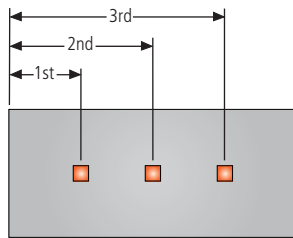
Please Note: For floor core placement, please reference base location information on pages 37-44.



PS-2 or PM-2*

*Not offered on Media Tables or Standing Height Tables

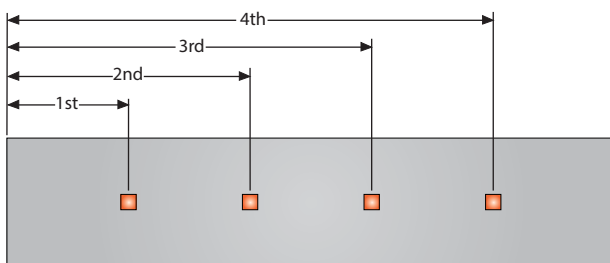
PS-2 or PM-2*		
Length	Center of 1st Power Matrix	Center of 2nd Power Matrix
102	26	76
108	26	82
114	26	88
120	26	94
132	26	106
144	26	118
156	26	130
168	26	142
180	26	154
192	26	166
204	26	178
216	26	190
228	26	202
240	26	214



PS-3 or PM-3*

*Not offered on Media Tables or Standing Height Tables

PS-3 or PM-3*			
Length	Center of 1st Power Matrix	Center of 2nd Power Matrix	Center of 3rd Power Matrix
102	26	51	76
108	26	54	82
114	26	57	88
120	26	60	94



PS-4 or PM-4*

*Not offered on Media Tables or Standing Height Tables

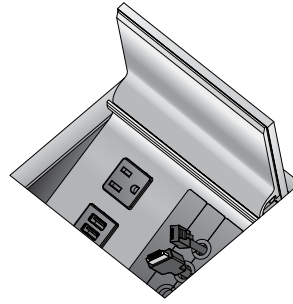
PS-4 or PM-4*				
Length	Center of 1st Power Matrix	Center of 2nd Power Matrix	Center of 3rd Power Matrix	Center of 4th Power Matrix
132	26	53	79	106
144	26	57	87	118
156	26	61	95	130
168	26	65	103	142
180	26	69	111	154
192	26	73	119	166
204	26	77	127	178
216	26	81	135	190
228	26	85	143	202
240	26	89	151	214



RETRACTORS FOR POWER MATRIX

RETRACTORS

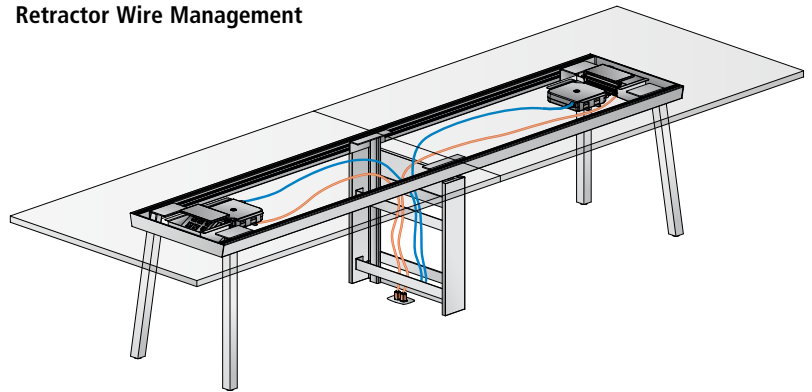
Cable retractors, for use with Power Matrix Small and Medium only, mount directly to the underside of conference room tables using the included mounting bracket. Loaded with 12' of cable that extends out 5' from the retractor. Retractors have a female input from the building infrastructure and a male connector on the output side. Not available on square, round or soft square tables.



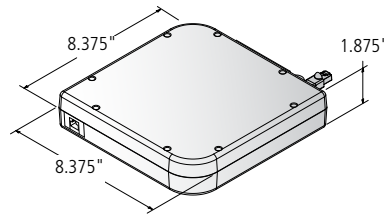
RETRACTOR AVAILABILITY ON TWO4SIX TABLES X = AVAILABLE AS STANDARD

Length	PS-1/ PM-1	PS-2/ PM-2	PS-3/ PM-3	PS-4/ PM-4
72	X			
78	X			
84	X			
90	X			
96	X			
102	X	X		
108	X	X		
114	X	X	X	
120	X	X	X	
132		X		
144		X		X
156		X		X
168		X		X
180		X		X
192		X		X
204		X		X
216		X		X
228		X		X
240		X		X

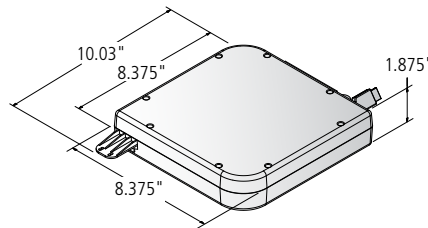
Retractor Wire Management



CAT6 Retractor



HDMI Retractor



Data USB Retractor

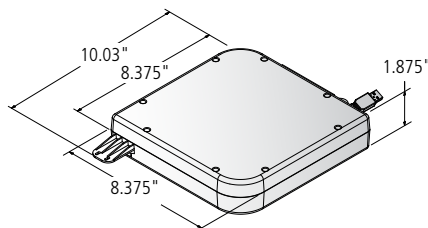




TABLE TOP POWER OPTION: POWER CAP

POWER CAP

Power Cap offers low profile yet robust power and data connectivity on the table surface. Power Cap is available in two sizes: Four Port and Two Port.

Four Port Power Cap configuration options:

- Two simplex receptacles and two USB-A+C chargers (Default Configuration)
- One simplex receptacle, one USB-A+C charger, and two blank Modular AV Inserts/Plates
- Two simplex receptacles and two blank Modular AV Inserts/Plates

Two Port Power Cap configuration options:

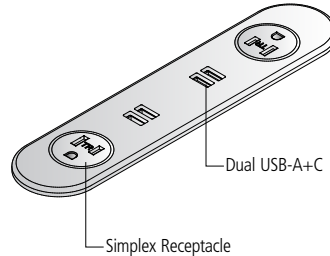
- One simplex receptacle and one USB-A+C charger (Default Configuration)
- Two simplex receptacles

Intended for high use and quick access, Power Cap's low-profile aesthetic is non-lidded for ample space for plug heads of all sizes. The Power Cap metal faceplate is available in powder coat and polished chrome finish.

DIMENSIONS

- Four Port Power Cap: 2" x 9"
- Two Port Power Cap: 2" x 5.5"
- Power Caps are 3/16" in height

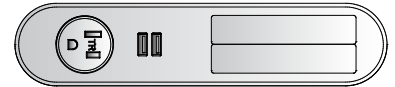
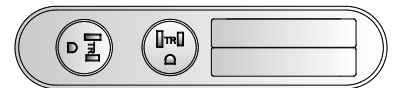
Four Port Power Cap



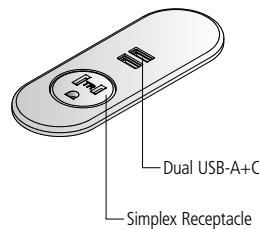
Four Port Default Configuration



Four Port Optional Configurations



Two Port Power Cap



Two Port Default Configuration



Two Port Optional Configuration

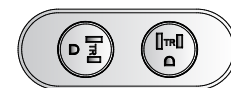




TABLE TOP POWER OPTION: POWER CAP

POWER CAP FOR ROUND, SQUARE AND SOFT SQUARE TABLES

For round, square and soft square Meeting tables, Power Cap is available in the corresponding shape.

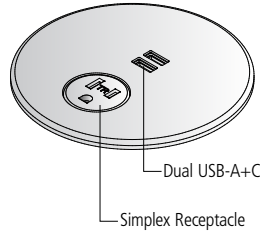
Two Port Power Cap configuration options:

- One simplex receptacle and one USB-A+C charger (Default Configuration)
- Two simplex receptacles

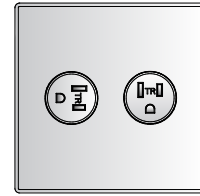
DIMENSIONS

- Two Port Round Power Cap: 5" x 5"
- Two Port Square Power Cap: 5" x 5"
- Two Port Soft Square Power Cap: 5" x 5"
- Power Caps are 3/16" in height

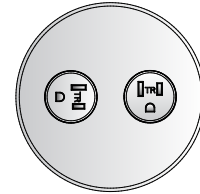
Two Port Power Cap for Round Tables



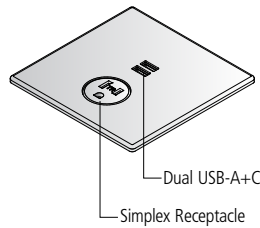
Two Port Round Default Configuration



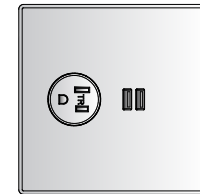
Two Port Round Optional Configuration



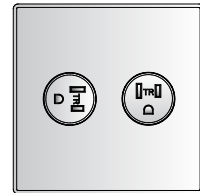
Two Port Power Cap for Square Tables



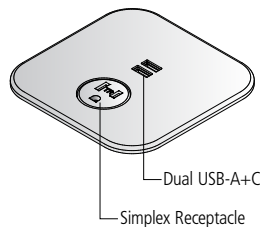
Two Port Square Default Configuration



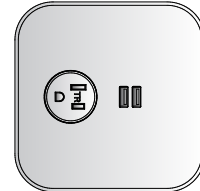
Two Port Square Optional Configuration



Two Port Power Cap for Soft Square Tables



Two Port Soft Square Default Configuration



Two Port Soft Square Optional Configuration

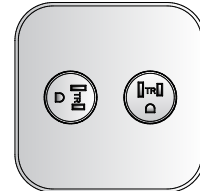




TABLE TOP POWER OPTION: POWER CAP

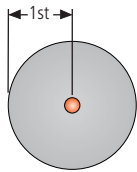
LOCATION CODES

Power Cap is offered in a variety of locations and quantities per table size, offering a broad range of performance and pricing options.

POWER CAP	DESCRIPTION	LOCATION	QUANTITY OF UNITS TO ORDER
CP4-1	Power Cap 4 Port Racetrack Shape	One at Center	1
CP4-1W	Power Cap 4 Port Racetrack Shape (Media Table)	One at End (Media Table Only)	1
CP4-2	Power Cap 4 Port Racetrack Shape	One at Each End	2
CP4-3	Power Cap 4 Port Racetrack Shape	3 Equally Spaced (starting at 96")	3
CP4-4	Power Cap 4 Port Racetrack Shape	4 Equally Spaced (starting at 132")	4
CP2-1	Power Cap 2 Port Racetrack Shape	One at Center	1
CP2-1W	Power Cap 2 Port Racetrack Shape (Media Table)	One at End (Media Table Only)	1
CP2-2	Power Cap 2 Port Racetrack Shape	One at Each End	2
CP2-3	Power Cap 2 Port Racetrack Shape	3 Equally Spaced (starting at 96")	3
CP2-4	Power Cap 2 Port Racetrack Shape	4 Equally Spaced (starting at 132")	4
CPS2-1	Power Cap 2 Port Soft Square Shape (Soft Square Tables only)	One at Center	1
CPR2-1	Power Cap 2 Port Round Shape (Round Tables Only)	One at Center	1
CPQ2-1	Power Cap 2 Port Square Shape (Square Tables Only)	One at Center	1

POWER CAP LOCATION OPTIONS

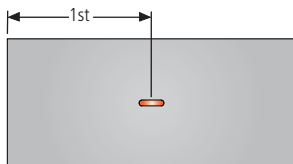
Please Note: For floor core placement, please reference base location information on pages 37-44.



CPS2-1, CPR2-1 or CPQ2-1

CPS2-1, CPR2-1 or CPQ2-1

Diameter	Center of Power Cap
48	24
54	27
60	30



CP4-1 or CP2-1

CP4-1 or CP2-1

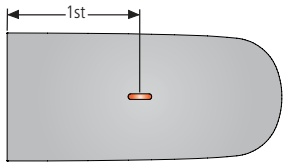
Length	Center of Power Cap
60	30
66	33
72	36
84	42
90	45
96	48
102	51
108	54
114	57
120	60



TABLE TOP POWER OPTION: POWER CAP

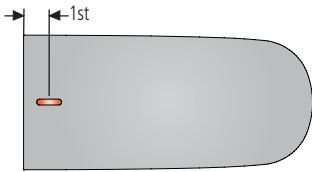
POWER CAP LOCATION OPTIONS

Please Note: For floor core placement, please reference base location information on pages 37-44.



CP4-1 or CP2-1

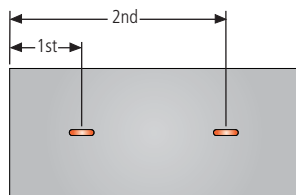
CP4-1 or CP2-1	
Length	Center of Power Cap
60	30
66	33
72	36
78	39
84	42
90	45
96	48



CP4-1W or CP2-1W*

*Available on Media Tables only

CP4-1W or CP2-1W*	
Length	Center of Power Cap
60	7.5
66	7.5
72	7.5
78	7.5
84	7.5
90	7.5
96	7.5



CP4-2 or CP2-2*

*Not offered on Media Tables or Standing Height Tables

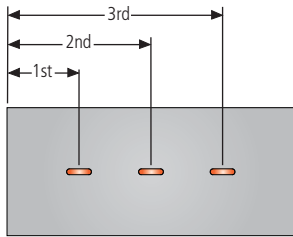
CP4-2 or CP2-2*		
Length	Center of 1st Power Cap	Center of 2nd Power Cap
102	26	76
108	26	82
114	26	88
120	26	94
132	26	106
144	26	118
156	26	130
168	26	142
180	26	154
192	26	166
204	26	178
216	26	190
228	26	202
240	26	214



TABLE TOP POWER OPTION: POWER CAP

POWER CAP LOCATION OPTIONS

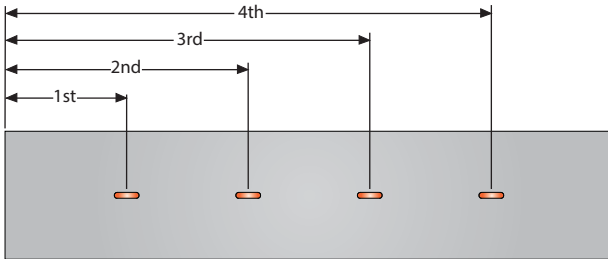
Please Note: For floor core placement, please reference base location information on pages 37-44.



CP4-3 or CP2-3*

*Not offered on Media Tables or Standing Height Tables

CP4-3 or CP2-3*			
Length	Center of 1st Power Cap	Center of 2nd Power Cap	Center of 3rd Power Cap
102	26	51	76
108	26	54	82
114	26	57	88
120	26	60	94



CP4-4 or CP2-4*

*Not offered on Media Tables or Standing Height Tables

CP4-4 or CP2-4*				
Length	Center of 1st Power Cap	Center of 2nd Power Cap	Center of 3rd Power Cap	Center of 4th Power Cap
132	26	53	79	106
144	26	57	87	118
156	26	61	95	130
168	26	65	103	142
180	26	69	111	154
192	26	73	119	166
204	26	77	127	178
216	26	81	135	190
228	26	85	143	202
240	26	89	151	214



TABLE TOP POWER OPTION: TECH NODE

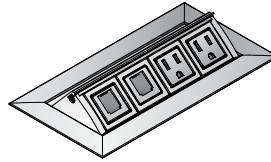
Tech Node offers convenient access to power and voice/data connections. Tech Node features include a push/push open design that conceals internal components.

Tech Node components:

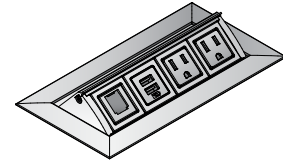
- Clear or Black Anodized Aluminum
- Fluid one touch accessibility
- Two (2) Simplexes
- Up to two voice/data ports
- 12' 15-Amp cord
- Voice/Data Adapter Kit p/n BE01421 to accept couplers & jacks
- UL Listed
- Overall dimensions - 4-7/16" x 8-5/16"
- Optional powered USB-A+C

All electrical components are UL listed.

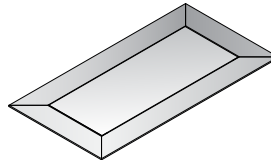
Tech Node - Cover Open



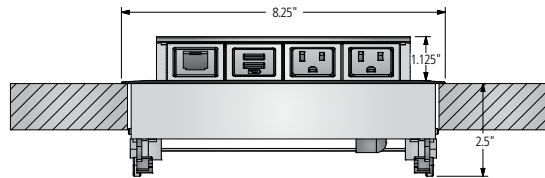
Tech Node - Cover Open with Optional USB-A+C



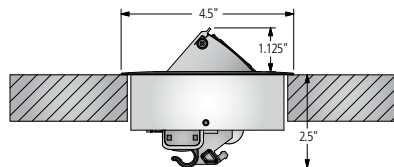
Tech Node - Cover Closed



Tech Node - Open Front View



Tech Node - Open Side View



VOICE/DATA PLANNING

Two (2) simplex voice/data cutouts accept customer supplied, field-installed snap-in connectors.

Nucraft recommends consulting an audio/visual (AV) integrator for assistance with voice/data planning.

Voice/Data Product Manufacturers

Manufacturer	Phone Number	Web Site
AMP	1-800-522-6752	www.tycoelectronics.com
Avaya	1-866-462-8292	www.avaya.com
Leviton	1-800-722-2082	www.leviton.com
Panduit	1-800-777-3300	www.panduit.com
Siemon	1-860-945-4200	www.siemon.com

LOCATION CODES

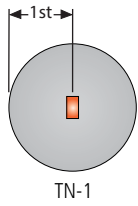
TECH NODE	LOCATION	QUANTITY OF UNITS TO ORDER
TN-1	One at center	1
TN-1W	One at wall end (Media Table only)	1
TN-2*	One at each end	2
TN-3*	One at center and one at each end	3
TN-4*	Four equally spaced	4

*TN-2, TN-3 and TN-4 not offered on Media Tables or Standing Height Tables

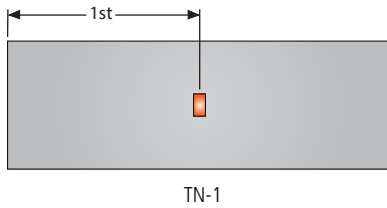


TABLE TOP POWER OPTION: TECH NODE

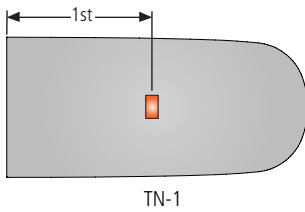
TECH NODE LOCATION OPTIONS



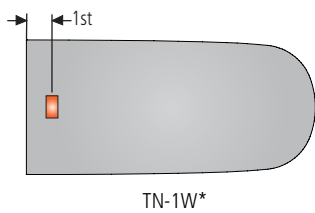
TN-1	
Length	Center of Tech Node
48	24
54	27
60	30
66	33



TN-1	
Length	Center of Tech Node
72	36
84	42
90	45
96	48
102	51
108	54
114	57
120	60



TN-1	
Length	Center of Tech Node
60	30
66	33
72	36
78	39
84	42
90	45
96	48

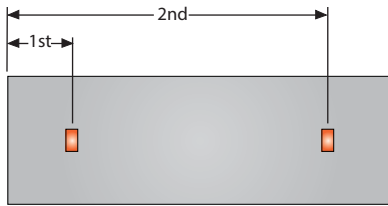


TN-1W*	
Length	Center of Tech Node
60	7.5
66	7.5
72	7.5
78	7.5
84	7.5
90	7.5
96	7.5

*Available on Media Tables only

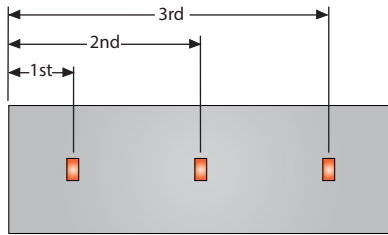
TABLE TOP POWER OPTION: TECH NODE

TECH NODE LOCATION OPTIONS



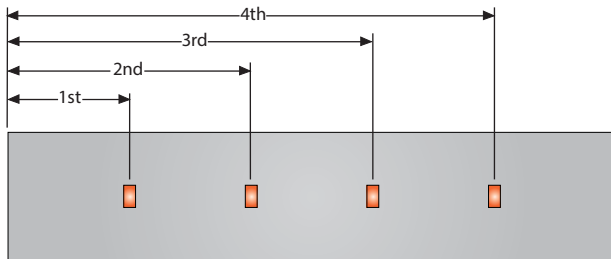
TN-2

TN-2		
Length	Center of 1st Tech Node	Center of 2nd Tech Node
102	26	76
108	26	82
114	26	88
120	26	94
132	26	106
144	26	118
156	26	130
168	26	142
180	26	154
192	26	166
204	26	178
216	26	190
228	26	202
240	26	214



TN-3

TN-3			
Length	Center of 1st Tech Node	Center of 2nd Tech Node	Center of 3rd Tech Node
102	26	51	76
108	26	54	82
114	26	57	88
120	26	60	94



TN-4

TN-4				
Length	Center of 1st Tech Node	Center of 2nd Tech Node	Center of 3rd Tech Node	Center of 4th Tech Node
132	26	53	79	106
144	26	57	87	118
156	26	61	95	130
168	26	65	103	142
180	26	69	111	154
192	26	73	119	166
204	26	77	127	178
216	26	81	135	190
228	26	85	143	202
240	26	89	151	214



TABLE TOP POWER OPTION: POWER SPEC AND USB SPEC

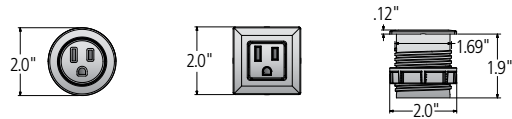
POWER SPEC AND USB SPEC

This compact unit allows for the addition of power or data to a work surface in a discreet way. Available in round or square shapes, and multiple finish options.

Power Spec

- Spill-proof power simplex
- Compact design
- 1-3/4" cutout for installation
- UL Listed

Power Spec



USB Spec

- Used to charge devices or transfer data
- Compact design
- Offered with USB-A+C
- 1-3/4" cutout for installation
- UL Listed

USB Spec

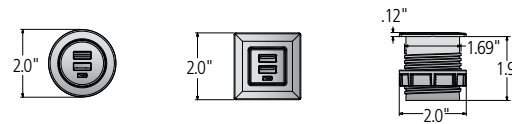




TABLE TOP POWER OPTION: POWER RAIL

POWER RAIL

This low-profile option addresses the need for power & data connectivity just below the table top. This is an ideal choice for those who desire a visually uninterrupted table top and appreciate the inherent flexibility of the Power Rail to be removed at a later date as they transition to a truly wireless environment.

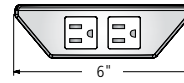
Held in place with screws, Power Rail units can be placed anywhere along the perimeter of the table. This flexible mounting design allows for additional units to be added as necessary, or to be removed when no longer needed.

Power Rails are available in three configurations:

- Two simplex receptacles (UL Listed)
- One simplex receptacle and one powered USB-A+C connector (UL Listed)
- Two single space A/V faceplates designed for use with Modular AV Inserts/Plates

When Power Rails are specified on a Two4Six table, a direct plug-in infeed or hardwired option is available. The direct plug-in infeed option has a single circuit electrical system and the hardwire option requires a two-circuit electrical system. Maximum of 12 Power Rails per table.

Front Elevation



Side Elevation

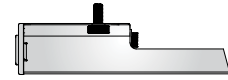
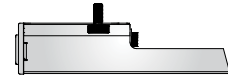
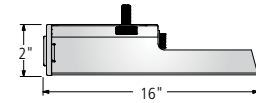


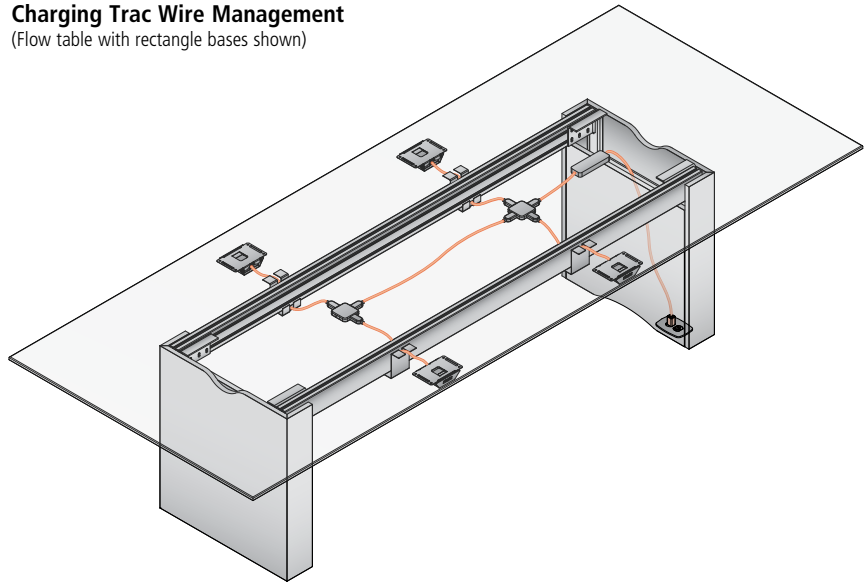


TABLE TOP POWER OPTION: CHARGING TRAC

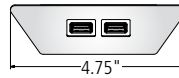
CHARGING TRAC

Charging Trac is a low voltage, under surface power system with 2 USB-A ports per unit. It's modular configuration provides a customizable solution. Offered in a 2 or 4 unit kit of parts with a plug-in infeed. USB-A compatible.

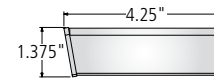
Charging Trac Wire Management (Flow table with rectangle bases shown)



Front Elevation



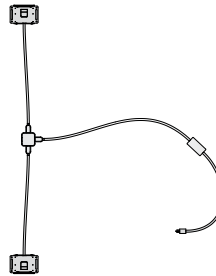
Side Elevation



Two-Unit Configuration includes:

- 2 Brackets, each bracket offers 2 USB-A ports
- 1 Puck
- 1 Plug-in infeed

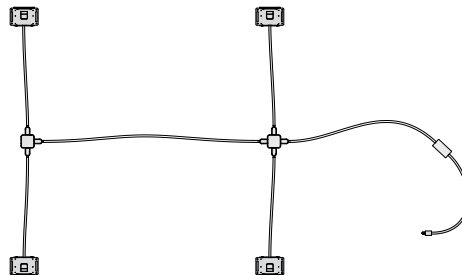
Two-Unit Configuration



Four-Unit Configuration includes:

- 4 Brackets, each bracket offers 2 USB-A ports
- 2 Pucks
- Jumpers
- 1 Plug-in infeed

Four-Unit Configuration





FREESTANDING POWER OPTION: TECH ZONE

TECH ZONE

Simple, easy to use and portable, this freestanding table top power option allows you to easily charge all of your devices.

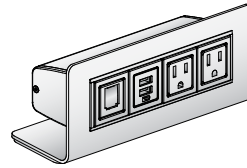
Available in two configurations with a variety of power and data connectivity options. Includes a 72"-long plug-in infeed cord.

ZONE-USB-C

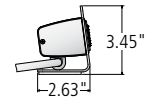
Includes two simplex receptacles, one data port and one charging USB-A+C charging port

ZONE-DATA

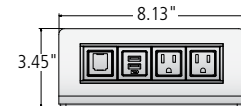
Includes two simplex receptacles and two open data ports



Tech Zone - Side View



ZONE-USB-C



ZONE-DATA





POWER PLANNING

WIRE MANAGEMENT

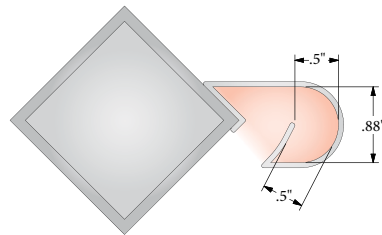
An aluminum wire management channel, included with each Two4Six table specified with the Post Leg or Open Frame base, can be adhered to the base and can accommodate power and data cables. The wire management channel comes in the same finishes as the Post Leg or Open Frame base.

For more robust needs, a 6"-square Power Pole with metal shrouds, available in any of the powder coat colors, can be specified separately and placed anywhere along the centerline of the table to manage and conceal cables as well as cover a floor monument.

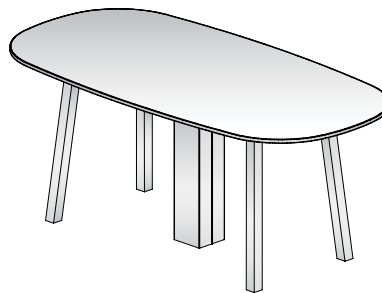
Wire Management Channel



Top View Post Leg with Wire Management Channel



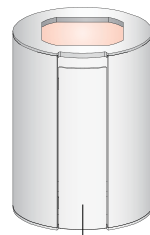
Power Pole





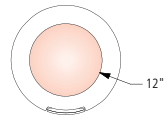
WIRE MANAGEMENT OPENINGS

Cylinder Base



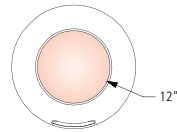
Hinged Access Door
7.5"W x 24.875"H

18"



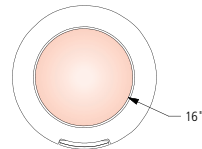
48" Diameter Tops

20"



54" Diameter Tops

24"

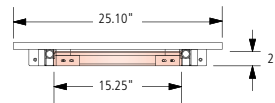


60" Diameter Tops

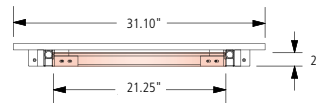
Slab Base



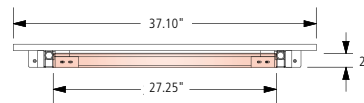
Must be anchored
to a wall, with or
without Slab Base



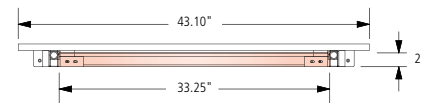
30"-Wide Tops



36"-Wide Tops



42"-Wide Tops

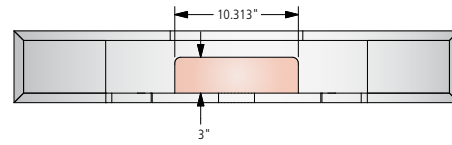
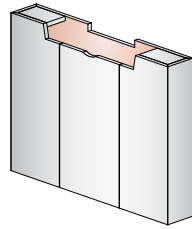


48"-Wide Tops

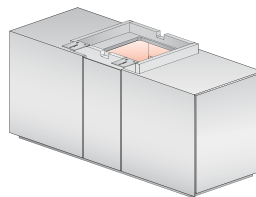


WIRE MANAGEMENT OPENINGS

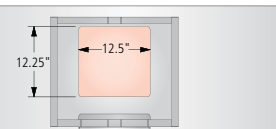
Rectangle Media Table Base



Credenza Base

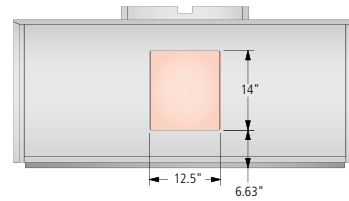


60" - Top Panel Cutout



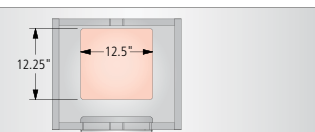
30" - 48"-Wide Tops

60" - Back Panel Cutout



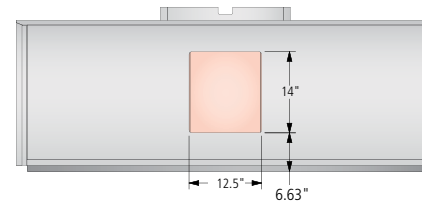
30" - 48"-Wide Tops

72" - Top Panel Cutout



30" - 48"-Wide Tops

72" - Back Panel Cutout



30" - 48"-Wide Tops

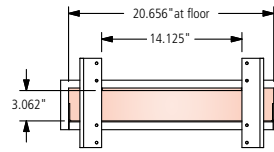
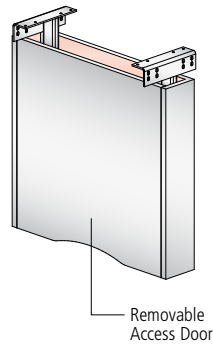


WIRE MANAGEMENT OPENINGS

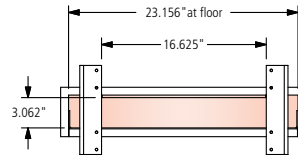
Rectangle Center Base

The Rectangle Center Base has a removable access door, whether or not power has been specified on the table.

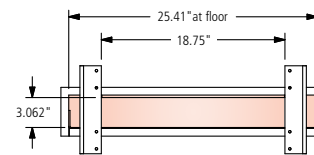
For wire management purposes, the access door features a scallop through which cables may pass. When shipped, the scallop is in the top position of the door. The access door may be rotated, however, placing the scallop in the bottom position as shown in the illustration, if needed based on the floor core location.



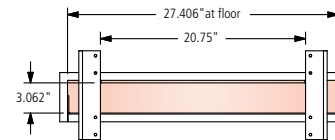
42"-Wide Tops



48"-Wide Tops



54"-Wide Tops

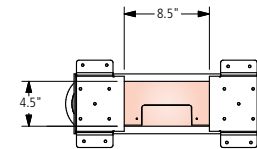
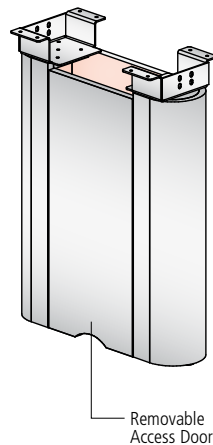


60"-Wide Tops

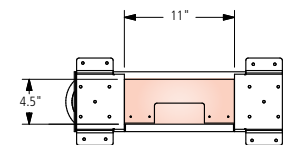
Racetrack Base

The Racetrack Base has a removable access door on the inside of the base, whether or not power has been specified on the table.

For wire management purposes, the access door features a scallop through which cables may pass. When shipped, the scallop is in the top position of the door. The access door may be rotated, however, placing the scallop in the bottom position as shown in the illustration, if needed based on the floor core location.



42"-Wide Tops



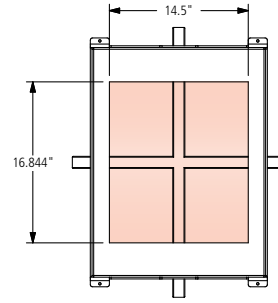
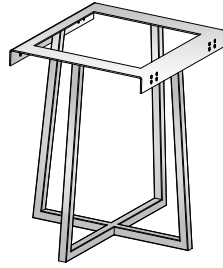
48", 54" & 60"-Wide Tops

For tables that require three bases, the center Racetrack base also has a removable access door, but on only one side of the base.

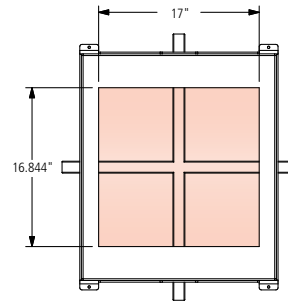


WIRE MANAGEMENT OPENINGS

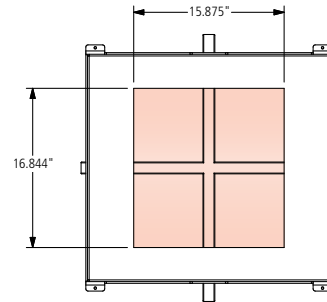
X Center Base



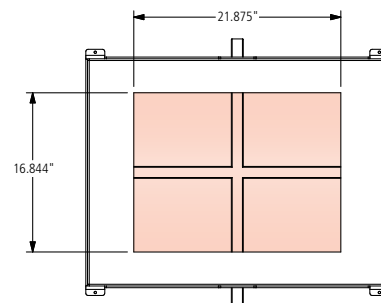
42"-Wide Tops



48"-Wide Tops



54"-Wide Tops

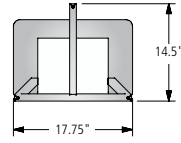
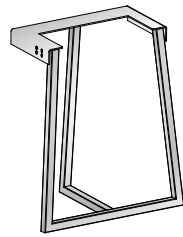


60"-Wide Tops

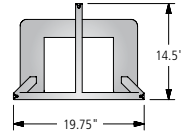


BASE DIMENSIONS

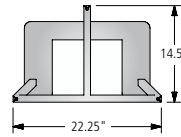
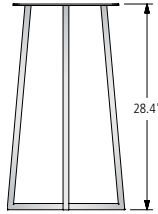
Open Frame Seated Height Base



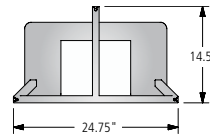
30"-Wide Tops



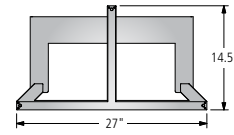
36"-Wide Tops



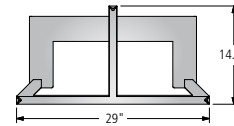
42"-Wide Tops



48"-Wide Tops

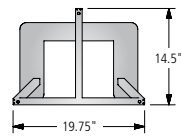
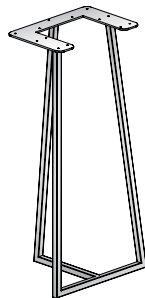


54"-Wide Tops

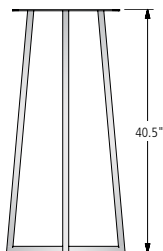


60"-Wide Tops

Open Frame Standing Height Base (for use with Slab Base)



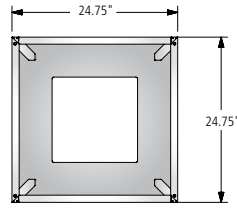
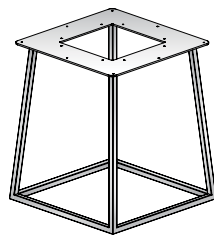
30" - 48"-Wide Tops



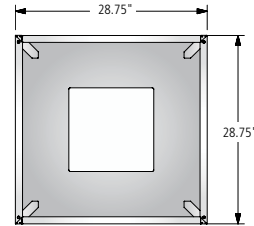
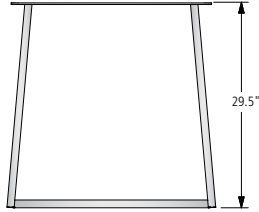


BASE DIMENSIONS

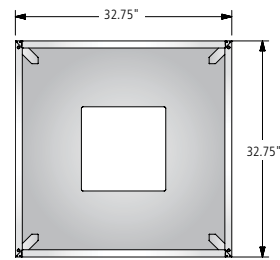
Open Frame Square Base



48"-Wide Tops



54"-Wide Tops

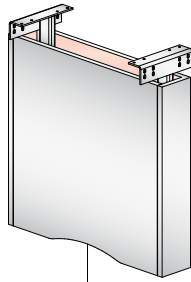


60"-Wide Tops

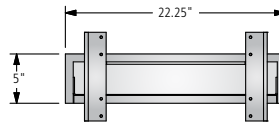


BASE DIMENSIONS

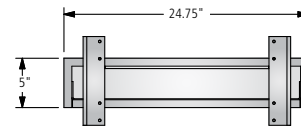
Rectangle Center Base



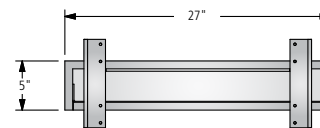
Rectangle Center Base ships with the scallop in the top position. The access door may be rotated, however, placing the scallop in the the bottom position as shown for wire management.



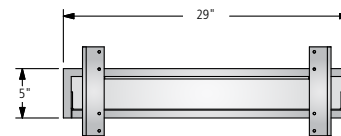
42"-Wide Tops



48"-Wide Tops

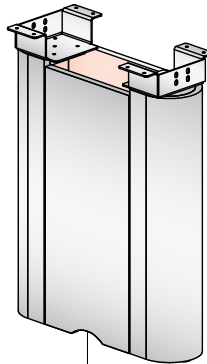


54"-Wide Tops

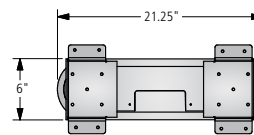


60"-Wide Tops

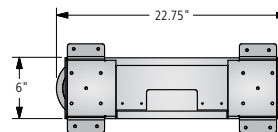
Racetrack Base



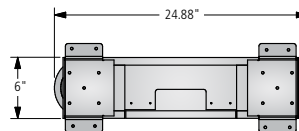
Racetrack Base ships with the scallop in the top position. The access door may be rotated, however, placing the scallop in the the bottom position as shown for wire management.



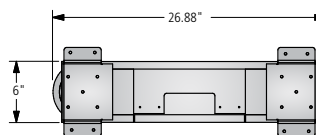
42"-Wide Tops



48"-Wide Tops



54"-Wide Tops

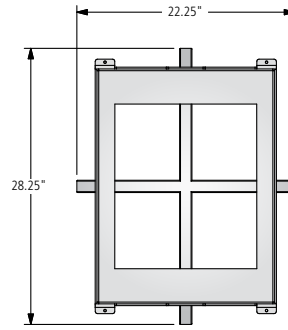
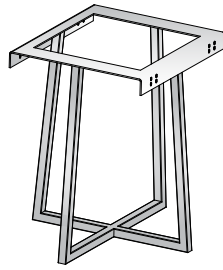


60"-Wide Tops

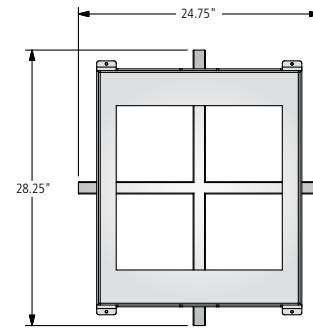


BASE DIMENSIONS

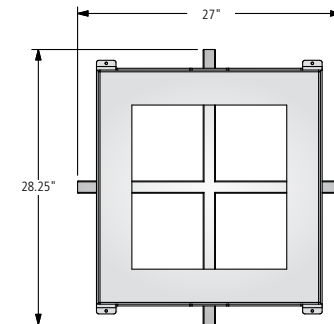
X Center Base



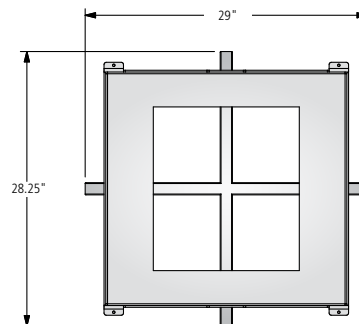
42"-Wide Tops



48"-Wide Tops



54"-Wide Tops



60"-Wide Tops



BASE LOCATIONS

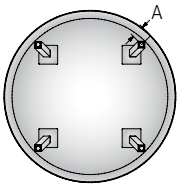
ROUND, SQUARE AND SOFT SQUARE TABLES WITH POST LEGS

Two4Six tables in Round, Square, and Rectangle shapes include two leg mounting locations for Post Legs; the standard location (where the bottom of each leg is close to the edge of the table) and an inset position (where the leg is inset slightly for an alternate aesthetic). The inset position on the Rectangle table is ideal if the meeting table is going to be used as a desk. The charts on the following pages indicate the positioning of the Post Legs (in this inset position) as well as the Open Frame bases on Two4Six Meeting tables to assist with floor monument locations.

Inset Leg Dimensions

(as measured from the edge of the table top to the center of the glide)

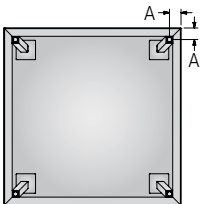
Round



Note: This is the only Post Leg position.

Table Size	Base	A
48"	Post Leg	3.6
54"	Post Leg	3.6
60"	Post Leg	3.6

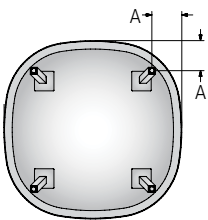
Square



Note: This is the only Post Leg position.

Table Size	Base	A
48"	Post Leg	3.2
54"	Post Leg	3.2
60"	Post Leg	3.2

Soft Square



Note: This is the only Post Leg position.

Table Size	Base	A
48"	Post Leg	8.1
54"	Post Leg	8.8
60"	Post Leg	9.5



BASE LOCATIONS

ROUND, SQUARE AND SOFT SQUARE TABLES WITH OPEN FRAME SQUARE BASE

Open Frame Square Base Dimensions

(as measured from the edge of the table top to the center of the glide)

Round

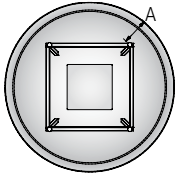


Table Size	Base	A
48"	Open Frame	7.6
54"	Open Frame	7.7
60"	Open Frame	7.9

Square

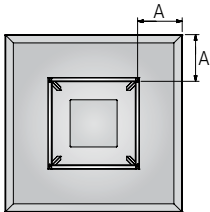


Table Size	Base	A
48"	Open Frame	12.5
54"	Open Frame	13.5
60"	Open Frame	14.5

Soft Square

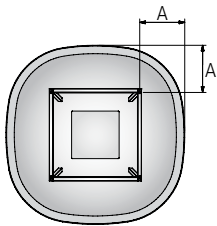


Table Size	Base	A
48"	Open Frame	12.5
54"	Open Frame	13.5
60"	Open Frame	14.5

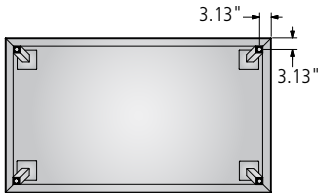


BASE LOCATIONS

RECTANGLE TABLE WITH POST LEGS

Rectangle-shaped tables have two mounting location options for Metal Post Legs: inset, where the legs are mounted inset of the edge of the table, and outset, where the legs are mounted at the corners of the table. The outset option is available on tables from 60" to 96"-long.

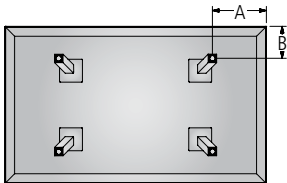
Outset Leg Dimensions



Note: Outset Leg option available on tables between 60" to 96" L.

Inset Leg Dimensions

Sizes 60" to 96" L



Sizes 102" to 144" L



Table Size	Base	A (End)	B (Side)
60 x 30	Post Leg	12.4	4.4
66 x 30	Post Leg	12.4	4.4
72 x 30	Post Leg	12.4	4.4
78 x 30	Post Leg	15.9	4.4
84 x 30	Post Leg	15.9	4.4
90 x 30	Post Leg	15.9	4.4
96 x 30	Post Leg	15.9	4.4
60 x 36	Post Leg	12.4	7.4
66 x 36	Post Leg	12.4	7.4
72 x 36	Post Leg	12.4	7.4
78 x 36	Post Leg	15.9	7.4
84 x 36	Post Leg	15.9	7.4
90 x 36	Post Leg	15.9	7.4
96 x 36	Post Leg	15.9	7.4
60 x 42	Post Leg	12.4	10.4
66 x 42	Post Leg	12.4	10.4
72 x 42	Post Leg	12.4	10.4
78 x 42	Post Leg	15.9	10.4
84 x 42	Post Leg	15.9	10.4
90 x 42	Post Leg	15.9	10.4
96 x 42	Post Leg	15.9	10.4
60 x 48	Post Leg	12.4	12.1
66 x 48	Post Leg	12.4	12.1
72 x 48	Post Leg	12.4	12.1
78 x 48	Post Leg	15.9	12.1
84 x 48	Post Leg	15.9	12.1
90 x 48	Post Leg	15.9	12.1
96 x 48	Post Leg	15.9	12.1
102 x 42	Post Leg	20.5	10.4
102 x 48	Post Leg	20.5	12.2
108 x 42	Post Leg	20.5	10.4
108 x 48	Post Leg	20.5	12.2
108 x 54	Post Leg	20.5	14.1
114 x 42	Post Leg	20.5	10.4
114 x 48	Post Leg	20.5	12.2
114 x 54	Post Leg	20.5	14.1
120 x 42	Post Leg	20.5	10.4
120 x 48	Post Leg	20.5	12.2
120 x 54	Post Leg	20.5	14.1
132 x 42	Post Leg	20.5	10.4
132 x 48	Post Leg	20.5	12.2
132 x 54	Post Leg	20.5	14.1
144 x 48	Post Leg	20.5	12.2
144 x 54	Post Leg	20.5	14.1
144 x 60	Post Leg	20.5	16.1



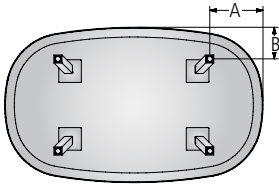
BASE LOCATIONS

SOFT RECTANGLE TABLE WITH POST LEGS

Inset Leg Dimensions

Note: This is the only Post Leg position on Soft Rectangle tables.

Sizes 60" to 96"L



Sizes 102" to 144"L

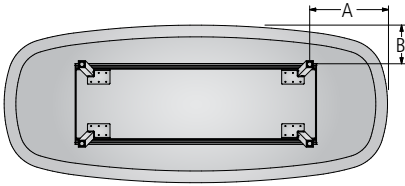


Table Size	Base	A (End)	B (Side)
60 x 30	Post Leg	12.2	4.4
66 x 30	Post Leg	12.2	4.4
72 x 30	Post Leg	12.2	4.4
78 x 30	Post Leg	15.7	4.4
84 x 30	Post Leg	15.7	4.4
90 x 30	Post Leg	15.7	4.4
96 x 30	Post Leg	15.7	4.4
60 x 36	Post Leg	12.2	7.4
66 x 36	Post Leg	12.2	7.4
72 x 36	Post Leg	12.2	7.4
78 x 36	Post Leg	15.7	7.4
84 x 36	Post Leg	15.7	7.4
90 x 36	Post Leg	15.7	7.4
96 x 36	Post Leg	15.7	7.4
60 x 42	Post Leg	12.2	10.4
66 x 42	Post Leg	12.2	10.4
72 x 42	Post Leg	12.2	10.4
78 x 42	Post Leg	15.7	10.4
84 x 42	Post Leg	15.7	10.4
90 x 42	Post Leg	15.7	10.4
96 x 42	Post Leg	15.7	10.4
60 x 48	Post Leg	12.2	12.1
66 x 48	Post Leg	12.2	12.1
72 x 48	Post Leg	12.2	12.1
78 x 48	Post Leg	15.7	12.1
84 x 48	Post Leg	15.7	12.1
90 x 48	Post Leg	15.7	12.1
96 x 48	Post Leg	15.7	12.1
102 x 42	Post Leg	20.5	10.4
102 x 48	Post Leg	20.5	12.2
108 x 42	Post Leg	20.5	10.4
108 x 48	Post Leg	20.5	12.2
108 x 54	Post Leg	20.5	14.1
114 x 42	Post Leg	20.5	10.4
114 x 48	Post Leg	20.5	12.2
114 x 54	Post Leg	20.5	14.1
120 x 42	Post Leg	20.5	10.4
120 x 48	Post Leg	20.5	12.2
120 x 54	Post Leg	20.5	14.1
132 x 42	Post Leg	20.5	10.4
132 x 48	Post Leg	20.5	12.2
132 x 54	Post Leg	20.5	14.1
144 x 48	Post Leg	20.5	12.2
144 x 54	Post Leg	20.5	14.1
144 x 60	Post Leg	20.5	16.1



BASE LOCATIONS

RECTANGLE AND SOFT RECTANGLE TABLES WITH POST LEGS AND RECTANGLE CENTER BASE

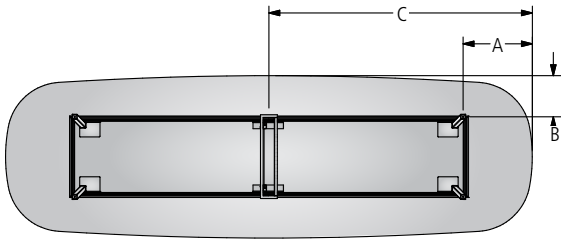
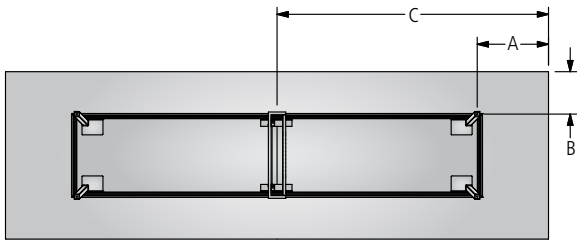


Table Size	Base	A (End)	B (Side)	C (Center)
156 x 48	Post Leg	20.5	12.2	78
156 x 54	Post Leg	20.5	14.1	78
156 x 60	Post Leg	20.5	16.1	78
168 x 54	Post Leg	20.5	14.1	84
168 x 60	Post Leg	20.5	16.1	84
180 x 54	Post Leg	20.5	14.1	90
180 x 60	Post Leg	20.5	16.1	90
192 x 54	Post Leg	20.5	14.1	96
192 x 60	Post Leg	20.5	16.1	96
204 x 54	Post Leg	20.5	14.1	102
204 x 60	Post Leg	20.5	16.1	102
216 x 54	Post Leg	20.5	14.1	108
216 x 60	Post Leg	20.5	16.1	108
228 x 54	Post Leg	20.5	14.1	114
228 x 60	Post Leg	20.5	16.1	114
240 x 54	Post Leg	20.5	14.1	120
240 x 60	Post Leg	20.5	16.1	120



BASE LOCATIONS

RECTANGLE AND SOFT RECTANGLE TABLES WITH OPEN FRAME

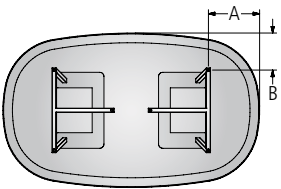
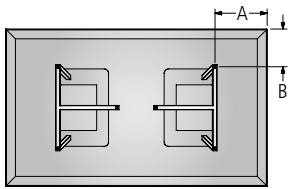


Table Size	Base	A (End)	B (Side)
60 x 30	Open Frame	12	6.8
66 x 30	Open Frame	12	6.8
72 x 30	Open Frame	12	6.8
78 x 30	Open Frame	15.5	6.8
84 x 30	Open Frame	15.5	6.8
90 x 30	Open Frame	15.5	6.8
96 x 30	Open Frame	15.5	6.8
60 x 36	Open Frame	12	8.6
66 x 36	Open Frame	12	8.6
72 x 36	Open Frame	12	8.6
78 x 36	Open Frame	15.5	8.6
84 x 36	Open Frame	15.5	8.6
90 x 36	Open Frame	15.5	8.6
96 x 36	Open Frame	15.5	8.6
60 x 42	Open Frame	12	10.4
66 x 42	Open Frame	12	10.4
72 x 42	Open Frame	12	10.4
78 x 42	Open Frame	15.5	10.4
84 x 42	Open Frame	15.5	10.4
90 x 42	Open Frame	15.5	10.4
96 x 42	Open Frame	15.5	10.4
60 x 48	Open Frame	12	12.1
66 x 48	Open Frame	12	12.1
72 x 48	Open Frame	12	12.1
78 x 48	Open Frame	15.5	12.1
84 x 48	Open Frame	15.5	12.1
90 x 48	Open Frame	15.5	12.1
96 x 48	Open Frame	15.5	12.1
102 x 42	Open Frame	20.5	10.4
102 x 48	Open Frame	20.5	12.1
108 x 42	Open Frame	20.5	10.4
108 x 48	Open Frame	20.5	12.1
108 x 54	Open Frame	20.5	14.1
114 x 42	Open Frame	20.5	10.4
114 x 48	Open Frame	20.5	12.1
114 x 54	Open Frame	20.5	14
120 x 42	Open Frame	20.5	10.4
120 x 48	Open Frame	20.5	12.1
120 x 54	Open Frame	20.5	14
132 x 42	Open Frame	20.5	10.4
132 x 48	Open Frame	20.5	12.1
132 x 54	Open Frame	20.5	14
144 x 48	Open Frame	20.5	12.1
144 x 54	Open Frame	20.5	14
144 x 60	Open Frame	20.5	16



BASE LOCATIONS

RECTANGLE AND SOFT RECTANGLE TABLES WITH OPEN FRAME AND X CENTER BASE

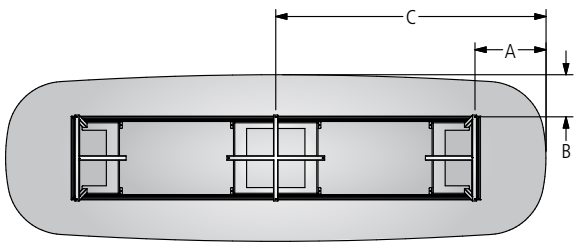
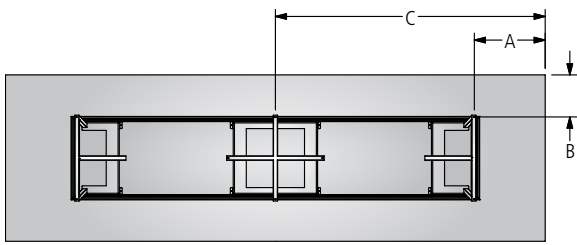


Table Size	Base	A (End)	B (Side)	C (Center)
156 x 48	Open Frame	20.5	12.1	78
156 x 54	Open Frame	20.5	14	78
156 x 60	Open Frame	20.5	16	78
168 x 54	Open Frame	20.5	14	84
168 x 60	Open Frame	20.5	16	84
180 x 54	Open Frame	20.5	14	90
180 x 60	Open Frame	20.5	16	90
192 x 54	Open Frame	20.5	14	96
192 x 60	Open Frame	20.5	16	96
204 x 54	Open Frame	20.5	14	102
204 x 60	Open Frame	20.5	16	102
216 x 54	Open Frame	20.5	14	108
216 x 60	Open Frame	20.5	16	108
228 x 54	Open Frame	20.5	14	114
228 x 60	Open Frame	20.5	16	114
240 x 54	Open Frame	20.5	14	120
240 x 60	Open Frame	20.5	16	120



BASE LOCATIONS

RECTANGLE AND SOFT RECTANGLE TABLES WITH RACETRACK BASE

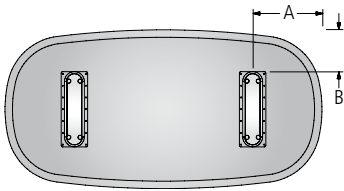
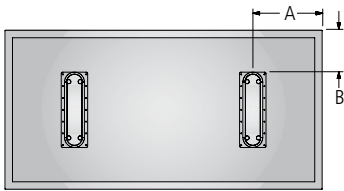


Table Size	Base	A (End)	B (Side)
72 x 42	Racetrack	21	10.38
78 x 42	Racetrack	21	10.38
84 x 42	Racetrack	21	10.38
90 x 42	Racetrack	21	10.38
96 x 42	Racetrack	21	10.38
72 x 48	Racetrack	21	12.63
78 x 48	Racetrack	21	12.63
84 x 48	Racetrack	21	12.63
90 x 48	Racetrack	21	12.63
96 x 48	Racetrack	21	12.63
102 x 42	Racetrack	26	10.38
102 x 48	Racetrack	26	12.63
108 x 42	Racetrack	26	10.38
108 x 48	Racetrack	26	12.63
108 x 54	Racetrack	26	14.56
114 x 42	Racetrack	26	10.38
114 x 48	Racetrack	26	12.63
114 x 54	Racetrack	26	14.56
120 x 42	Racetrack	26	10.38
120 x 48	Racetrack	26	12.63
120 x 54	Racetrack	26	14.56
132 x 42	Racetrack	26	10.38
132 x 48	Racetrack	26	12.63
132 x 54	Racetrack	26	14.56
144 x 48	Racetrack	26	12.63
144 x 54	Racetrack	26	14.56
144 x 60	Racetrack	26	16.56

RECTANGLE AND SOFT RECTANGLE TABLES WITH RACETRACK BASE

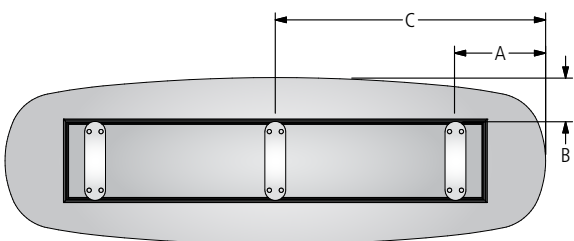
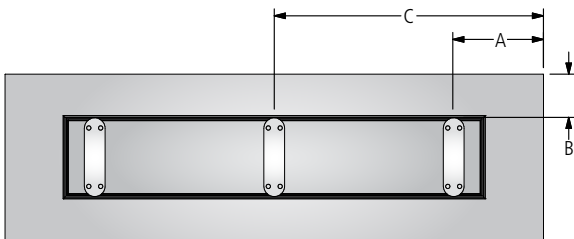


Table Size	Base	A (End)	B (Side)	C (Center)
156 x 48	Racetrack	26	12.63	78
156 x 54	Racetrack	26	14.56	78
156 x 60	Racetrack	26	16.56	78
168 x 54	Racetrack	26	14.56	84
168 x 60	Racetrack	26	16.56	84
180 x 54	Racetrack	26	14.56	90
180 x 60	Racetrack	26	16.56	90
192 x 54	Racetrack	26	14.56	96
192 x 60	Racetrack	26	16.56	96
204 x 54	Racetrack	26	14.56	102
204 x 60	Racetrack	26	16.56	102
216 x 54	Racetrack	26	14.56	108
216 x 60	Racetrack	26	16.56	108
228 x 54	Racetrack	26	14.56	114
228 x 60	Racetrack	26	16.56	114
240 x 54	Racetrack	26	14.56	120
240 x 60	Racetrack	26	16.56	120



VENEER TOP WITH HARDWOOD EDGE



ROUND TOP



SQUARE TOP



SOFT SQUARE TOP

BASE KEY

- PC Painted Cylinder
- VY Veneer Cylinder
- OS Open Frame Square
- ML Post Metal Leg

ROUND TABLES

MODEL #	DIAMETER	SEATING CAPACITY	-PC	-VY	-OS	-ML
TFR-48-V	48	4	4,872	5,089	3,582	3,245
TFR-54-V	54	6	5,933	6,172	4,469	3,975
TFR-60-V	60	6	6,946	7,200	5,350	4,681

SQUARE TABLES

MODEL #	LENGTH	WIDTH	SEATING CAPACITY	-OS	-ML
TFS-4848-V	48	48	4	3,582	3,245
TFS-5454-V	54	54	6	4,469	3,975
TFS-6060-V	60	60	6	5,350	4,681

SOFT SQUARE TABLES

MODEL #	LENGTH	WIDTH	SEATING CAPACITY	-OS	-ML
TFQ-4848-V	48	48	4	3,582	3,245
TFQ-5454-V	54	54	6	4,469	3,975
TFQ-6060-V	60	60	6	5,350	4,681

OPTIONS

Power & Data Options

CODE

PRICE

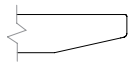
NOTES

See pages 112-122

Polished Chrome Finish Options:

- Polished Chrome Open Frame Square Add **-PCOS** \$1,186
- Polished Chrome Post Metal Legs Add **-PCML-TWB** \$1,284

EDGE PROFILE



Two4Six Cutback Edge

GENERAL INFORMATION

- Tops are 1-1/8"-thick with 3/16"-thick hardwood edge band
- Seating capacity based on 27" per person
- Overall table height 29.5"
- Standard with quarter cut veneer
- One section of wire management channel provided per table with Post Metal Leg and Open Frame Square Base

REQUIRED INFORMATION (ORDER CANNOT BE ENTERED WITHOUT THIS INFORMATION)

See appendix pages vi-viii for surface material options.

- Choose Veneer Finish
- Choose Paint Finish, if -PC base is specified
- Choose Metal Finish only if -OS or -ML bases specified (Clear Anodized (-CA) is an option on the Post Metal Leg only)



INSET LAMINATE TOP WITH HARDWOOD EDGE



ROUND TOP



SQUARE TOP



SOFT SQUARE TOP

BASE KEY

PC	Painted Cylinder
VY	Veneer Cylinder
OS	Open Frame Square
ML	Post Metal Leg

ROUND TABLES

MODEL #	DIAMETER	SEATING CAPACITY	-PC	-VY	-OS	-ML
TFR-48-P	48	4	4,602	4,807	3,384	3,066
TFR-54-P	54	6	5,605	5,831	4,222	3,755
TFR-60-P	60	6	6,562	6,802	5,055	4,422

SQUARE TABLES

MODEL #	LENGTH	WIDTH	SEATING CAPACITY	-OS	-ML
TFS-4848-P	48	48	4	3,384	3,066
TFS-5454-P	54	54	6	4,222	3,755
TFS-6060-P	60	60	6	5,055	4,422

SOFT SQUARE TABLES

MODEL #	LENGTH	WIDTH	SEATING CAPACITY	-OS	-ML
TFQ-4848-P	48	48	4	3,384	3,066
TFQ-5454-P	54	54	6	4,222	3,755
TFQ-6060-P	60	60	6	5,055	4,422

OPTIONS

CODE

PRICE

NOTES

Power & Data Options

See pages 112-122

Polished Chrome Finish Options:

Polished Chrome Open Frame Square

Add -PCOS

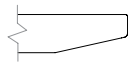
\$1,186

Polished Chrome Post Metal Legs

Add -PCML-TWB

\$1,284

EDGE PROFILE



Two4Six Cutback Edge

GENERAL INFORMATION

- Tops are 1-1/8"-thick with 3/16"-thick hardwood edge band
- Seating capacity based on 27" per person
- Overall table height 29.5"
- Standard with quarter cut veneer
- One section of wire management channel provided per table with Post Metal Leg and Open Frame Square Bases

REQUIRED INFORMATION (ORDER CANNOT BE ENTERED WITHOUT THIS INFORMATION)

See appendix pages vi-viii for surface material options.

- Choose Laminate Finish
- Choose Wood Species & Finish
- Choose Paint Finish, if -PC base is specified
- Choose Veneer Finish, if -VY base is specified
- Choose Metal Finish, if -OS or -ML base is specified (Clear Anodized (-CA) is an option on the Post Metal Leg only)



LAMINATE TOP WITH CUTBACK EDGE



ROUND TOP



SQUARE TOP



SOFT SQUARE TOP

BASE KEY

PC	Painted Cylinder
VY	Veneer Cylinder
OS	Open Frame Square
ML	Post Metal Leg

ROUND TABLES

MODEL #	DIAMETER	SEATING CAPACITY	-PC	-VY	-OS	-ML
TFR-48-PA	48	4	4,602	4,807	3,384	3,066
TFR-54-PA	54	6	5,605	5,831	4,222	3,755
TFR-60-PA	60	6	6,562	6,802	5,055	4,422

SQUARE TABLES

MODEL #	LENGTH	WIDTH	SEATING CAPACITY	-OS	-ML
TFS-4848-PA	48	48	4	3,384	3,066
TFS-5454-PA	54	54	6	4,222	3,755
TFS-6060-PA	60	60	6	5,055	4,422

SOFT SQUARE TABLES

MODEL #	LENGTH	WIDTH	SEATING CAPACITY	-OS	-ML
TFQ-4848-PA	48	48	4	3,384	3,066
TFQ-5454-PA	54	54	6	4,222	3,755
TFQ-6060-PA	60	60	6	5,055	4,422

OPTIONS

CODE

PRICE

NOTES

Power & Data Options

See pages 112-122

Polished Chrome Finish Options:

Polished Chrome Open Frame Square

Add -PCOS

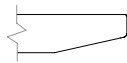
\$1,186

Polished Chrome Post Metal Legs

Add -PCML-TWB

\$1,284

EDGE PROFILE



Two4Six Cutback Edge

GENERAL INFORMATION

- Tops are 1-1/8"-thick
- Seating capacity based on 27" per person
- Overall table height 29.5"
- Standard with quarter cut veneer
- One section of wire management channel provided per table with Post Metal Leg and Open Frame Square Bases

REQUIRED INFORMATION (ORDER CANNOT BE ENTERED WITHOUT THIS INFORMATION)

See appendix pages vi-viii for surface material options.

- Choose Laminate Finish
- Choose Edge Band Finish
- Choose Paint Finish, if -PC base is specified
- Choose Veneer Finish, if -VY base is specified
- Choose Metal Finish, if -OS or -ML base is specified (Clear Anodized (-CA) is an option on the Post Metal Leg only)



LAMINATE TOP WITH SQUARE EDGE



ROUND TOP



SQUARE TOP



SOFT SQUARE TOP

BASE KEY

PC	Painted Cylinder
VY	Veneer Cylinder
OS	Open Frame Square
ML	Post Metal Leg

ROUND TABLES

MODEL #	DIAMETER	SEATING CAPACITY	-PC	-VY	-OS	-ML
TFR-48-PE	48	4	4,333	4,526	3,186	2,886
TFR-54-PE	54	6	5,277	5,490	3,975	3,536
TFR-60-PE	60	6	6,178	6,404	4,759	4,163

SQUARE TABLES

MODEL #	LENGTH	WIDTH	SEATING CAPACITY	-OS	-ML
TFS-4848-PE	48	48	4	2,619	2,360
TFS-5454-PE	54	54	6	3,094	2,738
TFS-6060-PE	60	60	6	3,681	3,204

SOFT SQUARE TABLES

MODEL #	LENGTH	WIDTH	SEATING CAPACITY	-OS	-ML
TFQ-4848-PE	48	48	4	2,414	2,188
TFQ-5454-PE	54	54	6	2,848	2,533
TFQ-6060-PE	60	60	6	3,383	2,959

OPTIONS

CODE

PRICE

NOTES

Power & Data Options

See pages 112-122

Polished Chrome Finish Options:

Polished Chrome Open Frame Square

Add -PCOS

\$1,186

Polished Chrome Post Metal Legs

Add -PCML-TWB

\$1,284

EDGE PROFILE



Two4Six Square Edge

GENERAL INFORMATION

- Tops are 1-1/8" thick
- Seating capacity based on 27" per person
- Overall table height 29.5"
- Standard with quarter cut veneer
- One section of wire management channel provided per table with Post Metal Leg and Open Frame Square Bases

REQUIRED INFORMATION (ORDER CANNOT BE ENTERED WITHOUT THIS INFORMATION)

See appendix pages vi-viii for surface material options.

- Choose Laminate Finish
- Choose Edge Band Finish
- Choose Paint Finish, if -PC base is specified
- Choose Veneer Finish, if -VY base is specified
- Choose Metal Finish, if -OS or -ML base is specified (Clear Anodized (-CA) is an option on the Post Metal Leg only)



GLASS TOP



ROUND TOP



SQUARE TOP



SOFT SQUARE TOP

BASE KEY

- PC Painted Cylinder
- VY Veneer Cylinder
- OS Open Frame Square

ROUND TABLES

MODEL #	DIAMETER	SEATING CAPACITY	-PC	-VY	-OS
TFR-48-G	48	4	8,941	9,339	6,573
TFR-54-G	54	6	10,888	11,328	8,201
TFR-60-G	60	6	12,747	13,214	9,819

SQUARE TABLES

MODEL #	LENGTH	WIDTH	SEATING CAPACITY	-OS
TFS-4848-G	48	48	4	6,573
TFS-5454-G	54	54	6	8,201
TFS-6060-G	60	60	6	9,819

SOFT SQUARE TABLES

MODEL #	LENGTH	WIDTH	SEATING CAPACITY	-OS
TFQ-4848-G	48	48	4	6,573
TFQ-5454-G	54	54	6	8,201
TFQ-6060-G	60	60	6	9,819

OPTIONS

Power & Data Options

CODE

PRICE

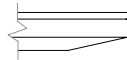
NOTES

See pages 112-122

Polished Chrome Finish Options:

- Polished Chrome Open Frame Square Add **-PCOS** \$1,186
- Polished Chrome Post Metal Legs Add **-PCML-TWB** \$1,284

EDGE PROFILE



Two4Six Glass Edge

GENERAL INFORMATION

- Tops are 1-1/8" -thick with 3/16" -thick hardwood edge band
- Seating capacity based on 27" per person
- Overall table height 29.5"
- Standard with quarter cut veneer
- One section of wire management channel provided per table with Post Metal Leg and Open Frame Square Bases

REQUIRED INFORMATION (ORDER CANNOT BE ENTERED WITHOUT THIS INFORMATION)

See appendix pages vi-viii for surface material options.

- Choose Glass Finish
- Choose Veneer Finish, if applicable
- Choose Metal Finish, if applicable
- Choose Paint Finish, if applicable
- Choose Sub-Top Finish: Paint Finish or Wood Species & Finish



SOLID SURFACE TOP



ROUND TOP



SQUARE TOP



SOFT SQUARE TOP

BASE KEY

- PC Painted Cylinder
- VY Veneer Cylinder
- OS Open Frame Square

ROUND TABLES

MODEL #	DIAMETER	SEATING CAPACITY	-PC	-VY	-OS
TFR-48-SS	48	4	9,342	9,758	6,868
TFR-54-SS	54	6	11,376	11,836	8,569
TFR-60-SS	60	6	13,319	13,807	10,260

SQUARE TABLES

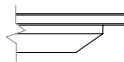
MODEL #	LENGTH	WIDTH	SEATING CAPACITY	-OS
TFS-4848-SS	48	48	4	6,868
TFS-5454-SS	54	54	6	8,569
TFS-6060-SS	60	60	6	10,260

SOFT SQUARE TABLES

MODEL #	LENGTH	WIDTH	SEATING CAPACITY	-OS
TFQ-4848-SS	48	48	4	6,868
TFQ-5454-SS	54	54	6	8,569
TFQ-6060-SS	60	60	6	10,260

OPTIONS	CODE	PRICE	NOTES
Power & Data Options			See pages 112-122
Polished Chrome Finish Options:			
Polished Chrome Open Frame Square	Add -PCOS	\$1,186	

EDGE PROFILE



Two4Six Solid Surface Edge

GENERAL INFORMATION

- Seating capacity based on 27" per person
- Overall table height 29.5"
- Standard with quarter cut veneer
- One section of wire management channel provided per table with Post Metal Leg and Open Frame Square Bases

REQUIRED INFORMATION (ORDER CANNOT BE ENTERED WITHOUT THIS INFORMATION)

See appendix pages vi-viii for surface material options.

- Choose Solid Surface Finish
- Choose Veneer Finish, if applicable
- Choose Metal Finish, if applicable
- Choose Paint Finish, if applicable



STONE / QUARTZ TOP



ROUND TOP



SQUARE TOP



SOFT SQUARE TOP

BASE KEY

- PC Painted Cylinder
- VY Veneer Cylinder
- OS Open Frame Square

ROUND TABLES

MODEL #	DIAMETER	SEATING CAPACITY	-PC	-VY	-OS
TFR-48-S	48	4	11,061	11,553	8,132
TFR-54-S	54	6	13,470	14,014	10,147

SQUARE TABLES

MODEL #	LENGTH	WIDTH	SEATING CAPACITY	-OS
TFS-4848-S	48	48	4	8,132
TFS-5454-S	54	54	6	10,147

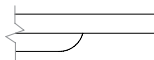
SOFT SQUARE TABLES

MODEL #	LENGTH	WIDTH	SEATING CAPACITY	-OS
TFQ-4848-S	48	48	4	8,132
TFQ-5454-S	54	54	6	10,147

OPTIONS

OPTIONS	CODE	PRICE	NOTES
Power & Data Options			See pages 112-122
Polished Chrome Finish Options:			
Polished Chrome Open Frame Square	Add -PCOS	\$1,186	

EDGE PROFILE



Two4Six Stone / Quartz Edge

GENERAL INFORMATION

- Seating capacity based on 27" per person
- Overall table height 29.5"
- One section of wire management channel provided per table with Post Metal Leg and Open Frame Square Bases

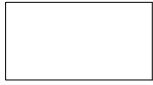
REQUIRED INFORMATION (ORDER CANNOT BE ENTERED WITHOUT THIS INFORMATION)

See appendix pages vi-viii for surface material options.

- Choose Stone/Quartz Finish
- Choose Veneer Finish, if applicable
- Choose Metal Finish
- Choose Paint Finish, if applicable



VENEER TOP WITH HARDWOOD EDGE



RECTANGLE TOP

BASE KEY

- OF Open Frame
- OFX Open Frame with X Center Base
- OFRP Open Frame with Painted Rectangle Center Base
- OFRV Open Frame with Veneer Rectangle Center Base

- RCL Laminate Racetrack Base
- RCP Painted Racetrack Base
- RCV Veneer Racetrack Base

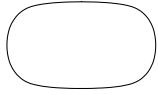
- ML Post Metal Leg
- MLX Post Metal Leg with X Center Base
- MLRP Post Metal Leg with Painted Rectangle Center Base
- MLRV Post Metal Leg with Veneer Rectangle Center Base

RECTANGLE TABLES

MODEL #	L x W	BASE QTY	TOP SECTIONS	SEATING CAPACITY	-OF	-OFX	-OFRP	-OFRV	-RCL	-RCP	-RCV	-ML	-MLX	-MLRP	-MLRV
TFT-6030-V	60 x 30	2	1	4	4,182	-	-	-	-	-	-	3,123	-	-	-
TFT-6036-V	60 x 36	2	1	4	4,397	-	-	-	-	-	-	3,287	-	-	-
TFT-6042-V	60 x 42	2	1	4	5,017	-	-	-	-	-	-	3,753	-	-	-
TFT-6048-V	60 x 48	2	1	4	5,432	-	-	-	-	-	-	4,067	-	-	-
TFT-6630-V	66 x 30	2	1	4	4,558	-	-	-	-	-	-	3,413	-	-	-
TFT-6636-V	66 x 36	2	1	4	4,808	-	-	-	-	-	-	3,603	-	-	-
TFT-6642-V	66 x 42	2	1	4	5,501	-	-	-	-	-	-	4,126	-	-	-
TFT-6648-V	66 x 48	2	1	4	5,973	-	-	-	-	-	-	4,483	-	-	-
TFT-7230-V	72 x 30	2	1	6	4,701	-	-	-	-	-	-	3,528	-	-	-
TFT-7236-V	72 x 36	2	1	6	4,974	-	-	-	-	-	-	3,736	-	-	-
TFT-7242-V	72 x 42	2	1	6	5,707	-	-	-	5,707	5,983	6,252	4,290	-	-	-
TFT-7248-V	72 x 48	2	1	6	6,211	-	-	-	6,211	6,497	6,775	4,672	-	-	-
TFT-7830-V	78 x 30	2	1	6	5,181	-	-	-	-	-	-	3,898	-	-	-
TFT-7836-V	78 x 36	2	1	6	5,497	-	-	-	-	-	-	4,139	-	-	-
TFT-7842-V	78 x 42	2	1	6	6,323	-	-	-	6,323	6,618	6,906	4,762	-	-	-
TFT-7848-V	78 x 48	2	1	6	6,898	-	-	-	6,898	7,202	7,500	5,198	-	-	-
TFT-8430-V	84 x 30	2	1	8	5,335	-	-	-	-	-	-	4,022	-	-	-
TFT-8436-V	84 x 36	2	1	8	5,676	-	-	-	-	-	-	4,282	-	-	-
TFT-8442-V	84 x 42	2	1	8	6,542	-	-	-	6,542	6,837	7,125	4,939	-	-	-
TFT-8448-V	84 x 48	2	1	8	7,152	-	-	-	7,152	7,457	7,755	5,401	-	-	-
TFT-9030-V	90 x 30	2	1	8	5,773	-	-	-	-	-	-	4,361	-	-	-
TFT-9036-V	90 x 36	2	1	8	6,157	-	-	-	-	-	-	4,654	-	-	-
TFT-9042-V	90 x 42	2	1	8	7,114	-	-	-	7,114	7,424	7,727	5,379	-	-	-
TFT-9048-V	90 x 48	2	1	8	7,791	-	-	-	7,791	8,112	8,426	5,894	-	-	-
TFT-9630-V	96 x 30	2	1	8	5,934	-	-	-	-	-	-	4,492	-	-	-
TFT-9636-V	96 x 36	2	1	8	6,344	-	-	-	-	-	-	4,804	-	-	-
TFT-9642-V	96 x 42	2	1	8	7,345	-	-	-	7,345	7,655	7,958	5,563	-	-	-
TFT-9648-V	96 x 48	2	1	8	8,059	-	-	-	8,059	8,379	8,693	6,106	-	-	-
TFT-10242-V	102 x 42	2	1	8	7,997	-	-	-	7,997	8,324	8,644	6,068	-	-	-
TFT-10248-V	102 x 48	2	1	8	8,789	-	-	-	8,789	9,128	9,459	6,670	-	-	-
TFT-10842-V	108 x 42	2	1	10	8,241	-	-	-	8,241	8,568	8,888	6,262	-	-	-
TFT-10848-V	108 x 48	2	1	10	9,072	-	-	-	9,072	9,410	9,741	6,894	-	-	-
TFT-10854-V	108 x 54	2	1	10	10,048	-	-	-	10,048	10,401	10,747	7,636	-	-	-
TFT-11442-V	114 x 42	2	1	10	8,930	-	-	-	8,930	9,275	9,612	6,796	-	-	-
TFT-11448-V	114 x 48	2	1	10	9,848	-	-	-	9,848	10,204	10,552	7,494	-	-	-
TFT-11454-V	114 x 54	2	1	12	10,920	-	-	-	10,920	11,292	11,656	8,310	-	-	-
TFT-12042-V	120 x 42	2	1	10	9,187	-	-	-	9,187	9,532	9,869	7,001	-	-	-
TFT-12048-V	120 x 48	2	1	10	10,145	-	-	-	10,145	10,501	10,850	7,730	-	-	-
TFT-12054-V	120 x 54	2	1	12	11,264	-	-	-	11,264	11,636	12,000	8,582	-	-	-
TFT-13242-V	132 x 42	2	2	10	10,105	-	-	-	10,105	10,463	10,814	7,720	-	-	-
TFT-13248-V	132 x 48	2	2	10	11,188	-	-	-	11,188	11,559	11,922	8,545	-	-	-
TFT-13254-V	132 x 54	2	2	12	12,451	-	-	-	12,451	12,839	13,218	9,507	-	-	-
TFT-14448-V	144 x 48	2	2	12	12,279	-	-	-	12,279	12,665	13,043	9,398	-	-	-
TFT-14454-V	144 x 54	2	2	14	13,695	-	-	-	13,695	14,099	14,493	10,478	-	-	-
TFT-14460-V	144 x 60	2	2	14	15,340	-	-	-	15,340	15,764	16,179	11,731	-	-	-
TFT-15648-V	156 x 48	3	2	14	-	15,657	15,657	15,657	15,657	16,242	16,814	-	12,005	12,005	12,005
TFT-15654-V	156 x 54	3	2	14	-	17,305	17,305	17,305	17,305	17,917	18,514	-	13,263	13,263	13,263
TFT-15660-V	156 x 60	3	2	14	-	19,228	19,228	19,228	19,228	19,872	20,501	-	14,730	14,730	14,730
TFT-16854-V	168 x 54	3	2	16	-	18,154	18,154	18,154	18,154	18,765	19,362	-	13,953	13,953	13,953
TFT-16860-V	168 x 60	3	2	16	-	20,199	20,199	20,199	20,199	20,842	21,471	-	15,517	15,517	15,517
TFT-18054-V	180 x 54	3	2	16	-	19,002	19,002	19,002	19,002	19,613	20,210	-	14,643	14,643	14,643
TFT-18060-V	180 x 60	3	2	16	-	21,169	21,169	21,169	21,169	21,813	22,442	-	16,303	16,303	16,303
TFT-19254-V	192 x 54	3	2	18	-	19,850	19,850	19,850	19,850	20,461	21,059	-	15,335	15,335	15,335
TFT-19260-V	192 x 60	3	2	18	-	22,139	22,139	22,139	22,139	22,783	23,412	-	17,088	17,088	17,088
TFT-20454-V	204 x 54	3	2	18	-	21,538	21,538	21,538	21,538	22,174	22,796	-	16,676	16,676	16,676
TFT-20460-V	204 x 60	3	2	18	-	24,048	24,048	24,048	24,048	24,718	25,372	-	18,601	18,601	18,601
TFT-21654-V	216 x 54	3	2	20	-	22,968	22,968	22,968	22,968	23,619	24,256	-	17,818	17,818	17,818
TFT-21660-V	216 x 60	3	2	20	-	25,670	25,670	25,670	25,670	26,356	27,026	-	19,893	19,893	19,893
TFT-22854-V	228 x 54	3	2	20	-	24,100	24,100	24,100	24,100	24,758	25,400	-	18,731	18,731	18,731
TFT-22860-V	228 x 60	3	2	20	-	26,958	26,958	26,958	26,958	27,651	28,328	-	20,928	20,928	20,928
TFT-24054-V	240 x 54	3	2	20	-	25,296	25,296	25,296	25,296	25,961	26,611	-	19,695	19,695	19,695
TFT-24060-V	240 x 60	3	2	20	-	28,319	28,319	28,319	28,319	29,020	29,704	-	22,019	22,019	22,019



VENEER TOP WITH HARDWOOD EDGE



SOFT RECTANGLE TOP

BASE KEY

- OF Open Frame
- OFX Open Frame with X Center Base
- OFRP Open Frame with Painted Rectangle Center Base
- OFRV Open Frame with Veneer Rectangle Center Base

- RCL Laminate Racetrack Base
- RCP Painted Racetrack Base
- RCV Veneer Racetrack Base

- ML Post Metal Leg
- MLX Post Metal Leg with X Center Base
- MLRP Post Metal Leg with Painted Rectangle Center Base
- MLRV Post Metal Leg with Veneer Rectangle Center Base

SOFT RECTANGLE TABLES

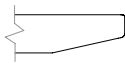
MODEL #	L x W	BASE QTY	TOP SECTIONS	SEATING CAPACITY	-OF	-OFX	-OFRP	-OFRV	-RCL	-RCP	-RCV	-ML	-MLX	-MLRP	-MLRV
TFF-6030-V	60 x 30	2	1	4	4,182	-	-	-	-	-	-	3,123	-	-	-
TFF-6036-V	60 x 36	2	1	4	4,397	-	-	-	-	-	-	3,287	-	-	-
TFF-6042-V	60 x 42	2	1	4	5,017	-	-	-	-	-	-	3,753	-	-	-
TFF-6048-V	60 x 48	2	1	4	5,432	-	-	-	-	-	-	4,067	-	-	-
TFF-6630-V	66 x 30	2	1	4	4,558	-	-	-	-	-	-	3,413	-	-	-
TFF-6636-V	66 x 36	2	1	4	4,808	-	-	-	-	-	-	3,603	-	-	-
TFF-6642-V	66 x 42	2	1	4	5,501	-	-	-	-	-	-	4,126	-	-	-
TFF-6648-V	66 x 48	2	1	4	5,973	-	-	-	-	-	-	4,483	-	-	-
TFF-7230-V	72 x 30	2	1	6	4,701	-	-	-	-	-	-	3,528	-	-	-
TFF-7236-V	72 x 36	2	1	6	4,974	-	-	-	-	-	-	3,736	-	-	-
TFF-7242-V	72 x 42	2	1	6	5,707	-	-	-	5,707	5,983	6,252	4,290	-	-	-
TFF-7248-V	72 x 48	2	1	6	6,211	-	-	-	6,211	6,497	6,775	4,672	-	-	-
TFF-7830-V	78 x 30	2	1	6	5,181	-	-	-	-	-	-	3,898	-	-	-
TFF-7836-V	78 x 36	2	1	6	5,497	-	-	-	-	-	-	4,139	-	-	-
TFF-7842-V	78 x 42	2	1	6	6,323	-	-	-	6,323	6,618	6,906	4,762	-	-	-
TFF-7848-V	78 x 48	2	1	6	6,898	-	-	-	6,898	7,202	7,500	5,198	-	-	-
TFF-8430-V	84 x 30	2	1	8	5,335	-	-	-	-	-	-	4,022	-	-	-
TFF-8436-V	84 x 36	2	1	8	5,676	-	-	-	-	-	-	4,282	-	-	-
TFF-8442-V	84 x 42	2	1	8	6,542	-	-	-	6,542	6,837	7,125	4,939	-	-	-
TFF-8448-V	84 x 48	2	1	8	7,152	-	-	-	7,152	7,457	7,755	5,401	-	-	-
TFF-9030-V	90 x 30	2	1	8	5,773	-	-	-	-	-	-	4,361	-	-	-
TFF-9036-V	90 x 36	2	1	8	6,157	-	-	-	-	-	-	4,654	-	-	-
TFF-9042-V	90 x 42	2	1	8	7,114	-	-	-	7,114	7,424	7,727	5,379	-	-	-
TFF-9048-V	90 x 48	2	1	8	7,791	-	-	-	7,791	8,112	8,426	5,894	-	-	-
TFF-9630-V	96 x 30	2	1	8	5,934	-	-	-	-	-	-	4,492	-	-	-
TFF-9636-V	96 x 36	2	1	8	6,344	-	-	-	-	-	-	4,804	-	-	-
TFF-9642-V	96 x 42	2	1	8	7,345	-	-	-	7,345	7,655	7,958	5,563	-	-	-
TFF-9648-V	96 x 48	2	1	8	8,059	-	-	-	8,059	8,379	8,693	6,106	-	-	-
TFF-10242-V	102 x 42	2	1	8	7,997	-	-	-	7,997	8,324	8,644	6,068	-	-	-
TFF-10248-V	102 x 48	2	1	8	8,789	-	-	-	8,789	9,128	9,459	6,670	-	-	-
TFF-10842-V	108 x 42	2	1	10	8,241	-	-	-	8,241	8,568	8,888	6,262	-	-	-
TFF-10848-V	108 x 48	2	1	10	9,072	-	-	-	9,072	9,410	9,741	6,894	-	-	-
TFF-10854-V	108 x 54	2	1	10	10,048	-	-	-	10,048	10,401	10,747	7,636	-	-	-
TFF-11442-V	114 x 42	2	1	10	8,930	-	-	-	8,930	9,275	9,612	6,796	-	-	-
TFF-11448-V	114 x 48	2	1	10	9,848	-	-	-	9,848	10,204	10,552	7,494	-	-	-
TFF-11454-V	114 x 54	2	1	12	10,920	-	-	-	10,920	11,292	11,656	8,310	-	-	-
TFF-12042-V	120 x 42	2	1	10	9,187	-	-	-	9,187	9,532	9,869	7,001	-	-	-
TFF-12048-V	120 x 48	2	1	10	10,145	-	-	-	10,145	10,501	10,850	7,730	-	-	-
TFF-12054-V	120 x 54	2	1	12	11,264	-	-	-	11,264	11,636	12,000	8,582	-	-	-
TFF-13242-V	132 x 42	2	2	10	10,105	-	-	-	10,105	10,463	10,814	7,720	-	-	-
TFF-13248-V	132 x 48	2	2	10	11,188	-	-	-	11,188	11,559	11,922	8,545	-	-	-
TFF-13254-V	132 x 54	2	2	12	12,451	-	-	-	12,451	12,839	13,218	9,507	-	-	-
TFF-14448-V	144 x 48	2	2	12	12,279	-	-	-	12,279	12,665	13,043	9,398	-	-	-
TFF-14454-V	144 x 54	2	2	14	13,695	-	-	-	13,695	14,099	14,493	10,478	-	-	-
TFF-14460-V	144 x 60	2	2	14	15,340	-	-	-	15,340	15,764	16,179	11,731	-	-	-
TFF-15648-V	156 x 48	3	2	14	-	15,657	15,657	15,657	15,657	16,242	16,814	-	12,005	12,005	12,005
TFF-15654-V	156 x 54	3	2	14	-	17,305	17,305	17,305	17,305	17,917	18,514	-	13,263	13,263	13,263
TFF-15660-V	156 x 60	3	2	14	-	19,228	19,228	19,228	19,228	19,872	20,501	-	14,730	14,730	14,730
TFF-16854-V	168 x 54	3	2	16	-	18,154	18,154	18,154	18,154	18,765	19,362	-	13,953	13,953	13,953
TFF-16860-V	168 x 60	3	2	16	-	20,199	20,199	20,199	20,199	20,842	21,471	-	15,517	15,517	15,517
TFF-18054-V	180 x 54	3	2	16	-	19,002	19,002	19,002	19,002	19,613	20,210	-	14,643	14,643	14,643
TFF-18060-V	180 x 60	3	2	16	-	21,169	21,169	21,169	21,169	21,813	22,442	-	16,303	16,303	16,303
TFF-19254-V	192 x 54	3	2	18	-	19,850	19,850	19,850	19,850	20,461	21,059	-	15,335	15,335	15,335
TFF-19260-V	192 x 60	3	2	18	-	22,139	22,139	22,139	22,139	22,783	23,412	-	17,088	17,088	17,088
TFF-20454-V	204 x 54	3	2	18	-	21,538	21,538	21,538	21,538	22,174	22,796	-	16,676	16,676	16,676
TFF-20460-V	204 x 60	3	2	18	-	24,048	24,048	24,048	24,048	24,718	25,372	-	18,601	18,601	18,601
TFF-21654-V	216 x 54	3	2	20	-	22,968	22,968	22,968	22,968	23,619	24,256	-	17,818	17,818	17,818
TFF-21660-V	216 x 60	3	2	20	-	25,670	25,670	25,670	25,670	26,356	27,026	-	19,893	19,893	19,893
TFF-22854-V	228 x 54	3	2	20	-	24,100	24,100	24,100	24,100	24,758	25,400	-	18,731	18,731	18,731
TFF-22860-V	228 x 60	3	2	20	-	26,958	26,958	26,958	26,958	27,651	28,328	-	20,928	20,928	20,928
TFF-24054-V	240 x 54	3	2	20	-	25,296	25,296	25,296	25,296	25,961	26,611	-	19,695	19,695	19,695
TFF-24060-V	240 x 60	3	2	20	-	28,319	28,319	28,319	28,319	29,020	29,704	-	22,019	22,019	22,019



VENEER TOP WITH HARDWOOD EDGE

OPTIONS	CODE	PRICE	NOTES
Power & Data Options			See pages 112-122
Polished Chrome Finish Options:			
Polished Chrome Open Frame Base	Add -PCOF-TWB	\$2,392	
Polished Chrome Post Metal Legs	Add -PCML-TWB	\$1,284	
Polished Chrome Open Frame with X-Center Base	Add -PCOFX-TWB	\$3,586	
Polished Chrome Post Metal Legs with X-Center Base	Add -PCMLX-TWB	\$2,478	
Multi-Section Tops:			
102", 108", 114" and 120" one-piece tops split into two sections	Specify -2	\$843	Note: Power Matrix (center of table location only) cannot be specified when this option is selected
204", 216", 228" or 240" two-piece tops split into four sections	Specify -4	\$1,681	

EDGE PROFILE



Two4Six Cutback Edge

GENERAL INFORMATION

- Tops are 1-1/8"-thick with 3/16"-thick hardwood edge band
- Seating capacity based on 27" per person
- Overall table height 29.5"
- Standard with quarter cut veneer
- One section of wire management channel provided per table with Post Metal Leg and Open Frame Square Bases
- Racetrack Bases have a removable access door

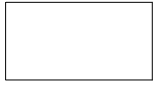
REQUIRED INFORMATION (ORDER CANNOT BE ENTERED WITHOUT THIS INFORMATION)

See appendix pages vi-viii for surface material options.

- Choose Veneer Finish
- Choose Metal Finish only if -OF or -ML bases specified (Clear Anodized (-CA) is an option on the Post Metal Leg only)
- Choose Solid Edge Band Finish or Coordinating Woodgrain Edge Band Finish, if -RCL Base specified
- Choose Beam Metal Finish for tables 102"-240"L, with a Racetrack Base (-RCL, -RCP, -RCV)



INSET LAMINATE TOP WITH HARDWOOD EDGE



RECTANGLE TOP

BASE KEY

- OF Open Frame
- OFX Open Frame with X Center Base
- OFRP Open Frame with Painted Rectangle Center Base
- OFRV Open Frame with Veneer Rectangle Center Base

- RCL Laminate Racetrack Base
- RCP Painted Racetrack Base
- RCV Veneer Racetrack Base

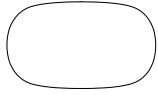
- ML Post Metal Leg
- MLX Post Metal Leg with X Center Base
- MLRP Post Metal Leg with Painted Rectangle Center Base
- MLRV Post Metal Leg with Veneer Rectangle Center Base

RECTANGLE TABLES

MODEL #	L x W	BASE QTY	TOP SECTIONS	SEATING CAPACITY	-OF	-OFX	-OFRP	-OFRV	-RCL	-RCP	-RCV	-ML	-MLX	-MLRP	-MLRV
TFT-6030-P	60 x 30	2	1	4	3,952	-	-	-	-	-	-	2,952	-	-	-
TFT-6036-P	60 x 36	2	1	4	4,156	-	-	-	-	-	-	3,107	-	-	-
TFT-6042-P	60 x 42	2	1	4	4,742	-	-	-	-	-	-	3,547	-	-	-
TFT-6048-P	60 x 48	2	1	4	5,134	-	-	-	-	-	-	3,844	-	-	-
TFT-6630-P	66 x 30	2	1	4	4,308	-	-	-	-	-	-	3,226	-	-	-
TFT-6636-P	66 x 36	2	1	4	4,544	-	-	-	-	-	-	3,405	-	-	-
TFT-6642-P	66 x 42	2	1	4	5,199	-	-	-	-	-	-	3,900	-	-	-
TFT-6648-P	66 x 48	2	1	4	5,645	-	-	-	-	-	-	4,237	-	-	-
TFT-7230-P	72 x 30	2	1	6	4,443	-	-	-	-	-	-	3,334	-	-	-
TFT-7236-P	72 x 36	2	1	6	4,701	-	-	-	-	-	-	3,531	-	-	-
TFT-7242-P	72 x 42	2	1	6	5,394	-	-	-	5,394	5,654	5,909	4,055	-	-	-
TFT-7248-P	72 x 48	2	1	6	5,870	-	-	-	5,870	6,140	6,403	4,416	-	-	-
TFT-7830-P	78 x 30	2	1	6	4,897	-	-	-	-	-	-	3,684	-	-	-
TFT-7836-P	78 x 36	2	1	6	5,195	-	-	-	-	-	-	3,912	-	-	-
TFT-7842-P	78 x 42	2	1	6	5,976	-	-	-	5,976	6,255	6,527	4,501	-	-	-
TFT-7848-P	78 x 48	2	1	6	6,519	-	-	-	6,519	6,806	7,088	4,913	-	-	-
TFT-8430-P	84 x 30	2	1	8	5,042	-	-	-	-	-	-	3,801	-	-	-
TFT-8436-P	84 x 36	2	1	8	5,364	-	-	-	-	-	-	4,047	-	-	-
TFT-8442-P	84 x 42	2	1	8	6,183	-	-	-	6,183	6,461	6,734	4,668	-	-	-
TFT-8448-P	84 x 48	2	1	8	6,759	-	-	-	6,759	7,047	7,329	5,104	-	-	-
TFT-9030-P	90 x 30	2	1	8	5,456	-	-	-	-	-	-	4,122	-	-	-
TFT-9036-P	90 x 36	2	1	8	5,819	-	-	-	-	-	-	4,399	-	-	-
TFT-9042-P	90 x 42	2	1	8	6,723	-	-	-	6,723	7,016	7,303	5,084	-	-	-
TFT-9048-P	90 x 48	2	1	8	7,363	-	-	-	7,363	7,666	7,963	5,570	-	-	-
TFT-9630-P	96 x 30	2	1	8	5,608	-	-	-	-	-	-	4,245	-	-	-
TFT-9636-P	96 x 36	2	1	8	5,996	-	-	-	-	-	-	4,540	-	-	-
TFT-9642-P	96 x 42	2	1	8	6,942	-	-	-	6,942	7,234	7,521	5,258	-	-	-
TFT-9648-P	96 x 48	2	1	8	7,616	-	-	-	7,616	7,919	8,215	5,771	-	-	-
TFT-10242-P	102 x 42	2	1	8	7,558	-	-	-	7,558	7,867	8,169	5,735	-	-	-
TFT-10248-P	102 x 48	2	1	8	8,306	-	-	-	8,306	8,626	8,939	6,304	-	-	-
TFT-10842-P	108 x 42	2	1	10	7,788	-	-	-	7,788	8,097	8,400	5,918	-	-	-
TFT-10848-P	108 x 48	2	1	10	8,574	-	-	-	8,574	8,893	9,206	6,515	-	-	-
TFT-10854-P	108 x 54	2	1	10	9,496	-	-	-	9,496	9,829	10,156	7,217	-	-	-
TFT-11442-P	114 x 42	2	1	10	8,439	-	-	-	8,439	8,765	9,084	6,423	-	-	-
TFT-11448-P	114 x 48	2	1	10	9,307	-	-	-	9,307	9,643	9,972	7,082	-	-	-
TFT-11454-P	114 x 54	2	1	12	10,320	-	-	-	10,320	10,671	11,015	7,853	-	-	-
TFT-12042-P	120 x 42	2	1	10	8,682	-	-	-	8,682	9,008	9,327	6,616	-	-	-
TFT-12048-P	120 x 48	2	1	10	9,588	-	-	-	9,588	9,924	10,254	7,305	-	-	-
TFT-12054-P	120 x 54	2	1	12	10,645	-	-	-	10,645	10,997	11,340	8,110	-	-	-
TFT-13242-P	132 x 42	2	2	10	9,550	-	-	-	9,550	9,888	10,220	7,296	-	-	-
TFT-13248-P	132 x 48	2	2	10	10,573	-	-	-	10,573	10,924	11,267	8,076	-	-	-
TFT-13254-P	132 x 54	2	2	12	11,767	-	-	-	11,767	12,133	12,492	8,985	-	-	-
TFT-14448-P	144 x 48	2	2	12	11,604	-	-	-	11,604	11,969	12,326	8,882	-	-	-
TFT-14454-P	144 x 54	2	2	14	12,942	-	-	-	12,942	13,324	13,696	9,902	-	-	-
TFT-14460-P	144 x 60	2	2	14	14,497	-	-	-	14,497	14,897	15,290	11,086	-	-	-
TFT-15648-P	156 x 48	3	2	14	-	14,796	14,796	14,796	14,796	15,349	15,890	-	11,345	11,345	11,345
TFT-15654-P	156 x 54	3	2	14	-	16,354	16,354	16,354	16,354	16,932	17,496	-	12,534	12,534	12,534
TFT-15660-P	156 x 60	3	2	14	-	18,171	18,171	18,171	18,171	18,780	19,374	-	13,920	13,920	13,920
TFT-16854-P	168 x 54	3	2	16	-	17,156	17,156	17,156	17,156	17,733	18,298	-	13,186	13,186	13,186
TFT-16860-P	168 x 60	3	2	16	-	19,089	19,089	19,089	19,089	19,696	20,291	-	14,664	14,664	14,664
TFT-18054-P	180 x 54	3	2	16	-	17,957	17,957	17,957	17,957	18,535	19,099	-	13,838	13,838	13,838
TFT-18060-P	180 x 60	3	2	16	-	20,005	20,005	20,005	20,005	20,614	21,208	-	15,407	15,407	15,407
TFT-19254-P	192 x 54	3	2	18	-	18,759	18,759	18,759	18,759	19,336	19,901	-	14,492	14,492	14,492
TFT-19260-P	192 x 60	3	2	18	-	20,922	20,922	20,922	20,922	21,530	22,125	-	16,149	16,149	16,149
TFT-20454-P	204 x 54	3	2	18	-	20,354	20,354	20,354	20,354	20,955	21,543	-	15,759	15,759	15,759
TFT-20460-P	204 x 60	3	2	18	-	22,726	22,726	22,726	22,726	23,359	23,977	-	17,578	17,578	17,578
TFT-21654-P	216 x 54	3	2	20	-	21,705	21,705	21,705	21,705	22,320	22,922	-	16,839	16,839	16,839
TFT-21660-P	216 x 60	3	2	20	-	24,259	24,259	24,259	24,259	24,907	25,540	-	18,799	18,799	18,799
TFT-22854-P	228 x 54	3	2	20	-	22,775	22,775	22,775	22,775	23,397	24,003	-	17,701	17,701	17,701
TFT-22860-P	228 x 60	3	2	20	-	25,476	25,476	25,476	25,476	26,131	26,770	-	19,777	19,777	19,777
TFT-24054-P	240 x 54	3	2	20	-	23,905	23,905	23,905	23,905	24,534	25,148	-	18,612	18,612	18,612
TFT-24060-P	240 x 60	3	2	20	-	26,762	26,762	26,762	26,762	27,424	28,071	-	20,808	20,808	20,808



INSET LAMINATE TOP WITH HARDWOOD EDGE



SOFT RECTANGLE TOP

BASE KEY

- OF Open Frame
- OFX Open Frame with X Center Base
- OFRP Open Frame with Painted Rectangle Center Base
- OFRV Open Frame with Veneer Rectangle Center Base

- RCL Laminate Racetrack Base
- RCP Painted Racetrack Base
- RCV Veneer Racetrack Base

- ML Post Metal Leg
- MLX Post Metal Leg with X Center Base
- MLRP Post Metal Leg with Painted Rectangle Center Base
- MLRV Post Metal Leg with Veneer Rectangle Center Base

SOFT RECTANGLE TABLES

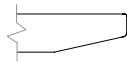
MODEL #	L x W	BASE QTY	TOP SECTIONS	SEATING CAPACITY	-OF	-OFX	-OFRP	-OFRV	-RCL	-RCP	-RCV	-ML	-MLX	-MLRP	-MLRV
TFF-6030-P	60 x 30	2	1	4	3,952	-	-	-	-	-	-	2,952	-	-	-
TFF-6036-P	60 x 36	2	1	4	4,156	-	-	-	-	-	-	3,107	-	-	-
TFF-6042-P	60 x 42	2	1	4	4,742	-	-	-	-	-	-	3,547	-	-	-
TFF-6048-P	60 x 48	2	1	4	5,134	-	-	-	-	-	-	3,844	-	-	-
TFF-6630-P	66 x 30	2	1	4	4,308	-	-	-	-	-	-	3,226	-	-	-
TFF-6636-P	66 x 36	2	1	4	4,544	-	-	-	-	-	-	3,405	-	-	-
TFF-6642-P	66 x 42	2	1	4	5,199	-	-	-	-	-	-	3,900	-	-	-
TFF-6648-P	66 x 48	2	1	4	5,645	-	-	-	-	-	-	4,237	-	-	-
TFF-7230-P	72 x 30	2	1	6	4,443	-	-	-	-	-	-	3,334	-	-	-
TFF-7236-P	72 x 36	2	1	6	4,701	-	-	-	-	-	-	3,531	-	-	-
TFF-7242-P	72 x 42	2	1	6	5,394	-	-	-	5,394	5,654	5,909	4,055	-	-	-
TFF-7248-P	72 x 48	2	1	6	5,870	-	-	-	5,870	6,140	6,403	4,416	-	-	-
TFF-7830-P	78 x 30	2	1	6	4,897	-	-	-	-	-	-	3,684	-	-	-
TFF-7836-P	78 x 36	2	1	6	5,195	-	-	-	-	-	-	3,912	-	-	-
TFF-7842-P	78 x 42	2	1	6	5,976	-	-	-	5,976	6,255	6,527	4,501	-	-	-
TFF-7848-P	78 x 48	2	1	6	6,519	-	-	-	6,519	6,806	7,088	4,913	-	-	-
TFF-8430-P	84 x 30	2	1	8	5,042	-	-	-	-	-	-	3,801	-	-	-
TFF-8436-P	84 x 36	2	1	8	5,364	-	-	-	-	-	-	4,047	-	-	-
TFF-8442-P	84 x 42	2	1	8	6,183	-	-	-	6,183	6,461	6,734	4,668	-	-	-
TFF-8448-P	84 x 48	2	1	8	6,759	-	-	-	6,759	7,047	7,329	5,104	-	-	-
TFF-9030-P	90 x 30	2	1	8	5,456	-	-	-	-	-	-	4,122	-	-	-
TFF-9036-P	90 x 36	2	1	8	5,819	-	-	-	-	-	-	4,399	-	-	-
TFF-9042-P	90 x 42	2	1	8	6,723	-	-	-	6,723	7,016	7,303	5,084	-	-	-
TFF-9048-P	90 x 48	2	1	8	7,363	-	-	-	7,363	7,666	7,963	5,570	-	-	-
TFF-9630-P	96 x 30	2	1	8	5,608	-	-	-	-	-	-	4,245	-	-	-
TFF-9636-P	96 x 36	2	1	8	5,996	-	-	-	-	-	-	4,540	-	-	-
TFF-9642-P	96 x 42	2	1	8	6,942	-	-	-	6,942	7,234	7,521	5,258	-	-	-
TFF-9648-P	96 x 48	2	1	8	7,616	-	-	-	7,616	7,919	8,215	5,771	-	-	-
TFF-10242-P	102 x 42	2	1	8	7,558	-	-	-	7,558	7,867	8,169	5,735	-	-	-
TFF-10248-P	102 x 48	2	1	8	8,306	-	-	-	8,306	8,626	8,939	6,304	-	-	-
TFF-10842-P	108 x 42	2	1	10	7,788	-	-	-	7,788	8,097	8,400	5,918	-	-	-
TFF-10848-P	108 x 48	2	1	10	8,574	-	-	-	8,574	8,893	9,206	6,515	-	-	-
TFF-10854-P	108 x 54	2	1	10	9,496	-	-	-	9,496	9,829	10,156	7,217	-	-	-
TFF-11442-P	114 x 42	2	1	10	8,439	-	-	-	8,439	8,765	9,084	6,423	-	-	-
TFF-11448-P	114 x 48	2	1	10	9,307	-	-	-	9,307	9,643	9,972	7,082	-	-	-
TFF-11454-P	114 x 54	2	1	12	10,320	-	-	-	10,320	10,671	11,015	7,853	-	-	-
TFF-12042-P	120 x 42	2	1	10	8,682	-	-	-	8,682	9,008	9,327	6,616	-	-	-
TFF-12048-P	120 x 48	2	1	10	9,588	-	-	-	9,588	9,924	10,254	7,305	-	-	-
TFF-12054-P	120 x 54	2	1	12	10,645	-	-	-	10,645	10,997	11,340	8,110	-	-	-
TFF-13242-P	132 x 42	2	2	10	9,550	-	-	-	9,550	9,888	10,220	7,296	-	-	-
TFF-13248-P	132 x 48	2	2	10	10,573	-	-	-	10,573	10,924	11,267	8,076	-	-	-
TFF-13254-P	132 x 54	2	2	12	11,767	-	-	-	11,767	12,133	12,492	8,985	-	-	-
TFF-14448-P	144 x 48	2	2	12	11,604	-	-	-	11,604	11,969	12,326	8,882	-	-	-
TFF-14454-P	144 x 54	2	2	14	12,942	-	-	-	12,942	13,324	13,696	9,902	-	-	-
TFF-14460-P	144 x 60	2	2	14	14,497	-	-	-	14,497	14,897	15,290	11,086	-	-	-
TFF-15648-P	156 x 48	3	2	14	-	14,796	14,796	14,796	14,796	15,349	15,890	-	11,345	11,345	11,345
TFF-15654-P	156 x 54	3	2	14	-	16,354	16,354	16,354	16,354	16,932	17,496	-	12,534	12,534	12,534
TFF-15660-P	156 x 60	3	2	14	-	18,171	18,171	18,171	18,171	18,780	19,374	-	13,920	13,920	13,920
TFF-16854-P	168 x 54	3	2	16	-	17,156	17,156	17,156	17,156	17,733	18,298	-	13,186	13,186	13,186
TFF-16860-P	168 x 60	3	2	16	-	19,089	19,089	19,089	19,089	19,696	20,291	-	14,664	14,664	14,664
TFF-18054-P	180 x 54	3	2	16	-	17,957	17,957	17,957	17,957	18,535	19,099	-	13,838	13,838	13,838
TFF-18060-P	180 x 60	3	2	16	-	20,005	20,005	20,005	20,005	20,614	21,208	-	15,407	15,407	15,407
TFF-19254-P	192 x 54	3	2	18	-	18,759	18,759	18,759	18,759	19,336	19,901	-	14,492	14,492	14,492
TFF-19260-P	192 x 60	3	2	18	-	20,922	20,922	20,922	20,922	21,530	22,125	-	16,149	16,149	16,149
TFF-20454-P	204 x 54	3	2	18	-	20,354	20,354	20,354	20,354	20,955	21,543	-	15,759	15,759	15,759
TFF-20460-P	204 x 60	3	2	18	-	22,726	22,726	22,726	22,726	23,359	23,977	-	17,578	17,578	17,578
TFF-21654-P	216 x 54	3	2	20	-	21,705	21,705	21,705	21,705	22,320	22,922	-	16,839	16,839	16,839
TFF-21660-P	216 x 60	3	2	20	-	24,259	24,259	24,259	24,259	24,907	25,540	-	18,799	18,799	18,799
TFF-22854-P	228 x 54	3	2	20	-	22,775	22,775	22,775	22,775	23,397	24,003	-	17,701	17,701	17,701
TFF-22860-P	228 x 60	3	2	20	-	25,476	25,476	25,476	25,476	26,131	26,770	-	19,777	19,777	19,777
TFF-24054-P	240 x 54	3	2	20	-	23,905	23,905	23,905	23,905	24,534	25,148	-	18,612	18,612	18,612
TFF-24060-P	240 x 60	3	2	20	-	26,762	26,762	26,762	26,762	27,424	28,071	-	20,808	20,808	20,808



INSET LAMINATE TOP WITH HARDWOOD EDGE

OPTIONS	CODE	PRICE	NOTES
Power & Data Options			See pages 112-122
Polished Chrome Finish Options:			
Polished Chrome Open Frame Base	Add -PCOF-TWB	\$2,392	
Polished Chrome Post Metal Legs	Add -PCML-TWB	\$1,284	
Polished Chrome Open Frame with X-Center Base	Add -PCOFX-TWB	\$3,586	
Polished Chrome Post Metal Legs with X-Center Base	Add -PCMLX-TWB	\$2,478	
Multi-Section Tops:			
102", 108", 114" and 120" one-piece tops split into two sections	Specify -2	\$843	Note: Power Matrix (center of table location only) cannot be specified when this option is selected
204", 216", 228" or 240" two-piece tops split into four sections	Specify -4	\$1,681	

EDGE PROFILE



Two4Six Cutback Edge

GENERAL INFORMATION

- Tops are 1-1/8"-thick
- Seating capacity based on 27" per person
- Overall table height 29.5"
- Standard with quarter cut veneer
- One section of wire management channel provided per table with Post Metal Leg and Open Frame Square Bases
- Racetrack Bases have a removable access door

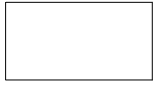
REQUIRED INFORMATION (ORDER CANNOT BE ENTERED WITHOUT THIS INFORMATION)

See appendix pages vi-viii for surface material options.

- Choose Laminate Finish
- Choose Wood Species & Finish for Hardwood Edge
- Choose Metal Finish only if -OF or -ML bases specified (Clear Anodized (-CA) is an option on the Post Metal Leg only)
- Choose Solid Edge Band Finish or Coordinating Woodgrain Edge Band Finish, if -RCL Base specified
- Choose Beam Metal Finish for tables 102"-240"L, with a Racetrack Base (-RCL, -RCP, -RCV)



LAMINATE TOP WITH CUTBACK EDGE



RECTANGLE TOP

BASE KEY

- OF Open Frame
- OFX Open Frame with X Center Base
- OFRP Open Frame with Painted Rectangle Center Base
- OFRV Open Frame with Veneer Rectangle Center Base

- RCL Laminate Racetrack Base
- RCP Painted Racetrack Base
- RCV Veneer Racetrack Base

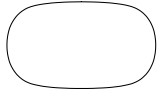
- ML Post Metal Leg
- MLX Post Metal Leg with X Center Base
- MLRP Post Metal Leg with Painted Rectangle Center Base
- MLRV Post Metal Leg with Veneer Rectangle Center Base

RECTANGLE TABLES

MODEL #	L x W	BASE QTY	TOP SECTIONS	SEATING CAPACITY	-OF	-OFX	-OFRP	-OFRV	-RCL	-RCP	-RCV	-ML	-MLX	-MLRP	-MLRV
TFT-6030-PA	60 x 30	2	1	4	3,952	-	-	-	-	-	-	2,952	-	-	-
TFT-6036-PA	60 x 36	2	1	4	4,156	-	-	-	-	-	-	3,107	-	-	-
TFT-6042-PA	60 x 42	2	1	4	4,742	-	-	-	-	-	-	3,547	-	-	-
TFT-6048-PA	60 x 48	2	1	4	5,134	-	-	-	-	-	-	3,844	-	-	-
TFT-6630-PA	66 x 30	2	1	4	4,308	-	-	-	-	-	-	3,226	-	-	-
TFT-6636-PA	66 x 36	2	1	4	4,544	-	-	-	-	-	-	3,405	-	-	-
TFT-6642-PA	66 x 42	2	1	4	5,199	-	-	-	-	-	-	3,900	-	-	-
TFT-6648-PA	66 x 48	2	1	4	5,645	-	-	-	-	-	-	4,237	-	-	-
TFT-7230-PA	72 x 30	2	1	6	4,443	-	-	-	-	-	-	3,334	-	-	-
TFT-7236-PA	72 x 36	2	1	6	4,701	-	-	-	-	-	-	3,531	-	-	-
TFT-7242-PA	72 x 42	2	1	6	5,394	-	-	-	5,394	5,654	5,909	4,055	-	-	-
TFT-7248-PA	72 x 48	2	1	6	5,870	-	-	-	5,870	6,140	6,403	4,416	-	-	-
TFT-7830-PA	78 x 30	2	1	6	4,897	-	-	-	-	-	-	3,684	-	-	-
TFT-7836-PA	78 x 36	2	1	6	5,195	-	-	-	-	-	-	3,912	-	-	-
TFT-7842-PA	78 x 42	2	1	6	5,976	-	-	-	5,976	6,255	6,527	4,501	-	-	-
TFT-7848-PA	78 x 48	2	1	6	6,519	-	-	-	6,519	6,806	7,088	4,913	-	-	-
TFT-8430-PA	84 x 30	2	1	8	5,042	-	-	-	-	-	-	3,801	-	-	-
TFT-8436-PA	84 x 36	2	1	8	5,364	-	-	-	-	-	-	4,047	-	-	-
TFT-8442-PA	84 x 42	2	1	8	6,183	-	-	-	6,183	6,461	6,734	4,668	-	-	-
TFT-8448-PA	84 x 48	2	1	8	6,759	-	-	-	6,759	7,047	7,329	5,104	-	-	-
TFT-9030-PA	90 x 30	2	1	8	5,456	-	-	-	-	-	-	4,122	-	-	-
TFT-9036-PA	90 x 36	2	1	8	5,819	-	-	-	-	-	-	4,399	-	-	-
TFT-9042-PA	90 x 42	2	1	8	6,723	-	-	-	6,723	7,016	7,303	5,084	-	-	-
TFT-9048-PA	90 x 48	2	1	8	7,363	-	-	-	7,363	7,666	7,963	5,570	-	-	-
TFT-9630-PA	96 x 30	2	1	8	5,608	-	-	-	-	-	-	4,245	-	-	-
TFT-9636-PA	96 x 36	2	1	8	5,996	-	-	-	-	-	-	4,540	-	-	-
TFT-9642-PA	96 x 42	2	1	8	6,942	-	-	-	6,942	7,234	7,521	5,258	-	-	-
TFT-9648-PA	96 x 48	2	1	8	7,616	-	-	-	7,616	7,919	8,215	5,771	-	-	-
TFT-10242-PA	102 x 42	2	1	8	7,558	-	-	-	7,558	7,867	8,169	5,735	-	-	-
TFT-10248-PA	102 x 48	2	1	8	8,306	-	-	-	8,306	8,626	8,939	6,304	-	-	-
TFT-10842-PA	108 x 42	2	1	10	7,788	-	-	-	7,788	8,097	8,400	5,918	-	-	-
TFT-10848-PA	108 x 48	2	1	10	8,574	-	-	-	8,574	8,893	9,206	6,515	-	-	-
TFT-10854-PA	108 x 54	2	1	10	9,496	-	-	-	9,496	9,829	10,156	7,217	-	-	-
TFT-11442-PA	114 x 42	2	1	10	8,439	-	-	-	8,439	8,765	9,084	6,423	-	-	-
TFT-11448-PA	114 x 48	2	1	10	9,307	-	-	-	9,307	9,643	9,972	7,082	-	-	-
TFT-11454-PA	114 x 54	2	1	12	10,320	-	-	-	10,320	10,671	11,015	7,853	-	-	-
TFT-12042-PA	120 x 42	2	1	10	8,682	-	-	-	8,682	9,008	9,327	6,616	-	-	-
TFT-12048-PA	120 x 48	2	1	10	9,588	-	-	-	9,588	9,924	10,254	7,305	-	-	-
TFT-12054-PA	120 x 54	2	1	12	10,645	-	-	-	10,645	10,997	11,340	8,110	-	-	-
TFT-13242-PA	132 x 42	2	2	10	9,550	-	-	-	9,550	9,888	10,220	7,296	-	-	-
TFT-13248-PA	132 x 48	2	2	10	10,573	-	-	-	10,573	10,924	11,267	8,076	-	-	-
TFT-13254-PA	132 x 54	2	2	12	11,767	-	-	-	11,767	12,133	12,492	8,985	-	-	-
TFT-14448-PA	144 x 48	2	2	12	11,604	-	-	-	11,604	11,969	12,326	8,882	-	-	-
TFT-14454-PA	144 x 54	2	2	14	12,942	-	-	-	12,942	13,324	13,696	9,902	-	-	-
TFT-14460-PA	144 x 60	2	2	14	14,497	-	-	-	14,497	14,897	15,290	11,086	-	-	-
TFT-15648-PA	156 x 48	3	2	14	-	14,796	14,796	14,796	14,796	15,349	15,890	-	11,345	11,345	11,345
TFT-15654-PA	156 x 54	3	2	14	-	16,354	16,354	16,354	16,354	16,932	17,496	-	12,534	12,534	12,534
TFT-15660-PA	156 x 60	3	2	14	-	18,171	18,171	18,171	18,171	18,780	19,374	-	13,920	13,920	13,920
TFT-16854-PA	168 x 54	3	2	16	-	17,156	17,156	17,156	17,156	17,733	18,298	-	13,186	13,186	13,186
TFT-16860-PA	168 x 60	3	2	16	-	19,089	19,089	19,089	19,089	19,696	20,291	-	14,664	14,664	14,664
TFT-18054-PA	180 x 54	3	2	16	-	17,957	17,957	17,957	17,957	18,535	19,099	-	13,838	13,838	13,838
TFT-18060-PA	180 x 60	3	2	16	-	20,005	20,005	20,005	20,005	20,614	21,208	-	15,407	15,407	15,407
TFT-19254-PA	192 x 54	3	2	18	-	18,759	18,759	18,759	18,759	19,336	19,901	-	14,492	14,492	14,492
TFT-19260-PA	192 x 60	3	2	18	-	20,922	20,922	20,922	20,922	21,530	22,125	-	16,149	16,149	16,149
TFT-20454-PA	204 x 54	3	2	18	-	20,354	20,354	20,354	20,354	20,955	21,543	-	15,759	15,759	15,759
TFT-20460-PA	204 x 60	3	2	18	-	22,726	22,726	22,726	22,726	23,359	23,977	-	17,578	17,578	17,578
TFT-21654-PA	216 x 54	3	2	20	-	21,705	21,705	21,705	21,705	22,320	22,922	-	16,839	16,839	16,839
TFT-21660-PA	216 x 60	3	2	20	-	24,259	24,259	24,259	24,259	24,907	25,540	-	18,799	18,799	18,799
TFT-22854-PA	228 x 54	3	2	20	-	22,775	22,775	22,775	22,775	23,397	24,003	-	17,701	17,701	17,701
TFT-22860-PA	228 x 60	3	2	20	-	25,476	25,476	25,476	25,476	26,131	26,770	-	19,777	19,777	19,777
TFT-24054-PA	240 x 54	3	2	20	-	23,905	23,905	23,905	23,905	24,534	25,148	-	18,612	18,612	18,612
TFT-24060-PA	240 x 60	3	2	20	-	26,762	26,762	26,762	26,762	27,424	28,071	-	20,808	20,808	20,808



LAMINATE TOP WITH CUTBACK EDGE



SOFT RECTANGLE TOP

BASE KEY

- OF Open Frame
- OFX Open Frame with X Center Base
- OFRP Open Frame with Painted Rectangle Center Base
- OFRV Open Frame with Veneer Rectangle Center Base

- RCL Laminate Racetrack Base
- RCP Painted Racetrack Base
- RCV Veneer Racetrack Base

- ML Post Metal Leg
- MLX Post Metal Leg with X Center Base
- MLRP Post Metal Leg with Painted Rectangle Center Base
- MLRV Post Metal Leg with Veneer Rectangle Center Base

SOFT RECTANGLE TABLES

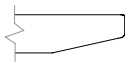
MODEL #	L x W	BASE QTY	TOP SECTIONS	SEATING CAPACITY	-OF	-OFX	-OFRP	-OFRV	-RCL	-RCP	-RCV	-ML	-MLX	-MLRP	-MLRV
TFF-6030-PA	60 x 30	2	1	4	3,952	-	-	-	-	-	-	2,952	-	-	-
TFF-6036-PA	60 x 36	2	1	4	4,156	-	-	-	-	-	-	3,107	-	-	-
TFF-6042-PA	60 x 42	2	1	4	4,742	-	-	-	-	-	-	3,547	-	-	-
TFF-6048-PA	60 x 48	2	1	4	5,134	-	-	-	-	-	-	3,844	-	-	-
TFF-6630-PA	66 x 30	2	1	4	4,308	-	-	-	-	-	-	3,226	-	-	-
TFF-6636-PA	66 x 36	2	1	4	4,544	-	-	-	-	-	-	3,405	-	-	-
TFF-6642-PA	66 x 42	2	1	4	5,199	-	-	-	-	-	-	3,900	-	-	-
TFF-6648-PA	66 x 48	2	1	4	5,645	-	-	-	-	-	-	4,237	-	-	-
TFF-7230-PA	72 x 30	2	1	6	4,443	-	-	-	-	-	-	3,334	-	-	-
TFF-7236-PA	72 x 36	2	1	6	4,701	-	-	-	-	-	-	3,531	-	-	-
TFF-7242-PA	72 x 42	2	1	6	5,394	-	-	-	5,394	5,654	5,909	4,055	-	-	-
TFF-7248-PA	72 x 48	2	1	6	5,870	-	-	-	5,870	6,140	6,403	4,416	-	-	-
TFF-7830-PA	78 x 30	2	1	6	4,897	-	-	-	-	-	-	3,684	-	-	-
TFF-7836-PA	78 x 36	2	1	6	5,195	-	-	-	-	-	-	3,912	-	-	-
TFF-7842-PA	78 x 42	2	1	6	5,976	-	-	-	5,976	6,255	6,527	4,501	-	-	-
TFF-7848-PA	78 x 48	2	1	6	6,519	-	-	-	6,519	6,806	7,088	4,913	-	-	-
TFF-8430-PA	84 x 30	2	1	8	5,042	-	-	-	-	-	-	3,801	-	-	-
TFF-8436-PA	84 x 36	2	1	8	5,364	-	-	-	-	-	-	4,047	-	-	-
TFF-8442-PA	84 x 42	2	1	8	6,183	-	-	-	6,183	6,461	6,734	4,668	-	-	-
TFF-8448-PA	84 x 48	2	1	8	6,759	-	-	-	6,759	7,047	7,329	5,104	-	-	-
TFF-9030-PA	90 x 30	2	1	8	5,456	-	-	-	-	-	-	4,122	-	-	-
TFF-9036-PA	90 x 36	2	1	8	5,819	-	-	-	-	-	-	4,399	-	-	-
TFF-9042-PA	90 x 42	2	1	8	6,723	-	-	-	6,723	7,016	7,303	5,084	-	-	-
TFF-9048-PA	90 x 48	2	1	8	7,363	-	-	-	7,363	7,666	7,963	5,570	-	-	-
TFF-9630-PA	96 x 30	2	1	8	5,608	-	-	-	-	-	-	4,245	-	-	-
TFF-9636-PA	96 x 36	2	1	8	5,996	-	-	-	-	-	-	4,540	-	-	-
TFF-9642-PA	96 x 42	2	1	8	6,942	-	-	-	6,942	7,234	7,521	5,258	-	-	-
TFF-9648-PA	96 x 48	2	1	8	7,616	-	-	-	7,616	7,919	8,215	5,771	-	-	-
TFF-10242-PA	102 x 42	2	1	8	7,558	-	-	-	7,558	7,867	8,169	5,735	-	-	-
TFF-10248-PA	102 x 48	2	1	8	8,306	-	-	-	8,306	8,626	8,939	6,304	-	-	-
TFF-10842-PA	108 x 42	2	1	10	7,788	-	-	-	7,788	8,097	8,400	5,918	-	-	-
TFF-10848-PA	108 x 48	2	1	10	8,574	-	-	-	8,574	8,893	9,206	6,515	-	-	-
TFF-10854-PA	108 x 54	2	1	10	9,496	-	-	-	9,496	9,829	10,156	7,217	-	-	-
TFF-11442-PA	114 x 42	2	1	10	8,439	-	-	-	8,439	8,765	9,084	6,423	-	-	-
TFF-11448-PA	114 x 48	2	1	10	9,307	-	-	-	9,307	9,643	9,972	7,082	-	-	-
TFF-11454-PA	114 x 54	2	1	12	10,320	-	-	-	10,320	10,671	11,015	7,853	-	-	-
TFF-12042-PA	120 x 42	2	1	10	8,682	-	-	-	8,682	9,008	9,327	6,616	-	-	-
TFF-12048-PA	120 x 48	2	1	10	9,588	-	-	-	9,588	9,924	10,254	7,305	-	-	-
TFF-12054-PA	120 x 54	2	1	12	10,645	-	-	-	10,645	10,997	11,340	8,110	-	-	-
TFF-13242-PA	132 x 42	2	2	10	9,550	-	-	-	9,550	9,888	10,220	7,296	-	-	-
TFF-13248-PA	132 x 48	2	2	10	10,573	-	-	-	10,573	10,924	11,267	8,076	-	-	-
TFF-13254-PA	132 x 54	2	2	12	11,767	-	-	-	11,767	12,133	12,492	8,985	-	-	-
TFF-14448-PA	144 x 48	2	2	12	11,604	-	-	-	11,604	11,969	12,326	8,882	-	-	-
TFF-14454-PA	144 x 54	2	2	14	12,942	-	-	-	12,942	13,324	13,696	9,902	-	-	-
TFF-14460-PA	144 x 60	2	2	14	14,497	-	-	-	14,497	14,897	15,290	11,086	-	-	-
TFF-15648-PA	156 x 48	3	2	14	-	14,796	14,796	14,796	14,796	15,349	15,890	-	11,345	11,345	11,345
TFF-15654-PA	156 x 54	3	2	14	-	16,354	16,354	16,354	16,354	16,932	17,496	-	12,534	12,534	12,534
TFF-15660-PA	156 x 60	3	2	14	-	18,171	18,171	18,171	18,171	18,780	19,374	-	13,920	13,920	13,920
TFF-16854-PA	168 x 54	3	2	16	-	17,156	17,156	17,156	17,156	17,733	18,298	-	13,186	13,186	13,186
TFF-16860-PA	168 x 60	3	2	16	-	19,089	19,089	19,089	19,089	19,696	20,291	-	14,664	14,664	14,664
TFF-18054-PA	180 x 54	3	2	16	-	17,957	17,957	17,957	17,957	18,535	19,099	-	13,838	13,838	13,838
TFF-18060-PA	180 x 60	3	2	16	-	20,005	20,005	20,005	20,005	20,614	21,208	-	15,407	15,407	15,407
TFF-19254-PA	192 x 54	3	2	18	-	18,759	18,759	18,759	18,759	19,336	19,901	-	14,492	14,492	14,492
TFF-19260-PA	192 x 60	3	2	18	-	20,922	20,922	20,922	20,922	21,530	22,125	-	16,149	16,149	16,149
TFF-20454-PA	204 x 54	3	2	18	-	20,354	20,354	20,354	20,354	20,955	21,543	-	15,759	15,759	15,759
TFF-20460-PA	204 x 60	3	2	18	-	22,726	22,726	22,726	22,726	23,359	23,977	-	17,578	17,578	17,578
TFF-21654-PA	216 x 54	3	2	20	-	21,705	21,705	21,705	21,705	22,320	22,922	-	16,839	16,839	16,839
TFF-21660-PA	216 x 60	3	2	20	-	24,259	24,259	24,259	24,259	24,907	25,540	-	18,799	18,799	18,799
TFF-22854-PA	228 x 54	3	2	20	-	22,775	22,775	22,775	22,775	23,397	24,003	-	17,701	17,701	17,701
TFF-22860-PA	228 x 60	3	2	20	-	25,476	25,476	25,476	25,476	26,131	26,770	-	19,777	19,777	19,777
TFF-24054-PA	240 x 54	3	2	20	-	23,905	23,905	23,905	23,905	24,534	25,148	-	18,612	18,612	18,612
TFF-24060-PA	240 x 60	3	2	20	-	26,762	26,762	26,762	26,762	27,424	28,071	-	20,808	20,808	20,808



LAMINATE TOP WITH CUTBACK EDGE

OPTIONS	CODE	PRICE	NOTES
Power & Data Options			See pages 112-122
Polished Chrome Finish Options:			
Polished Chrome Open Frame Base	Add -PCOF-TWB	\$2,392	
Polished Chrome Post Metal Legs	Add -PCML-TWB	\$1,284	
Polished Chrome Open Frame with X-Center Base	Add -PCOFX-TWB	\$3,586	
Polished Chrome Post Metal Legs with X-Center Base	Add -PCMLX-TWB	\$2,478	
Multi-Section Tops:			
102", 108", 114" and 120" one-piece tops split into two sections	Specify -2	\$843	Note: Power Matrix (center of table location only) cannot be specified when this option is selected
204", 216", 228" or 240" two-piece tops split into four sections	Specify -4	\$1,681	

EDGE PROFILE



Two4Six Cutback Edge

GENERAL INFORMATION

- Tops are 1-1/8"-thick
- Seating capacity based on 27" per person
- Overall table height 29.5"
- Standard with quarter cut veneer
- One section of wire management channel provided per table with Post Metal Leg and Open Frame Square Bases
- Racetrack Bases have a removable access door

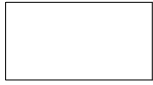
REQUIRED INFORMATION (ORDER CANNOT BE ENTERED WITHOUT THIS INFORMATION)

See appendix pages vi-viii for surface material options.

- Choose Laminate Finish
- Choose Metal Finish only if -OF or -ML bases specified (Clear Anodized (-CA) is an option on the Post Metal Leg only)
- Choose Solid Edge Band Finish or Coordinating Woodgrain Edge Band Finish
- Choose Beam Metal Finish for tables 102"-240"L, with a Racetrack Base (-RCL, -RCP, -RCV)



LAMINATE TOP WITH SQUARE EDGE



RECTANGLE TOP

BASE KEY

- OF Open Frame
- OFX Open Frame with X Center Base
- OFRP Open Frame with Painted Rectangle Center Base
- OFRV Open Frame with Veneer Rectangle Center Base

- RCL Laminate Racetrack Base
- RCP Painted Racetrack Base
- RCV Veneer Racetrack Base

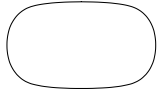
- ML Post Metal Leg
- MLX Post Metal Leg with X Center Base
- MLRP Post Metal Leg with Painted Rectangle Center Base
- MLRV Post Metal Leg with Veneer Rectangle Center Base

RECTANGLE TABLES

MODEL #	L x W	BASE QTY	TOP SECTIONS	SEATING CAPACITY	-OF	-OFX	-OFRP	-OFRV	-RCL	-RCP	-RCV	-ML	-MLX	-MLRP	-MLRV
TFT-6030-PE	60 x 30	2	1	4	3,555	-	-	-	-	-	-	2,168	-	-	-
TFT-6036-PE	60 x 36	2	1	4	3,738	-	-	-	-	-	-	2,282	-	-	-
TFT-6042-PE	60 x 42	2	1	4	4,265	-	-	-	-	-	-	2,605	-	-	-
TFT-6048-PE	60 x 48	2	1	4	4,618	-	-	-	-	-	-	2,823	-	-	-
TFT-6630-PE	66 x 30	2	1	4	3,875	-	-	-	-	-	-	2,369	-	-	-
TFT-6636-PE	66 x 36	2	1	4	4,087	-	-	-	-	-	-	2,501	-	-	-
TFT-6642-PE	66 x 42	2	1	4	4,676	-	-	-	-	-	-	2,864	-	-	-
TFT-6648-PE	66 x 48	2	1	4	5,078	-	-	-	-	-	-	3,112	-	-	-
TFT-7230-PE	72 x 30	2	1	6	3,996	-	-	-	-	-	-	2,449	-	-	-
TFT-7236-PE	72 x 36	2	1	6	4,228	-	-	-	-	-	-	2,593	-	-	-
TFT-7242-PE	72 x 42	2	1	6	4,851	-	-	-	4,851	5,086	5,315	2,978	-	-	-
TFT-7248-PE	72 x 48	2	1	6	5,280	-	-	-	5,280	5,523	5,759	3,243	-	-	-
TFT-7830-PE	78 x 30	2	1	6	4,404	-	-	-	-	-	-	2,706	-	-	-
TFT-7836-PE	78 x 36	2	1	6	4,673	-	-	-	-	-	-	2,873	-	-	-
TFT-7842-PE	78 x 42	2	1	6	5,375	-	-	-	5,375	5,626	5,871	3,305	-	-	-
TFT-7848-PE	78 x 48	2	1	6	5,864	-	-	-	5,864	6,122	6,375	3,608	-	-	-
TFT-8430-PE	84 x 30	2	1	8	4,535	-	-	-	-	-	-	2,792	-	-	-
TFT-8436-PE	84 x 36	2	1	8	4,825	-	-	-	-	-	-	2,972	-	-	-
TFT-8442-PE	84 x 42	2	1	8	5,561	-	-	-	5,561	5,812	6,057	3,428	-	-	-
TFT-8448-PE	84 x 48	2	1	8	6,080	-	-	-	6,080	6,339	6,592	3,749	-	-	-
TFT-9030-PE	90 x 30	2	1	8	4,908	-	-	-	-	-	-	3,027	-	-	-
TFT-9036-PE	90 x 36	2	1	8	5,234	-	-	-	-	-	-	3,230	-	-	-
TFT-9042-PE	90 x 42	2	1	8	6,047	-	-	-	6,047	6,311	6,568	3,734	-	-	-
TFT-9048-PE	90 x 48	2	1	8	6,623	-	-	-	6,623	6,896	7,163	4,091	-	-	-
TFT-9630-PE	96 x 30	2	1	8	5,044	-	-	-	-	-	-	3,118	-	-	-
TFT-9636-PE	96 x 36	2	1	8	5,393	-	-	-	-	-	-	3,334	-	-	-
TFT-9642-PE	96 x 42	2	1	8	6,244	-	-	-	6,244	6,507	6,765	3,861	-	-	-
TFT-9648-PE	96 x 48	2	1	8	6,851	-	-	-	6,851	7,123	7,390	4,238	-	-	-
TFT-10242-PE	102 x 42	2	1	8	6,798	-	-	-	6,798	7,076	7,348	4,212	-	-	-
TFT-10248-PE	102 x 48	2	1	8	7,471	-	-	-	7,471	7,759	8,041	4,629	-	-	-
TFT-10842-PE	108 x 42	2	1	10	7,005	-	-	-	7,005	7,283	7,555	4,346	-	-	-
TFT-10848-PE	108 x 48	2	1	10	7,712	-	-	-	7,712	7,999	8,280	4,785	-	-	-
TFT-10854-PE	108 x 54	2	1	10	8,541	-	-	-	8,541	8,841	9,135	6,491	-	-	-
TFT-11442-PE	114 x 42	2	1	10	7,591	-	-	-	7,591	7,884	8,171	4,717	-	-	-
TFT-11448-PE	114 x 48	2	1	10	8,371	-	-	-	8,371	8,674	8,970	5,201	-	-	-
TFT-11454-PE	114 x 54	2	1	12	9,282	-	-	-	9,282	9,599	9,908	5,768	-	-	-
TFT-12042-PE	120 x 42	2	1	10	7,809	-	-	-	7,809	8,103	8,389	4,859	-	-	-
TFT-12048-PE	120 x 48	2	1	10	8,624	-	-	-	8,624	8,926	9,223	5,365	-	-	-
TFT-12054-PE	120 x 54	2	1	12	9,575	-	-	-	9,575	9,891	10,200	5,956	-	-	-
TFT-13242-PE	132 x 42	2	2	10	8,590	-	-	-	8,590	8,894	9,192	5,358	-	-	-
TFT-13248-PE	132 x 48	2	2	10	9,510	-	-	-	9,510	9,826	10,134	5,931	-	-	-
TFT-13254-PE	132 x 54	2	2	12	10,584	-	-	-	10,584	10,914	11,236	6,598	-	-	-
TFT-14448-PE	144 x 48	2	2	12	10,438	-	-	-	10,438	10,766	11,087	6,523	-	-	-
TFT-14454-PE	144 x 54	2	2	14	11,641	-	-	-	11,641	11,985	12,320	7,272	-	-	-
TFT-14460-PE	144 x 60	2	2	14	13,039	-	-	-	13,039	13,400	13,753	8,142	-	-	-
TFT-15648-PE	156 x 48	3	2	14	-	13,309	13,309	13,309	13,309	13,806	14,292	-	8,332	8,332	8,332
TFT-15654-PE	156 x 54	3	2	14	-	14,710	14,710	14,710	14,710	15,230	15,737	-	9,205	9,205	9,205
TFT-15660-PE	156 x 60	3	2	14	-	16,344	16,344	16,344	16,344	16,892	17,426	-	10,223	10,223	10,223
TFT-16854-PE	168 x 54	3	2	16	-	15,431	15,431	15,431	15,431	15,951	16,458	-	9,684	9,684	9,684
TFT-16860-PE	168 x 60	3	2	16	-	17,170	17,170	17,170	17,170	17,716	18,251	-	10,769	10,769	10,769
TFT-18054-PE	180 x 54	3	2	16	-	16,152	16,152	16,152	16,152	16,672	17,179	-	10,163	10,163	10,163
TFT-18060-PE	180 x 60	3	2	16	-	17,994	17,994	17,994	17,994	18,542	19,076	-	11,315	11,315	11,315
TFT-19254-PE	192 x 54	3	2	18	-	16,873	16,873	16,873	16,873	17,392	17,901	-	10,643	10,643	10,643
TFT-19260-PE	192 x 60	3	2	18	-	18,819	18,819	18,819	18,819	19,366	19,901	-	11,860	11,860	11,860
TFT-20454-PE	204 x 54	3	2	18	-	18,308	18,308	18,308	18,308	18,848	19,377	-	11,574	11,574	11,574
TFT-20460-PE	204 x 60	3	2	18	-	20,441	20,441	20,441	20,441	21,011	21,567	-	12,910	12,910	12,910
TFT-21654-PE	216 x 54	3	2	20	-	19,523	19,523	19,523	19,523	20,077	20,618	-	12,366	12,366	12,366
TFT-21660-PE	216 x 60	3	2	20	-	21,820	21,820	21,820	21,820	22,403	22,973	-	13,806	13,806	13,806
TFT-22854-PE	228 x 54	3	2	20	-	20,485	20,485	20,485	20,485	21,045	21,590	-	13,000	13,000	13,000
TFT-22860-PE	228 x 60	3	2	20	-	22,915	22,915	22,915	22,915	23,504	24,079	-	14,525	14,525	14,525
TFT-24054-PE	240 x 54	3	2	20	-	21,502	21,502	21,502	21,502	22,067	22,620	-	13,669	13,669	13,669
TFT-24060-PE	240 x 60	3	2	20	-	24,072	24,072	24,072	24,072	24,667	25,249	-	15,282	15,282	15,282



LAMINATE TOP WITH SQUARE EDGE



SOFT RECTANGLE TOP

BASE KEY

- OF Open Frame
- OFX Open Frame with X Center Base
- OFRP Open Frame with Painted Rectangle Center Base
- OFRV Open Frame with Veneer Rectangle Center Base

- RCL Laminate Racetrack Base
- RCP Painted Racetrack Base
- RCV Veneer Racetrack Base

- ML Post Metal Leg
- MLX Post Metal Leg with X Center Base
- MLRP Post Metal Leg with Painted Rectangle Center Base
- MLRV Post Metal Leg with Veneer Rectangle Center Base

SOFT RECTANGLE TABLES

MODEL #	L x W	BASE QTY	TOP SECTIONS	SEATING CAPACITY	-OF	-OFX	-OFRP	-OFRV	-RCL	-RCP	-RCV	-ML	-MLX	-MLRP	-MLRV
TFF-6030-PE	60 x 30	2	1	4	3,555	-	-	-	-	-	-	2,168	-	-	-
TFF-6036-PE	60 x 36	2	1	4	3,738	-	-	-	-	-	-	2,282	-	-	-
TFF-6042-PE	60 x 42	2	1	4	4,265	-	-	-	-	-	-	2,605	-	-	-
TFF-6048-PE	60 x 48	2	1	4	4,618	-	-	-	-	-	-	2,823	-	-	-
TFF-6630-PE	66 x 30	2	1	4	3,875	-	-	-	-	-	-	2,369	-	-	-
TFF-6636-PE	66 x 36	2	1	4	4,087	-	-	-	-	-	-	2,501	-	-	-
TFF-6642-PE	66 x 42	2	1	4	4,676	-	-	-	-	-	-	2,864	-	-	-
TFF-6648-PE	66 x 48	2	1	4	5,078	-	-	-	-	-	-	3,112	-	-	-
TFF-7230-PE	72 x 30	2	1	6	3,996	-	-	-	-	-	-	2,449	-	-	-
TFF-7236-PE	72 x 36	2	1	6	4,228	-	-	-	-	-	-	2,593	-	-	-
TFF-7242-PE	72 x 42	2	1	6	4,851	-	-	-	4,851	5,086	5,315	2,978	-	-	-
TFF-7248-PE	72 x 48	2	1	6	5,280	-	-	-	5,280	5,523	5,759	3,243	-	-	-
TFF-7830-PE	78 x 30	2	1	6	4,404	-	-	-	-	-	-	2,706	-	-	-
TFF-7836-PE	78 x 36	2	1	6	4,673	-	-	-	-	-	-	2,873	-	-	-
TFF-7842-PE	78 x 42	2	1	6	5,375	-	-	-	5,375	5,626	5,871	3,305	-	-	-
TFF-7848-PE	78 x 48	2	1	6	5,864	-	-	-	5,864	6,122	6,375	3,608	-	-	-
TFF-8430-PE	84 x 30	2	1	8	4,535	-	-	-	-	-	-	2,792	-	-	-
TFF-8436-PE	84 x 36	2	1	8	4,825	-	-	-	-	-	-	2,972	-	-	-
TFF-8442-PE	84 x 42	2	1	8	5,561	-	-	-	5,561	5,812	6,057	3,428	-	-	-
TFF-8448-PE	84 x 48	2	1	8	6,080	-	-	-	6,080	6,339	6,592	3,749	-	-	-
TFF-9030-PE	90 x 30	2	1	8	4,908	-	-	-	-	-	-	3,027	-	-	-
TFF-9036-PE	90 x 36	2	1	8	5,234	-	-	-	-	-	-	3,230	-	-	-
TFF-9042-PE	90 x 42	2	1	8	6,047	-	-	-	6,047	6,311	6,568	3,734	-	-	-
TFF-9048-PE	90 x 48	2	1	8	6,623	-	-	-	6,623	6,896	7,163	4,091	-	-	-
TFF-9630-PE	96 x 30	2	1	8	5,044	-	-	-	-	-	-	3,118	-	-	-
TFF-9636-PE	96 x 36	2	1	8	5,393	-	-	-	-	-	-	3,334	-	-	-
TFF-9642-PE	96 x 42	2	1	8	6,244	-	-	-	6,244	6,507	6,765	3,861	-	-	-
TFF-9648-PE	96 x 48	2	1	8	6,851	-	-	-	6,851	7,123	7,390	4,238	-	-	-
TFF-10242-PE	102 x 42	2	1	8	6,798	-	-	-	6,798	7,076	7,348	4,212	-	-	-
TFF-10248-PE	102 x 48	2	1	8	7,471	-	-	-	7,471	7,759	8,041	4,629	-	-	-
TFF-10842-PE	108 x 42	2	1	10	7,005	-	-	-	7,005	7,283	7,555	4,346	-	-	-
TFF-10848-PE	108 x 48	2	1	10	7,712	-	-	-	7,712	7,999	8,280	4,785	-	-	-
TFF-10854-PE	108 x 54	2	1	10	8,541	-	-	-	8,541	8,841	9,135	6,491	-	-	-
TFF-11442-PE	114 x 42	2	1	10	7,591	-	-	-	7,591	7,884	8,171	4,717	-	-	-
TFF-11448-PE	114 x 48	2	1	10	8,371	-	-	-	8,371	8,674	8,970	5,201	-	-	-
TFF-11454-PE	114 x 54	2	1	12	9,282	-	-	-	9,282	9,599	9,908	5,768	-	-	-
TFF-12042-PE	120 x 42	2	1	10	7,809	-	-	-	7,809	8,103	8,389	4,859	-	-	-
TFF-12048-PE	120 x 48	2	1	10	8,624	-	-	-	8,624	8,926	9,223	5,365	-	-	-
TFF-12054-PE	120 x 54	2	1	12	9,575	-	-	-	9,575	9,891	10,200	5,956	-	-	-
TFF-13242-PE	132 x 42	2	2	10	8,590	-	-	-	8,590	8,894	9,192	5,358	-	-	-
TFF-13248-PE	132 x 48	2	2	10	9,510	-	-	-	9,510	9,826	10,134	5,931	-	-	-
TFF-13254-PE	132 x 54	2	2	12	10,584	-	-	-	10,584	10,914	11,236	6,598	-	-	-
TFF-14448-PE	144 x 48	2	2	12	10,438	-	-	-	10,438	10,766	11,087	6,523	-	-	-
TFF-14454-PE	144 x 54	2	2	14	11,641	-	-	-	11,641	11,985	12,320	7,272	-	-	-
TFF-14460-PE	144 x 60	2	2	14	13,039	-	-	-	13,039	13,400	13,753	8,142	-	-	-
TFF-15648-PE	156 x 48	3	2	14	-	13,309	13,309	13,309	13,309	13,806	14,292	-	8,332	8,332	8,332
TFF-15654-PE	156 x 54	3	2	14	-	14,710	14,710	14,710	14,710	15,230	15,737	-	9,205	9,205	9,205
TFF-15660-PE	156 x 60	3	2	14	-	16,344	16,344	16,344	16,344	16,892	17,426	-	10,223	10,223	10,223
TFF-16854-PE	168 x 54	3	2	16	-	15,431	15,431	15,431	15,431	15,951	16,458	-	9,684	9,684	9,684
TFF-16860-PE	168 x 60	3	2	16	-	17,170	17,170	17,170	17,170	17,716	18,251	-	10,769	10,769	10,769
TFF-18054-PE	180 x 54	3	2	16	-	16,152	16,152	16,152	16,152	16,672	17,179	-	10,163	10,163	10,163
TFF-18060-PE	180 x 60	3	2	16	-	17,994	17,994	17,994	17,994	18,542	19,076	-	11,315	11,315	11,315
TFF-19254-PE	192 x 54	3	2	18	-	16,873	16,873	16,873	16,873	17,392	17,901	-	10,643	10,643	10,643
TFF-19260-PE	192 x 60	3	2	18	-	18,819	18,819	18,819	18,819	19,366	19,901	-	11,860	11,860	11,860
TFF-20454-PE	204 x 54	3	2	18	-	18,308	18,308	18,308	18,308	18,848	19,377	-	11,574	11,574	11,574
TFF-20460-PE	204 x 60	3	2	18	-	20,441	20,441	20,441	20,441	21,011	21,567	-	12,910	12,910	12,910
TFF-21654-PE	216 x 54	3	2	20	-	19,523	19,523	19,523	19,523	20,077	20,618	-	12,366	12,366	12,366
TFF-21660-PE	216 x 60	3	2	20	-	21,820	21,820	21,820	21,820	22,403	22,973	-	13,806	13,806	13,806
TFF-22854-PE	228 x 54	3	2	20	-	20,485	20,485	20,485	20,485	21,045	21,590	-	13,000	13,000	13,000
TFF-22860-PE	228 x 60	3	2	20	-	22,915	22,915	22,915	22,915	23,504	24,079	-	14,525	14,525	14,525
TFF-24054-PE	240 x 54	3	2	20	-	21,502	21,502	21,502	21,502	22,067	22,620	-	13,669	13,669	13,669
TFF-24060-PE	240 x 60	3	2	20	-	24,072	24,072	24,072	24,072	24,667	25,249	-	15,282	15,282	15,282



LAMINATE TOP WITH SQUARE EDGE

OPTIONS	CODE	PRICE	NOTES
Power & Data Options			See pages 112-122
Polished Chrome Finish Options:			
Polished Chrome Open Frame Base	Add -PCOF-TWB	\$2,392	
Polished Chrome Post Metal Legs	Add -PCML-TWB	\$1,284	
Polished Chrome Open Frame with X-Center Base	Add -PCOFX-TWB	\$3,586	
Polished Chrome Post Metal Legs with X-Center Base	Add -PCMLX-TWB	\$2,478	
Multi-Section Tops:			
102", 108", 114" and 120" one-piece tops split into two sections	Specify -2	\$843	Note: Power Matrix (center of table location only) cannot be specified when this option is selected
204", 216", 228" or 240" two-piece tops split into four sections	Specify -4	\$1,681	

EDGE PROFILE



Two4Six Square Edge

GENERAL INFORMATION

- Tops are 1-1/8"-thick
- Seating capacity based on 27" per person
- Overall table height 29.5"
- Standard with quarter cut veneer
- One section of wire management channel provided per table with Post Metal Leg and Open Frame Square Bases
- Racetrack Bases have a removable access door

REQUIRED INFORMATION (ORDER CANNOT BE ENTERED WITHOUT THIS INFORMATION)

See appendix pages vi-viii for surface material options.

- Choose Laminate Finish
- Choose Solid Edge Band Finish or Coordinating Woodgrain Edge Band Finish
- Choose Metal Finish only if -OF or -ML bases specified (Clear Anodized (-CA) is an option on the Post Metal Leg only)
- Choose Beam Metal Finish for tables 102"-240"L, with a Racetrack Base (-RCL, -RCP, -RCV)



GLASS TOP



RECTANGLE TOP

BASE KEY

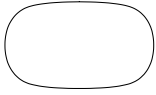
- OF Open Frame
- OFX Open Frame with X Center Base
- OFRP Open Frame with Painted Rectangle Center Base
- OFRV Open Frame with Veneer Rectangle Center Base
- RCL Laminate Racetrack Base
- RCP Painted Racetrack Base
- RCV Veneer Racetrack Base

RECTANGLE TABLES

MODEL #	L x W	BASE QTY	GLASS SECTIONS	SEATING CAPACITY	-OF	-OFX	-OFRP	-OFRV	-RCL	-RCP	-RCV
TFT-6030-G	60 x 30	2	1	4	6,524	-	-	-	-	-	-
TFT-6036-G	60 x 36	2	1	4	6,860	-	-	-	-	-	-
TFT-6042-G	60 x 42	2	1	4	7,827	-	-	-	-	-	-
TFT-6048-G	60 x 48	2	1	4	8,474	-	-	-	-	-	-
TFT-6630-G	66 x 30	2	1	4	7,111	-	-	-	-	-	-
TFT-6636-G	66 x 36	2	1	4	7,501	-	-	-	-	-	-
TFT-6642-G	66 x 42	2	1	4	8,582	-	-	-	-	-	-
TFT-6648-G	66 x 48	2	1	4	9,318	-	-	-	-	-	-
TFT-7230-G	72 x 30	2	1	6	7,334	-	-	-	-	-	-
TFT-7236-G	72 x 36	2	1	6	7,760	-	-	-	-	-	-
TFT-7242-G	72 x 42	2	1	6	8,903	-	-	-	8,903	9,334	9,754
TFT-7248-G	72 x 48	2	1	6	9,690	-	-	-	9,690	10,136	10,569
TFT-7830-G	78 x 30	2	1	6	8,083	-	-	-	-	-	-
TFT-7836-G	78 x 36	2	1	6	8,576	-	-	-	-	-	-
TFT-7842-G	78 x 42	2	1	6	9,864	-	-	-	9,864	10,325	10,774
TFT-7848-G	78 x 48	2	1	6	10,761	-	-	-	10,761	11,236	11,700
TFT-8430-G	84 x 30	2	1	8	8,323	-	-	-	-	-	-
TFT-8436-G	84 x 36	2	1	8	8,855	-	-	-	-	-	-
TFT-8442-G	84 x 42	2	1	8	10,206	-	-	-	10,206	10,666	11,115
TFT-8448-G	84 x 48	2	1	8	11,158	-	-	-	11,158	11,633	12,098
TFT-9030-G	90 x 30	2	1	8	9,006	-	-	-	-	-	-
TFT-9036-G	90 x 36	2	1	8	9,605	-	-	-	-	-	-
TFT-9042-G	90 x 42	2	1	8	11,098	-	-	-	11,098	11,582	12,055
TFT-9048-G	90 x 48	2	1	8	12,154	-	-	-	12,154	12,655	13,145
TFT-9630-G	96 x 30	2	1	8	9,258	-	-	-	-	-	-
TFT-9636-G	96 x 36	2	1	8	9,897	-	-	-	-	-	-
TFT-9642-G	96 x 42	2	1	8	11,459	-	-	-	11,459	11,942	12,415
TFT-9648-G	96 x 48	2	1	8	12,573	-	-	-	12,573	13,072	13,562
TFT-10242-G	102 x 42	2	2	8	12,476	-	-	-	12,476	12,986	13,485
TFT-10248-G	102 x 48	2	2	8	13,711	-	-	-	13,711	14,240	14,757
TFT-10842-G	108 x 42	2	2	10	12,856	-	-	-	12,856	13,367	13,866
TFT-10848-G	108 x 48	2	2	10	14,153	-	-	-	14,153	14,680	15,196
TFT-10854-G	108 x 54	2	2	10	15,675	-	-	-	15,675	16,226	16,766
TFT-11442-G	114 x 42	2	2	10	13,931	-	-	-	13,931	14,469	14,995
TFT-11448-G	114 x 48	2	2	10	15,363	-	-	-	15,363	15,919	16,462
TFT-11454-G	114 x 54	2	2	12	17,036	-	-	-	17,036	17,616	18,184
TFT-12042-G	120 x 42	2	2	10	14,332	-	-	-	14,332	14,870	15,396
TFT-12048-G	120 x 48	2	2	10	15,827	-	-	-	15,827	16,382	16,926
TFT-12054-G	120 x 54	2	2	12	17,572	-	-	-	17,572	18,153	18,720
TFT-13242-G	132 x 42	2	3	10	15,764	-	-	-	15,764	16,323	16,870
TFT-13248-G	132 x 48	2	3	10	17,454	-	-	-	17,454	18,033	18,599
TFT-13254-G	132 x 54	2	3	12	19,424	-	-	-	19,424	20,029	20,621
TFT-14448-G	144 x 48	2	3	12	19,156	-	-	-	19,156	19,758	20,348
TFT-14454-G	144 x 54	2	3	14	21,365	-	-	-	21,365	21,995	22,610
TFT-14460-G	144 x 60	2	3	14	23,931	-	-	-	23,931	24,592	25,240
TFT-15648-G	156 x 48	3	3	14	-	24,425	24,425	24,425	24,425	25,338	26,230
TFT-15654-G	156 x 54	3	3	14	-	26,996	26,996	26,996	26,996	27,951	28,882
TFT-15660-G	156 x 60	3	3	14	-	29,996	29,996	29,996	29,996	31,001	31,982
TFT-16854-G	168 x 54	3	3	16	-	28,321	28,321	28,321	28,321	29,274	30,205
TFT-16860-G	168 x 60	3	3	16	-	31,511	31,511	31,511	31,511	32,514	33,495
TFT-18054-G	180 x 54	3	3	16	-	29,644	29,644	29,644	29,644	30,597	31,528
TFT-18060-G	180 x 60	3	3	16	-	33,024	33,024	33,024	33,024	34,029	35,010
TFT-19254-G	192 x 54	3	4	18	-	30,966	30,966	30,966	30,966	31,920	32,853
TFT-19260-G	192 x 60	3	4	18	-	34,537	34,537	34,537	34,537	35,542	36,523
TFT-20454-G	204 x 54	3	4	18	-	33,600	33,600	33,600	33,600	34,592	35,562
TFT-20460-G	204 x 60	3	4	18	-	37,515	37,515	37,515	37,515	38,561	39,581
TFT-21654-G	216 x 54	3	4	20	-	35,831	35,831	35,831	35,831	36,846	37,840
TFT-21660-G	216 x 60	3	4	20	-	40,046	40,046	40,046	40,046	41,116	42,161
TFT-22854-G	228 x 54	3	4	20	-	37,596	37,596	37,596	37,596	38,623	39,624
TFT-22860-G	228 x 60	3	4	20	-	42,055	42,055	42,055	42,055	43,136	44,192
TFT-24054-G	240 x 54	3	4	20	-	39,462	39,462	39,462	39,462	40,500	41,514
TFT-24060-G	240 x 60	3	4	20	-	44,178	44,178	44,178	44,178	45,272	46,339



GLASS TOP



SOFT RECTANGLE TOP

BASE KEY

- OF Open Frame
- OFX Open Frame with X Center Base
- OFRP Open Frame with Painted Rectangle Center Base
- OFRV Open Frame with Veneer Rectangle Center Base
- RCL Laminate Racetrack Base
- RCP Painted Racetrack Base
- RCV Veneer Racetrack Base

SOFT RECTANGLE TABLES

MODEL #	L x W	BASE QTY	GLASS SECTIONS	SEATING CAPACITY	-OF	-OFX	-OFRP	-OFRV	-RCL	-RCP	-RCV
TFF-6030-G	60 x 30	2	1	4	6,524	-	-	-	-	-	-
TFF-6036-G	60 x 36	2	1	4	6,860	-	-	-	-	-	-
TFF-6042-G	60 x 42	2	1	4	7,827	-	-	-	-	-	-
TFF-6048-G	60 x 48	2	1	4	8,474	-	-	-	-	-	-
TFF-6630-G	66 x 30	2	1	4	7,111	-	-	-	-	-	-
TFF-6636-G	66 x 36	2	1	4	7,501	-	-	-	-	-	-
TFF-6642-G	66 x 42	2	1	4	8,582	-	-	-	-	-	-
TFF-6648-G	66 x 48	2	1	4	9,318	-	-	-	-	-	-
TFF-7230-G	72 x 30	2	1	6	7,334	-	-	-	-	-	-
TFF-7236-G	72 x 36	2	1	6	7,760	-	-	-	-	-	-
TFF-7242-G	72 x 42	2	1	6	8,903	-	-	-	8,903	9,334	9,754
TFF-7248-G	72 x 48	2	1	6	9,690	-	-	-	9,690	10,136	10,569
TFF-7830-G	78 x 30	2	1	6	8,083	-	-	-	-	-	-
TFF-7836-G	78 x 36	2	1	6	8,576	-	-	-	-	-	-
TFF-7842-G	78 x 42	2	1	6	9,864	-	-	-	9,864	10,325	10,774
TFF-7848-G	78 x 48	2	1	6	10,761	-	-	-	10,761	11,236	11,700
TFF-8430-G	84 x 30	2	1	8	8,323	-	-	-	-	-	-
TFF-8436-G	84 x 36	2	1	8	8,855	-	-	-	-	-	-
TFF-8442-G	84 x 42	2	1	8	10,206	-	-	-	10,206	10,666	11,115
TFF-8448-G	84 x 48	2	1	8	11,158	-	-	-	11,158	11,633	12,098
TFF-9030-G	90 x 30	2	1	8	9,006	-	-	-	-	-	-
TFF-9036-G	90 x 36	2	1	8	9,605	-	-	-	-	-	-
TFF-9042-G	90 x 42	2	1	8	11,098	-	-	-	11,098	11,582	12,055
TFF-9048-G	90 x 48	2	1	8	12,154	-	-	-	12,154	12,655	13,145
TFF-9630-G	96 x 30	2	1	8	9,258	-	-	-	-	-	-
TFF-9636-G	96 x 36	2	1	8	9,897	-	-	-	-	-	-
TFF-9642-G	96 x 42	2	1	8	11,459	-	-	-	11,459	11,942	12,415
TFF-9648-G	96 x 48	2	1	8	12,573	-	-	-	12,573	13,072	13,562
TFF-10242-G	102 x 42	2	2	8	12,476	-	-	-	12,476	12,986	13,485
TFF-10248-G	102 x 48	2	2	8	13,711	-	-	-	13,711	14,240	14,757
TFF-10842-G	108 x 42	2	2	10	12,856	-	-	-	12,856	13,367	13,866
TFF-10848-G	108 x 48	2	2	10	14,153	-	-	-	14,153	14,680	15,196
TFF-10854-G	108 x 54	2	2	10	15,675	-	-	-	15,675	16,226	16,766
TFF-11442-G	114 x 42	2	2	10	13,931	-	-	-	13,931	14,469	14,995
TFF-11448-G	114 x 48	2	2	10	15,363	-	-	-	15,363	15,919	16,462
TFF-11454-G	114 x 54	2	2	12	17,036	-	-	-	17,036	17,616	18,184
TFF-12042-G	120 x 42	2	2	10	14,332	-	-	-	14,332	14,870	15,396
TFF-12048-G	120 x 48	2	2	10	15,827	-	-	-	15,827	16,382	16,926
TFF-12054-G	120 x 54	2	2	12	17,572	-	-	-	17,572	18,153	18,720
TFF-13242-G	132 x 42	2	3	10	15,764	-	-	-	15,764	16,323	16,870
TFF-13248-G	132 x 48	2	3	10	17,454	-	-	-	17,454	18,033	18,599
TFF-13254-G	132 x 54	2	3	12	19,424	-	-	-	19,424	20,029	20,621
TFF-14448-G	144 x 48	2	3	12	19,156	-	-	-	19,156	19,758	20,348
TFF-14454-G	144 x 54	2	2	14	21,365	-	-	-	21,365	21,995	22,610
TFF-14460-G	144 x 60	2	3	14	23,931	-	-	-	23,931	24,592	25,240
TFF-15648-G	156 x 48	3	3	14	-	24,425	24,425	24,425	24,425	25,338	26,230
TFF-15654-G	156 x 54	3	3	14	-	26,996	26,996	26,996	26,996	27,951	28,882
TFF-15660-G	156 x 60	3	3	14	-	29,996	29,996	29,996	29,996	31,001	31,982
TFF-16854-G	168 x 54	3	3	16	-	28,321	28,321	28,321	28,321	29,274	30,205
TFF-16860-G	168 x 60	3	3	16	-	31,511	31,511	31,511	31,511	32,514	33,495
TFF-18054-G	180 x 54	3	3	16	-	29,644	29,644	29,644	29,644	30,597	31,528
TFF-18060-G	180 x 60	3	3	16	-	33,024	33,024	33,024	33,024	34,029	35,010
TFF-19254-G	192 x 54	3	4	18	-	30,966	30,966	30,966	30,966	31,920	32,853
TFF-19260-G	192 x 60	3	4	18	-	34,537	34,537	34,537	34,537	35,542	36,523
TFF-20454-G	204 x 54	3	4	18	-	33,600	33,600	33,600	33,600	34,592	35,562
TFF-20460-G	204 x 60	3	4	18	-	37,515	37,515	37,515	37,515	38,561	39,581
TFF-21654-G	216 x 54	3	4	20	-	35,831	35,831	35,831	35,831	36,846	37,840
TFF-21660-G	216 x 60	3	4	20	-	40,046	40,046	40,046	40,046	41,116	42,161
TFF-22854-G	228 x 54	3	4	20	-	37,596	37,596	37,596	37,596	38,623	39,624
TFF-22860-G	228 x 60	3	4	20	-	42,055	42,055	42,055	42,055	43,136	44,192
TFF-24054-G	240 x 54	3	4	20	-	39,462	39,462	39,462	39,462	40,500	41,514
TFF-24060-G	240 x 60	3	4	20	-	44,178	44,178	44,178	44,178	45,272	46,339



GLASS TOP

OPTIONS	CODE	PRICE	NOTES
Power & Data Options			See pages 112-122
Polished Chrome Finish Options:			
Polished Chrome Open Frame Base	Add -PCOF-TWB	\$2,392	
Polished Chrome Open Frame with X-Center Base	Add -PCOFX-TWB	\$3,586	
Satin Glass Options:			
60"-96" Tables	Add -TFSG	\$685	
102"-132" Tables	Add -TFSG	\$912	
144"-180" Tables	Add -TFSG	\$1,142	
192"-228" Tables	Add -TFSG	\$1,467	
240" Tables	Add -TFSG	\$1,683	
Multi-Section Tops:			
102", 108", 114" and 120" one-piece tops split into two sections	Specify -2	\$843	Note: Power Matrix (center of table location only) cannot be specified when this option is selected
204", 216", 228" or 240" two-piece tops split into four sections	Specify -4	\$1,681	

EDGE PROFILE



Two4Six Glass Edge

GENERAL INFORMATION

- Tops are 1-1/8"-thick with 3/16"-thick hardwood edge band
- Seating capacity based on 27" per person
- Overall table height 29.5"
- One section of wire management channel provided per table with Post Metal Leg and Open Frame Square Bases
- Racetrack Bases have a removable access door

REQUIRED INFORMATION (ORDER CANNOT BE ENTERED WITHOUT THIS INFORMATION)

See appendix pages vi-viii for surface material options.

- Choose Glass Finish
- Choose Veneer Finish, if applicable
- Choose Metal Finish, if applicable
- Choose Paint Finish, if applicable
- Choose Sub-Top Finish: Paint Finish or Wood Species & Finish
- Choose Solid Edge Band Finish or Coordinating Woodgrain Edge Band Finish, if -RCL Base specified
- Choose Beam Metal Finish for tables 102"-240"L, with a Racetrack Base (-RCL, -RCP, -RCV)



SOLID SURFACE TOP



RECTANGLE TOP

BASE KEY

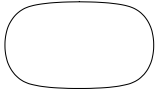
- OF Open Frame
- OFX Open Frame with X Center Base
- OFRP Open Frame with Painted Rectangle Center Base
- OFRV Open Frame with Veneer Rectangle Center Base
- RCL Laminate Racetrack Base
- RCP Painted Racetrack Base
- RCV Veneer Racetrack Base

RECTANGLE TABLES

MODEL #	L x W	BASE QTY	GLASS SECTIONS	SEATING CAPACITY	-OF	-OFX	-OFRP	-OFRV	-RCL	-RCP	-RCV
TFT-6030-SS	60 x 30	2	1	4	6,817	-	-	-	-	-	-
TFT-6036-SS	60 x 36	2	1	4	7,168	-	-	-	-	-	-
TFT-6042-SS	60 x 42	2	1	4	8,178	-	-	-	-	-	-
TFT-6048-SS	60 x 48	2	1	4	8,855	-	-	-	-	-	-
TFT-6630-SS	66 x 30	2	1	4	7,430	-	-	-	-	-	-
TFT-6636-SS	66 x 36	2	1	4	7,838	-	-	-	-	-	-
TFT-6642-SS	66 x 42	2	1	4	8,967	-	-	-	-	-	-
TFT-6648-SS	66 x 48	2	1	4	9,736	-	-	-	-	-	-
TFT-7230-SS	72 x 30	2	1	6	7,663	-	-	-	-	-	-
TFT-7236-SS	72 x 36	2	1	6	8,108	-	-	-	-	-	-
TFT-7242-SS	72 x 42	2	1	6	9,303	-	-	-	9,303	9,753	10,191
TFT-7248-SS	72 x 48	2	1	6	10,124	-	-	-	10,124	10,591	11,044
TFT-7830-SS	78 x 30	2	1	6	8,446	-	-	-	-	-	-
TFT-7836-SS	78 x 36	2	1	6	8,961	-	-	-	-	-	-
TFT-7842-SS	78 x 42	2	1	6	10,307	-	-	-	10,307	10,788	11,257
TFT-7848-SS	78 x 48	2	1	6	11,244	-	-	-	11,244	11,740	12,225
TFT-8430-SS	84 x 30	2	1	8	8,697	-	-	-	-	-	-
TFT-8436-SS	84 x 36	2	1	8	9,252	-	-	-	-	-	-
TFT-8442-SS	84 x 42	2	1	8	10,664	-	-	-	10,664	11,145	11,614
TFT-8448-SS	84 x 48	2	1	8	11,658	-	-	-	11,658	12,155	12,641
TFT-9030-SS	90 x 30	2	1	8	9,410	-	-	-	-	-	-
TFT-9036-SS	90 x 36	2	1	8	10,036	-	-	-	-	-	-
TFT-9042-SS	90 x 42	2	1	8	11,596	-	-	-	11,596	12,102	12,596
TFT-9048-SS	90 x 48	2	1	8	12,700	-	-	-	12,700	13,223	13,735
TFT-9630-SS	96 x 30	2	1	8	9,673	-	-	-	-	-	-
TFT-9636-SS	96 x 36	2	1	8	10,341	-	-	-	-	-	-
TFT-9642-SS	96 x 42	2	1	8	11,973	-	-	-	11,973	12,478	12,972
TFT-9648-SS	96 x 48	2	1	8	13,137	-	-	-	13,137	13,658	14,170
TFT-10242-SS	102 x 42	2	2	8	13,036	-	-	-	13,036	13,569	14,090
TFT-10248-SS	102 x 48	2	2	8	14,327	-	-	-	14,327	14,879	15,419
TFT-10842-SS	108 x 42	2	2	10	13,433	-	-	-	13,433	13,966	14,488
TFT-10848-SS	108 x 48	2	2	10	14,788	-	-	-	14,788	15,339	15,878
TFT-10854-SS	108 x 54	2	2	10	16,379	-	-	-	16,379	16,954	17,518
TFT-11442-SS	114 x 42	2	2	10	14,556	-	-	-	14,556	15,119	15,668
TFT-11448-SS	114 x 48	2	2	10	16,053	-	-	-	16,053	16,633	17,200
TFT-11454-SS	114 x 54	2	2	12	17,800	-	-	-	17,800	18,406	19,000
TFT-12042-SS	120 x 42	2	2	10	14,975	-	-	-	14,975	15,538	16,087
TFT-12048-SS	120 x 48	2	2	10	16,537	-	-	-	16,537	17,117	17,686
TFT-12054-SS	120 x 54	2	2	12	18,361	-	-	-	18,361	18,967	19,560
TFT-13242-SS	132 x 42	2	3	10	16,472	-	-	-	16,472	17,055	17,627
TFT-13248-SS	132 x 48	2	3	10	18,237	-	-	-	18,237	18,842	19,433
TFT-13254-SS	132 x 54	2	3	12	20,296	-	-	-	20,296	20,928	21,546
TFT-14448-SS	144 x 48	2	3	12	20,015	-	-	-	20,015	20,644	21,261
TFT-14454-SS	144 x 54	2	2	14	22,323	-	-	-	22,323	22,982	23,624
TFT-14460-SS	144 x 60	2	3	14	25,005	-	-	-	25,005	25,696	26,372
TFT-15648-SS	156 x 48	3	3	14	-	25,521	25,521	25,521	25,521	26,475	27,407
TFT-15654-SS	156 x 54	3	3	14	-	28,208	28,208	28,208	28,208	29,205	30,178
TFT-15660-SS	156 x 60	3	3	14	-	31,342	31,342	31,342	31,342	32,392	33,417
TFT-16854-SS	168 x 54	3	3	16	-	29,592	29,592	29,592	29,592	30,587	31,561
TFT-16860-SS	168 x 60	3	3	16	-	32,925	32,925	32,925	32,925	33,973	34,998
TFT-18054-SS	180 x 54	3	3	16	-	30,974	30,974	30,974	30,974	31,970	32,943
TFT-18060-SS	180 x 60	3	3	16	-	34,506	34,506	34,506	34,506	35,556	36,581
TFT-19254-SS	192 x 54	3	4	18	-	32,356	32,356	32,356	32,356	33,352	34,327
TFT-19260-SS	192 x 60	3	4	18	-	36,087	36,087	36,087	36,087	37,137	38,162
TFT-20454-SS	204 x 54	3	4	18	-	35,107	35,107	35,107	35,107	36,144	37,158
TFT-20460-SS	204 x 60	3	4	18	-	39,199	39,199	39,199	39,199	40,291	41,357
TFT-21654-SS	216 x 54	3	4	20	-	37,438	37,438	37,438	37,438	38,499	39,538
TFT-21660-SS	216 x 60	3	4	20	-	41,843	41,843	41,843	41,843	42,961	44,053
TFT-22854-SS	228 x 54	3	4	20	-	39,283	39,283	39,283	39,283	40,356	41,402
TFT-22860-SS	228 x 60	3	4	20	-	43,942	43,942	43,942	43,942	45,072	46,175
TFT-24054-SS	240 x 54	3	4	20	-	41,233	41,233	41,233	41,233	42,317	43,376
TFT-24060-SS	240 x 60	3	4	20	-	46,160	46,160	46,160	46,160	47,303	48,418



SOLID SURFACE TOP



SOFT RECTANGLE TOP

BASE KEY

- OF Open Frame
- OFX Open Frame with X Center Base
- OFRP Open Frame with Painted Rectangle Center Base
- OFRV Open Frame with Veneer Rectangle Center Base
- RCL Laminate Racetrack Base
- RCP Painted Racetrack Base
- RCV Veneer Racetrack Base

SOFT RECTANGLE TABLES

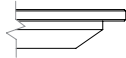
MODEL #	L x W	BASE QTY	GLASS SECTIONS	SEATING CAPACITY	-OF	-OFX	-OFRP	-OFRV	-RCL	-RCP	-RCV
TFF-6030-SS	60 x 30	2	1	4	6,817	-	-	-	-	-	-
TFF-6036-SS	60 x 36	2	1	4	7,168	-	-	-	-	-	-
TFF-6042-SS	60 x 42	2	1	4	8,178	-	-	-	-	-	-
TFF-6048-SS	60 x 48	2	1	4	8,855	-	-	-	-	-	-
TFF-6630-SS	66 x 30	2	1	4	7,430	-	-	-	-	-	-
TFF-6636-SS	66 x 36	2	1	4	7,838	-	-	-	-	-	-
TFF-6642-SS	66 x 42	2	1	4	8,967	-	-	-	-	-	-
TFF-6648-SS	66 x 48	2	1	4	9,736	-	-	-	-	-	-
TFF-7230-SS	72 x 30	2	1	6	7,663	-	-	-	-	-	-
TFF-7236-SS	72 x 36	2	1	6	8,108	-	-	-	-	-	-
TFF-7242-SS	72 x 42	2	1	6	9,303	-	-	-	9,303	9,753	10,191
TFF-7248-SS	72 x 48	2	1	6	10,124	-	-	-	10,124	10,591	11,044
TFF-7830-SS	78 x 30	2	1	6	8,446	-	-	-	-	-	-
TFF-7836-SS	78 x 36	2	1	6	8,961	-	-	-	-	-	-
TFF-7842-SS	78 x 42	2	1	6	10,307	-	-	-	10,307	10,788	11,257
TFF-7848-SS	78 x 48	2	1	6	11,244	-	-	-	11,244	11,740	12,225
TFF-8430-SS	84 x 30	2	1	8	8,697	-	-	-	-	-	-
TFF-8436-SS	84 x 36	2	1	8	9,252	-	-	-	-	-	-
TFF-8442-SS	84 x 42	2	1	8	10,664	-	-	-	10,664	11,145	11,614
TFF-8448-SS	84 x 48	2	1	8	11,658	-	-	-	11,658	12,155	12,641
TFF-9030-SS	90 x 30	2	1	8	9,410	-	-	-	-	-	-
TFF-9036-SS	90 x 36	2	1	8	10,036	-	-	-	-	-	-
TFF-9042-SS	90 x 42	2	1	8	11,596	-	-	-	11,596	12,102	12,596
TFF-9048-SS	90 x 48	2	1	8	12,700	-	-	-	12,700	13,223	13,735
TFF-9630-SS	96 x 30	2	1	8	9,673	-	-	-	-	-	-
TFF-9636-SS	96 x 36	2	1	8	10,341	-	-	-	-	-	-
TFF-9642-SS	96 x 42	2	1	8	11,973	-	-	-	11,973	12,478	12,972
TFF-9648-SS	96 x 48	2	1	8	13,137	-	-	-	13,137	13,658	14,170
TFF-10242-SS	102 x 42	2	2	8	13,036	-	-	-	13,036	13,569	14,090
TFF-10248-SS	102 x 48	2	2	8	14,327	-	-	-	14,327	14,879	15,419
TFF-10842-SS	108 x 42	2	2	10	13,433	-	-	-	13,433	13,966	14,488
TFF-10848-SS	108 x 48	2	2	10	14,788	-	-	-	14,788	15,339	15,878
TFF-10854-SS	108 x 54	2	2	10	16,379	-	-	-	16,379	16,954	17,518
TFF-11442-SS	114 x 42	2	2	10	14,556	-	-	-	14,556	15,119	15,668
TFF-11448-SS	114 x 48	2	2	10	16,053	-	-	-	16,053	16,633	17,200
TFF-11454-SS	114 x 54	2	2	12	17,800	-	-	-	17,800	18,406	19,000
TFF-12042-SS	120 x 42	2	2	10	14,975	-	-	-	14,975	15,538	16,087
TFF-12048-SS	120 x 48	2	2	10	16,537	-	-	-	16,537	17,117	17,686
TFF-12054-SS	120 x 54	2	2	12	18,361	-	-	-	18,361	18,967	19,560
TFF-13242-SS	132 x 42	2	3	10	16,472	-	-	-	16,472	17,055	17,627
TFF-13248-SS	132 x 48	2	3	10	18,237	-	-	-	18,237	18,842	19,433
TFF-13254-SS	132 x 54	2	3	12	20,296	-	-	-	20,296	20,928	21,546
TFF-14448-SS	144 x 48	2	3	12	20,015	-	-	-	20,015	20,644	21,261
TFF-14454-SS	144 x 54	2	2	14	22,323	-	-	-	22,323	22,982	23,624
TFF-14460-SS	144 x 60	2	3	14	25,005	-	-	-	25,005	25,696	26,372
TFF-15648-SS	156 x 48	3	3	14	-	25,521	25,521	25,521	25,521	26,475	27,407
TFF-15654-SS	156 x 54	3	3	14	-	28,208	28,208	28,208	28,208	29,205	30,178
TFF-15660-SS	156 x 60	3	3	14	-	31,342	31,342	31,342	31,342	32,392	33,417
TFF-16854-SS	168 x 54	3	3	16	-	29,592	29,592	29,592	29,592	30,587	31,561
TFF-16860-SS	168 x 60	3	3	16	-	32,925	32,925	32,925	32,925	33,973	34,998
TFF-18054-SS	180 x 54	3	3	16	-	30,974	30,974	30,974	30,974	31,970	32,943
TFF-18060-SS	180 x 60	3	3	16	-	34,506	34,506	34,506	34,506	35,556	36,581
TFF-19254-SS	192 x 54	3	4	18	-	32,356	32,356	32,356	32,356	33,352	34,327
TFF-19260-SS	192 x 60	3	4	18	-	36,087	36,087	36,087	36,087	37,137	38,162
TFF-20454-SS	204 x 54	3	4	18	-	35,107	35,107	35,107	35,107	36,144	37,158
TFF-20460-SS	204 x 60	3	4	18	-	39,199	39,199	39,199	39,199	40,291	41,357
TFF-21654-SS	216 x 54	3	4	20	-	37,438	37,438	37,438	37,438	38,499	39,538
TFF-21660-SS	216 x 60	3	4	20	-	41,843	41,843	41,843	41,843	42,961	44,053
TFF-22854-SS	228 x 54	3	4	20	-	39,283	39,283	39,283	39,283	40,356	41,402
TFF-22860-SS	228 x 60	3	4	20	-	43,942	43,942	43,942	43,942	45,072	46,175
TFF-24054-SS	240 x 54	3	4	20	-	41,233	41,233	41,233	41,233	42,317	43,376
TFF-24060-SS	240 x 60	3	4	20	-	46,160	46,160	46,160	46,160	47,303	48,418



SOLID SURFACE TOP

OPTIONS	CODE	PRICE	NOTES
Power & Data Options			See pages 112-122
Polished Chrome Finish Options:			
Polished Chrome Open Frame Base	Add -PCOF-TWB	\$2,392	
Polished Chrome Open Frame with X-Center Base	Add -PCOFX-TWB	\$3,586	
Multi-Section Tops:			
102", 108", 114" and 120" one-piece tops split into two sections	Specify -2	\$843	Note: Power Matrix (center of table location only) cannot be specified when this option is selected
204", 216", 228" or 240" two-piece tops split into four sections	Specify -4	\$1,681	

EDGE PROFILE



Two4Six Solid Surface Edge

GENERAL INFORMATION

- Seating capacity based on 27" per person
- Overall table height 29.5"
- One section of wire management channel provided per table with Post Metal Leg and Open Frame Square Bases
- Racetrack Bases have a removable access door

REQUIRED INFORMATION (ORDER CANNOT BE ENTERED WITHOUT THIS INFORMATION)

See appendix pages vi-viii for surface material options.

- Choose Solid Surface Finish
- Choose Metal Finish
- Choose Solid Edge Band Finish or Coordinating Woodgrain Edge Band Finish, if -RCL Base specified
- Choose Beam Metal Finish for tables 102"-240"L, with a Racetrack Base (-RCL, -RCP, -RCV)



VENEER TOP WITH HARDWOOD EDGE / VENEER CASE



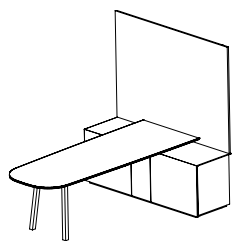
D-SHAPE TOP

BASE KEY

OF	Open Frame	RCL	Laminate Racetrack Base
ML	Post Metal Leg	RCP	Painted Racetrack Base
		RCV	Veneer Racetrack Base

D-SHAPE TOP // 60" CREDENZA BASE // SEATED HEIGHT

MODEL #	LENGTH	WIDTH	HEIGHT	CREDENZA BASE	SEATING CAPACITY	-OF	-ML	-RCL	-RCP	-RCV
TFL-3060-V	60	30	29-1/2	60	3	9,483	9,483	-	-	-
TFL-3660-V	60	36	29-1/2	60	3	9,698	9,698	-	-	-
TFL-4260-V	60	42	29-1/2	60	3	10,781	10,781	-	-	-
TFL-4860-V	60	48	29-1/2	60	3	11,395	11,395	-	-	-
TFL-3066-V	66	30	29-1/2	60	3	10,154	10,154	-	-	-
TFL-3666-V	66	36	29-1/2	60	3	10,404	10,404	-	-	-
TFL-4266-V	66	42	29-1/2	60	3	11,587	11,587	-	-	-
TFL-4866-V	66	48	29-1/2	60	3	12,269	12,269	-	-	-
TFL-3072-V	72	30	29-1/2	60	3	10,297	10,297	-	-	-
TFL-3672-V	72	36	29-1/2	60	3	10,570	10,570	-	-	-
TFL-4272-V	72	42	29-1/2	60	3	11,793	11,793	11,793	12,369	12,980
TFL-4872-V	72	48	29-1/2	60	3	12,507	12,507	12,507	13,103	13,735
TFL-3078-V	78	30	29-1/2	60	5	11,166	11,166	-	-	-
TFL-3678-V	78	36	29-1/2	60	5	11,482	11,482	-	-	-
TFL-4278-V	78	42	29-1/2	60	5	12,831	12,831	12,831	13,448	14,101
TFL-4878-V	78	48	29-1/2	60	5	13,630	13,630	13,630	14,268	14,943
TFL-3084-V	84	30	29-1/2	60	5	11,319	11,319	-	-	-
TFL-3684-V	84	36	29-1/2	60	5	11,660	11,660	-	-	-
TFL-4284-V	84	42	29-1/2	60	5	13,051	13,051	13,051	13,667	14,320
TFL-4884-V	84	48	29-1/2	60	5	13,884	13,884	13,884	14,522	15,198
TFL-3090-V	90	30	29-1/2	60	5	12,068	12,068	-	-	-
TFL-3690-V	90	36	29-1/2	60	5	12,452	12,452	-	-	-
TFL-4290-V	90	42	29-1/2	60	5	13,960	13,960	13,960	14,608	15,295
TFL-4890-V	90	48	29-1/2	60	5	14,874	14,874	14,874	15,544	16,255
TFL-3096-V	96	30	29-1/2	60	5	12,229	12,229	-	-	-
TFL-3696-V	96	36	29-1/2	60	5	12,639	12,639	-	-	-
TFL-4296-V	96	42	29-1/2	60	5	14,191	14,191	14,191	14,839	15,526
TFL-4896-V	96	48	29-1/2	60	5	15,141	15,141	15,141	15,812	16,522



Shown with optional Monitor Panel (-MP)

OPTIONS

Power & Data Options

See pages 112-122

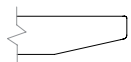
Polished Chrome Finish Options:

Polished Chrome Open Frame Base	Add -PCOF-TWA	\$1,357
Polished Chrome Post Metal Legs	Add -PCML-TWA	\$626

Credenza Base Options:

60"-wide Monitor Panel	Add -MP	\$2,881
Pull-out Waste/Recycling Unit (Left End Opening)	Add -TE	\$508
Locks	Add -L	\$257

EDGE PROFILE



Two4Six Cutback Edge

GENERAL INFORMATION

- Tops are 1-1/8"-thick with 3/16"-thick hardwood edge band
- Seating capacity based on 27" per person
- Overall table height 29.5", Overall height 78" if Monitor Panel is specified.
- Standard with quarter cut veneer
- Pull-Out Waste/Recycling option is located on left side of unit if specified
- Adjustable shelves standard
- Access door on the credenza base standard with a lock. All doors will be keyed alike if locks are specified.
- Credenza base is 22"-deep, the Monitor Panel adds 2" making the depth 24"
- Plinth base is veneer and recessed 1" on all sides
- One section of wire management channel provided per table with Post Metal Leg and Open Frame Bases
- Pull-Out Waste/Recycling Bin size: 14" x 10-1/2" x 18"
- Only Woodgrain Laminate options are available for the Racetrack Base
- Racetrack Bases have a removable access door

REQUIRED INFORMATION (ORDER CANNOT BE ENTERED WITHOUT THIS INFORMATION)

See appendix pages vi-viii for surface material options.

- Choose Veneer Finish
- Choose Solid Edge Band Finish or Coordinating Woodgrain Edge Band Finish, if -RCL Base specified
- Choose Metal Finish, if -OF or -ML Base is specified (Clear Anodized (-CA) is an option on the Post Metal Leg only)



INSET LAMINATE TOP WITH HARDWOOD EDGE / VENEER CASE



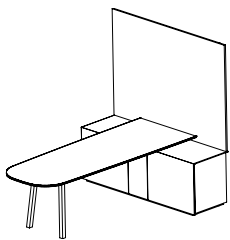
D-SHAPE TOP

BASE KEY

OF	Open Frame	RCL	Laminate Racetrack Base
ML	Post Metal Leg	RCP	Painted Racetrack Base
		RCV	Veneer Racetrack Base

D-SHAPE TOP // 60" CREDENZA BASE // SEATED HEIGHT

MODEL #	LENGTH	WIDTH	HEIGHT	CREDENZA BASE	SEATING CAPACITY	-OF	-ML	-RCL	-RCP	-RCV
TFL-3060-P	60	30	29-1/2	60	3	8,962	8,962	-	-	-
TFL-3660-P	60	36	29-1/2	60	3	9,165	9,165	-	-	-
TFL-4260-P	60	42	29-1/2	60	3	10,189	10,189	-	-	-
TFL-4860-P	60	48	29-1/2	60	3	10,769	10,769	-	-	-
TFL-3066-P	66	30	29-1/2	60	3	9,596	9,596	-	-	-
TFL-3666-P	66	36	29-1/2	60	3	9,832	9,832	-	-	-
TFL-4266-P	66	42	29-1/2	60	3	10,950	10,950	-	-	-
TFL-4866-P	66	48	29-1/2	60	3	11,595	11,595	-	-	-
TFL-3072-P	72	30	29-1/2	60	3	9,731	9,731	-	-	-
TFL-3672-P	72	36	29-1/2	60	3	9,989	9,989	-	-	-
TFL-4272-P	72	42	29-1/2	60	3	11,145	11,145	11,145	11,689	12,267
TFL-4872-P	72	48	29-1/2	60	3	11,820	11,820	11,820	12,383	12,980
TFL-3078-P	78	30	29-1/2	60	5	10,552	10,552	-	-	-
TFL-3678-P	78	36	29-1/2	60	5	10,851	10,851	-	-	-
TFL-4278-P	78	42	29-1/2	60	5	12,126	12,126	12,126	12,709	13,326
TFL-4878-P	78	48	29-1/2	60	5	12,881	12,881	12,881	13,484	14,122
TFL-3084-P	84	30	29-1/2	60	5	10,697	10,697	-	-	-
TFL-3684-P	84	36	29-1/2	60	5	11,019	11,019	-	-	-
TFL-4284-P	84	42	29-1/2	60	5	12,334	12,334	12,334	12,916	13,533
TFL-4884-P	84	48	29-1/2	60	5	13,121	13,121	13,121	13,724	14,363
TFL-3090-P	90	30	29-1/2	60	5	11,405	11,405	-	-	-
TFL-3690-P	90	36	29-1/2	60	5	11,768	11,768	-	-	-
TFL-4290-P	90	42	29-1/2	60	5	13,193	13,193	13,193	13,805	14,454
TFL-4890-P	90	48	29-1/2	60	5	14,056	14,056	14,056	14,690	15,361
TFL-3096-P	96	30	29-1/2	60	5	11,557	11,557	-	-	-
TFL-3696-P	96	36	29-1/2	60	5	11,944	11,944	-	-	-
TFL-4296-P	96	42	29-1/2	60	5	13,411	13,411	13,411	14,023	14,673
TFL-4896-P	96	48	29-1/2	60	5	14,309	14,309	14,309	14,943	15,614



Shown with optional Monitor Panel (-MP)

OPTIONS

Power & Data Options

See pages 112-122

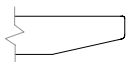
Polished Chrome Finish Options:

Polished Chrome Open Frame Base	Add -PCOF-TWA	\$1,357
Polished Chrome Post Metal Legs	Add -PCML-TWA	\$626

Credenza Base Options:

60"-wide Monitor Panel	Add -MP	\$2,881
Pull-out Waste/Recycling Unit (Left End Opening)	Add -TE	\$508
Locks	Add -L	\$257

EDGE PROFILE



Two4Six Cutback Edge

GENERAL INFORMATION

- Tops are 1-1/8"-thick with 3/16"-thick hardwood edge band
- Seating capacity based on 27" per person
- Overall table height 29.5", Overall height 78" if Monitor Panel is specified.
- Standard with quarter cut veneer
- Pull-Out Waste/Recycling option is located on left side of unit if specified
- Adjustable shelves standard
- Access door on the credenza base standard with a lock. All doors will be keyed alike if locks are specified.
- Credenza base is 22"-deep, the Monitor Panel adds 2" making the depth 24"
- Plinth base is veneer and recessed 1" on all sides
- One section of wire management channel provided per table with Post Metal Leg and Open Frame Bases
- Pull-Out Waste/Recycling Bin size: 14" x 10-1/2" x 18"
- Only Woodgrain Laminate options are available for the Racetrack Base
- Racetrack Bases have a removable access door

REQUIRED INFORMATION (ORDER CANNOT BE ENTERED WITHOUT THIS INFORMATION)

See appendix pages vi-viii for surface material options.

- Choose Laminate Finish
- Choose Wood Species & Finish for Hardwood Edge
- Choose Veneer Finish
- Choose Metal Finish, if -OF or -ML Base is specified (Clear Anodized (-CA) is an option on the Post Metal Leg only)
- Choose Solid Edge Band Finish or Coordinating Woodgrain Edge Band Finish, if -RCL Base specified



LAMINATE TOP WITH CUTBACK EDGE / VENEER CASE



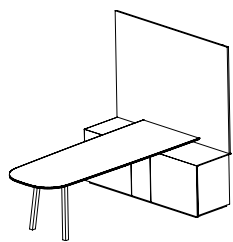
D-SHAPE TOP

BASE KEY

OF	Open Frame	RCL	Laminate Racetrack Base
ML	Post Metal Leg	RCP	Painted Racetrack Base
		RCV	Veneer Racetrack Base

D-SHAPE TOP // 60" CREDENZA BASE // SEATED HEIGHT

MODEL #	LENGTH	WIDTH	HEIGHT	CREDENZA BASE	SEATING CAPACITY	-OF	-ML	-RCL	-RCP	-RCV
TFL-3060-PA	60	30	29-1/2	60	3	8,962	8,962	-	-	-
TFL-3660-PA	60	36	29-1/2	60	3	9,165	9,165	-	-	-
TFL-4260-PA	60	42	29-1/2	60	3	10,189	10,189	-	-	-
TFL-4860-PA	60	48	29-1/2	60	3	10,769	10,769	-	-	-
TFL-3066-PA	66	30	29-1/2	60	3	9,596	9,596	-	-	-
TFL-3666-PA	66	36	29-1/2	60	3	9,832	9,832	-	-	-
TFL-4266-PA	66	42	29-1/2	60	3	10,950	10,950	-	-	-
TFL-4866-PA	66	48	29-1/2	60	3	11,595	11,595	-	-	-
TFL-3072-PA	72	30	29-1/2	60	3	9,731	9,731	-	-	-
TFL-3672-PA	72	36	29-1/2	60	3	9,989	9,989	-	-	-
TFL-4272-PA	72	42	29-1/2	60	3	11,145	11,145	11,145	11,689	12,267
TFL-4872-PA	72	48	29-1/2	60	3	11,820	11,820	11,820	12,383	12,980
TFL-3078-PA	78	30	29-1/2	60	5	10,552	10,552	-	-	-
TFL-3678-PA	78	36	29-1/2	60	5	10,851	10,851	-	-	-
TFL-4278-PA	78	42	29-1/2	60	5	12,126	12,126	12,126	12,709	13,326
TFL-4878-PA	78	48	29-1/2	60	5	12,881	12,881	12,881	13,484	14,122
TFL-3084-PA	84	30	29-1/2	60	5	10,697	10,697	-	-	-
TFL-3684-PA	84	36	29-1/2	60	5	11,019	11,019	-	-	-
TFL-4284-PA	84	42	29-1/2	60	5	12,334	12,334	12,334	12,916	13,533
TFL-4884-PA	84	48	29-1/2	60	5	13,121	13,121	13,121	13,724	14,363
TFL-3090-PA	90	30	29-1/2	60	5	11,405	11,405	-	-	-
TFL-3690-PA	90	36	29-1/2	60	5	11,768	11,768	-	-	-
TFL-4290-PA	90	42	29-1/2	60	5	13,193	13,193	13,193	13,805	14,454
TFL-4890-PA	90	48	29-1/2	60	5	14,056	14,056	14,056	14,690	15,361
TFL-3096-PA	96	30	29-1/2	60	5	11,557	11,557	-	-	-
TFL-3696-PA	96	36	29-1/2	60	5	11,944	11,944	-	-	-
TFL-4296-PA	96	42	29-1/2	60	5	13,411	13,411	13,411	14,023	14,673
TFL-4896-PA	96	48	29-1/2	60	5	14,309	14,309	14,309	14,943	15,614



Shown with optional Monitor Panel (-MP)

OPTIONS

Power & Data Options

See pages 112-122

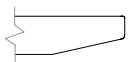
Polished Chrome Finish Options:

Polished Chrome Open Frame Base	Add -PCOF-TWA	\$1,357
Polished Chrome Post Metal Legs	Add -PCML-TWA	\$626

Credenza Base Options:

60"-wide Monitor Panel	Add -MP	\$2,881
Pull-out Waste/Recycling Unit (Left End Opening)	Add -TE	\$508
Locks	Add -L	\$257

EDGE PROFILE



Two4Six Cutback Edge

GENERAL INFORMATION

- Tops are 1-1/8"-thick
- Seating capacity based on 27" per person
- Overall table height 29.5", Overall height 78" if Monitor Panel is specified.
- Standard with quarter cut veneer
- Pull-Out Waste/Recycling option is located on left side of unit if specified
- Adjustable shelves standard
- Access door on the credenza base standard with a lock. All doors will be keyed alike if locks are specified.
- Credenza base is 22"-deep, the Monitor Panel adds 2" making the depth 24"
- Plinth base is veneer and recessed 1" on all sides
- One section of wire management channel provided per table with Post Metal Leg and Open Frame Bases
- Pull-Out Waste/Recycling Bin size: 14" x 10-1/2" x 18"
- Only Woodgrain Laminate options are available for the Racetrack Base
- Racetrack Bases have a removable access door

REQUIRED INFORMATION (ORDER CANNOT BE ENTERED WITHOUT THIS INFORMATION)

See appendix pages vi-viii for surface material options.

- Choose Laminate Finish
- Choose Veneer Finish
- Choose Metal Finish, if -OF or -ML Base is specified (Clear Anodized (-CA) is an option on the Post Metal Leg only)
- Choose Solid Edge Band Finish or Coordinating Woodgrain Edge Band Finish



LAMINATE TOP WITH SQUARE EDGE / VENEER CASE



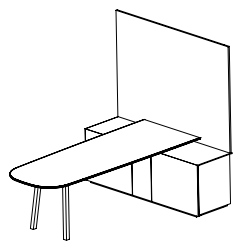
D-SHAPE TOP

BASE KEY

OF	Open Frame	RCL	Laminate Racetrack Base
ML	Post Metal Leg	RCP	Painted Racetrack Base
		RCV	Veneer Racetrack Base

D-SHAPE TOP // 60" CREDENZA BASE // SEATED HEIGHT

MODEL #	LENGTH	WIDTH	HEIGHT	CREDENZA BASE	SEATING CAPACITY	-OF	-ML	-RCL	-RCP	-RCV
TFL-3060-PE	60	30	29-1/2	60	3	8,516	8,516	-	-	-
TFL-3660-PE	60	36	29-1/2	60	3	8,709	8,709	-	-	-
TFL-4260-PE	60	42	29-1/2	60	3	9,682	9,682	-	-	-
TFL-4860-PE	60	48	29-1/2	60	3	10,233	10,233	-	-	-
TFL-3066-PE	66	30	29-1/2	60	3	9,119	9,119	-	-	-
TFL-3666-PE	66	36	29-1/2	60	3	9,343	9,343	-	-	-
TFL-4266-PE	66	42	29-1/2	60	3	10,406	10,406	-	-	-
TFL-4866-PE	66	48	29-1/2	60	3	11,018	11,018	-	-	-
TFL-3072-PE	72	30	29-1/2	60	3	9,247	9,247	-	-	-
TFL-3672-PE	72	36	29-1/2	60	3	9,492	9,492	-	-	-
TFL-4272-PE	72	42	29-1/2	60	3	10,591	10,591	10,591	11,108	11,657
TFL-4872-PE	72	48	29-1/2	60	3	11,232	11,232	11,232	11,767	12,335
TFL-3078-PE	78	30	29-1/2	60	5	10,028	10,028	-	-	-
TFL-3678-PE	78	36	29-1/2	60	5	10,311	10,311	-	-	-
TFL-4278-PE	78	42	29-1/2	60	5	11,523	11,523	11,523	12,077	12,663
TFL-4878-PE	78	48	29-1/2	60	5	12,240	12,240	12,240	12,813	13,419
TFL-3084-PE	84	30	29-1/2	60	5	10,165	10,165	-	-	-
TFL-3684-PE	84	36	29-1/2	60	5	10,471	10,471	-	-	-
TFL-4284-PE	84	42	29-1/2	60	5	11,720	11,720	11,720	12,273	12,860
TFL-4884-PE	84	48	29-1/2	60	5	12,468	12,468	12,468	13,041	13,648
TFL-3090-PE	90	30	29-1/2	60	5	10,838	10,838	-	-	-
TFL-3690-PE	90	36	29-1/2	60	5	11,182	11,182	-	-	-
TFL-4290-PE	90	42	29-1/2	60	5	12,537	12,537	12,537	13,118	13,735
TFL-4890-PE	90	48	29-1/2	60	5	13,357	13,357	13,357	13,959	14,597
TFL-3096-PE	96	30	29-1/2	60	5	10,982	10,982	-	-	-
TFL-3696-PE	96	36	29-1/2	60	5	11,350	11,350	-	-	-
TFL-4296-PE	96	42	29-1/2	60	5	12,744	12,744	12,744	13,326	13,943
TFL-4896-PE	96	48	29-1/2	60	5	13,597	13,597	13,597	14,200	14,837



Shown with optional Monitor Panel (-MP)

OPTIONS

Power & Data Options

See pages 112-122

Polished Chrome Finish Options:

Polished Chrome Open Frame Base	Add -PCOF-TWA	\$1,357
Polished Chrome Post Metal Legs	Add -PCML-TWA	\$626

Credenza Base Options:

60"-wide Monitor Panel	Add -MP	\$2,881
Pull-out Waste/Recycling Unit (Left End Opening)	Add -TE	\$508
Locks	Add -L	\$257

EDGE PROFILE



Two4Six Square Edge

GENERAL INFORMATION

- Tops are 1-1/8"-thick
- Seating capacity based on 27" per person
- Overall table height 29.5", Overall height 78" if Monitor Panel is specified.
- Standard with quarter cut veneer
- Pull-Out Waste/Recycling option is located on left side of unit if specified
- Adjustable shelves standard
- Access door on the credenza base standard with a lock. All doors will be keyed alike if locks are specified.
- Credenza base is 22"-deep, the Monitor Panel adds 2" making the depth 24"
- Plinth base is veneer and recessed 1" on all sides
- One section of wire management channel provided per table with Post Metal Leg and Open Frame Bases
- Pull-Out Waste/Recycling Bin size: 14" x 10-1/2" x 18"
- Only Woodgrain Laminate options are available for the Racetrack Base
- Racetrack Bases have a removable access door

REQUIRED INFORMATION (ORDER CANNOT BE ENTERED WITHOUT THIS INFORMATION)

See appendix pages vi-viii for surface material options.

- Choose Laminate Finish
- Choose Solid Edge Band Finish or Coordinating Woodgrain Edge Band Finish
- Choose Veneer Finish
- Choose Metal Finish, if -OF or -ML Base is specified (Clear Anodized (-CA) is an option on the Post Metal Leg only)



GLASS TOP / VENEER CASE



D-SHAPE TOP

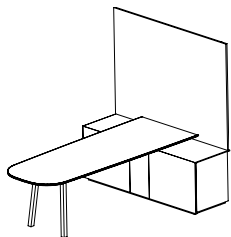
BASE KEY

OF Open Frame

RCL Laminate Racetrack Base
RCP Painted Racetrack Base
RCV Veneer Racetrack Base

D-SHAPE TOP // 60" CREDENZA BASE // SEATED HEIGHT

MODEL #	LENGTH	WIDTH	HEIGHT	CREDENZA BASE	SEATING CAPACITY	-OF	-RCL	-RCP	-RCV
TFL-3060-G	60	30	29-1/2	60	3	14,794	-	-	-
TFL-3660-G	60	36	29-1/2	60	3	15,129	-	-	-
TFL-4260-G	60	42	29-1/2	60	3	16,819	-	-	-
TFL-4860-G	60	48	29-1/2	60	3	17,777	-	-	-
TFL-3066-G	66	30	29-1/2	60	3	15,841	-	-	-
TFL-3666-G	66	36	29-1/2	60	3	16,231	-	-	-
TFL-4266-G	66	42	29-1/2	60	3	18,076	-	-	-
TFL-4866-G	66	48	29-1/2	60	3	19,140	-	-	-
TFL-3072-G	72	30	29-1/2	60	3	16,064	-	-	-
TFL-3672-G	72	36	29-1/2	60	3	16,490	-	-	-
TFL-4272-G	72	42	29-1/2	60	3	18,398	18,398	19,296	20,249
TFL-4872-G	72	48	29-1/2	60	3	19,511	19,511	20,441	21,427
TFL-3078-G	78	30	29-1/2	60	5	17,419	-	-	-
TFL-3678-G	78	36	29-1/2	60	5	17,912	-	-	-
TFL-4278-G	78	42	29-1/2	60	5	20,017	20,017	20,979	21,998
TFL-4878-G	78	48	29-1/2	60	5	21,263	21,263	22,259	23,312
TFL-3084-G	84	30	29-1/2	60	5	17,658	-	-	-
TFL-3684-G	84	36	29-1/2	60	5	18,190	-	-	-
TFL-4284-G	84	42	29-1/2	60	5	20,360	20,360	21,321	22,340
TFL-4884-G	84	48	29-1/2	60	5	21,660	21,660	22,655	23,709
TFL-3090-G	90	30	29-1/2	60	5	18,827	-	-	-
TFL-3690-G	90	36	29-1/2	60	5	19,426	-	-	-
TFL-4290-G	90	42	29-1/2	60	5	21,778	21,778	22,789	23,861
TFL-4890-G	90	48	29-1/2	60	5	23,204	23,204	24,249	25,358
TFL-3096-G	96	30	29-1/2	60	5	19,078	-	-	-
TFL-3696-G	96	36	29-1/2	60	5	19,717	-	-	-
TFL-4296-G	96	42	29-1/2	60	5	22,138	22,138	23,149	24,221
TFL-4896-G	96	48	29-1/2	60	5	23,620	23,620	24,667	25,775



Shown with optional Monitor Panel (-MP)

OPTIONS

Power & Data Options

See pages 112-122

Polished Chrome Finish Options:

Polished Chrome Open Frame Base Add **-PCOF-TWA** \$1,357

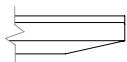
Satin Glass Options:

Satin Glass Add **-TFSG** \$691

Credenza Base Options:

60"-wide Monitor Panel Add **-MP** \$2,881
Pull-out Waste/Recycling Unit (Left End Opening) Add **-TE** \$508
Locks Add **-L** \$257

EDGE PROFILE



Two4Six Glass Edge

GENERAL INFORMATION

- Tops are 1-1/8"-thick with 3/16"-thick hardwood edge band
- Seating capacity based on 27" per person
- Overall table height 29.5". Overall height 78" if Monitor Panel is specified.
- Standard with quarter cut veneer
- Pull-Out Waste/Recycling option is located on left side of unit if specified
- Adjustable shelves standard
- All doors will be keyed alike if locks are specified
- Lock color will default to metal color
- Access door on the credenza base standard with a lock
- Credenza base is 22"-deep, the Monitor Panel adds 2" making the depth 24"
- Plinth base is veneer and recessed 1" on all sides
- One section of wire management channel provided per table
- Pull-Out Waste/Recycling Bin size: 14" x 10-1/2" x 18"
- Only Woodgrain Laminate options are available for the Racetrack Base
- Racetrack Bases have a removable access door

REQUIRED INFORMATION (ORDER CANNOT BE ENTERED WITHOUT THIS INFORMATION)

See appendix pages vi-viii for surface material options.

- Choose Glass Finish
- Choose Veneer Finish, if applicable
- Choose Paint Finish if -PA is specified
- Choose Metal Finish
- Choose Solid Edge Band Finish or Coordinating Woodgrain Edge Band Finish, if -RCL Base specified
- Choose Sub-Top Finish: Paint Finish or Wood Species & Finish



SOLID SURFACE TOP / VENEER CASE



D-SHAPE TOP

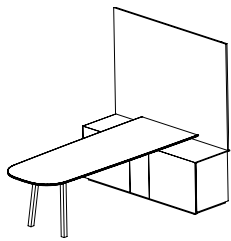
BASE KEY

OF Open Frame

RCL Laminate Racetrack Base
RCP Painted Racetrack Base
RCV Veneer Racetrack Base

D-SHAPE TOP // 60" CREDENZA BASE // SEATED HEIGHT

MODEL #	LENGTH	WIDTH	HEIGHT	CREDENZA BASE	SEATING CAPACITY	-OF	-RCL	-RCP	-RCV
TFL-3060-SS	60	30	29-1/2	60	3	15,458	-	-	-
TFL-3660-SS	60	36	29-1/2	60	3	15,808	-	-	-
TFL-4260-SS	60	42	29-1/2	60	3	17,574	-	-	-
TFL-4860-SS	60	48	29-1/2	60	3	18,574	-	-	-
TFL-3066-SS	66	30	29-1/2	60	3	16,552	-	-	-
TFL-3666-SS	66	36	29-1/2	60	3	16,959	-	-	-
TFL-4266-SS	66	42	29-1/2	60	3	18,887	-	-	-
TFL-4866-SS	66	48	29-1/2	60	3	19,999	-	-	-
TFL-3072-SS	72	30	29-1/2	60	3	16,785	-	-	-
TFL-3672-SS	72	36	29-1/2	60	3	17,230	-	-	-
TFL-4272-SS	72	42	29-1/2	60	3	19,223	19,223	20,162	21,158
TFL-4872-SS	72	48	29-1/2	60	3	20,387	20,387	21,358	22,389
TFL-3078-SS	78	30	29-1/2	60	5	18,201	-	-	-
TFL-3678-SS	78	36	29-1/2	60	5	18,716	-	-	-
TFL-4278-SS	78	42	29-1/2	60	5	20,915	20,915	21,921	22,985
TFL-4878-SS	78	48	29-1/2	60	5	22,217	22,217	23,257	24,358
TFL-3084-SS	84	30	29-1/2	60	5	18,450	-	-	-
TFL-3684-SS	84	36	29-1/2	60	5	19,006	-	-	-
TFL-4284-SS	84	42	29-1/2	60	5	21,274	21,274	22,278	23,342
TFL-4884-SS	84	48	29-1/2	60	5	22,631	22,631	23,671	24,773
TFL-3090-SS	90	30	29-1/2	60	5	19,671	-	-	-
TFL-3690-SS	90	36	29-1/2	60	5	20,297	-	-	-
TFL-4290-SS	90	42	29-1/2	60	5	22,755	22,755	23,812	24,931
TFL-4890-SS	90	48	29-1/2	60	5	24,245	24,245	25,337	26,496
TFL-3096-SS	96	30	29-1/2	60	5	19,934	-	-	-
TFL-3696-SS	96	36	29-1/2	60	5	20,602	-	-	-
TFL-4296-SS	96	42	29-1/2	60	5	23,132	23,132	24,188	25,308
TFL-4896-SS	96	48	29-1/2	60	5	24,680	24,680	25,774	26,931



Shown with optional Monitor Panel (-MP)

OPTIONS

Power & Data Options

See pages 112-122

Polished Chrome Finish Options:

Polished Chrome Open Frame Base Add **-PCOF-TWA** \$1,357

Credenza Base Options:

60"-wide Monitor Panel Add **-MP** \$2,881
 Pull-out Waste/Recycling Unit (Left End Opening) Add **-TE** \$508
 Locks Add **-L** \$257

EDGE PROFILE



Two4Six Solid Surface Edge

GENERAL INFORMATION

- Seating capacity based on 27" per person
- Overall table height 29.5". Overall height 78" if Monitor Panel is specified.
- Standard with quarter cut veneer
- Pull-Out Waste/Recycling option is located on left side of unit if specified
- Adjustable shelves standard
- All doors will be keyed alike if locks are specified
- Lock color will default to metal color
- Access door on the credenza base standard with a lock
- Credenza base is 22"-deep, the Monitor Panel adds 2" making the depth 24"
- Plinth base is veneer and recessed 1" on all sides
- One section of wire management channel provided per table
- Pull-Out Waste/Recycling Bin size: 14" x 10-1/2" x 18"
- Only Woodgrain Laminate options are available for the Racetrack Base
- Racetrack Bases have a removable access door

REQUIRED INFORMATION (ORDER CANNOT BE ENTERED WITHOUT THIS INFORMATION)

See appendix pages vi-viii for surface material options.

- Choose Solid Surface Finish
- Choose Veneer Finish, if applicable
- Choose Paint Finish if -PA is specified
- Choose Metal Finish
- Choose Solid Edge Band Finish or Coordinating Woodgrain Edge Band Finish, if -RCL Base specified



VENEER TOP WITH HARDWOOD EDGE / VENEER CASE



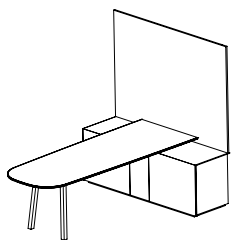
D-SHAPE TOP

BASE KEY

OF	Open Frame	RCL	Laminate Racetrack Base
ML	Post Metal Leg	RCP	Painted Racetrack Base
		RCV	Veneer Racetrack Base

D-SHAPE TOP // 72" CREDENZA BASE // SEATED HEIGHT

MODEL #	LENGTH	WIDTH	HEIGHT	CREDENZA BASE	SEATING CAPACITY	-OF	-ML	-RCL	-RCP	-RCV
TFX-3060-V	60	30	29-1/2	72	3	9,916	9,916	-	-	-
TFX-3660-V	60	36	29-1/2	72	3	10,131	10,131	-	-	-
TFX-4260-V	60	42	29-1/2	72	3	11,253	11,253	-	-	-
TFX-4860-V	60	48	29-1/2	72	3	11,883	11,883	-	-	-
TFX-3066-V	66	30	29-1/2	72	3	10,612	10,612	-	-	-
TFX-3666-V	66	36	29-1/2	72	3	10,862	10,862	-	-	-
TFX-4266-V	66	42	29-1/2	72	3	12,085	12,085	-	-	-
TFX-4866-V	66	48	29-1/2	72	3	12,784	12,784	-	-	-
TFX-3072-V	72	30	29-1/2	72	3	10,755	10,755	-	-	-
TFX-3672-V	72	36	29-1/2	72	3	11,028	11,028	-	-	-
TFX-4272-V	72	42	29-1/2	72	3	12,291	12,291	12,291	12,889	13,584
TFX-4872-V	72	48	29-1/2	72	3	13,022	13,022	13,022	13,641	14,360
TFX-3078-V	78	30	29-1/2	72	5	11,655	11,655	-	-	-
TFX-3678-V	78	36	29-1/2	72	5	11,971	11,971	-	-	-
TFX-4278-V	78	42	29-1/2	72	5	13,364	13,364	13,364	14,004	14,747
TFX-4878-V	78	48	29-1/2	72	5	14,181	14,181	14,181	14,843	15,612
TFX-3084-V	84	30	29-1/2	72	5	11,809	11,809	-	-	-
TFX-3684-V	84	36	29-1/2	72	5	12,150	12,150	-	-	-
TFX-4284-V	84	42	29-1/2	72	5	13,583	13,583	13,583	14,223	14,966
TFX-4884-V	84	48	29-1/2	72	5	14,435	14,435	14,435	15,097	15,866
TFX-3090-V	90	30	29-1/2	72	5	12,583	12,583	-	-	-
TFX-3690-V	90	36	29-1/2	72	5	12,967	12,967	-	-	-
TFX-4290-V	90	42	29-1/2	72	5	14,520	14,520	14,520	15,193	15,975
TFX-4890-V	90	48	29-1/2	72	5	15,453	15,453	15,453	16,149	16,959
TFX-3096-V	96	30	29-1/2	72	5	12,744	12,744	-	-	-
TFX-3696-V	96	36	29-1/2	72	5	13,154	13,154	-	-	-
TFX-4296-V	96	42	29-1/2	72	5	14,751	14,751	14,751	15,424	16,206
TFX-4896-V	96	48	29-1/2	72	5	15,720	15,720	15,720	16,417	17,226



Shown with optional Monitor Panel (-MP)

OPTIONS

Power & Data Options

See pages 112-122

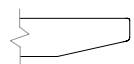
Polished Chrome Finish Options:

Polished Chrome Open Frame Base	Add -PCOF-TWA	\$1,357
Polished Chrome Post Metal Legs	Add -PCML-TWA	\$626

Credenza Base Options:

72" -wide Monitor Panel	Add -MP	\$3,106
Pull-out Waste/Recycling Unit (Left End Opening)	Add -TE	\$508
Sliding Equipment Rack (Right End Opening)	Add -R1	\$3,663
Locks	Add -L	\$257

EDGE PROFILE



Two4Six Cutback Edge

GENERAL INFORMATION

- Tops are 1-1/8" -thick with 3/16" -thick hardwood edge band
- Seating capacity based on 27" per person
- Overall table height 29.5". Overall height 78" if Monitor Panel is specified.
- Standard with quarter cut veneer
- Pull-Out Waste/Recycling option is located on left side of unit if specified
- Sliding Equipment Rack is located on the right end of the unit if specified
- Adjustable shelves standard
- Access door on the credenza base standard with a lock
- All doors will be keyed alike if locks are specified
- Equipment Rack - 12RU with thermostatically controlled fan
- Thermostatically-controlled fan activates automatically at 87° F and turns off at 85° F
- Credenza base is 22" -deep, the Monitor Panel adds 2" making the depth 24"
- Plinth base is veneer and recessed 1" on all sides
- One section of wire management channel provided per table with Post Metal Leg and Open Frame Bases
- Pull-Out Waste/Recycling Bin size: 14" x 10-1/2" x 18"
- Only Woodgrain Laminate options are available for the Racetrack Base
- Racetrack Bases have a removable access door

REQUIRED INFORMATION (ORDER CANNOT BE ENTERED WITHOUT THIS INFORMATION)

See appendix pages vi-viii for surface material options.

- Choose Veneer Finish
- Choose Metal Finish, if -OF or -ML Base is specified (Clear Anodized (-CA) is an option on the Post Metal Leg only)
- Choose Solid Edge Band Finish or Coordinating Woodgrain Edge Band Finish, if -RCL Base specified



INSET LAMINATE TOP WITH HARDWOOD EDGE / VENEER CASE



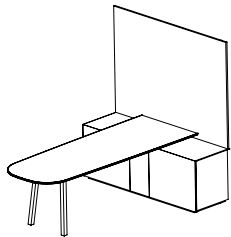
D-SHAPE TOP

BASE KEY

OF	Open Frame	RCL	Laminate Racetrack Base
ML	Post Metal Leg	RCP	Painted Racetrack Base
		RCV	Veneer Racetrack Base

D-SHAPE TOP // 72" CREDENZA BASE // SEATED HEIGHT

MODEL #	LENGTH	WIDTH	HEIGHT	CREDENZA BASE	SEATING CAPACITY	-OF	-ML	-RCL	-RCP	-RCV
TFX-3060-P	60	30	29-1/2	72	3	9,371	9,371	-	-	-
TFX-3660-P	60	36	29-1/2	72	3	9,574	9,574	-	-	-
TFX-4260-P	60	42	29-1/2	72	3	10,635	10,635	-	-	-
TFX-4860-P	60	48	29-1/2	72	3	11,230	11,230	-	-	-
TFX-3066-P	66	30	29-1/2	72	3	10,029	10,029	-	-	-
TFX-3666-P	66	36	29-1/2	72	3	10,265	10,265	-	-	-
TFX-4266-P	66	42	29-1/2	72	3	11,421	11,421	-	-	-
TFX-4866-P	66	48	29-1/2	72	3	12,081	12,081	-	-	-
TFX-3072-P	72	30	29-1/2	72	3	10,164	10,164	-	-	-
TFX-3672-P	72	36	29-1/2	72	3	10,422	10,422	-	-	-
TFX-4272-P	72	42	29-1/2	72	3	11,615	11,615	11,615	12,181	12,837
TFX-4872-P	72	48	29-1/2	72	3	12,306	12,306	12,306	12,891	13,571
TFX-3078-P	78	30	29-1/2	72	5	11,014	11,014	-	-	-
TFX-3678-P	78	36	29-1/2	72	5	11,313	11,313	-	-	-
TFX-4278-P	78	42	29-1/2	72	5	12,629	12,629	12,629	13,234	13,936
TFX-4878-P	78	48	29-1/2	72	5	13,402	13,402	13,402	14,027	14,754
TFX-3084-P	84	30	29-1/2	72	5	11,160	11,160	-	-	-
TFX-3684-P	84	36	29-1/2	72	5	11,482	11,482	-	-	-
TFX-4284-P	84	42	29-1/2	72	5	12,836	12,836	12,836	13,441	14,143
TFX-4884-P	84	48	29-1/2	72	5	13,642	13,642	13,642	14,267	14,994
TFX-3090-P	90	30	29-1/2	72	5	11,891	11,891	-	-	-
TFX-3690-P	90	36	29-1/2	72	5	12,254	12,254	-	-	-
TFX-4290-P	90	42	29-1/2	72	5	13,722	13,722	13,722	14,358	15,097
TFX-4890-P	90	48	29-1/2	72	5	14,604	14,604	14,604	15,261	16,027
TFX-3096-P	96	30	29-1/2	72	5	12,044	12,044	-	-	-
TFX-3696-P	96	36	29-1/2	72	5	12,431	12,431	-	-	-
TFX-4296-P	96	42	29-1/2	72	5	13,940	13,940	13,940	14,576	15,315
TFX-4896-P	96	48	29-1/2	72	5	14,856	14,856	14,856	15,515	16,279



Shown with optional Monitor Panel (-MP)

OPTIONS

Power & Data Options

CODE

PRICE

NOTES

See pages 112-122

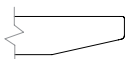
Polished Chrome Finish Options:

Polished Chrome Open Frame Base	Add -PCOF-TWA	\$1,357
Polished Chrome Post Metal Legs	Add -PCML-TWA	\$626

Credenza Base Options:

72"-wide Monitor Panel	Add -MP	\$3,106
Pull-out Waste/Recycling Unit (Left End Opening)	Add -TE	\$508
Sliding Equipment Rack (Right End Opening)	Add -R1	\$3,663
Locks	Add -L	\$257

EDGE PROFILE



Two4Six Cutback Edge

GENERAL INFORMATION

- Tops are 1-1/8"-thick
- Seating capacity based on 27" per person
- Overall table height 29.5". Overall height 78" if Monitor Panel is specified.
- Standard with quarter cut veneer
- Pull-Out Waste/Recycling option is located on left side of unit if specified
- Sliding Equipment Rack is located on the right end of the unit if specified
- Adjustable shelves standard
- Access door on the credenza base standard with a lock
- All doors will be keyed alike if locks are specified
- Equipment Rack - 12RU with thermostatically controlled fan
- Thermostatically-controlled fan activates automatically at 87° F and turns off at 85° F
- Credenza base is 22"-deep, the Monitor Panel adds 2" making the depth 24"
- Plinth base is veneer and recessed 1" on all sides
- One section of wire management channel provided per table with Post Metal Leg and Open Frame Bases
- Pull-Out Waste/Recycling Bin size: 14" x 10-1/2" x 18"
- Only Woodgrain Laminate options are available for the Racetrack Base
- Racetrack Bases have a removable access door

REQUIRED INFORMATION (ORDER CANNOT BE ENTERED WITHOUT THIS INFORMATION)

See appendix pages vi-viii for surface material options.

- Choose Laminate Finish
- Choose Wood Species & Finish for Hardwood Edge
- Choose Veneer Finish
- Choose Metal Finish, if -OF or -ML Base is specified (Clear Anodized (-CA) is an option on the Post Metal Leg only)
- Choose Solid Edge Band Finish or Coordinating Woodgrain Edge Band Finish, if -RCL Base specified



LAMINATE TOP WITH CUTBACK EDGE / VENEER CASE



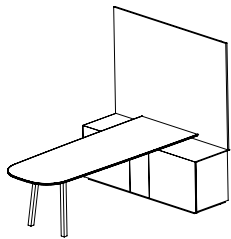
D-SHAPE TOP

BASE KEY

OF	Open Frame	RCL	Laminate Racetrack Base
ML	Post Metal Leg	RCP	Painted Racetrack Base
		RCV	Veneer Racetrack Base

D-SHAPE TOP // 72" CREDENZA BASE // SEATED HEIGHT

MODEL #	LENGTH	WIDTH	HEIGHT	CREDENZA BASE	SEATING CAPACITY	-OF	-ML	-RCL	-RCP	-RCV
TFX-3060-PA	60	30	29-1/2	72	3	9,371	9,371	-	-	-
TFX-3660-PA	60	36	29-1/2	72	3	9,574	9,574	-	-	-
TFX-4260-PA	60	42	29-1/2	72	3	10,635	10,635	-	-	-
TFX-4860-PA	60	48	29-1/2	72	3	11,230	11,230	-	-	-
TFX-3066-PA	66	30	29-1/2	72	3	10,029	10,029	-	-	-
TFX-3666-PA	66	36	29-1/2	72	3	10,265	10,265	-	-	-
TFX-4266-PA	66	42	29-1/2	72	3	11,421	11,421	-	-	-
TFX-4866-PA	66	48	29-1/2	72	3	12,081	12,081	-	-	-
TFX-3072-PA	72	30	29-1/2	72	3	10,164	10,164	-	-	-
TFX-3672-PA	72	36	29-1/2	72	3	10,422	10,422	-	-	-
TFX-4272-PA	72	42	29-1/2	72	3	11,615	11,615	11,615	12,181	12,837
TFX-4872-PA	72	48	29-1/2	72	3	12,306	12,306	12,306	12,891	13,571
TFX-3078-PA	78	30	29-1/2	72	5	11,014	11,014	-	-	-
TFX-3678-PA	78	36	29-1/2	72	5	11,313	11,313	-	-	-
TFX-4278-PA	78	42	29-1/2	72	5	12,629	12,629	12,629	13,234	13,936
TFX-4878-PA	78	48	29-1/2	72	5	13,402	13,402	13,402	14,027	14,754
TFX-3084-PA	84	30	29-1/2	72	5	11,160	11,160	-	-	-
TFX-3684-PA	84	36	29-1/2	72	5	11,482	11,482	-	-	-
TFX-4284-PA	84	42	29-1/2	72	5	12,836	12,836	12,836	13,441	14,143
TFX-4884-PA	84	48	29-1/2	72	5	13,642	13,642	13,642	14,267	14,994
TFX-3090-PA	90	30	29-1/2	72	5	11,891	11,891	-	-	-
TFX-3690-PA	90	36	29-1/2	72	5	12,254	12,254	-	-	-
TFX-4290-PA	90	42	29-1/2	72	5	13,722	13,722	13,722	14,358	15,097
TFX-4890-PA	90	48	29-1/2	72	5	14,604	14,604	14,604	15,261	16,027
TFX-3096-PA	96	30	29-1/2	72	5	12,044	12,044	-	-	-
TFX-3696-PA	96	36	29-1/2	72	5	12,431	12,431	-	-	-
TFX-4296-PA	96	42	29-1/2	72	5	13,940	13,940	13,940	14,576	15,315
TFX-4896-PA	96	48	29-1/2	72	5	14,856	14,856	14,856	15,515	16,279



Shown with optional Monitor Panel (-MP)

OPTIONS

Power & Data Options

See pages 112-122

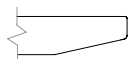
Polished Chrome Finish Options:

Polished Chrome Open Frame Base	Add -PCOF-TWA	\$1,357
Polished Chrome Post Metal Legs	Add -PCML-TWA	\$626

Credenza Base Options:

72"-wide Monitor Panel	Add -MP	\$3,106
Pull-out Waste/Recycling Unit (Left End Opening)	Add -TE	\$508
Sliding Equipment Rack (Right End Opening)	Add -R1	\$3,663
Locks	Add -L	\$257

EDGE PROFILE



Two4Six Cutback Edge

GENERAL INFORMATION

- Tops are 1-1/8"-thick
- Seating capacity based on 27" per person
- Overall table height 29.5". Overall height 78" if Monitor Panel is specified.
- Standard with quarter cut veneer
- Pull-Out Waste/Recycling option is located on left side of unit if specified
- Sliding Equipment Rack is located on the right end of the unit if specified
- Adjustable shelves standard
- Access door on the credenza base standard with a lock
- All doors will be keyed alike if locks are specified
- Equipment Rack - 12RU with thermostatically controlled fan
- Thermostatically-controlled fan activates automatically at 87° F and turns off at 85° F
- Credenza base is 22"-deep, the Monitor Panel adds 2" making the depth 24"
- Plinth base is veneer and recessed 1" on all sides
- One section of wire management channel provided per table with Post Metal Leg and Open Frame Bases
- Pull-Out Waste/Recycling Bin size: 14" x 10-1/2" x 18"
- Only Woodgrain Laminate options are available for the Racetrack Base
- Racetrack Bases have a removable access door

REQUIRED INFORMATION (ORDER CANNOT BE ENTERED WITHOUT THIS INFORMATION)

See appendix pages vi-viii for surface material options.

- Choose Laminate Finish
- Choose Solid Edge Band Finish or Coordinating Woodgrain Edge Band Finish
- Choose Veneer Finish
- Choose Metal Finish, if -OF or -ML Base is specified (Clear Anodized (-CA) is an option on the Post Metal Leg only)



LAMINATE TOP WITH SQUARE EDGE / VENEER CASE



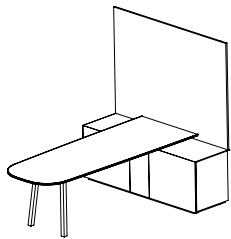
D-SHAPE TOP

BASE KEY

OF	Open Frame	RCL	Laminate Racetrack Base
ML	Post Metal Leg	RCP	Painted Racetrack Base
		RCV	Veneer Racetrack Base

D-SHAPE TOP // 72" CREDENZA BASE // SEATED HEIGHT

MODEL #	LENGTH	WIDTH	HEIGHT	CREDENZA BASE	SEATING CAPACITY	-OF	-ML	-RCL	-RCP	-RCV
TFX-3060-PE	60	30	29-1/2	72	3	8,905	8,905	-	-	-
TFX-3660-PE	60	36	29-1/2	72	3	9,098	9,098	-	-	-
TFX-4260-PE	60	42	29-1/2	72	3	10,106	10,106	-	-	-
TFX-4860-PE	60	48	29-1/2	72	3	10,671	10,671	-	-	-
TFX-3066-PE	66	30	29-1/2	72	3	9,530	9,530	-	-	-
TFX-3666-PE	66	36	29-1/2	72	3	9,755	9,755	-	-	-
TFX-4266-PE	66	42	29-1/2	72	3	10,853	10,853	-	-	-
TFX-4866-PE	66	48	29-1/2	72	3	11,481	11,481	-	-	-
TFX-3072-PE	72	30	29-1/2	72	3	9,658	9,658	-	-	-
TFX-3672-PE	72	36	29-1/2	72	3	9,904	9,904	-	-	-
TFX-4272-PE	72	42	29-1/2	72	3	11,038	11,038	11,038	11,575	12,199
TFX-4872-PE	72	48	29-1/2	72	3	11,694	11,694	11,694	12,250	12,896
TFX-3078-PE	78	30	29-1/2	72	5	10,467	10,467	-	-	-
TFX-3678-PE	78	36	29-1/2	72	5	10,750	10,750	-	-	-
TFX-4278-PE	78	42	29-1/2	72	5	12,001	12,001	12,001	12,576	13,243
TFX-4878-PE	78	48	29-1/2	72	5	12,735	12,735	12,735	13,330	14,020
TFX-3084-PE	84	30	29-1/2	72	5	10,605	10,605	-	-	-
TFX-3684-PE	84	36	29-1/2	72	5	10,911	10,911	-	-	-
TFX-4284-PE	84	42	29-1/2	72	5	12,198	12,198	12,198	12,773	13,440
TFX-4884-PE	84	48	29-1/2	72	5	12,963	12,963	12,963	13,558	14,248
TFX-3090-PE	90	30	29-1/2	72	5	11,300	11,300	-	-	-
TFX-3690-PE	90	36	29-1/2	72	5	11,645	11,645	-	-	-
TFX-4290-PE	90	42	29-1/2	72	5	13,039	13,039	13,039	13,644	14,346
TFX-4890-PE	90	48	29-1/2	72	5	13,877	13,877	13,877	14,502	15,230
TFX-3096-PE	96	30	29-1/2	72	5	11,445	11,445	-	-	-
TFX-3696-PE	96	36	29-1/2	72	5	11,813	11,813	-	-	-
TFX-4296-PE	96	42	29-1/2	72	5	13,247	13,247	13,247	13,851	14,553
TFX-4896-PE	96	48	29-1/2	72	5	14,117	14,117	14,117	14,743	15,469



Shown with optional Monitor Panel (-MP)

OPTIONS

Power & Data Options

See pages 112-122

Polished Chrome Finish Options:

Polished Chrome Open Frame Base	Add -PCOF-TWA	\$1,357
Polished Chrome Post Metal Legs	Add -PCML-TWA	\$626

Credenza Base Options:

72"-wide Monitor Panel	Add -MP	\$3,106
Pull-out Waste/Recycling Unit (Left End Opening)	Add -TE	\$508
Sliding Equipment Rack (Right End Opening)	Add -R1	\$3,663
Locks	Add -L	\$257

EDGE PROFILE



Two4Six Square Edge

GENERAL INFORMATION

- Tops are 1-1/8"-thick
- Seating capacity based on 27" per person
- Overall table height 29.5". Overall height 78" if Monitor Panel is specified.
- Standard with quarter cut veneer
- Pull-Out Waste/Recycling option is located on left side of unit if specified
- Sliding Equipment Rack is located on the right end of the unit if specified
- Adjustable shelves standard
- Access door on the credenza base standard with a lock
- All doors will be keyed alike if locks are specified
- Equipment Rack - 12RU with thermostatically controlled fan
- Thermostatically-controlled fan activates automatically at 87° F and turns off at 85° F
- Credenza base is 22"-deep, the Monitor Panel adds 2" making the depth 24"
- Plinth base is veneer and recessed 1" on all sides
- One section of wire management channel provided per table with Post Metal Leg and Open Frame Bases
- Pull-Out Waste/Recycling Bin size: 14" x 10-1/2" x 18"
- Only Woodgrain Laminate options are available for the Racetrack Base
- Racetrack Bases have a removable access door

REQUIRED INFORMATION (ORDER CANNOT BE ENTERED WITHOUT THIS INFORMATION)

See appendix pages vi-viii for surface material options.

- Choose Laminate Finish
- Choose Solid Edge Band Finish or Coordinating Woodgrain Edge Band Finish
- Choose Veneer Finish
- Choose Metal Finish, if -OF or -ML Base is specified (Clear Anodized (-CA) is an option on the Post Metal Leg only)



GLASS TOP / VENEER CASE



D-SHAPE TOP

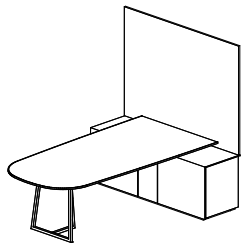
BASE KEY

OF Open Frame

RCL Laminate Racetrack Base
RCP Painted Racetrack Base
RCV Veneer Racetrack Base

D-SHAPE TOP // 72" CREDENZA BASE // SEATED HEIGHT

MODEL #	LENGTH	WIDTH	HEIGHT	CREDENZA BASE	SEATING CAPACITY	-OF	-RCL	-RCP	-RCV
TFX-3060-G	60	30	29-1/2	72	3	15,469	-	-	-
TFX-3660-G	60	36	29-1/2	72	3	15,805	-	-	-
TFX-4260-G	60	42	29-1/2	72	3	17,555	-	-	-
TFX-4860-G	60	48	29-1/2	72	3	18,538	-	-	-
TFX-3066-G	66	30	29-1/2	72	3	16,555	-	-	-
TFX-3666-G	66	36	29-1/2	72	3	16,945	-	-	-
TFX-4266-G	66	42	29-1/2	72	3	18,853	-	-	-
TFX-4866-G	66	48	29-1/2	72	3	19,944	-	-	-
TFX-3072-G	72	30	29-1/2	72	3	16,778	-	-	-
TFX-3672-G	72	36	29-1/2	72	3	17,204	-	-	-
TFX-4272-G	72	42	29-1/2	72	3	19,174	19,174	20,107	21,192
TFX-4872-G	72	48	29-1/2	72	3	20,315	20,315	21,280	22,402
TFX-3078-G	78	30	29-1/2	72	5	18,182	-	-	-
TFX-3678-G	78	36	29-1/2	72	5	18,675	-	-	-
TFX-4278-G	78	42	29-1/2	72	5	20,848	20,848	21,847	23,006
TFX-4878-G	78	48	29-1/2	72	5	22,123	22,123	23,156	24,355
TFX-3084-G	84	30	29-1/2	72	5	18,423	-	-	-
TFX-3684-G	84	36	29-1/2	72	5	18,954	-	-	-
TFX-4284-G	84	42	29-1/2	72	5	21,190	21,190	22,188	23,347
TFX-4884-G	84	48	29-1/2	72	5	22,519	22,519	23,552	24,751
TFX-3090-G	90	30	29-1/2	72	5	19,630	-	-	-
TFX-3690-G	90	36	29-1/2	72	5	20,229	-	-	-
TFX-4290-G	90	42	29-1/2	72	5	22,652	22,652	23,702	24,921
TFX-4890-G	90	48	29-1/2	72	5	24,107	24,107	25,193	26,457
TFX-3096-G	96	30	29-1/2	72	5	19,881	-	-	-
TFX-3696-G	96	36	29-1/2	72	5	20,521	-	-	-
TFX-4296-G	96	42	29-1/2	72	5	23,012	23,012	24,062	25,282
TFX-4896-G	96	48	29-1/2	72	5	24,524	24,524	25,611	26,873



Shown with optional Monitor Panel (-MP)

OPTIONS

Power & Data Options

See pages 112-122

Polished Chrome Finish Options:

Polished Chrome Open Frame Base Add **-PCOF-TWA** \$1,357

Satin Glass Options:

Satin Glass Add **-TFSG** \$691

Credenza Base Options:

72"-wide Monitor Panel Add **-MP** \$3,106
 Pull-out Waste/Recycling Unit (Left End Opening) Add **-TE** \$508
 Sliding Equipment Rack (Right End Opening) Add **-R1** \$3,663
 Locks Add **-L** \$257

CODE PRICE

NOTES

EDGE PROFILE



Two4Six Glass Edge

GENERAL INFORMATION

- Tops are 1-1/8"-thick
- Seating capacity based on 27" per person
- Overall table height 29.5". Overall height 78" if Monitor Panel is specified.
- Standard with quarter cut veneer
- Pull-Out Waste/Recycling option is located on left side of unit if specified
- Sliding Equipment Rack is located on the right end of the unit if specified
- Adjustable shelves standard
- Access door on the credenza base standard with a lock
- All doors will be keyed alike if locks are specified
- Equipment Rack - 12RU with thermostatically controlled fan
- Thermostatically-controlled fan activates automatically at 87° F and turns off at 85° F
- Credenza base is 22"-deep, the Monitor Panel adds 2" making the depth 24"
- Plinth base is veneer and recessed 1" on all sides
- One section of wire management channel provided per table with Post Metal Leg and Open Frame Bases
- Pull-Out Waste/Recycling Bin size: 14" x 10-1/2" x 18"
- Only Woodgrain Laminate options are available for the Racetrack Base
- Racetrack Bases have a removable access door

REQUIRED INFORMATION (ORDER CANNOT BE ENTERED WITHOUT THIS INFORMATION)

See appendix pages vi-viii for surface material options.

- Choose Glass Finish
- Choose Veneer Finish, if applicable
- Choose Paint Finish if -PA is specified
- Choose Metal Finish
- Choose Solid Edge Band Finish or Coordinating Woodgrain Edge Band Finish, if -RCL Base specified
- Choose Sub-Top Finish: Paint Finish or Wood Species & Finish



SOLID SURFACE TOP / VENEER CASE



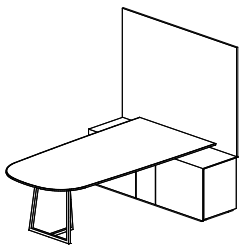
D-SHAPE TOP

BASE KEY

OF	Open Frame	RCL	Laminate Racetrack Base
RCP		RCV	Painted Racetrack Base
			Veneer Racetrack Base

D-SHAPE TOP // 72" CREDENZA BASE // SEATED HEIGHT

MODEL #	LENGTH	WIDTH	HEIGHT	CREDENZA BASE	SEATING CAPACITY	-OF	-RCL	-RCP	-RCV
TFX-3060-SS	60	30	29-1/2	72	3	16,164	-	-	-
TFX-3660-SS	60	36	29-1/2	72	3	16,514	-	-	-
TFX-4260-SS	60	42	29-1/2	72	3	18,343	-	-	-
TFX-4860-SS	60	48	29-1/2	72	3	19,370	-	-	-
TFX-3066-SS	66	30	29-1/2	72	3	17,298	-	-	-
TFX-3666-SS	66	36	29-1/2	72	3	17,706	-	-	-
TFX-4266-SS	66	42	29-1/2	72	3	19,699	-	-	-
TFX-4866-SS	66	48	29-1/2	72	3	20,838	-	-	-
TFX-3072-SS	72	30	29-1/2	72	3	17,531	-	-	-
TFX-3672-SS	72	36	29-1/2	72	3	17,976	-	-	-
TFX-4272-SS	72	42	29-1/2	72	3	20,035	20,035	21,010	22,142
TFX-4872-SS	72	48	29-1/2	72	3	21,226	21,226	22,235	23,407
TFX-3078-SS	78	30	29-1/2	72	5	18,998	-	-	-
TFX-3678-SS	78	36	29-1/2	72	5	19,513	-	-	-
TFX-4278-SS	78	42	29-1/2	72	5	21,784	21,784	22,827	24,038
TFX-4878-SS	78	48	29-1/2	72	5	23,116	23,116	24,195	25,448
TFX-3084-SS	84	30	29-1/2	72	5	19,249	-	-	-
TFX-3684-SS	84	36	29-1/2	72	5	19,805	-	-	-
TFX-4284-SS	84	42	29-1/2	72	5	22,141	22,141	23,184	24,395
TFX-4884-SS	84	48	29-1/2	72	5	23,530	23,530	24,609	25,862
TFX-3090-SS	90	30	29-1/2	72	5	20,511	-	-	-
TFX-3690-SS	90	36	29-1/2	72	5	21,137	-	-	-
TFX-4290-SS	90	42	29-1/2	72	5	23,668	23,668	24,765	26,040
TFX-4890-SS	90	48	29-1/2	72	5	25,189	25,189	26,323	27,644
TFX-3096-SS	96	30	29-1/2	72	5	20,773	-	-	-
TFX-3696-SS	96	36	29-1/2	72	5	21,442	-	-	-
TFX-4296-SS	96	42	29-1/2	72	5	24,045	24,045	25,142	26,416
TFX-4896-SS	96	48	29-1/2	72	5	25,624	25,624	26,760	28,079



Shown with optional Monitor Panel (-MP)

OPTIONS

Power & Data Options

See pages 112-122

Polished Chrome Finish Options:

Polished Chrome Open Frame Base Add **-PCOF-TWA** \$1,357

Credenza Base Options:

72"-wide Monitor Panel Add **-MP** \$3,106
 Pull-out Waste/Recycling Unit (Left End Opening) Add **-TE** \$508
 Sliding Equipment Rack (Right End Opening) Add **-R1** \$3,663
 Locks Add **-L** \$257

CODE PRICE NOTES

EDGE PROFILE



Two4Six Solid Surface Edge

GENERAL INFORMATION

- Seating capacity based on 27" per person
- Overall table height 29.5". Overall height 78" if Monitor Panel is specified.
- Standard with quarter cut veneer
- Pull-Out Waste/Recycling option is located on left side of unit if specified
- Sliding Equipment Rack is located on the right end of the unit if specified
- Adjustable shelves standard
- Access door on the credenza base standard with a lock.
- All doors will be keyed alike if locks are specified.
- Equipment Rack - 12RU with thermostatically controlled fan
- Thermostatically-controlled fan activates automatically at 87° F and turns off at 85° F
- Credenza base is 22"-deep, the Monitor Panel adds 2" making the depth 4"
- Plinth base is veneer and recessed 1" on all sides
- One section of wire management channel provided per table with Post Metal Leg and Open Frame Bases
- Pull-Out Waste/Recycling Bin size: 14" x 10-1/2" x 18"
- Only Woodgrain Laminate options are available for the Racetrack Base
- Racetrack Bases have a removable access door

REQUIRED INFORMATION (ORDER CANNOT BE ENTERED WITHOUT THIS INFORMATION)

See appendix pages vi-viii for surface material options.

- Choose Solid Surface Finish
- Choose Veneer Finish, if applicable
- Choose Paint Finish if -PA is specified
- Choose Metal Finish
- Choose Solid Edge Band Finish or Coordinating Woodgrain Edge Band Finish, if -RCL Base specified



VENEER TOP WITH HARDWOOD EDGE



D-SHAPE TOP

BASE KEY

OF	Open Frame	RCL	Laminate Racetrack Base
ML	Post Metal Leg	RCP	Painted Racetrack Base
		RCV	Veneer Racetrack Base

D-SHAPE TOP // SLAB BASE // SEATED HEIGHT

MODEL #	LENGTH	WIDTH	HEIGHT	SEATING CAPACITY	-OF	-ML	-RCL	-RCP	-RCV
TFE-3060-V []	60	30	29-1/2	4	4,163	4,163	-	-	-
TFE-3066-V []	66	30	29-1/2	5	4,538	4,538	-	-	-
TFE-3072-V []	72	30	29-1/2	5	4,681	4,681	-	-	-
TFE-3078-V []	78	30	29-1/2	5	5,160	5,160	-	-	-
TFE-3084-V []	84	30	29-1/2	7	5,313	5,313	-	-	-
TFE-3090-V []	90	30	29-1/2	7	5,750	5,750	-	-	-
TFE-3096-V []	96	30	29-1/2	7	5,911	5,911	-	-	-
TFE-3660-V []	60	36	29-1/2	5	4,378	4,378	-	-	-
TFE-3666-V []	66	36	29-1/2	5	4,788	4,788	-	-	-
TFE-3672-V []	72	36	29-1/2	5	4,954	4,954	-	-	-
TFE-3678-V []	78	36	29-1/2	5	5,476	5,476	-	-	-
TFE-3684-V []	84	36	29-1/2	7	5,654	5,654	-	-	-
TFE-3690-V []	90	36	29-1/2	7	6,134	6,134	-	-	-
TFE-3696-V []	96	36	29-1/2	7	6,321	6,321	-	-	-
TFE-4260-V []	60	42	29-1/2	5	4,996	4,996	-	-	-
TFE-4266-V []	66	42	29-1/2	5	5,479	5,479	-	-	-
TFE-4272-V []	72	42	29-1/2	5	5,685	5,685	5,685	5,951	6,249
TFE-4278-V []	78	42	29-1/2	5	6,300	6,300	6,300	6,584	6,903
TFE-4284-V []	84	42	29-1/2	7	6,519	6,519	6,519	6,804	7,122
TFE-4290-V []	90	42	29-1/2	7	7,089	7,089	7,089	7,389	7,723
TFE-4296-V []	96	42	29-1/2	7	7,320	7,320	7,320	7,620	7,954
TFE-4860-V []	60	48	29-1/2	5	5,411	5,411	-	-	-
TFE-4866-V []	66	48	29-1/2	5	5,951	5,951	-	-	-
TFE-4872-V []	72	48	29-1/2	5	6,189	6,189	6,189	6,464	6,772
TFE-4878-V []	78	48	29-1/2	7	6,873	6,873	6,873	7,168	7,497
TFE-4884-V []	84	48	29-1/2	7	7,128	7,128	7,128	7,422	7,751
TFE-4890-V []	90	48	29-1/2	7	7,766	7,766	7,766	8,076	8,422
TFE-4896-V []	96	48	29-1/2	7	8,033	8,033	8,033	8,343	8,689

[] Slab Base, Specify Paint (-PS) or Veneer (-V)

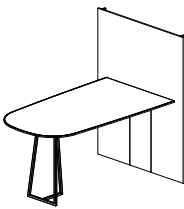
OPTIONS

CODE

PRICE

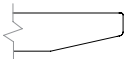
NOTES

Power & Data Options			See pages 112-122
Remove Slab Base	Add -WM	Deduct \$741	Mounted directly to wall
Polished Chrome Finish Options:			
Polished Chrome Open Frame Base	Add -PCOF-TWA	\$1,357	
Polished Chrome Post Metal Legs	Add -PCML-TWA	\$626	
Monitor Panel Options:			
42"-Wide Monitor Panel	Add -MP30	\$2,201	For use with 30"-Wide Tables
48"-Wide Monitor Panel	Add -MP36	\$2,426	For use with 36"-Wide Tables
54"-Wide Monitor Panel	Add -MP42	\$2,653	For use with 42"-Wide Tables
60"-Wide Monitor Panel	Add -MP48	\$2,881	For use with 48"-Wide Tables



Shown with optional Monitor Panel (-MP)

EDGE PROFILE



Two4Six Cutback Edge

GENERAL INFORMATION

- Tops are 1-1/8"-thick with 3/16"-thick hardwood edge band
- Seating capacity based on 27" per person
- Overall table height 29.5"
- Standard with quarter cut veneer
- Must be anchored to a wall, with or without Slab Base
- One section of wire management channel provided per table with Post Metal Leg and Open Frame Bases
- Monitor Panel will be 12" wider than the table specified
- Monitor Panel mounts directly to the wall
- Monitor Panel is 78" high
- Only Woodgrain Laminate options are available for the Racetrack Base
- Racetrack Bases have a removable access door

REQUIRED INFORMATION (ORDER CANNOT BE ENTERED WITHOUT THIS INFORMATION)

- See appendix pages vi-viii for surface material options.
- Choose Veneer Finish. If -V option is specified for the Slab Base, the finish will be the same as the table top.
 - Choose Paint Finish, if -PS Slab Base is specified
 - Choose Metal Finish, if -OF or -ML Base is specified (Clear Anodized (-CA) is an option on the Post Metal Leg only)
 - Choose Solid Edge Band Finish or Coordinating Woodgrain Edge Band Finish, if -RCL Base specified



INSET LAMINATE TOP WITH HARDWOOD EDGE



D-SHAPE TOP

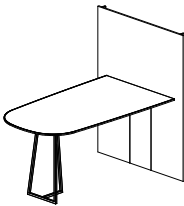
BASE KEY

OF	Open Frame	RCL	Laminate Racetrack Base
ML	Post Metal Leg	RCP	Painted Racetrack Base
		RCV	Veneer Racetrack Base

D-SHAPE TOP // SLAB BASE // SEATED HEIGHT

MODEL #	LENGTH	WIDTH	HEIGHT	SEATING CAPACITY	-OF	-ML	-RCL	-RCP	-RCV
TFE-3060-P []	60	30	29-1/2	4	3,935	3,935	-	-	-
TFE-3066-P []	66	30	29-1/2	5	4,289	4,289	-	-	-
TFE-3072-P []	72	30	29-1/2	5	4,424	4,424	-	-	-
TFE-3078-P []	78	30	29-1/2	5	4,877	4,877	-	-	-
TFE-3084-P []	84	30	29-1/2	7	5,021	5,021	-	-	-
TFE-3090-P []	90	30	29-1/2	7	5,434	5,434	-	-	-
TFE-3096-P []	96	30	29-1/2	7	5,586	5,586	-	-	-
TFE-3660-P []	60	36	29-1/2	5	4,138	4,138	-	-	-
TFE-3666-P []	66	36	29-1/2	5	4,525	4,525	-	-	-
TFE-3672-P []	72	36	29-1/2	5	4,682	4,682	-	-	-
TFE-3678-P []	78	36	29-1/2	5	5,175	5,175	-	-	-
TFE-3684-P []	84	36	29-1/2	7	5,344	5,344	-	-	-
TFE-3690-P []	90	36	29-1/2	7	5,797	5,797	-	-	-
TFE-3696-P []	96	36	29-1/2	7	5,974	5,974	-	-	-
TFE-4260-P []	60	42	29-1/2	5	4,722	4,722	-	-	-
TFE-4266-P []	66	42	29-1/2	5	5,178	5,178	-	-	-
TFE-4272-P []	72	42	29-1/2	5	5,373	5,373	5,373	5,624	5,906
TFE-4278-P []	78	42	29-1/2	5	5,954	5,954	5,954	6,222	6,524
TFE-4284-P []	84	42	29-1/2	7	6,161	6,161	6,161	6,430	6,731
TFE-4290-P []	90	42	29-1/2	7	6,700	6,700	6,700	6,983	7,299
TFE-4296-P []	96	42	29-1/2	7	6,918	6,918	6,918	7,201	7,517
TFE-4860-P []	60	48	29-1/2	5	5,114	5,114	-	-	-
TFE-4866-P []	66	48	29-1/2	5	5,624	5,624	-	-	-
TFE-4872-P []	72	48	29-1/2	5	5,849	5,849	5,849	6,109	6,400
TFE-4878-P []	78	48	29-1/2	7	6,495	6,495	6,495	6,774	7,085
TFE-4884-P []	84	48	29-1/2	7	6,736	6,736	6,736	7,014	7,325
TFE-4890-P []	90	48	29-1/2	7	7,339	7,339	7,339	7,632	7,959
TFE-4896-P []	96	48	29-1/2	7	7,592	7,592	7,592	7,885	8,212

[] Slab Base, Specify Paint (-PS) or Veneer (-V)

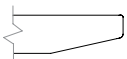


Shown with optional Monitor Panel (-MP)

OPTIONS

OPTIONS	CODE	PRICE	NOTES
Power & Data Options			See pages 112-122
Remove Slab Base	Add -WM	Deduct \$741	Mounted directly to wall
Polished Chrome Finish Options:			
Polished Chrome Open Frame Base	Add -PCOF-TWA	\$1,357	
Polished Chrome Post Metal Legs	Add -PCML-TWA	\$626	
Monitor Panel Options:			
42"-Wide Monitor Panel	Add -MP30	\$2,201	For use with 30"-Wide Tables
48"-Wide Monitor Panel	Add -MP36	\$2,426	For use with 36"-Wide Tables
54"-Wide Monitor Panel	Add -MP42	\$2,653	For use with 42"-Wide Tables
60"-Wide Monitor Panel	Add -MP48	\$2,881	For use with 48"-Wide Tables

EDGE PROFILE



Two4Six Cutback Edge

GENERAL INFORMATION

- Tops are 1-1/8"-thick with 3/16"-thick hardwood edge band
- Seating capacity based on 27" per person
- Overall table height 29.5"
- Standard with quarter cut veneer
- Must be anchored to a wall, with or without Slab Base
- One section of wire management channel provided per table with Post Metal Leg and Open Frame Bases
- Monitor Panel will be 12" wider than the table specified
- Monitor Panel mounts directly to the wall
- Monitor Panel is 78" high
- Monitor panel available in Paint or Veneer Finish options only
- Only Woodgrain Laminate options are available for the Racetrack Base
- Racetrack Bases have a removable access door

REQUIRED INFORMATION (ORDER CANNOT BE ENTERED WITHOUT THIS INFORMATION)

- See appendix pages vi-viii for surface material options.
- Choose Laminate Finish
 - Choose Wood Species & Finish for Hardwood Edge
 - Choose Paint Finish, if -PS Slab Base is specified
 - Choose Veneer Finish, if -V Slab Base is specified
 - Choose Metal Finish, if -OF or -ML Base is specified (Clear Anodized (-CA) is an option on the Post Metal Leg only)
 - Choose Solid Edge Band Finish or Coordinating Woodgrain Edge Band Finish, if -RCL Base specified



LAMINATE TOP WITH CUTBACK EDGE



D-SHAPE TOP

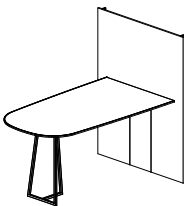
BASE KEY

OF	Open Frame	RCL	Laminate Racetrack Base
ML	Post Metal Leg	RCP	Painted Racetrack Base
		RCV	Veneer Racetrack Base

D-SHAPE TOP // SLAB BASE // SEATED HEIGHT

MODEL #	LENGTH	WIDTH	HEIGHT	SEATING CAPACITY	-OF	-ML	-RCL	-RCP	-RCV
TFE-3060-PA []	60	30	29-1/2	5	3,935	3,935	-	-	-
TFE-3066-PA []	66	30	29-1/2	5	4,289	4,289	-	-	-
TFE-3072-PA []	72	30	29-1/2	5	4,424	4,424	-	-	-
TFE-3078-PA []	78	30	29-1/2	5	4,877	4,877	-	-	-
TFE-3084-PA []	84	30	29-1/2	7	5,021	5,021	-	-	-
TFE-3090-PA []	90	30	29-1/2	7	5,434	5,434	-	-	-
TFE-3096-PA []	96	30	29-1/2	7	5,586	5,586	-	-	-
TFE-3660-PA []	60	36	29-1/2	5	4,138	4,138	-	-	-
TFE-3666-PA []	66	36	29-1/2	5	4,525	4,525	-	-	-
TFE-3672-PA []	72	36	29-1/2	5	4,682	4,682	-	-	-
TFE-3678-PA []	78	36	29-1/2	5	5,175	5,175	-	-	-
TFE-3684-PA []	84	36	29-1/2	7	5,344	5,344	-	-	-
TFE-3690-PA []	90	36	29-1/2	7	5,797	5,797	-	-	-
TFE-3696-PA []	96	36	29-1/2	7	5,974	5,974	-	-	-
TFE-4260-PA []	60	42	29-1/2	5	4,722	4,722	-	-	-
TFE-4266-PA []	66	42	29-1/2	5	5,178	5,178	-	-	-
TFE-4272-PA []	72	42	29-1/2	5	5,373	5,373	5,373	5,624	5,906
TFE-4278-PA []	78	42	29-1/2	5	5,954	5,954	5,954	6,222	6,524
TFE-4284-PA []	84	42	29-1/2	7	6,161	6,161	6,161	6,430	6,731
TFE-4290-PA []	90	42	29-1/2	7	6,700	6,700	6,700	6,983	7,299
TFE-4296-PA []	96	42	29-1/2	7	6,918	6,918	6,918	7,201	7,517
TFE-4860-PA []	60	48	29-1/2	5	5,114	5,114	-	-	-
TFE-4866-PA []	66	48	29-1/2	5	5,624	5,624	-	-	-
TFE-4872-PA []	72	48	29-1/2	5	5,849	5,849	5,849	6,109	6,400
TFE-4878-PA []	78	48	29-1/2	5	6,495	6,495	6,495	6,774	7,085
TFE-4884-PA []	84	48	29-1/2	7	6,736	6,736	6,736	7,014	7,325
TFE-4890-PA []	90	48	29-1/2	7	7,339	7,339	7,339	7,632	7,959
TFE-4896-PA []	96	48	29-1/2	7	7,592	7,592	7,592	7,885	8,212

[] Slab Base, Specify Paint (-PS) or Veneer (-V)

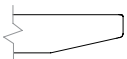


Shown with optional Monitor Panel (-MP)

OPTIONS

OPTIONS	CODE	PRICE	NOTES
Power & Data Options			See pages 112-122
Remove Slab Base	Add -WM	Deduct \$741	Mounted directly to wall
Polished Chrome Finish Options:			
Polished Chrome Open Frame Base	Add -PCOF-TWA	\$1,357	
Polished Chrome Post Metal Legs	Add -PCML-TWA	\$626	
Monitor Panel Options:			
42"-Wide Monitor Panel	Add -MP30	\$2,201	For use with 30"-Wide Tables
48"-Wide Monitor Panel	Add -MP36	\$2,426	For use with 36"-Wide Tables
54"-Wide Monitor Panel	Add -MP42	\$2,653	For use with 42"-Wide Tables
60"-Wide Monitor Panel	Add -MP48	\$2,881	For use with 48"-Wide Tables

EDGE PROFILE



Two4Six Cutback Edge

GENERAL INFORMATION

- Tops are 1-1/8"-thick with 3/16"-thick hardwood edge band
- Seating capacity based on 27" per person
- Overall table height 29.5"
- Standard with quarter cut veneer
- Must be anchored to a wall, with or without Slab Base
- One section of wire management channel provided per table with Post Metal Leg and Open Frame Bases
- Monitor Panel will be 12" wider than the table specified
- Monitor Panel mounts directly to the wall
- Monitor Panel is 78" high
- Monitor panel available in Paint or Veneer Finish options only
- Only Woodgrain Laminate options are available for the Racetrack Base
- Racetrack Bases have a removable access door

REQUIRED INFORMATION (ORDER CANNOT BE ENTERED WITHOUT THIS INFORMATION)

- See appendix pages vi-viii for surface material options.
- Choose Laminate Finish
 - Choose Edge Band Finish
 - Choose Paint Finish, if -PS Slab Base is specified
 - Choose Veneer Finish, if -V Slab Base is specified
 - Choose Metal Finish, if -OF or -ML Base is specified (Clear Anodized (-CA) is an option on the Post Metal Leg only)
 - Choose Solid Edge Band Finish or Coordinating Woodgrain Edge Band Finish, if -RCL Base specified



LAMINATE TOP WITH SQUARE EDGE



D-SHAPE TOP

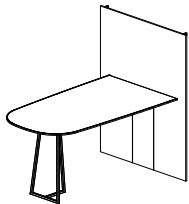
BASE KEY

OF	Open Frame	RCL	Laminate Racetrack Base
ML	Post Metal Leg	RCP	Painted Racetrack Base
		RCV	Veneer Racetrack Base

D-SHAPE TOP // SLAB BASE // SEATED HEIGHT

MODEL #	LENGTH	WIDTH	HEIGHT	SEATING CAPACITY	-OF	-ML	-RCL	-RCP	-RCV
TFE-3060-PE []	60	30	29-1/2	4	3,739	3,739	-	-	-
TFE-3066-PE []	66	30	29-1/2	5	4,076	4,076	-	-	-
TFE-3072-PE []	72	30	29-1/2	5	4,204	4,204	-	-	-
TFE-3078-PE []	78	30	29-1/2	5	4,634	4,634	-	-	-
TFE-3084-PE []	84	30	29-1/2	7	4,772	4,772	-	-	-
TFE-3090-PE []	90	30	29-1/2	7	5,164	5,164	-	-	-
TFE-3096-PE []	96	30	29-1/2	7	5,309	5,309	-	-	-
TFE-3660-PE []	60	36	29-1/2	5	3,932	3,932	-	-	-
TFE-3666-PE []	66	36	29-1/2	5	4,300	4,300	-	-	-
TFE-3672-PE []	72	36	29-1/2	5	4,449	4,449	-	-	-
TFE-3678-PE []	78	36	29-1/2	5	4,918	4,918	-	-	-
TFE-3684-PE []	84	36	29-1/2	7	5,078	5,078	-	-	-
TFE-3690-PE []	90	36	29-1/2	7	5,509	5,509	-	-	-
TFE-3696-PE []	96	36	29-1/2	7	5,677	5,677	-	-	-
TFE-4260-PE []	60	42	29-1/2	5	4,487	4,487	-	-	-
TFE-4266-PE []	66	42	29-1/2	5	4,921	4,921	-	-	-
TFE-4272-PE []	72	42	29-1/2	5	5,106	5,106	5,106	5,344	5,612
TFE-4278-PE []	78	42	29-1/2	5	5,658	5,658	5,658	5,913	6,199
TFE-4284-PE []	84	42	29-1/2	7	5,855	5,855	5,855	6,110	6,396
TFE-4290-PE []	90	42	29-1/2	7	6,366	6,366	6,366	6,636	6,936
TFE-4296-PE []	96	42	29-1/2	7	6,574	6,574	6,574	6,843	7,143
TFE-4860-PE []	60	48	29-1/2	5	4,860	4,860	-	-	-
TFE-4866-PE []	66	48	29-1/2	5	5,344	5,344	-	-	-
TFE-4872-PE []	72	48	29-1/2	5	5,558	5,558	5,558	5,805	6,082
TFE-4878-PE []	78	48	29-1/2	7	6,172	6,172	6,172	6,437	6,733
TFE-4884-PE []	84	48	29-1/2	7	6,401	6,401	6,401	6,665	6,961
TFE-4890-PE []	90	48	29-1/2	7	6,974	6,974	6,974	7,253	7,563
TFE-4896-PE []	96	48	29-1/2	7	7,214	7,214	7,214	7,493	7,803

[] Slab Base, Specify Paint (-PS) or Veneer (-V)



Shown with optional Monitor Panel (-MP)

OPTIONS

OPTIONS	CODE	PRICE	NOTES
Power & Data Options			See pages 112-122
Remove Slab Base	Add -WM	Deduct \$741	Mounted directly to wall
Polished Chrome Finish Options:			
Polished Chrome Open Frame Base	Add -PCOF-TWA	\$1,357	
Polished Chrome Post Metal Legs	Add -PCML-TWA	\$626	
Monitor Panel Options:			
42"-Wide Monitor Panel	Add -MP30	\$2,201	For use with 30"-Wide Tables
48"-Wide Monitor Panel	Add -MP36	\$2,426	For use with 36"-Wide Tables
54"-Wide Monitor Panel	Add -MP42	\$2,653	For use with 42"-Wide Tables
60"-Wide Monitor Panel	Add -MP48	\$2,881	For use with 48"-Wide Tables

EDGE PROFILE



Two4Six Square Edge

GENERAL INFORMATION

- Tops are 1-1/8"-thick
- Seating capacity based on 27" per person
- Overall table height 29.5"
- Standard with quarter cut veneer
- Must be anchored to a wall, with or without Slab Base
- One section of wire management channel provided per table with Post Metal Leg and Open Frame Bases
- Monitor Panel will be 12" wider than the table specified
- Monitor Panel mounts directly to the wall
- Monitor Panel is 78" high
- Monitor panel available in Paint or Veneer Finish options only
- Only Woodgrain Laminate options are available for the Racetrack Base
- Racetrack Bases have a removable access door

REQUIRED INFORMATION (ORDER CANNOT BE ENTERED WITHOUT THIS INFORMATION)

- See appendix pages vi-viii for surface material options.
- Choose Laminate Finish
 - Choose Solid Edge Band Finish or Coordinating Woodgrain Edge Band finish
 - Choose Paint Finish, if -PS Slab Base is specified
 - Choose Veneer Finish, if -V Slab Base is specified
 - Choose Metal Finish, if -OF or -ML Base is specified (Clear Anodized (-CA) is an option on the Post Metal Leg only)



GLASS TOP



D-SHAPE TOP

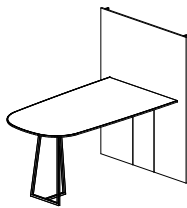
BASE KEY

OF	Open Frame	RCL	Laminate Racetrack Base
RCP		RCP	Painted Racetrack Base
RCV		RCV	Veneer Racetrack Base

D-SHAPE TOP // SLAB BASE // SEATED HEIGHT

MODEL #	LENGTH	WIDTH	HEIGHT	SEATING CAPACITY	-OF	-RCL	-RCP	-RCV
TFE-3060-G []	60	30	29-1/2	4	6,495	-	-	-
TFE-3066-G []	66	30	29-1/2	5	7,080	-	-	-
TFE-3072-G []	72	30	29-1/2	5	7,303	-	-	-
TFE-3078-G []	78	30	29-1/2	5	8,050	-	-	-
TFE-3084-G []	84	30	29-1/2	7	8,289	-	-	-
TFE-3090-G []	90	30	29-1/2	7	8,970	-	-	-
TFE-3096-G []	96	30	29-1/2	7	9,222	-	-	-
TFE-3660-G []	60	36	29-1/2	5	6,830	-	-	-
TFE-3666-G []	66	36	29-1/2	5	7,470	-	-	-
TFE-3672-G []	72	36	29-1/2	5	7,729	-	-	-
TFE-3678-G []	78	36	29-1/2	5	8,543	-	-	-
TFE-3684-G []	84	36	29-1/2	7	8,821	-	-	-
TFE-3690-G []	90	36	29-1/2	7	9,570	-	-	-
TFE-3696-G []	96	36	29-1/2	7	9,861	-	-	-
TFE-4260-G []	60	42	29-1/2	5	7,794	-	-	-
TFE-4266-G []	66	42	29-1/2	5	8,548	-	-	-
TFE-4272-G []	72	42	29-1/2	5	8,869	8,869	9,284	9,749
TFE-4278-G []	78	42	29-1/2	5	9,828	9,828	10,272	10,769
TFE-4284-G []	84	42	29-1/2	7	10,170	10,170	10,615	11,111
TFE-4290-G []	90	42	29-1/2	7	11,059	11,059	11,527	12,048
TFE-4296-G []	96	42	29-1/2	7	11,420	11,420	11,888	12,409
TFE-4860-G []	60	48	29-1/2	5	8,442	-	-	-
TFE-4866-G []	66	48	29-1/2	5	9,284	-	-	-
TFE-4872-G []	72	48	29-1/2	5	9,655	9,655	10,084	10,565
TFE-4878-G []	78	48	29-1/2	7	10,722	10,722	11,183	11,696
TFE-4884-G []	84	48	29-1/2	7	11,120	11,120	11,579	12,092
TFE-4890-G []	90	48	29-1/2	7	12,115	12,115	12,599	13,139
TFE-4896-G []	96	48	29-1/2	7	12,532	12,532	13,016	13,555

[] Slab Base, Specify Paint (-PS) or Veneer (-V)



Shown with optional Monitor Panel (-MP)

OPTIONS	CODE	PRICE	NOTES
Power & Data Options			See pages 112-122
Remove Slab Base	Add -WM	Deduct \$741	Mounted directly to wall
Polished Chrome Finish Options:			
Polished Chrome Open Frame Base	Add -PCOF-TWA	\$1,357	
Satin Glass Options:			
Satin Glass	Add -TFSG	\$691	
Monitor Panel Options:			
42"-Wide Monitor Panel	Add -MP30	\$2,201	For use with 30"-Wide Tables
48"-Wide Monitor Panel	Add -MP36	\$2,426	For use with 36"-Wide Tables
54"-Wide Monitor Panel	Add -MP42	\$2,653	For use with 42"-Wide Tables
60"-Wide Monitor Panel	Add -MP48	\$2,881	For use with 48"-Wide Tables

EDGE PROFILE



Two4Six Glass Edge

GENERAL INFORMATION

- Tops are 1-1/8"-thick with 3/16"-thick hardwood edge band
- Seating capacity based on 27" per person
- Overall table height 29.5"
- Standard with quarter cut veneer
- Must be anchored to a wall, with or without Slab Base
- One section of wire management channel provided per table
- Monitor Panel will be 12" wider than the table specified
- Monitor Panel mounts directly to the wall
- Monitor Panel is 78" high
- Monitor panel available in Paint or Veneer Finish options only
- Only Woodgrain Laminate options are available for the Racetrack Base
- Racetrack Bases have a removable access door

REQUIRED INFORMATION (ORDER CANNOT BE ENTERED WITHOUT THIS INFORMATION)

- See appendix pages vi-viii for surface material options.
- Choose Glass Finish
 - Choose Veneer Finish, if applicable
 - Choose Paint Finish if -PS Base is specified
 - Choose Metal Finish
 - Choose Solid Edge Band Finish or Coordinating Woodgrain Edge Band Finish, if -RCL Base specified
 - Choose Sub-Top Finish: Paint Finish or Wood Species & Finish



SOLID SURFACE TOP



D-SHAPE TOP

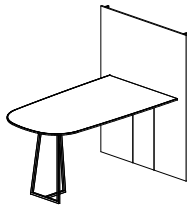
BASE KEY

OF	Open Frame	RCL	Laminate Racetrack Base
		RCP	Painted Racetrack Base
		RCV	Veneer Racetrack Base

D-SHAPE TOP // SLAB BASE // SEATED HEIGHT

MODEL #	LENGTH	WIDTH	HEIGHT	SEATING CAPACITY	-OF	-RCL	-RCP	-RCV
TFE-3060-SS []	60	30	29-1/2	4	6,786	-	-	-
TFE-3066-SS []	66	30	29-1/2	5	7,397	-	-	-
TFE-3072-SS []	72	30	29-1/2	5	7,631	-	-	-
TFE-3078-SS []	78	30	29-1/2	5	8,411	-	-	-
TFE-3084-SS []	84	30	29-1/2	7	8,661	-	-	-
TFE-3090-SS []	90	30	29-1/2	7	9,373	-	-	-
TFE-3096-SS []	96	30	29-1/2	7	9,635	-	-	-
TFE-3660-SS []	60	36	29-1/2	5	7,137	-	-	-
TFE-3666-SS []	66	36	29-1/2	5	7,805	-	-	-
TFE-3672-SS []	72	36	29-1/2	5	8,076	-	-	-
TFE-3678-SS []	78	36	29-1/2	5	8,926	-	-	-
TFE-3684-SS []	84	36	29-1/2	7	9,217	-	-	-
TFE-3690-SS []	90	36	29-1/2	7	9,999	-	-	-
TFE-3696-SS []	96	36	29-1/2	7	10,304	-	-	-
TFE-4260-SS []	60	42	29-1/2	5	8,144	-	-	-
TFE-4266-SS []	66	42	29-1/2	5	8,931	-	-	-
TFE-4272-SS []	72	42	29-1/2	5	9,267	9,267	9,701	10,186
TFE-4278-SS []	78	42	29-1/2	5	10,269	10,269	10,732	11,252
TFE-4284-SS []	84	42	29-1/2	7	10,626	10,626	11,091	11,609
TFE-4290-SS []	90	42	29-1/2	7	11,556	11,556	12,045	12,589
TFE-4296-SS []	96	42	29-1/2	7	11,932	11,932	12,421	12,966
TFE-4860-SS []	60	48	29-1/2	5	8,820	-	-	-
TFE-4866-SS []	66	48	29-1/2	5	9,701	-	-	-
TFE-4872-SS []	72	48	29-1/2	5	10,089	10,089	10,537	11,039
TFE-4878-SS []	78	48	29-1/2	7	11,203	11,203	11,684	12,221
TFE-4884-SS []	84	48	29-1/2	7	11,619	11,619	12,098	12,635
TFE-4890-SS []	90	48	29-1/2	7	12,659	12,659	13,164	13,728
TFE-4896-SS []	96	48	29-1/2	7	13,094	13,094	13,600	14,164

[] Slab Base, Specify Paint (-PS) or Veneer (-V)



Shown with optional Monitor Panel (-MP)

OPTIONS

OPTIONS	CODE	PRICE	NOTES
Power & Data Options			See pages 112-122
Remove Slab Base	Add -WM	Deduct \$741	Mounted directly to wall
Polished Chrome Finish Options:			
Polished Chrome Open Frame Base	Add -PCOF-TWA	\$1,357	
Monitor Panel Options:			
42"-Wide Monitor Panel	Add -MP30	\$2,201	For use with 30"-Wide Tables
48"-Wide Monitor Panel	Add -MP36	\$2,426	For use with 36"-Wide Tables
54"-Wide Monitor Panel	Add -MP42	\$2,653	For use with 42"-Wide Tables
60"-Wide Monitor Panel	Add -MP48	\$2,881	For use with 48"-Wide Tables

EDGE PROFILE



Two4Six Solid Surface Edge

GENERAL INFORMATION

- Seating capacity based on 27" per person
- Overall table height 29.5"
- Standard with quarter cut veneer
- Must be anchored to a wall, with or without Slab Base
- One section of wire management channel provided per table
- Monitor Panel will be 12" wider than the table specified
- Monitor Panel mounts directly to the wall
- Monitor Panel is 78" high
- Monitor panel available in Paint or Veneer Finish options only
- Only Woodgrain Laminate options are available for the Racetrack Base
- Racetrack Bases have a removable access door

REQUIRED INFORMATION (ORDER CANNOT BE ENTERED WITHOUT THIS INFORMATION)

See appendix pages vi-viii for surface material options.

- Choose Solid Surface Finish
- Choose Veneer Finish, if applicable
- Choose Paint Finish if -PS Base is specified
- Choose Metal Finish
- Choose Solid Edge Band Finish or Coordinating Woodgrain Edge Band Finish, if -RCL Base specified



VENEER TOP WITH HARDWOOD EDGE



D-SHAPE TOP

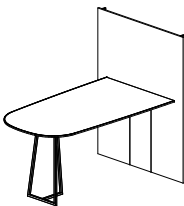
BASE KEY

OF	Open Frame	RCL	Laminate Racetrack Base
		RCP	Painted Racetrack Base
		RCV	Veneer Racetrack Base

D-SHAPE TOP // SLAB BASE // STANDING HEIGHT

MODEL #	LENGTH	WIDTH	HEIGHT	SEATING CAPACITY	-OF	-RCL	-RCP	-RCV []
TFN-3060-V []	60	30	42	5	4,384	-	-	-
TFN-3066-V []	66	30	42	5	4,771	-	-	-
TFN-3072-V []	72	30	42	5	4,915	-	-	-
TFN-3078-V []	78	30	42	5	5,409	-	-	-
TFN-3084-V []	84	30	42	7	5,562	-	-	-
TFN-3090-V []	90	30	42	7	6,013	-	-	-
TFN-3096-V []	96	30	42	7	6,174	-	-	-
TFN-3660-V []	60	36	42	5	4,599	-	-	-
TFN-3666-V []	66	36	42	5	5,021	-	-	-
TFN-3672-V []	72	36	42	5	5,188	-	-	-
TFN-3678-V []	78	36	42	5	5,725	-	-	-
TFN-3684-V []	84	36	42	7	5,903	-	-	-
TFN-3690-V []	90	36	42	7	6,397	-	-	-
TFN-3696-V []	96	36	42	7	6,584	-	-	-
TFN-4260-V []	60	42	42	5	5,236	-	-	-
TFN-4266-V []	66	42	42	5	5,733	-	-	-
TFN-4272-V []	72	42	42	5	5,939	5,939	6,387	6,772
TFN-4278-V []	78	42	42	5	6,571	6,571	7,050	7,462
TFN-4284-V []	84	42	42	7	6,790	6,790	7,269	7,681
TFN-4290-V []	90	42	42	7	7,375	7,375	7,878	8,312
TFN-4296-V []	96	42	42	7	7,606	7,606	8,109	8,543
TFN-4860-V []	60	48	42	5	5,659	-	-	-
TFN-4866-V []	66	48	42	5	6,213	-	-	-
TFN-4872-V []	72	48	42	5	6,451	6,451	6,915	7,313
TFN-4878-V []	78	48	42	5	7,154	7,154	7,649	8,076
TFN-4884-V []	84	48	42	7	7,408	7,408	7,904	8,330
TFN-4890-V []	90	48	42	7	8,061	8,061	8,582	9,031
TFN-4896-V []	96	48	42	7	8,328	8,328	8,850	9,298

[] Slab Base, Specify Paint (-PS) or Veneer (-V)

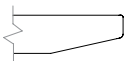


Shown with optional Monitor Panel (-MP)

OPTIONS

OPTIONS	CODE	PRICE	NOTES
Power & Data Options			See pages 112-122
Remove Slab Base	Add -WM	Deduct \$741	Mounted directly to wall
Polished Chrome Finish Options:			
Polished Chrome Open Frame Base	Add -PCOF-TWD	\$1,754	
Monitor Panel Options:			
42"-Wide Monitor Panel	Add -MP30	\$2,201	For use with 30"-Wide Tables
48"-Wide Monitor Panel	Add -MP36	\$2,426	For use with 36"-Wide Tables
54"-Wide Monitor Panel	Add -MP42	\$2,653	For use with 42"-Wide Tables
60"-Wide Monitor Panel	Add -MP48	\$2,881	For use with 48"-Wide Tables

EDGE PROFILE



Two4Six Cutback Edge

GENERAL INFORMATION

- Tops are 1-1/8"-thick with 3/16"-thick hardwood edge band
- Seating capacity based on 27" per person
- Overall table height 42"
- Standard with quarter cut veneer
- Must be anchored to a wall, with or without Slab Base
- One section of wire management channel provided per table
- Monitor Panel will be 12" wider than the table specified
- Monitor Panel mounts directly to the wall
- Monitor Panel is 78" high
- Not available with Power Matrix
- Only Woodgrain Laminate options are available for the Racetrack Base
- Racetrack Bases have a removable access door

REQUIRED INFORMATION (ORDER CANNOT BE ENTERED WITHOUT THIS INFORMATION)

- See appendix pages vi-viii for surface material options.
- Choose Veneer Finish. If -V option is specified for the Slab Base, the finish will be the same as the table top.
 - Choose Paint Finish, if -PS Slab Base is specified
 - Choose Metal Finish
 - Choose Solid Edge Band Finish or Coordinating Woodgrain Edge Band Finish, if -RCL Base specified



INSET LAMINATE TOP WITH HARDWOOD EDGE



D-SHAPE TOP

BASE KEY

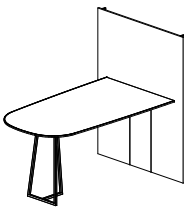
OF Open Frame

RCL Laminate Racetrack Base
RCP Painted Racetrack Base
RCV Veneer Racetrack Base

D-SHAP [] E TOP [] // SLAB BASE // STANDING HEIGHT

MODEL #	LENGTH	WIDTH	HEIGHT	SEATING CAP []ACITY	-OF	-RCL	-RCP []	-RCV
TFN-3060-P []	60	30	42	5	4,143	-	-	-
TFN-3066-P []	66	30	42	5	4,509	-	-	-
TFN-3072-P []	72	30	42	5	4,645	-	-	-
TFN-3078-P []	78	30	42	5	5,112	-	-	-
TFN-3084-P []	84	30	42	7	5,257	-	-	-
TFN-3090-P []	90	30	42	7	5,683	-	-	-
TFN-3096-P []	96	30	42	7	5,835	-	-	-
TFN-3660-P []	60	36	42	5	4,347	-	-	-
TFN-3666-P []	66	36	42	5	4,745	-	-	-
TFN-3672-P []	72	36	42	5	4,903	-	-	-
TFN-3678-P []	78	36	42	5	5,411	-	-	-
TFN-3684-P []	84	36	42	7	5,579	-	-	-
TFN-3690-P []	90	36	42	7	6,046	-	-	-
TFN-3696-P []	96	36	42	7	6,222	-	-	-
TFN-4260-P []	60	42	42	5	4,949	-	-	-
TFN-4266-P []	66	42	42	5	5,418	-	-	-
TFN-4272-P []	72	42	42	5	5,613	5,613	6,036	6,400
TFN-4278-P []	78	42	42	5	6,210	6,210	6,663	7,052
TFN-4284-P []	84	42	42	7	6,417	6,417	6,870	7,259
TFN-4290-P []	90	42	42	7	6,970	6,970	7,445	7,855
TFN-4296-P []	96	42	42	7	7,188	7,188	7,664	8,074
TFN-4860-P []	60	48	42	5	5,348	-	-	-
TFN-4866-P []	66	48	42	5	5,872	-	-	-
TFN-4872-P []	72	48	42	5	6,097	6,097	6,535	6,911
TFN-4878-P []	78	48	42	5	6,761	6,761	7,229	7,632
TFN-4884-P []	84	48	42	7	7,001	7,001	7,470	7,872
TFN-4890-P []	90	48	42	7	7,618	7,618	8,110	8,535
TFN-4896-P []	96	48	42	7	7,870	7,870	8,364	8,787

[] Slab Base, Specify Paint (-PS) or Veneer (-V)

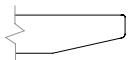


Shown with optional Monitor Panel (-MP)

OPTIONS

OPTIONS	CODE	PRICE	NOTES
Power & Data Options			See pages 112-122
Remove Slab Base	Add -WM	Deduct \$741	Mounted directly to wall
Polished Chrome Finish Options:			
Polished Chrome Open Frame Base	Add -PCOF-TWD	\$1,754	
Monitor Panel Options:			
42"-Wide Monitor Panel	Add -MP30	\$2,201	For use with 30"-Wide Tables
48"-Wide Monitor Panel	Add -MP36	\$2,426	For use with 36"-Wide Tables
54"-Wide Monitor Panel	Add -MP42	\$2,653	For use with 42"-Wide Tables
60"-Wide Monitor Panel	Add -MP48	\$2,881	For use with 48"-Wide Tables

EDGE PROFILE



Two4Six Cutback Edge

GENERAL INFORMATION

- Tops are 1-1/8"-thick with 3/16"-thick hardwood edge band
- Seating capacity based on 27" per person
- Overall table height 42"
- Standard with quarter cut veneer
- Must be anchored to a wall, with or without Slab Base
- One section of wire management channel provided per table
- Monitor Panel will be 12" wider than the table specified
- Monitor Panel mounts directly to the wall
- Monitor Panel is 78" high
- Monitor panel available in Paint or Veneer Finish options only
- Not available with Power Matrix
- Only Woodgrain Laminate options are available for the Racetrack Base
- Racetrack Bases have a removable access door

REQUIRED INFORMATION (ORDER CANNOT BE ENTERED WITHOUT THIS INFORMATION)

See appendix pages vi-viii for surface material options.

- Choose Laminate Finish
- Choose Wood Species & Finish for Hardwood Edge
- Choose Metal Finish
- Choose Paint Finish, if -PS Slab Base is specified
- Choose Veneer Finish, if -V Slab Base is specified
- Choose Solid Edge Band Finish or Coordinating Woodgrain Edge Band Finish, if -RCL Base specified



LAMINATE TOP WITH CUTBACK EDGE



D-SHAPE TOP

BASE KEY

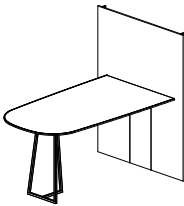
OF Open Frame

RCL Laminate Racetrack Base
RCP Painted Racetrack Base
RCV Veneer Racetrack Base

D-SHAPE TOP // SLAB BASE // STANDING HEIGHT

MODEL #	LENGTH	WIDTH	HEIGHT	SEATING CAPACITY	-OF	-RCL	-RCP	-RCV
TFN-3060-PA []	60	30	42	5	4,143	-	-	-
TFN-3066-PA []	66	30	42	5	4,509	-	-	-
TFN-3072-PA []	72	30	42	5	4,645	-	-	-
TFN-3078-PA []	78	30	42	5	5,112	-	-	-
TFN-3084-PA []	84	30	42	7	5,257	-	-	-
TFN-3090-PA []	90	30	42	7	5,683	-	-	-
TFN-3096-PA []	96	30	42	7	5,835	-	-	-
TFN-3660-PA []	60	36	42	5	4,347	-	-	-
TFN-3666-PA []	66	36	42	5	4,745	-	-	-
TFN-3672-PA []	72	36	42	5	4,903	-	-	-
TFN-3678-PA []	78	36	42	5	5,411	-	-	-
TFN-3684-PA []	84	36	42	7	5,579	-	-	-
TFN-3690-PA []	90	36	42	7	6,046	-	-	-
TFN-3696-PA []	96	36	42	7	6,222	-	-	-
TFN-4260-PA []	60	42	42	5	4,949	-	-	-
TFN-4266-PA []	66	42	42	5	5,418	-	-	-
TFN-4272-PA []	72	42	42	5	5,613	5,613	6,036	6,400
TFN-4278-PA []	78	42	42	5	6,210	6,210	6,663	7,052
TFN-4284-PA []	84	42	42	7	6,417	6,417	6,870	7,259
TFN-4290-PA []	90	42	42	7	6,970	6,970	7,445	7,855
TFN-4296-PA []	96	42	42	7	7,188	7,188	7,664	8,074
TFN-4860-PA []	60	48	42	5	5,348	-	-	-
TFN-4866-PA []	66	48	42	5	5,872	-	-	-
TFN-4872-PA []	72	48	42	5	6,097	6,097	6,535	6,911
TFN-4878-PA []	78	48	42	5	6,761	6,761	7,229	7,632
TFN-4884-PA []	84	48	42	7	7,001	7,001	7,470	7,872
TFN-4890-PA []	90	48	42	7	7,618	7,618	8,110	8,535
TFN-4896-PA []	96	48	42	7	7,870	7,870	8,364	8,787

[] Slab Base, Specify Paint (-PS) or Veneer (-V)

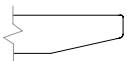


Shown with optional Monitor Panel (-MP)

OPTIONS

OPTIONS	CODE	PRICE	NOTES
Power & Data Options			See pages 112-122
Remove Slab Base	Add -WM	Deduct \$741	Mounted directly to wall
Polished Chrome Finish Options:			
Polished Chrome Open Frame Base	Add -PCOF-TWD	\$1,754	
Monitor Panel Options:			
42"-Wide Monitor Panel	Add -MP30	\$2,201	For use with 30"-Wide Tables
48"-Wide Monitor Panel	Add -MP36	\$2,426	For use with 36"-Wide Tables
54"-Wide Monitor Panel	Add -MP42	\$2,653	For use with 42"-Wide Tables
60"-Wide Monitor Panel	Add -MP48	\$2,881	For use with 48"-Wide Tables

EDGE PROFILE



Two4Six Cutback Edge

GENERAL INFORMATION

- Tops are 1-1/8"-thick
- Seating capacity based on 27" per person
- Overall table height 42"
- Standard with quarter cut veneer
- Must be anchored to a wall, with or without Slab Base
- One section of wire management channel provided per table
- Monitor Panel will be 12" wider than the table specified
- Monitor Panel mounts directly to the wall
- Monitor Panel is 78" high
- Monitor panel available in Paint or Veneer Finish options only
- Not available with Power Matrix
- Only Woodgrain Laminate options are available for the Racetrack Base
- Racetrack Bases have a removable access door

REQUIRED INFORMATION (ORDER CANNOT BE ENTERED WITHOUT THIS INFORMATION)

- See appendix pages vi-viii for surface material options.
- Choose Laminate Finish
 - Choose Solid Edge Band Finish or Coordinating Woodgrain Edge Band Finish
 - Choose Metal Finish
 - Choose Paint Finish, if -PS Slab Base is specified
 - Choose Veneer Finish, if -V Slab Base is specified



LAMINATE TOP WITH SQUARE EDGE



D-SHAPE TOP

BASE KEY

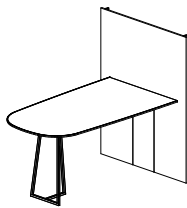
OF Open Frame

RCL Laminate Racetrack Base
RCP Painted Racetrack Base
RCV Veneer Racetrack Base

D-SHAPE TOP // SLAB BASE // STANDING HEIGHT

MODEL #	LENGTH	WIDTH	HEIGHT	SEATING CAPACITY	-OF	-RCL	-RCP	-RCV
TFN-3060-PE []	60	30	42	5	3,937	-	-	-
TFN-3066-PE []	66	30	42	5	4,285	-	-	-
TFN-3072-PE []	72	30	42	5	4,414	-	-	-
TFN-3078-PE []	78	30	42	5	4,858	-	-	-
TFN-3084-PE []	84	30	42	7	4,995	-	-	-
TFN-3090-PE []	90	30	42	7	5,400	-	-	-
TFN-3096-PE []	96	30	42	7	5,545	-	-	-
TFN-3660-PE []	60	36	42	5	4,130	-	-	-
TFN-3666-PE []	66	36	42	5	4,509	-	-	-
TFN-3672-PE []	72	36	42	5	4,659	-	-	-
TFN-3678-PE []	78	36	42	5	5,142	-	-	-
TFN-3684-PE []	84	36	42	7	5,301	-	-	-
TFN-3690-PE []	90	36	42	7	5,745	-	-	-
TFN-3696-PE []	96	36	42	7	5,913	-	-	-
TFN-4260-PE []	60	42	42	5	4,702	-	-	-
TFN-4266-PE []	66	42	42	5	5,149	-	-	-
TFN-4272-PE []	72	42	42	5	5,334	5,334	5,736	6,082
TFN-4278-PE []	78	42	42	5	5,901	5,901	6,331	6,701
TFN-4284-PE []	84	42	42	7	6,098	6,098	6,528	6,898
TFN-4290-PE []	90	42	42	7	6,623	6,623	7,075	7,465
TFN-4296-PE []	96	42	42	7	6,831	6,831	7,282	7,672
TFN-4860-PE []	60	48	42	5	5,082	-	-	-
TFN-4866-PE []	66	48	42	5	5,580	-	-	-
TFN-4872-PE []	72	48	42	5	5,793	5,793	6,210	6,568
TFN-4878-PE []	78	48	42	5	6,425	6,425	6,869	7,253
TFN-4884-PE []	84	48	42	7	6,653	6,653	7,098	7,481
TFN-4890-PE []	90	48	42	7	7,239	7,239	7,707	8,110
TFN-4896-PE []	96	48	42	7	7,479	7,479	7,948	8,350

[] Slab Base, Specify Paint (-PS) or Veneer (-V)



Shown with optional Monitor Panel (-MP)

OPTIONS

Power & Data Options

CODE

PRICE

NOTES

See pages 112-122

Remove Slab Base

Add **-WM**

Deduct \$741

Mounted directly to wall

Polished Chrome Finish Options:

Polished Chrome Open Frame Base

Add **-PCOF-TWD**

\$1,754

Monitor Panel Options:

42"-Wide Monitor Panel

Add **-MP30**

\$2,201

For use with 30"-Wide Tables

48"-Wide Monitor Panel

Add **-MP36**

\$2,426

For use with 36"-Wide Tables

54"-Wide Monitor Panel

Add **-MP42**

\$2,653

For use with 42"-Wide Tables

60"-Wide Monitor Panel

Add **-MP48**

\$2,881

For use with 48"-Wide Tables

EDGE PROFILE



Two4Six Square Edge

GENERAL INFORMATION

- Tops are 1-1/8"-thick
- Seating capacity based on 27" per person
- Overall table height 42"
- Standard with quarter cut veneer
- Must be anchored to a wall, with or without Slab Base
- One section of wire management channel provided per table
- Monitor Panel will be 12" wider than the table specified

- Monitor Panel mounts directly to the wall
- Monitor Panel is 78" high
- Monitor panel available in Paint or Veneer Finish options only
- Not available with Power Matrix
- Only Woodgrain Laminate options are available for the Racetrack Base
- Racetrack Bases have a removable access door

REQUIRED INFORMATION (ORDER CANNOT BE ENTERED WITHOUT THIS INFORMATION)

See appendix pages vi-viii for surface material options.

- Choose Laminate Finish
- Choose Solid Edge Band Finish or Coordinating Woodgrain Edge Band Finish
- Choose Metal Finish
- Choose Paint Finish, if -PS Slab Base is specified
- Choose Veneer Finish, if -V Slab Base is specified



GLASS TOP



D-SHAPE TOP

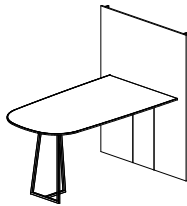
BASE KEY

OF	Open Frame	RCL	Laminate Racetrack Base
RCP		RCP	Painted Racetrack Base
RCV		RCV	Veneer Racetrack Base

D-SHAPE TOP // SLAB BASE // STANDING HEIGHT

MODEL #	LENGTH	WIDTH	HEIGHT	SEATING CAPACITY	-OF	-RCL	-RCP	-RCV
TFN-3060-G []	60	30	42	5	6,840	-	-	-
TFN-3066-G []	66	30	42	5	7,443	-	-	-
TFN-3072-G []	72	30	42	5	7,668	-	-	-
TFN-3078-G []	78	30	42	5	8,439	-	-	-
TFN-3084-G []	84	30	42	7	8,677	-	-	-
TFN-3090-G []	90	30	42	7	9,381	-	-	-
TFN-3096-G []	96	30	42	7	9,632	-	-	-
TFN-3660-G []	60	36	42	5	7,175	-	-	-
TFN-3666-G []	66	36	42	5	7,833	-	-	-
TFN-3672-G []	72	36	42	5	8,094	-	-	-
TFN-3678-G []	78	36	42	5	8,931	-	-	-
TFN-3684-G []	84	36	42	7	9,209	-	-	-
TFN-3690-G []	90	36	42	7	9,980	-	-	-
TFN-3696-G []	96	36	42	7	10,272	-	-	-
TFN-4260-G []	60	42	42	5	8,169	-	-	-
TFN-4266-G []	66	42	42	5	8,944	-	-	-
TFN-4272-G []	72	42	42	5	9,265	9,265	9,964	10,565
TFN-4278-G []	78	42	42	5	10,251	10,251	10,998	11,641
TFN-4284-G []	84	42	42	7	10,593	10,593	11,340	11,983
TFN-4290-G []	90	42	42	7	11,505	11,505	12,290	12,967
TFN-4296-G []	96	42	42	7	11,866	11,866	12,651	13,328
TFN-4860-G []	60	48	42	5	8,829	-	-	-
TFN-4866-G []	66	48	42	5	9,693	-	-	-
TFN-4872-G []	72	48	42	5	10,064	10,064	10,788	11,409
TFN-4878-G []	78	48	42	5	11,161	11,161	11,933	12,599
TFN-4884-G []	84	48	42	7	11,557	11,557	12,331	12,995
TFN-4890-G []	90	48	42	7	12,576	12,576	13,388	14,089
TFN-4896-G []	96	48	42	7	12,992	12,992	13,806	14,505

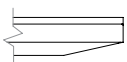
[] Slab Base, Specify Paint (-PS) or Veneer (-V)



Shown with optional Monitor Panel (-MP)

OPTIONS	CODE	PRICE	NOTES
Power & Data Options			See pages 112-122
Remove Slab Base	Add -WM	Deduct \$741	Mounted directly to wall
Polished Chrome Finish Options:			
Polished Chrome Open Frame Base	Add -PCOF-TWD	\$1,754	
Satin Glass Options:			
Satin Glass	Add -TFSG	\$691	
Monitor Panel Options:			
42"-Wide Monitor Panel	Add -MP30	\$2,201	For use with 30"-Wide Tables
48"-Wide Monitor Panel	Add -MP36	\$2,426	For use with 36"-Wide Tables
54"-Wide Monitor Panel	Add -MP42	\$2,653	For use with 42"-Wide Tables
60"-Wide Monitor Panel	Add -MP48	\$2,881	For use with 48"-Wide Tables

EDGE PROFILE



Two4Six Glass Edge

GENERAL INFORMATION

- Tops are 1-1/8"-thick with 3/16"-thick hardwood edge band
- Seating capacity based on 27" per person
- Overall table height 42"
- Standard with quarter cut veneer
- Must be anchored to a wall, with or without Slab Base
- One section of wire management channel provided per table
- Monitor Panel will be 12" wider than the table specified
- Monitor Panel mounts directly to the wall
- Monitor Panel is 78" high
- Monitor panel available in Paint or Veneer Finish options only
- Not available with Power Matrix
- Only Woodgrain Laminate options are available for the Racetrack Base
- Racetrack Bases have a removable access door

REQUIRED INFORMATION (ORDER CANNOT BE ENTERED WITHOUT THIS INFORMATION)

See appendix pages vi-viii for surface material options.

- Choose Glass Finish
- Choose Paint Finish, if -PS Slab Base is specified
- Choose Veneer Finish, if -V Slab Base is specified
- Choose Metal Finish
- Choose Solid Edge Band Finish or Coordinating Woodgrain Edge Band Finish, if -RCL Base specified
- Choose Sub-Top Finish: Paint Finish or Wood Species & Finish



SOLID SURFACE TOP



D-SHAPE TOP

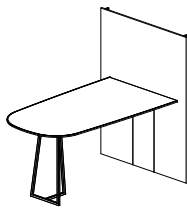
BASE KEY

OF	Open Frame	RCL	Laminate Racetrack Base
		RCP	Painted Racetrack Base
		RCV	Veneer Racetrack Base

D-SHAPE TOP // SLAB BASE // STANDING HEIGHT

MODEL #	LENGTH	WIDTH	HEIGHT	SEATING CAPACITY	-OF	-RCL	-RCP	-RCV
TFN-3060-SS []	60	30	42	5	7,146	-	-	-
TFN-3066-SS []	66	30	42	5	7,777	-	-	-
TFN-3072-SS []	72	30	42	5	8,012	-	-	-
TFN-3078-SS []	78	30	42	5	8,817	-	-	-
TFN-3084-SS []	84	30	42	7	9,067	-	-	-
TFN-3090-SS []	90	30	42	7	9,802	-	-	-
TFN-3096-SS []	96	30	42	7	10,064	-	-	-
TFN-3660-SS []	60	36	42	5	7,497	-	-	-
TFN-3666-SS []	66	36	42	5	8,185	-	-	-
TFN-3672-SS []	72	36	42	5	8,457	-	-	-
TFN-3678-SS []	78	36	42	5	9,332	-	-	-
TFN-3684-SS []	84	36	42	7	9,622	-	-	-
TFN-3690-SS []	90	36	42	7	10,428	-	-	-
TFN-3696-SS []	96	36	42	7	10,732	-	-	-
TFN-4260-SS []	60	42	42	5	8,535	-	-	-
TFN-4266-SS []	66	42	42	5	9,345	-	-	-
TFN-4272-SS []	72	42	42	5	9,681	9,681	10,411	11,039
TFN-4278-SS []	78	42	42	5	10,711	10,711	11,492	12,164
TFN-4284-SS []	84	42	42	7	11,068	11,068	11,849	12,521
TFN-4290-SS []	90	42	42	7	12,022	12,022	12,842	13,549
TFN-4296-SS []	96	42	42	7	12,398	12,398	13,218	13,926
TFN-4860-SS []	60	48	42	5	9,225	-	-	-
TFN-4866-SS []	66	48	42	5	10,128	-	-	-
TFN-4872-SS []	72	48	42	5	10,516	10,516	11,272	11,921
TFN-4878-SS []	78	48	42	5	11,662	11,662	12,468	13,164
TFN-4884-SS []	84	48	42	7	12,076	12,076	12,884	13,578
TFN-4890-SS []	90	48	42	7	13,140	13,140	13,989	14,721
TFN-4896-SS []	96	48	42	7	13,575	13,575	14,426	15,156

[] Slab Base, Specify Paint (-PS) or Veneer (-V)



Shown with optional Monitor Panel (-MP)

OPTIONS

Power & Data Options

CODE

PRICE

NOTES

See pages 112-122

Remove Slab Base

Add **-WM**

Deduct \$741

Mounted directly to wall

Polished Chrome Finish Options:

Polished Chrome Open Frame Base

Add **-PCOF-TWD**

\$1,754

Monitor Panel Options:

42"-Wide Monitor Panel

Add **-MP30**

\$2,201

For use with 30"-Wide Tables

48"-Wide Monitor Panel

Add **-MP36**

\$2,426

For use with 36"-Wide Tables

54"-Wide Monitor Panel

Add **-MP42**

\$2,653

For use with 42"-Wide Tables

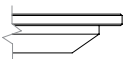
60"-Wide Monitor Panel

Add **-MP48**

\$2,881

For use with 48"-Wide Tables

EDGE PROFILE



Two4Six Solid Surface Edge

GENERAL INFORMATION

- Seating capacity based on 27" per person
- Overall table height 42"
- Standard with quarter cut veneer
- Must be anchored to a wall, with or without Slab Base
- One section of wire management channel provided per table
- Monitor Panel will be 12" wider than the table specified

- Monitor Panel mounts directly to the wall
- Monitor Panel is 78" high
- Monitor panel available in Paint or Veneer Finish options only
- Not available with Power Matrix
- Only Woodgrain Laminate options are available for the Racetrack Base
- Racetrack Bases have a removable access door

REQUIRED INFORMATION (ORDER CANNOT BE ENTERED WITHOUT THIS INFORMATION)

See appendix pages vi-viii for surface material options.

- Choose Solid Surface Finish
- Choose Paint Finish, if -PS Slab Base is specified
- Choose Veneer Finish, if -V Slab Base is specified
- Choose Metal Finish
- Choose Solid Edge Band Finish or Coordinating Woodgrain Edge Band Finish, if -RCL Base specified



VENEER TOP WITH HARDWOOD EDGE



RECTANGLE TOP

BASE KEY

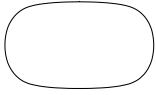
- OF Open Frame
- RCL Laminate Racetrack Base
- RCP Painted Racetrack Base
- RCV Veneer Racetrack Base

RECTANGLE TOP TABLES

MODEL #	LENGTH	WIDTH	HEIGHT	SEATING CAPACITY	-OF	-RCL	-RCP	-RCV
TFP-3060-V	60	30	42	4	4,613	-	-	-
TFP-3660-V	60	36	42	4	4,828	-	-	-
TFP-4260-V	60	42	42	4	5,485	-	-	-
TFP-4860-V	60	48	42	4	5,917	-	-	-
TFP-3066-V	66	30	42	4	5,013	-	-	-
TFP-3666-V	66	36	42	4	5,263	-	-	-
TFP-4266-V	66	42	42	4	5,996	-	-	-
TFP-4866-V	66	48	42	4	6,485	-	-	-
TFP-3072-V	72	30	42	6	5,157	-	-	-
TFP-3672-V	72	36	42	6	5,430	-	-	-
TFP-4272-V	72	42	42	6	6,202	6,202	6,628	7,066
TFP-4872-V	72	48	42	6	6,723	6,723	7,164	7,618
TFP-3078-V	78	30	42	6	5,668	-	-	-
TFP-3678-V	78	36	42	6	5,984	-	-	-
TFP-4278-V	78	42	42	6	6,852	6,852	7,308	7,777
TFP-4878-V	78	48	42	6	7,445	7,445	7,916	8,401
TFP-3084-V	84	30	42	8	5,821	-	-	-
TFP-3684-V	84	36	42	8	6,162	-	-	-
TFP-4284-V	84	42	42	8	7,072	7,072	7,527	7,996
TFP-4884-V	84	48	42	8	7,699	7,699	8,171	8,656
TFP-3090-V	90	30	42	8	6,285	-	-	-
TFP-3690-V	90	36	42	8	6,669	-	-	-
TFP-4290-V	90	42	42	8	7,671	7,671	8,150	8,643
TFP-4890-V	90	48	42	8	8,367	8,367	8,863	9,373
TFP-3096-V	96	30	42	8	6,446	-	-	-
TFP-3696-V	96	36	42	8	6,856	-	-	-
TFP-4296-V	96	42	42	8	7,902	7,902	8,381	8,874
TFP-4896-V	96	48	42	8	8,635	8,635	9,130	9,641
TFP-42102-V	102	42	42	8	-	8,584	9,090	9,611
TFP-48102-V	102	48	42	8	-	9,397	9,920	10,459
TFP-42108-V	108	42	42	10	-	8,828	9,334	9,855
TFP-48108-V	108	48	42	10	-	9,680	10,203	10,741
TFP-42114-V	114	42	42	10	-	9,549	10,081	10,630
TFP-48114-V	114	48	42	10	-	10,487	11,038	11,605
TFP-42120-V	120	42	42	10	-	9,806	10,338	10,887
TFP-48120-V	120	48	42	10	-	10,785	11,336	11,903
TFP-42132-V	132	42	42	10	-	10,749	11,303	11,874
TFP-48132-V	132	48	42	10	-	11,854	12,428	13,019
TFP-42144-V	144	42	42	12	-	11,735	12,312	12,906
TFP-48144-V	144	48	42	12	-	12,973	13,569	14,183



VENEER TOP WITH HARDWOOD EDGE



SOFT RECTANGLE TOP

BASE KEY

- OF Open Frame
- RCL Laminate Racetrack Base
- RCP Painted Racetrack Base
- RCV Veneer Racetrack Base

SOFT RECTANGLE TOP TABLES

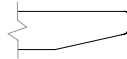
MODEL #	LENGTH	WIDTH	HEIGHT	SEATING CAPACITY	-OF	-RCL	-RCP	-RCV
TFV-3060-V	60	30	42	4	4,613	-	-	-
TFV-3660-V	60	36	42	4	4,828	-	-	-
TFV-4260-V	60	42	42	4	5,485	-	-	-
TFV-4860-V	60	48	42	4	5,917	-	-	-
TFV-3066-V	66	30	42	4	5,013	-	-	-
TFV-3666-V	66	36	42	4	5,263	-	-	-
TFV-4266-V	66	42	42	4	5,996	-	-	-
TFV-4866-V	66	48	42	4	6,485	-	-	-
TFV-3072-V	72	30	42	6	5,157	-	-	-
TFV-3672-V	72	36	42	6	5,430	-	-	-
TFV-4272-V	72	42	42	6	6,202	6,202	6,628	7,066
TFV-4872-V	72	48	42	6	6,723	6,723	7,164	7,618
TFV-3078-V	78	30	42	6	5,668	-	-	-
TFV-3678-V	78	36	42	6	5,984	-	-	-
TFV-4278-V	78	42	42	6	6,852	6,852	7,308	7,777
TFV-4878-V	78	48	42	6	7,445	7,445	7,916	8,401
TFV-3084-V	84	30	42	8	5,821	-	-	-
TFV-3684-V	84	36	42	8	6,162	-	-	-
TFV-4284-V	84	42	42	8	7,072	7,072	7,527	7,996
TFV-4884-V	84	48	42	8	7,699	7,699	8,171	8,656
TFV-3090-V	90	30	42	8	6,285	-	-	-
TFV-3690-V	90	36	42	8	6,669	-	-	-
TFV-4290-V	90	42	42	8	7,671	7,671	8,150	8,643
TFV-4890-V	90	48	42	8	8,367	8,367	8,863	9,373
TFV-3096-V	96	30	42	8	6,446	-	-	-
TFV-3696-V	96	36	42	8	6,856	-	-	-
TFV-4296-V	96	42	42	8	7,902	7,902	8,381	8,874
TFV-4896-V	96	48	42	8	8,635	8,635	9,130	9,641
TFV-42102-V	102	42	42	8	-	8,584	9,090	9,611
TFV-48102-V	102	48	42	8	-	9,397	9,920	10,459
TFV-42108-V	108	42	42	10	-	8,828	9,334	9,855
TFV-48108-V	108	48	42	10	-	9,680	10,203	10,741
TFV-42114-V	114	42	42	10	-	9,549	10,081	10,630
TFV-48114-V	114	48	42	10	-	10,487	11,038	11,605
TFV-42120-V	120	42	42	10	-	9,806	10,338	10,887
TFV-48120-V	120	48	42	10	-	10,785	11,336	11,903
TFV-42132-V	132	42	42	10	-	10,749	11,303	11,874
TFV-48132-V	132	48	42	10	-	11,854	12,428	13,019
TFV-42144-V	144	42	42	12	-	11,735	12,312	12,906
TFV-48144-V	144	48	42	12	-	12,973	13,569	14,183



VENEER TOP WITH HARDWOOD EDGE

OPTIONS	CODE	PRICE	NOTES
Power & Data Options			See pages 112-122
Polished Chrome Finish Options:			
Polished Chrome Open Frame Base	Add -PCOF-TWE	\$2,881	
Multi-Section Tops:			
102", 108", 114" and 120" one-piece tops split into two sections	Specify -2	\$843	Note: Power Matrix (center of table location only) cannot be specified when this option is selected

EDGE PROFILE



Two4Six Cutback Edge

GENERAL INFORMATION

- Seating capacity based on 27" per person
- Overall table height 42"
- Standard with quarter cut veneer
- One section of wire management channel provided per table
- Racetrack Bases have a removable access door

REQUIRED INFORMATION (ORDER CANNOT BE ENTERED WITHOUT THIS INFORMATION)

See appendix pages vi-viii for surface material options.

- Choose Veneer Finish
- Choose Metal Finish
- Choose Solid Edge Band Finish or Coordinating Woodgrain Edge Band Finish, if -RCL Base specified



INSET LAMINATE TOP WITH HARDWOOD EDGE



RECTANGLE TOP

BASE KEY

OF Open Frame

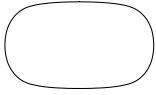
RCL Laminate Racetrack Base
 RCP Painted Racetrack Base
 RCV Veneer Racetrack Base

RECTANGLE TOP TABLES

MODEL #	LENGTH	WIDTH	HEIGHT	SEATING CAPACITY	-OF	-RCL	-RCP	-RCV
TFP-3060-P	60	30	42	4	4,360	-	-	-
TFP-3660-P	60	36	42	4	4,563	-	-	-
TFP-4260-P	60	42	42	4	5,184	-	-	-
TFP-4860-P	60	48	42	4	5,592	-	-	-
TFP-3066-P	66	30	42	4	4,738	-	-	-
TFP-3666-P	66	36	42	4	4,974	-	-	-
TFP-4266-P	66	42	42	4	5,667	-	-	-
TFP-4866-P	66	48	42	4	6,129	-	-	-
TFP-3072-P	72	30	42	6	4,874	-	-	-
TFP-3672-P	72	36	42	6	5,132	-	-	-
TFP-4272-P	72	42	42	6	5,861	5,861	6,264	6,678
TFP-4872-P	72	48	42	6	6,354	6,354	6,770	7,200
TFP-3078-P	78	30	42	6	5,357	-	-	-
TFP-3678-P	78	36	42	6	5,655	-	-	-
TFP-4278-P	78	42	42	6	6,476	6,476	6,907	7,350
TFP-4878-P	78	48	42	6	7,036	7,036	7,481	7,939
TFP-3084-P	84	30	42	8	5,501	-	-	-
TFP-3684-P	84	36	42	8	5,824	-	-	-
TFP-4284-P	84	42	42	8	6,684	6,684	7,114	7,557
TFP-4884-P	84	48	42	8	7,276	7,276	7,722	8,180
TFP-3090-P	90	30	42	8	5,940	-	-	-
TFP-3690-P	90	36	42	8	6,303	-	-	-
TFP-4290-P	90	42	42	8	7,250	7,250	7,702	8,168
TFP-4890-P	90	48	42	8	7,907	7,907	8,376	8,858
TFP-3096-P	96	30	42	8	6,092	-	-	-
TFP-3696-P	96	36	42	8	6,479	-	-	-
TFP-4296-P	96	42	42	8	7,468	7,468	7,921	8,386
TFP-4896-P	96	48	42	8	8,161	8,161	8,628	9,111
TFP-42102-P	102	42	42	8	-	8,112	8,591	9,083
TFP-48102-P	102	48	42	8	-	8,881	9,375	9,884
TFP-42108-P	108	42	42	10	-	8,343	8,821	9,313
TFP-48108-P	108	48	42	10	-	9,148	9,642	10,151
TFP-42114-P	114	42	42	10	-	9,024	9,527	10,046
TFP-48114-P	114	48	42	10	-	9,911	10,431	10,967
TFP-42120-P	120	42	42	10	-	9,267	9,770	10,289
TFP-48120-P	120	48	42	10	-	10,192	10,713	11,249
TFP-42132-P	132	42	42	10	-	10,158	10,682	11,221
TFP-48132-P	132	48	42	10	-	11,203	11,745	12,303
TFP-42144-P	144	42	42	12	-	11,090	11,635	12,197
TFP-48144-P	144	48	42	12	-	12,260	12,823	13,403



INSET LAMINATE TOP WITH HARDWOOD EDGE



SOFT RECTANGLE TOP

BASE KEY

OF Open Frame

RCL Laminate Racetrack Base
 RCP Painted Racetrack Base
 RCV Veneer Racetrack Base

SOFT RECTANGLE TOP TABLES

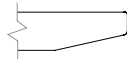
MODEL #	LENGTH	WIDTH	HEIGHT	SEATING CAPACITY	-OF	-RCL	-RCP	-RCV
TFV-3060-P	60	30	42	4	4,360	-	-	-
TFV-3660-P	60	36	42	4	4,563	-	-	-
TFV-4260-P	60	42	42	4	5,184	-	-	-
TFV-4860-P	60	48	42	4	5,592	-	-	-
TFV-3066-P	66	30	42	4	4,738	-	-	-
TFV-3666-P	66	36	42	4	4,974	-	-	-
TFV-4266-P	66	42	42	4	5,667	-	-	-
TFV-4866-P	66	48	42	4	6,129	-	-	-
TFV-3072-P	72	30	42	6	4,874	-	-	-
TFV-3672-P	72	36	42	6	5,132	-	-	-
TFV-4272-P	72	42	42	6	5,861	5,861	6,264	6,678
TFV-4872-P	72	48	42	6	6,354	6,354	6,770	7,200
TFV-3078-P	78	30	42	6	5,357	-	-	-
TFV-3678-P	78	36	42	6	5,655	-	-	-
TFV-4278-P	78	42	42	6	6,476	6,476	6,907	7,350
TFV-4878-P	78	48	42	6	7,036	7,036	7,481	7,939
TFV-3084-P	84	30	42	8	5,501	-	-	-
TFV-3684-P	84	36	42	8	5,824	-	-	-
TFV-4284-P	84	42	42	8	6,684	6,684	7,114	7,557
TFV-4884-P	84	48	42	8	7,276	7,276	7,722	8,180
TFV-3090-P	90	30	42	8	5,940	-	-	-
TFV-3690-P	90	36	42	8	6,303	-	-	-
TFV-4290-P	90	42	42	8	7,250	7,250	7,702	8,168
TFV-4890-P	90	48	42	8	7,907	7,907	8,376	8,858
TFV-3096-P	96	30	42	8	6,092	-	-	-
TFV-3696-P	96	36	42	8	6,479	-	-	-
TFV-4296-P	96	42	42	8	7,468	7,468	7,921	8,386
TFV-4896-P	96	48	42	8	8,161	8,161	8,628	9,111
TFV-42102-P	102	42	42	8	-	8,112	8,591	9,083
TFV-48102-P	102	48	42	8	-	8,881	9,375	9,884
TFV-42108-P	108	42	42	10	-	8,343	8,821	9,313
TFV-48108-P	108	48	42	10	-	9,148	9,642	10,151
TFV-42114-P	114	42	42	10	-	9,024	9,527	10,046
TFV-48114-P	114	48	42	10	-	9,911	10,431	10,967
TFV-42120-P	120	42	42	10	-	9,267	9,770	10,289
TFV-48120-P	120	48	42	10	-	10,192	10,713	11,249
TFV-42132-P	132	42	42	10	-	10,158	10,682	11,221
TFV-48132-P	132	48	42	10	-	11,203	11,745	12,303
TFV-42144-P	144	42	42	12	-	11,090	11,635	12,197
TFV-48144-P	144	48	42	12	-	12,260	12,823	13,403



INSET LAMINATE TOP WITH HARDWOOD EDGE

OPTIONS	CODE	PRICE	NOTES
Power & Data Options			See pages 112-122
Polished Chrome Finish Options:			
Polished Chrome Open Frame Base	Add -PCOF-TWE	\$2,881	
Multi-Section Tops:			
102", 108", 114" and 120" one-piece tops split into two sections	Specify -2	\$843	Note: Power Matrix (center of table location only) cannot be specified when this option is selected

EDGE PROFILE



Two4Six Cutback Edge

GENERAL INFORMATION

- Seating capacity based on 27" per person
- Overall table height 42"
- Standard with quarter cut veneer
- One section of wire management channel provided per table
- Racetrack Bases have a removable access door

REQUIRED INFORMATION (ORDER CANNOT BE ENTERED WITHOUT THIS INFORMATION)

See appendix pages vi-viii for surface material options.

- Choose Laminate Finish
- Choose Wood Species & Finish for Hardwood Edge
- Choose Metal Finish
- Choose Solid Edge Band Finish or Coordinating Woodgrain Edge Band Finish, if -RCL Base specified



LAMINATE TOP WITH CUTBACK EDGE



RECTANGLE TOP

BASE KEY

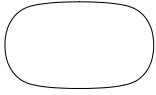
- OF Open Frame
- RCL Laminate Racetrack Base
- RCP Painted Racetrack Base
- RCV Veneer Racetrack Base

RECTANGLE TOP TABLES

MODEL #	LENGTH	WIDTH	HEIGHT	SEATING CAPACITY	-OF	-RCL	-RCP	-RCV
TFP-3060-PA	60	30	42	4	4,360	-	-	-
TFP-3660-PA	60	36	42	4	4,563	-	-	-
TFP-4260-PA	60	42	42	4	5,184	-	-	-
TFP-4860-PA	60	48	42	4	5,592	-	-	-
TFP-3066-PA	66	30	42	4	4,738	-	-	-
TFP-3666-PA	66	36	42	4	4,974	-	-	-
TFP-4266-PA	66	42	42	4	5,667	-	-	-
TFP-4866-PA	66	48	42	4	6,129	-	-	-
TFP-3072-PA	72	30	42	6	4,874	-	-	-
TFP-3672-PA	72	36	42	6	5,132	-	-	-
TFP-4272-PA	72	42	42	6	5,861	5,861	6,264	6,678
TFP-4872-PA	72	48	42	6	6,354	6,354	6,770	7,200
TFP-3078-PA	78	30	42	6	5,357	-	-	-
TFP-3678-PA	78	36	42	6	5,655	-	-	-
TFP-4278-PA	78	42	42	6	6,476	6,476	6,907	7,350
TFP-4878-PA	78	48	42	6	7,036	7,036	7,481	7,939
TFP-3084-PA	84	30	42	8	5,501	-	-	-
TFP-3684-PA	84	36	42	8	5,824	-	-	-
TFP-4284-PA	84	42	42	8	6,684	6,684	7,114	7,557
TFP-4884-PA	84	48	42	8	7,276	7,276	7,722	8,180
TFP-3090-PA	90	30	42	8	5,940	-	-	-
TFP-3690-PA	90	36	42	8	6,303	-	-	-
TFP-4290-PA	90	42	42	8	7,250	7,250	7,702	8,168
TFP-4890-PA	90	48	42	8	7,907	7,907	8,376	8,858
TFP-3096-PA	96	30	42	8	6,092	-	-	-
TFP-3696-PA	96	36	42	8	6,479	-	-	-
TFP-4296-PA	96	42	42	8	7,468	7,468	7,921	8,386
TFP-4896-PA	96	48	42	8	8,161	8,161	8,628	9,111
TFP-42102-PA	102	42	42	8	-	8,112	8,591	9,083
TFP-48102-PA	102	48	42	8	-	8,881	9,375	9,884
TFP-42108-PA	108	42	42	10	-	8,343	8,821	9,313
TFP-48108-PA	108	48	42	10	-	9,148	9,642	10,151
TFP-42114-PA	114	42	42	10	-	9,024	9,527	10,046
TFP-48114-PA	114	48	42	10	-	9,911	10,431	10,967
TFP-42120-PA	120	42	42	10	-	9,267	9,770	10,289
TFP-48120-PA	120	48	42	10	-	10,192	10,713	11,249
TFP-42132-PA	132	42	42	10	-	10,158	10,682	11,221
TFP-48132-PA	132	48	42	10	-	11,203	11,745	12,303
TFP-42144-PA	144	42	42	12	-	11,090	11,635	12,197
TFP-48144-PA	144	48	42	12	-	12,260	12,823	13,403



LAMINATE TOP WITH CUTBACK EDGE



SOFT RECTANGLE TOP

BASE KEY

- OF Open Frame
- RCL Laminate Racetrack Base
- RCP Painted Racetrack Base
- RCV Veneer Racetrack Base

SOFT RECTANGLE TOP TABLES

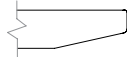
MODEL #	LENGTH	WIDTH	HEIGHT	SEATING CAPACITY	-OF	-RCL	-RCP	-RCV
TFV-3060-PA	60	30	42	4	4,360	-	-	-
TFV-3660-PA	60	36	42	4	4,563	-	-	-
TFV-4260-PA	60	42	42	4	5,184	-	-	-
TFV-4860-PA	60	48	42	4	5,592	-	-	-
TFV-3066-PA	66	30	42	4	4,738	-	-	-
TFV-3666-PA	66	36	42	4	4,974	-	-	-
TFV-4266-PA	66	42	42	4	5,667	-	-	-
TFV-4866-PA	66	48	42	4	6,129	-	-	-
TFV-3072-PA	72	30	42	6	4,874	-	-	-
TFV-3672-PA	72	36	42	6	5,132	-	-	-
TFV-4272-PA	72	42	42	6	5,861	5,861	6,264	6,678
TFV-4872-PA	72	48	42	6	6,354	6,354	6,770	7,200
TFV-3078-PA	78	30	42	6	5,357	-	-	-
TFV-3678-PA	78	36	42	6	5,655	-	-	-
TFV-4278-PA	78	42	42	6	6,476	6,476	6,907	7,350
TFV-4878-PA	78	48	42	6	7,036	7,036	7,481	7,939
TFV-3084-PA	84	30	42	8	5,501	-	-	-
TFV-3684-PA	84	36	42	8	5,824	-	-	-
TFV-4284-PA	84	42	42	8	6,684	6,684	7,114	7,557
TFV-4884-PA	84	48	42	8	7,276	7,276	7,722	8,180
TFV-3090-PA	90	30	42	8	5,940	-	-	-
TFV-3690-PA	90	36	42	8	6,303	-	-	-
TFV-4290-PA	90	42	42	8	7,250	7,250	7,702	8,168
TFV-4890-PA	90	48	42	8	7,907	7,907	8,376	8,858
TFV-3096-PA	96	30	42	8	6,092	-	-	-
TFV-3696-PA	96	36	42	8	6,479	-	-	-
TFV-4296-PA	96	42	42	8	7,468	7,468	7,921	8,386
TFV-4896-PA	96	48	42	8	8,161	8,161	8,628	9,111
TFV-42102-PA	102	42	42	8	-	8,112	8,591	9,083
TFV-48102-PA	102	48	42	8	-	8,881	9,375	9,884
TFV-42108-PA	108	42	42	10	-	8,343	8,821	9,313
TFV-48108-PA	108	48	42	10	-	9,148	9,642	10,151
TFV-42114-PA	114	42	42	10	-	9,024	9,527	10,046
TFV-48114-PA	114	48	42	10	-	9,911	10,431	10,967
TFV-42120-PA	120	42	42	10	-	9,267	9,770	10,289
TFV-48120-PA	120	48	42	10	-	10,192	10,713	11,249
TFV-42132-PA	132	42	42	10	-	10,158	10,682	11,221
TFV-48132-PA	132	48	42	10	-	11,203	11,745	12,303
TFV-42144-PA	144	42	42	12	-	11,090	11,635	12,197
TFV-48144-PA	144	48	42	12	-	12,260	12,823	13,403



LAMINATE TOP WITH CUTBACK EDGE

OPTIONS	CODE	PRICE	NOTES
Power & Data Options			See pages 112-122
Polished Chrome Finish Options:			
Polished Chrome Open Frame Base	Add -PCOF-TWE	\$2,881	
Multi-Section Tops:			
102", 108", 114" and 120" one-piece tops split into two sections	Specify -2	\$843	Note: Power Matrix (center of table location only) cannot be specified when this option is selected

EDGE PROFILE



Two4Six Cutback Edge

GENERAL INFORMATION

- Seating capacity based on 27" per person
- Overall table height 42"
- Standard with quarter cut veneer
- One section of wire management channel provided per table
- Racetrack Bases have a removable access door

REQUIRED INFORMATION (ORDER CANNOT BE ENTERED WITHOUT THIS INFORMATION)

See appendix pages vi-viii for surface material options.

- Choose Laminate Finish
- Choose Edge Band Finish
- Choose Metal Finish
- Choose Solid Edge Band Finish or Coordinating Woodgrain Edge Band Finish, if -RCL Base specified



LAMINATE TOP WITH SQUARE EDGE



RECTANGLE TOP

BASE KEY

OF Open Frame

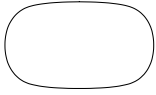
RCL Laminate Racetrack Base
 RCP Painted Racetrack Base
 RCV Veneer Racetrack Base

RECTANGLE TOP TABLES

MODEL #	LENGTH	WIDTH	HEIGHT	SEATING CAPACITY	-OF	-RCL	-RCP	-RCV
TFP-3060-PE	60	30	42	4	3,922	-	-	-
TFP-3660-PE	60	36	42	4	4,104	-	-	-
TFP-4260-PE	60	42	42	4	4,663	-	-	-
TFP-4860-PE	60	48	42	4	5,030	-	-	-
TFP-3066-PE	66	30	42	4	4,262	-	-	-
TFP-3666-PE	66	36	42	4	4,474	-	-	-
TFP-4266-PE	66	42	42	4	5,097	-	-	-
TFP-4866-PE	66	48	42	4	5,513	-	-	-
TFP-3072-PE	72	30	42	6	4,384	-	-	-
TFP-3672-PE	72	36	42	6	4,616	-	-	-
TFP-4272-PE	72	42	42	6	5,272	5,272	5,634	6,007
TFP-4872-PE	72	48	42	6	5,715	5,715	6,090	6,476
TFP-3078-PE	78	30	42	6	4,818	-	-	-
TFP-3678-PE	78	36	42	6	5,087	-	-	-
TFP-4278-PE	78	42	42	6	5,825	5,825	6,212	6,611
TFP-4878-PE	78	48	42	6	6,329	6,329	6,729	7,141
TFP-3084-PE	84	30	42	8	4,948	-	-	-
TFP-3684-PE	84	36	42	8	5,238	-	-	-
TFP-4284-PE	84	42	42	8	6,012	6,012	6,398	6,797
TFP-4884-PE	84	48	42	8	6,545	6,545	6,946	7,358
TFP-3090-PE	90	30	42	8	5,343	-	-	-
TFP-3690-PE	90	36	42	8	5,669	-	-	-
TFP-4290-PE	90	42	42	8	6,521	6,521	6,928	7,347
TFP-4890-PE	90	48	42	8	7,112	7,112	7,534	7,968
TFP-3096-PE	96	30	42	8	5,480	-	-	-
TFP-3696-PE	96	36	42	8	5,828	-	-	-
TFP-4296-PE	96	42	42	8	6,717	6,717	7,124	7,543
TFP-4896-PE	96	48	42	8	7,340	7,340	7,761	8,195
TFP-42102-PE	102	42	42	8	-	7,297	7,727	8,170
TFP-48102-PE	102	48	42	8	-	7,988	8,432	8,891
TFP-42108-PE	108	42	42	10	-	7,504	7,934	8,377
TFP-48108-PE	108	48	42	10	-	8,228	8,673	9,130
TFP-42114-PE	114	42	42	10	-	8,117	8,569	9,036
TFP-48114-PE	114	48	42	10	-	8,914	9,383	9,865
TFP-42120-PE	120	42	42	10	-	8,336	8,788	9,254
TFP-48120-PE	120	48	42	10	-	9,168	9,636	10,118
TFP-42132-PE	132	42	42	10	-	9,137	9,608	10,093
TFP-48132-PE	132	48	42	10	-	10,076	10,564	11,067
TFP-42144-PE	144	42	42	12	-	9,975	10,466	10,971
TFP-48144-PE	144	48	42	12	-	11,028	11,534	12,056



LAMINATE TOP WITH SQUARE EDGE



SOFT RECTANGLE TOP

BASE KEY

OF Open Frame

RCL Laminate Racetrack Base
 RCP Painted Racetrack Base
 RCV Veneer Racetrack Base

SOFT RECTANGLE TOP TABLES

MODEL #	LENGTH	WIDTH	HEIGHT	SEATING CAPACITY	-OF	-RCL	-RCP	-RCV
TFV-3060-PE	60	30	42	4	3,922	-	-	-
TFV-3660-PE	60	36	42	4	4,104	-	-	-
TFV-4260-PE	60	42	42	4	4,663	-	-	-
TFV-4860-PE	60	48	42	4	5,030	-	-	-
TFV-3066-PE	66	30	42	4	4,262	-	-	-
TFV-3666-PE	66	36	42	4	4,474	-	-	-
TFV-4266-PE	66	42	42	4	5,097	-	-	-
TFV-4866-PE	66	48	42	4	5,513	-	-	-
TFV-3072-PE	72	30	42	6	4,384	-	-	-
TFV-3672-PE	72	36	42	6	4,616	-	-	-
TFV-4272-PE	72	42	42	6	5,272	5,272	5,634	6,007
TFV-4872-PE	72	48	42	6	5,715	5,715	6,090	6,476
TFV-3078-PE	78	30	42	6	4,818	-	-	-
TFV-3678-PE	78	36	42	6	5,087	-	-	-
TFV-4278-PE	78	42	42	6	5,825	5,825	6,212	6,611
TFV-4878-PE	78	48	42	6	6,329	6,329	6,729	7,141
TFV-3084-PE	84	30	42	8	4,948	-	-	-
TFV-3684-PE	84	36	42	8	5,238	-	-	-
TFV-4284-PE	84	42	42	8	6,012	6,012	6,398	6,797
TFV-4884-PE	84	48	42	8	6,545	6,545	6,946	7,358
TFV-3090-PE	90	30	42	8	5,343	-	-	-
TFV-3690-PE	90	36	42	8	5,669	-	-	-
TFV-4290-PE	90	42	42	8	6,521	6,521	6,928	7,347
TFV-4890-PE	90	48	42	8	7,112	7,112	7,534	7,968
TFV-3096-PE	96	30	42	8	5,480	-	-	-
TFV-3696-PE	96	36	42	8	5,828	-	-	-
TFV-4296-PE	96	42	42	8	6,717	6,717	7,124	7,543
TFV-4896-PE	96	48	42	8	7,340	7,340	7,761	8,195
TFV-42102-PE	102	42	42	8	-	7,297	7,727	8,170
TFV-48102-PE	102	48	42	8	-	7,988	8,432	8,891
TFV-42108-PE	108	42	42	10	-	7,504	7,934	8,377
TFV-48108-PE	108	48	42	10	-	8,228	8,673	9,130
TFV-42114-PE	114	42	42	10	-	8,117	8,569	9,036
TFV-48114-PE	114	48	42	10	-	8,914	9,383	9,865
TFV-42120-PE	120	42	42	10	-	8,336	8,788	9,254
TFV-48120-PE	120	48	42	10	-	9,168	9,636	10,118
TFV-42132-PE	132	42	42	10	-	9,137	9,608	10,093
TFV-48132-PE	132	48	42	10	-	10,076	10,564	11,067
TFV-42144-PE	144	42	42	12	-	9,975	10,466	10,971
TFV-48144-PE	144	48	42	12	-	11,028	11,534	12,056



LAMINATE TOP WITH SQUARE EDGE

OPTIONS	CODE	PRICE	NOTES
Power & Data Options			See pages 112-122
Polished Chrome Finish Options:			
Polished Chrome Open Frame Base	Add -PCOF-TWE	\$2,881	
Multi-Section Tops:			
102", 108", 114" and 120" one-piece tops split into two sections	Specify -2	\$843	Note: Power Matrix (center of table location only) cannot be specified when this option is selected

EDGE PROFILE



Two4Six Square Edge

GENERAL INFORMATION

- Seating capacity based on 27" per person
- Overall table height 42"
- Standard with quarter cut veneer
- One section of wire management channel provided per table
- Racetrack Bases have a removable access door

REQUIRED INFORMATION (ORDER CANNOT BE ENTERED WITHOUT THIS INFORMATION)

See appendix pages vi-viii for surface material options.

- Choose Laminate Finish
- Choose Solid Edge Band Finish or Coordinating Woodgrain Edge Band Finish
- Choose Metal Finish



GLASS TOP



RECTANGLE TOP

BASE KEY

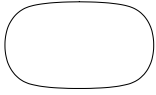
- OF Open Frame
- RCL Laminate Racetrack Base
- RCP Painted Racetrack Base
- RCV Veneer Racetrack Base

RECTANGLE TOP TABLES

MODEL #	LENGTH	WIDTH	HEIGHT	SEATING CAPACITY	-OF	-RCL	-RCP	-RCV
TFP-3060-G	60	30	42	4	7,197	-	-	-
TFP-3660-G	60	36	42	4	7,532	-	-	-
TFP-4260-G	60	42	42	4	8,557	-	-	-
TFP-4860-G	60	48	42	4	9,231	-	-	-
TFP-3066-G	66	30	42	4	7,821	-	-	-
TFP-3666-G	66	36	42	4	8,211	-	-	-
TFP-4266-G	66	42	42	4	9,354	-	-	-
TFP-4866-G	66	48	42	4	10,117	-	-	-
TFP-3072-G	72	30	42	6	8,045	-	-	-
TFP-3672-G	72	36	42	6	8,471	-	-	-
TFP-4272-G	72	42	42	6	9,676	9,676	10,340	11,023
TFP-4872-G	72	48	42	6	10,488	10,488	11,176	11,885
TFP-3078-G	78	30	42	6	8,843	-	-	-
TFP-3678-G	78	36	42	6	9,336	-	-	-
TFP-4278-G	78	42	42	6	10,690	10,690	11,401	12,133
TFP-4878-G	78	48	42	6	11,615	11,615	12,349	13,106
TFP-3084-G	84	30	42	8	9,081	-	-	-
TFP-3684-G	84	36	42	8	9,613	-	-	-
TFP-4284-G	84	42	42	8	11,033	11,033	11,743	12,474
TFP-4884-G	84	48	42	8	12,011	12,011	12,747	13,504
TFP-3090-G	90	30	42	8	9,805	-	-	-
TFP-3690-G	90	36	42	8	10,404	-	-	-
TFP-4290-G	90	42	42	8	11,967	11,967	12,714	13,484
TFP-4890-G	90	48	42	8	13,053	13,053	13,827	14,622
TFP-3096-G	96	30	42	8	10,056	-	-	-
TFP-3696-G	96	36	42	8	10,696	-	-	-
TFP-4296-G	96	42	42	8	12,328	12,328	13,075	13,844
TFP-4896-G	96	48	42	8	13,471	13,471	14,243	15,040
TFP-42102-G	102	42	42	8	-	13,392	14,181	14,994
TFP-48102-G	102	48	42	8	-	14,660	15,476	16,317
TFP-42108-G	108	42	42	10	-	13,772	14,562	15,374
TFP-48108-G	108	48	42	10	-	15,101	15,917	16,756
TFP-42114-G	114	42	42	10	-	14,897	15,727	16,583
TFP-48114-G	114	48	42	10	-	16,360	17,220	18,104
TFP-42120-G	120	42	42	10	-	15,298	16,128	16,984
TFP-48120-G	120	48	42	10	-	16,825	17,685	18,569
TFP-42132-G	132	42	42	10	-	16,769	17,633	18,524
TFP-48132-G	132	48	42	10	-	18,493	19,388	20,310
TFP-42144-G	144	42	42	12	-	18,307	19,207	20,134
TFP-48144-G	144	48	42	12	-	20,238	21,168	22,126



GLASS TOP



SOFT RECTANGLE TOP

BASE KEY

OF Open Frame

RCL Laminate Racetrack Base
RCP Painted Racetrack Base
RCV Veneer Racetrack Base

SOFT RECTANGLE TOP TABLES

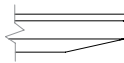
MODEL #	LENGTH	WIDTH	HEIGHT	SEATING CAPACITY	-OF	-RCL	-RCP	-RCV
TFV-3060-G	60	30	42	4	7,197	-	-	-
TFV-3660-G	60	36	42	4	7,532	-	-	-
TFV-4260-G	60	42	42	4	8,557	-	-	-
TFV-4860-G	60	48	42	4	9,231	-	-	-
TFV-3066-G	66	30	42	4	7,821	-	-	-
TFV-3666-G	66	36	42	4	8,211	-	-	-
TFV-4266-G	66	42	42	4	9,354	-	-	-
TFV-4866-G	66	48	42	4	10,117	-	-	-
TFV-3072-G	72	30	42	6	8,045	-	-	-
TFV-3672-G	72	36	42	6	8,471	-	-	-
TFV-4272-G	72	42	42	6	9,676	9,676	10,340	11,023
TFV-4872-G	72	48	42	6	10,488	10,488	11,176	11,885
TFV-3078-G	78	30	42	6	8,843	-	-	-
TFV-3678-G	78	36	42	6	9,336	-	-	-
TFV-4278-G	78	42	42	6	10,690	10,690	11,401	12,133
TFV-4878-G	78	48	42	6	11,615	11,615	12,349	13,106
TFV-3084-G	84	30	42	8	9,081	-	-	-
TFV-3684-G	84	36	42	8	9,613	-	-	-
TFV-4284-G	84	42	42	8	11,033	11,033	11,743	12,474
TFV-4884-G	84	48	42	8	12,011	12,011	12,747	13,504
TFV-3090-G	90	30	42	8	9,805	-	-	-
TFV-3690-G	90	36	42	8	10,404	-	-	-
TFV-4290-G	90	42	42	8	11,967	11,967	12,714	13,484
TFV-4890-G	90	48	42	8	13,053	13,053	13,827	14,622
TFV-3096-G	96	30	42	8	10,056	-	-	-
TFV-3696-G	96	36	42	8	10,696	-	-	-
TFV-4296-G	96	42	42	8	12,328	12,328	13,075	13,844
TFV-4896-G	96	48	42	8	13,471	13,471	14,243	15,040
TFV-42102-G	102	42	42	8	-	13,392	14,181	14,994
TFV-48102-G	102	48	42	8	-	14,660	15,476	16,317
TFV-42108-G	108	42	42	10	-	13,772	14,562	15,374
TFV-48108-G	108	48	42	10	-	15,101	15,917	16,756
TFV-42114-G	114	42	42	10	-	14,897	15,727	16,583
TFV-48114-G	114	48	42	10	-	16,360	17,220	18,104
TFV-42120-G	120	42	42	10	-	15,298	16,128	16,984
TFV-48120-G	120	48	42	10	-	16,825	17,685	18,569
TFV-42132-G	132	42	42	10	-	16,769	17,633	18,524
TFV-48132-G	132	48	42	10	-	18,493	19,388	20,310
TFV-42144-G	144	42	42	12	-	18,307	19,207	20,134
TFV-48144-G	144	48	42	12	-	20,238	21,168	22,126



GLASS TOP

OPTIONS	CODE	PRICE	NOTES
Power & Data Options			See pages 112-122
Polished Chrome Finish Options:			
Polished Chrome Open Frame Base	Add -PCOF-TWE	\$2,881	
Satin Glass Options:			
Satin Glass	Add -TFSG	\$691	
Multi-Section Tops:			
102", 108", 114" and 120" one-piece tops split into two sections	Specify -2	\$843	Note: Power Matrix (center of table location only) cannot be specified when this option is selected

EDGE PROFILE



Two4Six Glass Edge

GENERAL INFORMATION

- Tops are 1-1/8"-thick with 3/16"-thick hardwood edge band
- Seating capacity based on 27" per person
- Overall table height 42"
- Standard with quarter cut veneer
- One section of wire management channel provided per table
- Racetrack Bases have a removable access door

REQUIRED INFORMATION (ORDER CANNOT BE ENTERED WITHOUT THIS INFORMATION)

See appendix pages vi-viii for surface material options.

- Choose Glass Finish
- Choose Metal Finish
- Choose Solid Edge Band Finish or Coordinating Woodgrain Edge Band Finish, if -RCL Base specified
- Choose Sub-Top Finish: Paint Finish or Wood Species & Finish



SOLID SURFACE TOP



RECTANGLE TOP

BASE KEY

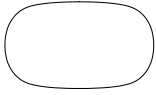
- OF Open Frame
- RCL Laminate Racetrack Base
- RCP Painted Racetrack Base
- RCV Veneer Racetrack Base

RECTANGLE TOP TABLES

MODEL #	LENGTH	WIDTH	HEIGHT	SEATING CAPACITY	-OF	-RCL	-RCP	-RCV
TFP-3060-SS	60	30	42	4	7,520	-	-	-
TFP-3660-SS	60	36	42	4	7,870	-	-	-
TFP-4260-SS	60	42	42	4	8,941	-	-	-
TFP-4860-SS	60	48	42	4	9,645	-	-	-
TFP-3066-SS	66	30	42	4	8,172	-	-	-
TFP-3666-SS	66	36	42	4	8,579	-	-	-
TFP-4266-SS	66	42	42	4	9,774	-	-	-
TFP-4866-SS	66	48	42	4	10,571	-	-	-
TFP-3072-SS	72	30	42	6	8,406	-	-	-
TFP-3672-SS	72	36	42	6	8,851	-	-	-
TFP-4272-SS	72	42	42	6	10,110	10,110	10,804	11,518
TFP-4872-SS	72	48	42	6	10,959	10,959	11,678	12,418
TFP-3078-SS	78	30	42	6	9,239	-	-	-
TFP-3678-SS	78	36	42	6	9,754	-	-	-
TFP-4278-SS	78	42	42	6	11,169	11,169	11,913	12,677
TFP-4878-SS	78	48	42	6	12,136	12,136	12,904	13,694
TFP-3084-SS	84	30	42	8	9,489	-	-	-
TFP-3684-SS	84	36	42	8	10,045	-	-	-
TFP-4284-SS	84	42	42	8	11,528	11,528	12,270	13,034
TFP-4884-SS	84	48	42	8	12,550	12,550	13,319	14,110
TFP-3090-SS	90	30	42	8	10,245	-	-	-
TFP-3690-SS	90	36	42	8	10,871	-	-	-
TFP-4290-SS	90	42	42	8	12,504	12,504	13,285	14,089
TFP-4890-SS	90	48	42	8	13,639	13,639	14,447	15,278
TFP-3096-SS	96	30	42	8	10,507	-	-	-
TFP-3696-SS	96	36	42	8	11,176	-	-	-
TFP-4296-SS	96	42	42	8	12,881	12,881	13,662	14,465
TFP-4896-SS	96	48	42	8	14,076	14,076	14,882	15,715
TFP-42102-SS	102	42	42	8	-	13,992	14,817	15,666
TFP-48102-SS	102	48	42	8	-	15,318	16,170	17,049
TFP-42108-SS	108	42	42	10	-	14,390	15,215	16,064
TFP-48108-SS	108	48	42	10	-	15,779	16,631	17,508
TFP-42114-SS	114	42	42	10	-	15,565	16,433	17,327
TFP-48114-SS	114	48	42	10	-	17,094	17,992	18,917
TFP-42120-SS	120	42	42	10	-	15,984	16,851	17,746
TFP-48120-SS	120	48	42	10	-	17,580	18,478	19,402
TFP-42132-SS	132	42	42	10	-	17,521	18,424	19,355
TFP-48132-SS	132	48	42	10	-	19,323	20,258	21,221
TFP-42144-SS	144	42	42	12	-	19,129	20,069	21,037
TFP-48144-SS	144	48	42	12	-	21,146	22,118	23,119



SOLID SURFACE TOP



SOFT RECTANGLE TOP

BASE KEY

- OF Open Frame
- RCL Laminate Racetrack Base
- RCP Painted Racetrack Base
- RCV Veneer Racetrack Base

SOFT RECTANGLE TOP TABLES

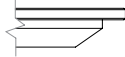
MODEL #	LENGTH	WIDTH	HEIGHT	SEATING CAPACITY	-OF	-RCL	-RCP	-RCV
TFV-3060-SS	60	30	42	4	7,520	-	-	-
TFV-3660-SS	60	36	42	4	7,870	-	-	-
TFV-4260-SS	60	42	42	4	8,941	-	-	-
TFV-4860-SS	60	48	42	4	9,645	-	-	-
TFV-3066-SS	66	30	42	4	8,172	-	-	-
TFV-3666-SS	66	36	42	4	8,579	-	-	-
TFV-4266-SS	66	42	42	4	9,774	-	-	-
TFV-4866-SS	66	48	42	4	10,571	-	-	-
TFV-3072-SS	72	30	42	6	8,406	-	-	-
TFV-3672-SS	72	36	42	6	8,851	-	-	-
TFV-4272-SS	72	42	42	6	10,110	10,110	10,804	11,518
TFV-4872-SS	72	48	42	6	10,959	10,959	11,678	12,418
TFV-3078-SS	78	30	42	6	9,239	-	-	-
TFV-3678-SS	78	36	42	6	9,754	-	-	-
TFV-4278-SS	78	42	42	6	11,169	11,169	11,913	12,677
TFV-4878-SS	78	48	42	6	12,136	12,136	12,904	13,694
TFV-3084-SS	84	30	42	8	9,489	-	-	-
TFV-3684-SS	84	36	42	8	10,045	-	-	-
TFV-4284-SS	84	42	42	8	11,528	11,528	12,270	13,034
TFV-4884-SS	84	48	42	8	12,550	12,550	13,319	14,110
TFV-3090-SS	90	30	42	8	10,245	-	-	-
TFV-3690-SS	90	36	42	8	10,871	-	-	-
TFV-4290-SS	90	42	42	8	12,504	12,504	13,285	14,089
TFV-4890-SS	90	48	42	8	13,639	13,639	14,447	15,278
TFV-3096-SS	96	30	42	8	10,507	-	-	-
TFV-3696-SS	96	36	42	8	11,176	-	-	-
TFV-4296-SS	96	42	42	8	12,881	12,881	13,662	14,465
TFV-4896-SS	96	48	42	8	14,076	14,076	14,882	15,715
TFV-42102-SS	102	42	42	8	-	13,992	14,817	15,666
TFV-48102-SS	102	48	42	8	-	15,318	16,170	17,049
TFV-42108-SS	108	42	42	10	-	14,390	15,215	16,064
TFV-48108-SS	108	48	42	10	-	15,779	16,631	17,508
TFV-42114-SS	114	42	42	10	-	15,565	16,433	17,327
TFV-48114-SS	114	48	42	10	-	17,094	17,992	18,917
TFV-42120-SS	120	42	42	10	-	15,984	16,851	17,746
TFV-48120-SS	120	48	42	10	-	17,580	18,478	19,402
TFV-42132-SS	132	42	42	10	-	17,521	18,424	19,355
TFV-48132-SS	132	48	42	10	-	19,323	20,258	21,221
TFV-42144-SS	144	42	42	12	-	19,129	20,069	21,037
TFV-48144-SS	144	48	42	12	-	21,146	22,118	23,119



SOLID SURFACE TOP

OPTIONS	CODE	PRICE	NOTES
Power & Data Options			See pages 112-122
Polished Chrome Finish Options:			
Polished Chrome Open Frame Base	Add -PCOF-TWE	\$2,881	
Multi-Section Tops:			
102", 108", 114" and 120" one-piece tops split into two sections	Specify -2	\$843	Note: Power Matrix (center of table location only) cannot be specified when this option is selected

EDGE PROFILE



Two4Six Solid Surface Edge

GENERAL INFORMATION

- Seating capacity based on 27" per person
- Overall table height 42"
- Standard with quarter cut veneer
- One section of wire management channel provided per table
- Racetrack Bases have a removable access door

REQUIRED INFORMATION (ORDER CANNOT BE ENTERED WITHOUT THIS INFORMATION)

See appendix pages vi-viii for surface material options.

- Choose Solid Surface Finish
- Choose Metal Finish
- Choose Solid Edge Band Finish or Coordinating Woodgrain Edge Band Finish, if -RCL Base specified

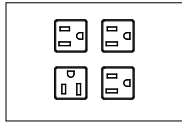


POWER AND DATA OPTIONS

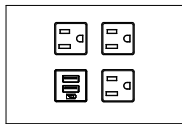
POWER MATRIX SMALL	MODEL #	DESCRIPTION	W x D	SIMPLEX OUTLETS	BLANK	DATA*	PRICE
	PM-SM-G	Small - Glass Door	6 x 5.375	2	2	1	1,635
	PM-SM-M	Small - Metal Door	6 x 5.375	2	2	1	1,635
	PM-SM-W	Small - Wood Door	6 x 5.375	2	2	1	2,062

*Each data faceplate includes two RJ-45 (Data) connectors

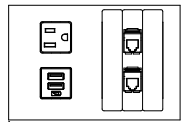
OPTIONS	CODE	PRICE	NOTES
4 Simplex Receptacles	Add -FOUR	No Charge	Replace Modular AV Inserts/Plates with 2 simplex receptacles
3 Simplex Receptacles/Charging USB-A+C	Add -THREE-C	No Charge	Replace Modular AV Inserts/Plates with 1 simplex receptacle and 1 charging USB-A+C
USB-A+C Charging	Add -USB-C	\$128 per unit	USB-A+C charger, replaces one of the simplex outlets
Polished Chrome Door	Add -PD	\$245 per unit	Only available with metal door option
Polished Chrome Bezel	Add -PB	\$349 per unit	Only available on glass, stone/quartz and laminate top tables
Field-Wired	Add -FW	Deduct \$48 per unit	May be required in New York City, Chicago and San Francisco. Check with an electrician for local codes and requirements.
Single Infeed Option Available	See page 115		



-FOUR



-THREE-C



-USB-C

GENERAL INFORMATION

- Wood species and finish will default to the same as the table top if wood door version is specified
- Glass & wood doors are 1/4"-thick, metal doors are 1/8"-thick
- Glass door is back-painted low-iron glass
- Interior body is clear anodized aluminum
- Each unit includes a 15 amp, 12' power infeed (plug in only)
- If Field-Wired option is specified, each unit includes a 6' flexible metal conduit and requires a hardwire connection
- Standard configuration: Two simplex receptacles, two RJ-45 data connectors and two single blank faceplates
- When specified on tables with laminate, glass or stone/quartz tops, each Power Matrix unit will include a metal bezel and is limited to the glass and metal door options. (-B) will be added to the model number for the bezel.
- Not available on Standing Height Media Tables
- Additional data/AV faceplate options are on pages 115

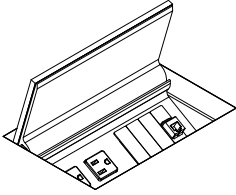
REQUIRED INFORMATION: (ORDER CANNOT BE ENTERED WITHOUT THIS INFORMATION)

See appendix pages vi-viii for surface material options.

- Choose location code & quantity from the chart on page 115
- Choose Glass Door Finish, if glass door version is specified
- Choose Metal Finish, if metal door version is specified or for the bezel finish on laminate, glass and stone/quartz tables



POWER AND DATA OPTIONS

POWER MATRIX MEDIUM	MODEL #	DESCRIPTION	W x D	SIMPLEX OUTLETS	BLANK	DATA*	PRICE
	PM-MD-G	Medium - Glass Door	6 x 8.25	4	3	1	2,576
	PM-MD-M	Medium - Metal Door	6 x 8.25	4	3	1	2,576
	PM-MD-W	Medium - Wood Door	6 x 8.25	4	3	1	3,006

*Each data faceplate includes two RJ-45 (Data) connectors

OPTIONS	CODE	PRICE	NOTES
USB-A+C Charging	Add -USB-C	\$128 per unit	USB-A+C charger, replaces one of the simplex outlets
Polished Chrome Door	Add -PD	\$330 per unit	Only available with metal door option
Polished Chrome Bezel	Add -PB	\$390 per unit	Only available on glass, stone/quartz and laminate top tables
Field-Wired	Add -FW	Deduct \$48 per unit	May be required in New York City, Chicago and San Francisco. Check with an electrician for local codes and requirements.
Single Infeed Option Available	See page 115		

GENERAL INFORMATION

- Wood species and finish will default to the same as the table top if wood door version is specified
- Glass & wood doors are 1/4"-thick, metal doors are 1/8"-thick
- Glass door is back-painted low-iron glass
- Interior body is clear anodized aluminum
- Each unit includes a 15 amp, 12' power infeed (plug in only)
- If Field-Wired option is specified, each unit includes a 6' flexible metal conduit and requires a hardwire connection
- Standard configuration: Two simplex receptacles, two RJ-45 data connectors and two single blank faceplates
- When specified on tables with laminate, glass or stone/quartz tops, each Power Matrix unit will include a metal bezel and is limited to the glass and metal door options. (-B) will be added to the model number for the bezel.
- Not available on Standing Height Media Tables
- Additional data/AV faceplate options are on pages 115

REQUIRED INFORMATION: (ORDER CANNOT BE ENTERED WITHOUT THIS INFORMATION)

See appendix pages vi-viii for surface material options.

- Choose location code & quantity from the chart on page 115
- Choose Glass Door Finish, if glass door version is specified
- Choose Metal Finish, if metal door version is specified or for the bezel finish on laminate, glass and stone/quartz tables



POWER AND DATA OPTIONS

LOCATION CODES	POWER MATRIX SMALL	POWER MATRIX MEDIUM	LOCATION	QUANTITY OF UNITS TO ORDER
PS-1	PM-1		One at center	1
PS-1W	PM-1W		One at wall end (Media Table only)	1
PS-2*	PM-2*		One at each end	2
PS-3*	PM-3*		One at center and one at each end	3
PS-4*	PM-4*		Four equally spaced	4

*Not offered on Media Tables or Standing Height Tables

DOOR MATERIAL AND LOCATION AVAILABILITY BY TABLE SIZE

W = Wood Door G = Glass Door M = Metal Door

Length	Top Sections	Power Matrix Small					Power Matrix Medium				
		PS-1	PS-1W [†]	PS-2*	PS-3*	PS-4*	PM-1	PM-1W [†]	PM-2*	PM-3*	PM-4*
48	1	W/G/M	-	-	-	-	-	-	-	-	-
54	1	W/G/M	-	-	-	-	-	-	-	-	-
60	1	W/G/M	W/G/M	-	-	-	-	W/G/M	-	-	-
66	1	W/G/M	W/G/M	-	-	-	W/G/M	W/G/M	-	-	-
72	1	W/G/M	W/G/M	-	-	-	W/G/M	W/G/M	-	-	-
84	1	W/G/M	W/G/M	-	-	-	W/G/M	W/G/M	-	-	-
90	1	W/G/M	W/G/M	-	-	-	W/G/M	W/G/M	-	-	-
96	1	W/G/M	W/G/M	-	-	-	W/G/M	W/G/M	-	-	-
102	1	W/G/M	-	W/G/M	W/G/M	-	W/G/M	-	W/G/M	W/G/M	-
102	2	-	-	W/G/M	-	-	-	-	W/G/M	-	-
108	1	W/G/M	-	W/G/M	W/G/M	-	W/G/M	-	W/G/M	W/G/M	-
108	2	-	-	W/G/M	-	-	-	-	W/G/M	-	-
114	1	W/G/M	-	W/G/M	W/G/M	-	W/G/M	-	W/G/M	W/G/M	-
114	2	-	-	W/G/M	-	-	-	-	W/G/M	-	-
120	1	W/G/M	-	W/G/M	W/G/M	-	W/G/M	-	W/G/M	W/G/M	-
120	2	-	-	W/G/M	-	-	-	-	W/G/M	-	-
132	2	-	-	W/G/M	-	W/G/M	-	-	W/G/M	-	W/G/M
144	2	-	-	W/G/M	-	W/G/M	-	-	W/G/M	-	W/G/M
156	2	-	-	W/G/M	-	W/G/M	-	-	W/G/M	-	W/G/M
168	2	-	-	W/G/M	-	W/G/M	-	-	W/G/M	-	W/G/M
180	2	-	-	W/G/M	-	W/G/M	-	-	W/G/M	-	W/G/M
192	2	-	-	W/G/M	-	W/G/M	-	-	W/G/M	-	W/G/M
192	4	-	-	W/G/M	-	W/G/M	-	-	W/G/M	-	W/G/M
204	2	-	-	W/G/M	-	W/G/M	-	-	W/G/M	-	W/G/M
204	4	-	-	W/G/M	-	W/G/M	-	-	W/G/M	-	W/G/M
216	2	-	-	W/G/M	-	W/G/M	-	-	W/G/M	-	W/G/M
216	4	-	-	W/G/M	-	W/G/M	-	-	W/G/M	-	W/G/M
228	2	-	-	W/G/M	-	W/G/M	-	-	W/G/M	-	W/G/M
228	4	-	-	W/G/M	-	W/G/M	-	-	W/G/M	-	W/G/M
240	2	-	-	W/G/M	-	W/G/M	-	-	W/G/M	-	W/G/M
240	4	-	-	W/G/M	-	W/G/M	-	-	W/G/M	-	W/G/M

[†]Available on Media Tables only

*Not offered on Media Tables or Standing Height Tables




POWER AND DATA OPTIONS

SINGLE INFEED OPTION	MODEL #	DESCRIPTION	PRICE
	SI-H	Single In-Feed Option, Hard-wired	608
	SI-C	Single In-Feed Option, Corded (Plug-in)	734

GENERAL INFORMATION

- Tables 72" - 120" in length include 2 duplex receptacles with the modular power system
- Tables 132" - 240" in length include 3 duplex receptacles with the modular power system
- Hardwired and Corded Single In-Feed options are 7' long
- Single In-Feed option cannot be specified in conjunction with the Field-Wired (-FW) option
- Corded Single In-Feed option will require a 20-amp power outlet in the floor monument and reduces the modular electrical system in the table to a single circuit

RETRACTORS	MODEL #	DESCRIPTION	PRICE
 CR-HDMI	CR-CAT6	CAT6 Retractor	996
	CR-HDMI	HDMI Retractor	996
	CR-DISPLAY	Display Port Retractor	996
	CR-USB	Data USB Retractor	996

GENERAL INFORMATION

- Mounting bracket and attaching hardware included with each retractor
- Can only be used with Power Matrix Small or Medium units
- Not available on square, round or soft square tables
- One Cable Pass Through Set (one top, one bottom) Modular AV Insert/Plate included. Double style Modular AV Inserts/Plates.
- See page 15 for availability by table size

DATA FACEPLATES	MODEL #	DESCRIPTION	STYLE	W x H	PRICE
	FLDF-1	Blank faceplate, single height	Single	3-1/2 x 5/8	81
	FLDF-2	One VGA 15-pin HD Female to Female Gender Changer, one 3.5mm Stereo Mini Jack to Solder Tabs	Single	3-1/2 x 5/8	284
	FLDF-3	One VGA 15-pin HD Female to Female Gender Changer	Single	3-1/2 x 5/8	223
	FLDF-4	One RJ-11 Female to Punch Down - Phone	Single	3-1/2 x 5/8	223
	FLDF-5	One RJ-45 Female to Female Barrel - Data	Single	3-1/2 x 5/8	182
	FLDF-6	Two RJ-45 Female to Female Barrels, single height	Single	3-1/2 x 5/8	244
	FLDF-7	Two RJ-45 Female to Punch Down for CAT 6 - AMP	Single	3-1/2 x 5/8	345
	FLDF-8	Two RJ-45 Female to Punch Down for CAT 6 - Leviton	Single	3-1/2 x 5/8	345
	FLDF-10	Two RJ-45 Female to Punch Down for CAT 6 - Panduit	Single	3-1/2 x 5/8	345
	FLDF-11	Two USB A Female to Two USB A Female on 10" Pigtailes	Single	3-1/2 x 5/8	386
	FLDF-12	Blank faceplate, double height	Double	3-1/2 x 1-3/8	101
	FLDF-13	Two RJ-45 Female to Female Barrels, double height	Double	3-1/2 x 1-3/8	244
	FLDF-14	Cable Pass-Through Set - one top, one bottom	Double	3-1/2 x 1-3/8	426
	FLDF-15	One HDMI Female to Female Barrel	Single	3-1/2 x 5/8	284

GENERAL INFORMATION

- Each TW-RAIL-DATA unit holds two single space faceplates
- Faceplates are black



POWER AND DATA OPTIONS

FOUR PORT POWER CAP	MODEL #	SHAPE	DESCRIPTION	L x W	SIMPLEX OUTLETS	DUAL USB-A+C	DATA	ONE AT CENTER OR END	ONE AT EACH END	EQUALLY SPACED STARTING AT 96"	EQUALLY SPACED STARTING AT 132"
								-1	-2	-3	-4
<p>CAP-SUUS</p>	CAP-SUUS-B-C	Racetrack	Black Simplex	9 x 2	2	2	-	1,710	3,420	5,130	6,840
	CAP-SUUS-W-C	Racetrack	White Simplex	9 x 2	2	2	-	1,710	3,420	5,130	6,840
<p>CAP-SUAA</p>	CAP-SUAA-B-C	Racetrack	Black Simplex / Modular AV Insert/Plate	9 x 2	1	1	2	1,419	2,838	4,257	5,676
	CAP-SUAA-W-C	Racetrack	White Simplex / Modular AV Insert/Plate	9 x 2	1	1	2	1,419	2,838	4,257	5,676
<p>CAP-SSAA</p>	CAP-SSAA-B	Racetrack	Black Simplex / Modular AV Insert/Plate	9 x 2	2	-	2	1,245	2,490	3,735	4,980
	CAP-SSAA-W	Racetrack	White Simplex / Modular AV Insert/Plate	9 x 2	2	-	2	1,245	2,490	3,735	4,980

OPTIONS	CODE	PRICE	NOTES
Polished Chrome Plate	Add -PCP	\$78 per unit	
Field-Wired	Add -FW	Add \$107 per unit	May be required in New York City, Chicago and San Francisco. Check with an electrician for local codes and requirements.

GENERAL INFORMATION

- Data includes two single space Modular AV Inserts/Plates
- Reference location chart

REQUIRED INFORMATION: (ORDER CANNOT BE ENTERED WITHOUT THIS INFORMATION)

- See appendix pages vi-viii for surface material options.
- Choose Metal Finish (unless Polished Chrome has been specified)

TWO PORT POWER CAP	MODEL #	SHAPE	DESCRIPTION	L x W	SIMPLEX OUTLETS	DUAL USB-A+C	DATA	ONE AT CENTER OR END	ONE AT EACH END	EQUALLY SPACED STARTING AT 96"	EQUALLY SPACED STARTING AT 132"
								-1	-2	-3	-4
<p>CAP-SU</p>	CAP-SU-B-C	Racetrack	Black Simplex	5.5 x 2	1	1	-	1,249	2,498	3,747	4,996
	CAP-SU-W-C	Racetrack	White Simplex	5.5 x 2	1	1	-	1,249	2,498	3,747	4,996
<p>CAP-SS</p>	CAP-SS-B	Racetrack	Black Simplex	5.5 x 2	2	-	-	1,072	2,144	3,216	4,288
	CAP-SS-W	Racetrack	White Simplex	5.5 x 2	2	-	-	1,072	2,144	3,216	4,288

OPTIONS	CODE	PRICE	NOTES
Polished Chrome Plate	Add -PCP	\$78 per unit	
Field-Wired	Add -FW	Add \$107 per unit	May be required in New York City, Chicago and San Francisco. Check with an electrician for local codes and requirements.

GENERAL INFORMATION


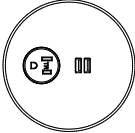
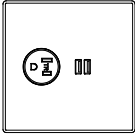
- Reference location chart

REQUIRED INFORMATION: (ORDER CANNOT BE ENTERED WITHOUT THIS INFORMATION)

- See appendix pages vi-viii for surface material options.
- Choose Metal Finish (unless Polished Chrome has been specified)



POWER AND DATA OPTIONS

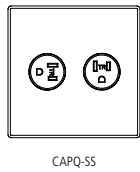
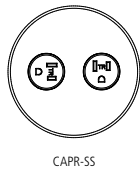
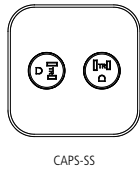
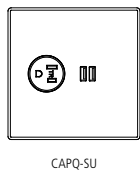
TWO PORT SOFT SQUARE, ROUND OR SQUARE POWER CAP	MODEL #	SHAPE	DESCRIPTION	L x W	SIMPLEX OUTLETS	DUAL USB-A+C	PRICE
 CAPS-SU	CAPS-SU-B-C	Soft Square	Black Simplex	5x5	1	1	1,249
	CAPS-SU-W-C	Soft Square	White Simplex	5x5	1	1	1,249
	CAPR-SU-B-C	Round	Black Simplex	5x5	1	1	1,249
	CAPR-SU-W-C	Round	White Simplex	5x5	1	1	1,249
 CAPR-SU	CAPQ-SU-B-C	Square	Black Simplex	5x5	1	1	1,249
	CAPQ-SU-W-C	Square	White Simplex	5x5	1	1	1,249
	CAPS-SS-B	Soft Square	Black Simplex	5x5	2	-	1,072
	CAPS-SS-W	Soft Square	White Simplex	5x5	2	-	1,072
 CAPQ-SU	CAPR-SS-B	Round	Black Simplex	5x5	2	-	1,072
	CAPR-SS-W	Round	White Simplex	5x5	2	-	1,072
	CAPQ-SS-B	Square	Black Simplex	5x5	2	-	1,072
	CAPQ-SS-W	Square	White Simplex	5x5	2	-	1,072

OPTIONS	CODE	PRICE	NOTES
Polished Chrome Plate	Add -PCP	\$78 per unit	
Field-Wired	Add -FW	Add \$107 per unit	May be required in New York City, Chicago and San Francisco. Check with an electrician for local codes and requirements.

GENERAL INFORMATION

- Available on Radius Square & Round Tops only
- Available at center location only

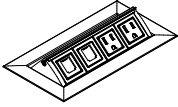
REQUIRED INFORMATION: (ORDER CANNOT BE ENTERED WITHOUT THIS INFORMATION)
 See appendix pages vi-viii for surface material options.
 ▪ Choose Metal Finish (unless Polished Chrome has been specified)



LOCATION CODES	POWER CAP	DESCRIPTION	LOCATION	QUANTITY OF UNITS TO ORDER
	CP4-1	Power Cap 4 Port Racetrack Shape	One at Center	1
	CP4-1W	Power Cap 4 Port Racetrack Shape (Media Table)	One at End (Media Table Only)	1
	CP4-2	Power Cap 4 Port Racetrack Shape	One at Each End	2
	CP4-3	Power Cap 4 Port Racetrack Shape	3 Equally Spaced (starting at 96")	3
	CP4-4	Power Cap 4 Port Racetrack Shape	4 Equally Spaced (starting at 132")	4
	CP2-1	Power Cap 2 Port Racetrack Shape	One at Center	1
	CP2-1W	Power Cap 2 Port Racetrack Shape (Media Table)	One at End (Media Table Only)	1
	CP2-2	Power Cap 2 Port Racetrack Shape	One at Each End	2
	CP2-3	Power Cap 2 Port Racetrack Shape	3 Equally Spaced (starting at 96")	3
	CP2-4	Power Cap 2 Port Racetrack Shape	4 Equally Spaced (starting at 132")	4
	CPS2-1	Power Cap 2 Port Soft Square Shape (Soft Square Tables only)	One at Center	1
	CPR2-1	Power Cap 2 Port Round Shape (Round Tables Only)	One at Center	1
	CPQ2-1	Power Cap 2 Port Square Shape (Square Tables Only)	One at Center	1



POWER AND DATA OPTIONS

TECH NODE	MODEL #	W X D	SIMPLEX RECEPTACLES	OPEN DATA PORTS	CHARGING USB-A+C	PRICE
 PUP	PUP	8 x 4	2	2	-	597
	PUP-USB-AC	8 x 4	2	1	1	711



OPTIONS	CODE	PRICE	NOTES
Field-Wired	Add -FW	No Charge	May be required in New York City, Chicago and San Francisco. Check with an electrician for local codes and requirements.

GENERAL INFORMATION

- PUP option includes two simplex receptacles and two voice/data openings
- PUP-USB-AC option includes two simplex receptacles, one USB-A+C charger and one voice/data opening
- 12' cord and a 15 amp plug-in power Infeed
- Voice/data modules must be ordered separately; contact your local AV integrator
- Default color to metal finish specified on tables (Shadow, Storm, Black, Aged Bronze, Satin Bronze and Galaxy receive Black Anodized Tech Node; Cloud, Burnished and Foil receive Clear Anodized Tech Node)
- UL Listed
- Includes a Voice/Data Adapter Kit to accept couplers and jacks when required

REQUIRED INFORMATION: (ORDER CANNOT BE ENTERED WITHOUT THIS INFORMATION)

- See appendix pages vi-viii for surface material options.
- Choose location code and quantity from chart on page 119



POWER SPEC	MODEL #	DESCRIPTION	PRICE
 PWR-R-W	PWR-R-B	Round Power Spec with Black Faceplate	128
	PWR-R-W	Round Power Spec with White Faceplate	128
 PWR-SQ-W	PWR-SQ-B	Square Power Spec with Black Faceplate	128
	PWR-SQ-W	Square Power Spec with White Faceplate	128

GENERAL INFORMATION

- Includes one simplex receptable
- 12' cord

REQUIRED INFORMATION: (ORDER CANNOT BE ENTERED WITHOUT THIS INFORMATION)

- See appendix pages vi-viii for surface material options.
- Choose Metal Finish: Satin Nickel (SNB) or Chrome (CB)

USB SPEC	MODEL #	DESCRIPTION	PRICE
 USBC-R-W	USBC-R-B	Round Data Spec with Black Faceplate	267
	USBC-R-W	Round Data Spec with White Faceplate	267
 USBC-SQ-W	USBC-SQ-B	Square Data Spec with Black Faceplate	267
	USBC-SQ-W	Square Data Spec with White Faceplate	267

GENERAL INFORMATION

- Includes one charging USB-A+C
- 6' cord

REQUIRED INFORMATION: (ORDER CANNOT BE ENTERED WITHOUT THIS INFORMATION)

- See appendix pages vi-viii for surface material options.
- Choose Metal Finish: Satin Nickel (SNB) or Chrome (CB)



POWER AND DATA OPTIONS

GROMMET	MODEL #	DESCRIPTION	DIAMETER	PRICE
	GR	Round Grommet	2" Dia	242



OPTIONS	CODE	PRICE	NOTES
Polished Chrome Grommet	Add -PCG	\$98 per unit	

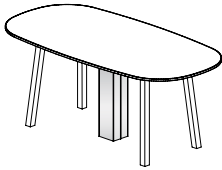
GENERAL INFORMATION

- Available at center location only

REQUIRED INFORMATION: (ORDER CANNOT BE ENTERED WITHOUT THIS INFORMATION)

- See appendix pages vi-viii for surface material options.
- Choose Metal Finish: Powder Coat, Clear Anodized or Polished Chrome (upcharge applies)

POWER POLE	MODEL #	DESCRIPTION	PRICE
	TF-PP	Power Pole	1,019



REQUIRED INFORMATION: (ORDER CANNOT BE ENTERED WITHOUT THIS INFORMATION)

- See appendix pages vi-viii for surface material options.
- Choose Metal Finish (Clear Anodized -CA not available)

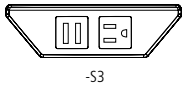
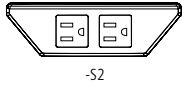
LOCATION CODES	TECH NODE	POWER SPEC	USB SPEC	ROUND GROMMET	LOCATION	QUANTITY OF UNITS TO ORDER
	TN-1	SP-1	SP-1	G-1	One at center	1
	TN-1W	SP-1W	SP-1W	G-1W	One at wall end	1
	TN-2*	SP-2	SP-2		One at each end	2
	TN-3*	SP-3	SP-3		One at center and one at each end	3
	TN-4*	SP-4	SP-4		Four equally spaced	4

*TN-2, TN-3 and TN-4 not offered on Media Tables or Standing Height Tables



POWER AND DATA OPTIONS

HARDWIRE INFEED POWER RAIL KIT	MODEL #	TOTAL # OF RAILS	ELECTRICAL OUTLETS	(2) SIMPLEX -S2	ELECTRICAL OUTLETS	(1) SIMPLEX / (1) CHARGING USB -S3
(Includes Power Rails, Hardwire Infeed and Modular Power Components)	TF-RAIL-1-H	1	2	1,462	1	1,462
	TF-RAIL-2-H	2	4	2,320	2	2,320
	TF-RAIL-3-H	3	6	3,177	3	3,177
	TF-RAIL-4-H	4	8	4,036	4	4,036
	TF-RAIL-5-H	5	10	4,894	5	4,894
	TF-RAIL-6-H	6	12	5,749	6	5,749
	TF-RAIL-7-H	7	14	6,605	7	6,605
	TF-RAIL-8-H	8	16	7,461	8	7,461



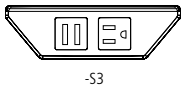
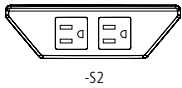
GENERAL INFORMATION

- Includes modular power electrical system
- Hardwire infeed is 7' long
- Simplex receptacles will be white, when Burnished, Cloud or Foil powdercoat finishes are specified. Black simplex receptacles will be used for all other powdercoat finishes.
- Power Rails not available in Clear or Black Anodized

REQUIRED INFORMATION: (ORDER CANNOT BE ENTERED WITHOUT THIS INFORMATION)

- See appendix pages vi-viii for surface material options.
- Choose Metal Finish

CORDED INFEED POWER RAIL KIT	MODEL #	TOTAL # OF RAILS	ELECTRICAL OUTLETS	(2) SIMPLEX -S2	ELECTRICAL OUTLETS	(1) SIMPLEX / (1) CHARGING USB -S3
(Includes Power Rails, Corded Infeed and Modular Power Components)	TF-RAIL-1-C	1	2	1,589	1	1,589
	TF-RAIL-2-C	2	4	2,450	2	2,450
	TF-RAIL-3-C	3	6	3,306	3	3,306
	TF-RAIL-4-C	4	8	4,161	4	4,161
	TF-RAIL-5-C	5	10	5,018	5	5,018
	TF-RAIL-6-C	6	12	5,879	6	5,879
	TF-RAIL-7-C	7	14	6,736	7	6,736
	TF-RAIL-8-C	8	16	7,591	8	7,591



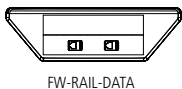
GENERAL INFORMATION

- Includes modular power electrical system
- Corded single infeed is 7' long
- Corded Single Infeed option will require a 20amp outlet in the floor monument and reduces the modular electrical system in the table to a single circuit
- Simplex receptacles will be white, when Burnished, Cloud or Foil powdercoat finishes are specified. Black simplex receptacles will be used for all other powdercoat finishes.
- Power Rails not available in Clear or Black Anodized

REQUIRED INFORMATION: (ORDER CANNOT BE ENTERED WITHOUT THIS INFORMATION)

- See appendix pages vi-viii for surface material options.
- Choose Metal Finish

DATA RAIL	MODEL #	DESCRIPTION	PRICE
	TF-RAIL-DATA	Data Rail includes (1) blank faceplate and (1) dual RJ-45 faceplate	664



GENERAL INFORMATION

- Data Rails not available in Clear or Black Anodized

REQUIRED INFORMATION: (ORDER CANNOT BE ENTERED WITHOUT THIS INFORMATION)

- See appendix pages vi-viii for surface material options.
- Choose Metal Finish



POWER AND DATA OPTIONS

FIELD-WIRED	MODEL #	DESCRIPTION	(2) SIMPLEX -S2	(1) SIMPLEX / (1) CHARGING USB -S3
	TF-RAIL-FW	Field-Wired Power Rail	764	764

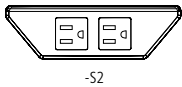
GENERAL INFORMATION

- Includes 6' flexible metal conduit and required a hardwire connection
- May be required in New York City, Chicago and San Francisco. Check with an electrician for local codes and requirements. A junction box will be provided when ordering the TW-RAIL-FW option.
- Power Rails not available in Clear or Black Anodized

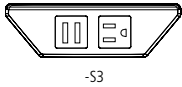
REQUIRED INFORMATION: (ORDER CANNOT BE ENTERED WITHOUT THIS INFORMATION)

- See appendix pages vi-viii for surface material options.
- Choose Metal Finish

INDIVIDUAL POWER RAIL	MODEL #	DESCRIPTION	(2) SIMPLEX -S2	(1) SIMPLEX / (1) CHARGING USB -S3
	TF-RAIL	Power Rail	861	861



-S2



-S3

GENERAL INFORMATION

- Individual power rails do not include a modular power system. Each Power Rail must directly plug into a floor core with a 6'-corded 15-amp plug-in infeed. (Typically used with smaller tables, rounds, squares, soft squares, where a modular power system is not required.)
- Simplex receptacles will be white, when Burnished, Cloud or Foil powdercoat finishes are specified. Black simplex receptacles will be used for all other powdercoat finishes.
- Power Rails not available in Clear or Black Anodized

REQUIRED INFORMATION: (ORDER CANNOT BE ENTERED WITHOUT THIS INFORMATION)

- See appendix pages vi-viii for surface material options.
- Choose Metal Finish

CHARGING TRAC	MODEL #	TOTAL BRACKETS	# OF USB PORTS	PRICE
	TRAC-2	2	4	2,216
	TRAC-4	4	8	3,738



GENERAL INFORMATION

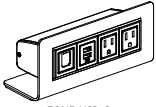
- Plug-in Infeed only
- Field Installed
- 15 amp

REQUIRED INFORMATION: (ORDER CANNOT BE ENTERED WITHOUT THIS INFORMATION)

- See appendix pages vi-viii for surface material options.
- Choose Metal Finish



POWER AND DATA OPTIONS

TECH ZONE	MODEL #	DESCRIPTION	SIMPLEX OUTLETS	OPEN DATA PORTS	CHARGING USB-A+C	PRICE
 ZONE-USB-C	ZONE-DATA	(2) Simplex receptacles, (2) Open data ports	2	2	-	375
	ZONE-USB-C	(2) Simplex receptacles, (1) Charging USB-A+C, (1) Open data port	2	1	1	449

GENERAL INFORMATION

- 72" long plug-in infeed cord
- Finish is black
- Includes a Voice/Data Adapter Kit to accept couplers and jacks when required



ZONE-DATA



ZONE-USB-C

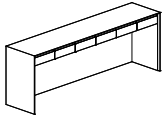
VIDEO CONFERENCE CAMERA SHELF	MODEL #	W x D	PRICE
 NEVC-1407	NEVC-1407	14 x 7	487

GENERAL INFORMATION

- Shelf is 1/4" thick Foil powder coated aluminum and can be positioned at any height
- Field installed
- Camera shelf is not available on Freestanding and Height Adjustable Media Tables



VENEER TOP WITH HARDWOOD EDGE



CONSOLE
TFDC-8430

SURFACE MATERIAL KEY

V Veneer

CONSOLE

MODEL #	WIDTH	LENGTH	HEIGHT	# OF DRAWERS	-V
TFDC-5626	56	19	26	4 Drawers	3,741
TFDC-7026	70	19	26	5 Drawers	4,230
TFDC-8426	84	19	26	6 Drawers	4,719
TFDC-5630	56	19	30	4 Drawers	4,303
TFDC-7030	70	19	30	5 Drawers	4,865
TFDC-8430	84	19	30	6 Drawers	5,426

GENERAL INFORMATION

- White drawer boxes with under-mount self soft-closing slides
- Overall drawer dimensions are 15" x 12.5" x 3.25". Interior drawer box dimensions are 14" x 11.5" x 2.5".
- Standard with quarter cut veneer

REQUIRED INFORMATION (ORDER CANNOT BE ENTERED WITHOUT THIS INFORMATION)

See appendix pages vi-viii for surface material options.

- Choose Veneer Finish



Appendix



GENERAL INFORMATION

This price book supercedes all previous versions.

Before placing your order, confirm you have all required information necessary. Lead times for orders begin after all required information is included and correct.

Delivery Information

We know lead times are important and sticking to them even more so. We work to maintain a 6-8 week lead time on all standard products in this book from receipt of a clean order. All orders are acknowledged with an approximate shipping date and will be invoiced with the price in effect at the date the purchase order is received. For current lead times, please review www.nucraft.com/resources/lead-times.

Shipping charges are prepaid (within the continental U.S.). Therefore, pricing is a delivered price based on normal ground transportation. If you have special instructions, need to ship by air, or are shipping to Alaska or Hawaii, contact Nucraft Customer Service. Nucraft can also help arrange to have products blanket wrapped for an additional charge. Contact the Nucraft Customer Service team or specify it on your purchase order.

Minimum Freight Charge: Any order below \$3,000 net will be assessed a \$500 net minimum freight charge (one per order).

Orders are subject to acquiring the materials required for manufacturing. Fulfillment can be affected by strikes, fires, embargoes and acts of government. These elements are beyond our control.

Nucraft offers a variety of services to accommodate a wide range of delivery requirements. Availability of these services is dependent on a number of factors and may not be offered with all shipments. Examples of delivery services that have additional fees include:

- Specific date
- Specific time of day, morning or afternoon
- Delivery to a warehouse before delivery to its final destination (unless product is picked up at the warehouse)

Contact the Nucraft Customer Service team for availability and pricing on these services.

Freight Terms

Shipping charges for Nucraft products are prepaid for standard delivery in the continental United States. Standard delivery is defined as follows: Product is delivered on a 53' trailer being pulled by a long-haul tractor (total length of 85'). Facility will receive delivery Monday through Friday between the hours of 8:00 AM and 4:00 PM. Facility has docks with levelers and a fork truck for unloading. Product will be loaded on load bars two levels high. Receiving facility is responsible to have personnel on hand to unload the truck upon arrival, drivers do not unload. Delivery sites or times that do not meet these criteria may be accommodated, but will incur a charge to cover additional shipping costs. Please **notify Nucraft a minimum of two weeks prior to shipment** to arrange special services and determine additional charges.

Storage

Nucraft has no storage facilities for finished product. If a customer cannot accept an order when it is ready for shipment, the customer must designate an alternative shipping address. If no address is provided, Nucraft may, at its discretion, transfer the product to storage. If product is transferred to an off-site storage facility, the customer may be charged for transportation to the facility and for any associated storage fees. Nucraft considers transfer of the product to a storage facility the equivalent of shipment, including invoicing and payment. Customers assume the risk of damage or loss during storage.

Transportation Times and Delays

Third party carriers that Nucraft contracts with will make reasonable efforts to accommodate requested delivery times and dates. Scheduled delivery appointments may, however, be delayed for a variety of reasons, including inclement weather, traffic, transportation equipment problems, and delays encountered at other delivery locations along the delivery route. Nucraft does not recommend scheduling activities that depend on the delivery appointment (for example, scheduling furniture installers to install furniture the day of the delivery appointment). Nucraft shall not be liable for any costs incurred as a result of a missed delivery appointment.

Shipment Damage Claims

Legal title to merchandise passes to the buyer upon acceptance by the carrier. Inspect all cartons upon delivery. Details of visible damage should be noted on the delivery receipt. Do not destroy packaging, transport to site, or install product if damage is found upon inspection. Inspection of products should be completed upon delivery to the receiver. If visible damage is apparent, a claim should be filed immediately with Nucraft Customer Service. If visible damage is not apparent, sign the delivery receipt "No visible damage." This will allow recourse for a concealed damage claim. Concealed damage claims must be filed within 15 days of receipt, **prior to transporting or installing any product.**

Do not destroy packing materials until shipment has been inspected. If damage is found, proceed to file a claim with Nucraft Customer Service.

Failure to make any claims against Nucraft within 15 days shall constitute acceptance of the merchandise and a waiver of any defects, errors or shortages discovered upon inspection.

Cancellations

Cancellations must be reviewed by our Customer Service team. Because we build your products to order, orders cannot be cancelled once processing has begun. Processing includes but is not limited to development of shop drawings and other engineering drawings. If cancellation is approved, a processing fee of 20-100% will be assessed based on the status of the order.

Change Order Policy

Nucraft will make every attempt to honor any reasonable change request to product provided that the request is received prior to start of production. Change orders will be accepted only if the request is made in writing and received in time to make the change. Nucraft reserves the right to increase our acknowledged price and ship date if necessary to make the requested changes. Please submit any change order request to our Customer Service team. Nucraft will assess charges to the customer as stipulated in the following:

- Standard Orders: Change orders received prior to production will be charged \$400 net to cover administrative costs.
- Special Orders: Change orders received prior to production will be charged \$400 net to cover administrative costs. There may be additional costs associated with engineering labor required for the change order.
- Change orders received after production must be evaluated by Nucraft. If approved, the charge will be \$400 net plus any restocking charges accumulated. There may be additional costs associated with engineering and/or manufacturing labor, as well as material costs, required for the change order.



GENERAL INFORMATION

Repair Authorization

Prior written approval is required for repairs of merchandise charged to Nucraft. Failure to do so will result in customer funded repairs.

Payment Terms

Deposits are required at the time of order due to the custom nature of our products. See information regarding Cancellations above.

Credit terms are available to qualified customers. Please contact AR@Nucraft.com to start the application process. Note that the credit application process requires a valid sales tax exemption or resale tax certificate, Form W-9, and three current trade references.

Credit Card Payments are accepted via web portal. Please contact AR@Nucraft.com for payment instructions. Note that a 2% convenience fee will be added for using this payment method and no early pay discounts are allowed on credit card payments.

Warranty

Nucraft Furniture is warranted to be free from defects in materials and workmanship for a period of ten years of single shift use. Limitations include:

- Mechanical Devices such as latches, casters, and other moving components are warranted for five years of the date of original delivery.
- Height adjustable components are warranted for two years of the date of original delivery.
- The following are warranted for one year of the date of original delivery:
 - Textiles
 - Electrical Components
 - Refrigeration Units
 - Custom Products not described in Nucraft's Catalogue

This warranty is applicable only if furniture is properly installed and maintained in an office environment. This warranty extends only to products manufactured and sold in North America and only to original purchasers acquiring new Nucraft product through authorized dealers or approved sellers.

During this warranty period, Nucraft's sole obligation is to repair or replace, at Nucraft's discretion, products which prove to be defective during the warranty period.

This warranty does not cover:

- Damage caused by a carrier.
- Damage from user modification, misuse, abuse, accident, or negligence.
- Customer's Own Material (COM) specified by the customer that is not a standard product offering.
- Color, grain, or texture of wood and other covering material.

Nucraft extends no other warranties, expressed or implied, including warranty of merchantability or fitness for a particular purpose. Nucraft shall not be liable for loss of time, inconvenience, commercial loss, incidental or consequential damages.

Environmental Statement

Nucraft is committed to supporting responsible environmental policies and practices in all that we do. We strive for sustainability, weighing our business decisions against the costs to the ecological, social and economic systems they affect.

Our products are manufactured to meet the credit requirements of the U.S. Green Building Council's LEED rating systems in one or more of the following categories:

- Recycled Content
- Certified Wood
- Low-Emitting Materials

Computer Aided Planning

Nucraft products and pricing are available via CET and 2020 Worksheet, an AutoCAD®-based space planning tool.

2020 Worksheet is an integrated software system developed specifically for interior designers and facility planners to enhance workplace performance. This modern suite of applications works together seamlessly, in concert. Navigate catalogs, select products, design in plan view and 3D, assign options, create worksheets and build a project where you want, when you want. Take your pick. It's dynamic and interactive. Design projects are a work in progress. And now you can perform any of the many discrete tasks that go into a project any time, any place.

Product symbols (Revit, 2D and 3D) are available on the Nucraft website at www.nucraft.com/resources/designer-tools/product-symbols.

iSpec®

Nucraft offers a free online product configuration and specification service that saves you time and allows you to be creative while leaving the nuts and bolts to someone else. No specific software is required, nor is there any learning curve. This service applies to all Nucraft products. For additional information, visit www.nucraft.com/resources/designer-tools/ispec.



FINISH INFORMATION

Surface Materials Palette

We crafted our materials palette using the same demanding standards that distinguish our furniture. Thoughtful design and attention to every detail elevate your possibilities.

Anchored by Nucraft veneers, unrivaled for clarity, quality, and depth of finish, our collection of surface materials comprises a sophisticated set of balanced elements that supports your design vision.

Some elements have their roots in Nucraft's rich heritage. Others are new materials and reflect current trends and taste. Together, they ensure that you're ready for today and positioned well for the future. Beautifully.

Custom Finishes

Nucraft specializes in expert custom finish matching. For a nominal upcharge we can provide custom finishes, and we are frequently asked to match the finishes of other furniture manufacturers. For finishes that appear unusual to match or for customers directly requesting a sample, a finish sample will be sent for approval prior to entering the order.

Custom finishes requiring colored varnishes to create a painted look can only be applied to Maple veneer and require one extra week in addition to the standard lead time. Nucraft's standard black finish (G82) can be applied to all Nucraft standard veneers. Walnut is the standard black veneer. Other species must be specified when ordering.

Clear coat on a special veneer requires an approved sample.

Custom finishes carry a 10% upcharge per item, per finish, capped at \$2,200 List.

Custom finish upcharges are not applied to any item that is not wood. Example: casters, ganging connectors, power options.

Treatments

Note: Default veneer sheen will vary per finish and product. Default finish is bolded on pages vi-vii. If no direction is provided on incoming orders, default sheen will be selected. In addition, default veneer cut is noted in the price list. If no direction is provided on incoming orders, default cut will be selected.

Gloss: Gloss is a durable finish that tends to nicely mask normal wear and leaves wood grain visible to the eye. It achieves a medium gloss open pore appearance (40 – 50 sheen range). Finish numbers preceded by the letter "G" indicate a Gloss finish.

Matte: Like Gloss, Matte is durable, tends to nicely mask normal wear and leaves wood grain visible to the eye. It achieves a low luster, open pore appearance (10 – 20 sheen range). Finish numbers preceded by the letter "M" indicate a Matte finish.

Since each veneer type responds differently to both types of treatment, all will have a distinctive look and feel when finished. For example, a Walnut veneer with a Gloss treatment will remain much more textured than a Cherry veneer with the same treatment.

About the Wood

All Nucraft veneers are carefully selected for uniformity of color and grain. Still, wood is a natural substance and minor variations may occur due to its own uniqueness. Because of this, the furniture you receive may not be an exact match to our samples.

Nucraft takes great pride in our finish color consistency. However, wood is a natural product that will have color variation within a single piece of furniture, as well as from one piece to the next. Other factors also affect color over time, such as exposure to light (both intensity and duration). For example, lighter finishes cause more variation in colors over time.

In cases where a returning customer wants a precise match with existing furniture, we recommend sending a sample of the existing furniture finish. Please contact Nucraft Customer Service to determine an appropriate sample. This will ensure a finish match between old and new orders. This type of order is considered a control sample. There will be a 10% upcharge on an order of this type. Due to natural aging of veneers, natural finishes may vary.

Care and Maintenance of Wood Finishes

Our finish material is a crystal clear, urethane acrylic blend. This type of finish may be repaired in the field by a qualified refinisher.

Nucraft recommends using a damp cloth to clean your fine wood furniture. Always wipe with the grain of the wood. Should your wood furniture require a more thorough cleaning, we recommend using a mild cleaner such as Joy dish soap or Murphy's oil soap, thoroughly diluted in water (one part soap to thirty parts water). Water will not damage Nucraft's finish, but it may leave surface spots when it dries. To avoid this, dry the surface with a soft cloth after it is cleaned. Marks that cannot be removed with the cleaning methods above may be able to be removed using naphtha, a mild degreasing solvent.

Caution: while the use of polishes that contain wax, petroleum solvents or silicones may immediately enhance the "shine" of a product, it may also eventually remove the fine original finish applied in our factory. Silicone on the surface of wood may also make it very difficult to respray or refinish.

All Nucraft furniture is inspected and polished before it leaves our factory. In some instances, the packing materials may imprint on the factory polish. Cleaning and polishing the furniture once it is unpacked will normally restore the furniture to its original beauty.

In some cases, the rubber support feet used on the bottom of common office equipment (teleconferencing phones, laptops, microphones, copiers, etc.) can create unsightly marks in the surface of wood tops, due to oxidation of the lacquer finish. We suggest these machines be placed on a protective type of padding, such as felt.

Wood will fade as a result of exposure to UV light. This is particularly prevalent with light finishes. If color changes due to fading are a concern for your application, the impact can be minimized by selecting medium to dark stains for your wood surfaces. Our top coat includes a UV inhibitor which makes the finishes less prone to fading.



FINISH INFORMATION

Laminates

Selected Formica®, Nevamar®, and Wilsonart® laminates are available on Training Tables, Conference Tables, Conference Room Furniture and select Occasional Tables. For standard laminate and wood pricing, refer to individual item pricing columns. It is important to note that wood grain laminates are unable to be grain matched over multi-piece table top applications.

Non-Standard Laminates and Linoleums

To order a color other than those on our list (see pages vi-vii), refer to Nevamar or Formica standard grade, matte texture laminate offerings and Forbo Furniture Linoleums (excluding manufacturers' non-standard matte offering).

Nucraft can support other laminate and linoleum options beyond what can be found as standard options on pages vi-viii. For pricing, please send a request to quotes@nucraft.com.

Care and Maintenance of Laminate and Novawrap

Laminate and Novawrap surfaces may be cleaned with a damp cloth and ordinary soap or non-abrasive household liquid detergent. Dry the surface with a clean cloth or soft paper towel to prevent streaks from appearing.

Care and Maintenance of Metal

Metal surfaces can be wiped with a damp cloth and rubbed dry. A mild non-abrasive household liquid detergent can be used if necessary. Regular maintenance of metal components, including tightening of fasteners and light lubrication of moving parts, will extend the life of your furniture.

Satin Etched Glass

Glass color may vary slightly on multi-piece conference table tops over 180" x 60" when satin etched glass is specified due to the iron content and etching process of the glass.

Care and Maintenance of Glass

Clear or frosted glass may be cleaned with commercial glass cleaner. Be sure to use a lint-free cloth if cleaning the frosted side of the glass.

Stone and Solid Surface Material

Despite its reputation for durability, natural stone can easily be broken during handling and/or installation if proper techniques are not followed. In addition, Nucraft is not responsible for the installation of natural stone or solid surface materials on its products. Therefore, installers specifically trained in the installation of these materials must be utilized to ensure a quality installation. Nucraft shall not be liable for any damages incurred during the handling and/or installation of natural stone or solid surface materials on its products.

Care and Maintenance of Granite

Granite surfaces may be cleaned with a damp cloth and ordinary soap or non-abrasive household liquid detergent. Dry the surface with a clean cloth or soft paper towel to prevent streaks from appearing.

Care and Maintenance of Leather

Genuine leather requires very little care. Nucraft recommends that leather be dusted regularly. If a more thorough cleaning is needed, use lukewarm water and a mild, non-abrasive soap. Generate some lather and lightly rub the surface with cheesecloth. Rinse off any soap film with clean water and towel dry. The leather may dry dull. To restore the leather to a normal gloss, rub it with a clean towel. Never use furniture polish, oil, varnish or ammonia. Saddle soap may be used to prevent the leather from becoming brittle or cracked and to maintain the original supple finish.

Touch Up Finish Kits

Model #	Description	Price
KIT-M	Metal Kit	85
KIT-P	Paint Kit	85
KIT-S	Stain Kit	85

REQUIRED INFORMATION: (ORDER CANNOT BE ENTERED WITHOUT THIS INFORMATION)

- Kit model number
- Quantity of kits
- Specify finish (See pages vi-vii)

General Information:

- Touch-up kits must be ordered on a purchase order separate from Nucraft product due to Hazmat shipping

Retrofit & Replacements

If needing a partial placement or retrofit solution, please reach out to our quote team. Grain/color matched in a set.



VENEER

Default veneer sheen will vary per finish and were determined by a team of experts who reviewed the colorways to determine if gloss or matte best highlighted the natural characteristics of the species of wood and the color of the stain. Default finish is bolded. If no direction is provided, default sheen will be selected.

	Matte	Gloss
Rift Cut Oak		
Carbon	M03	G03

	Matte	Gloss
Flat Cut Oak		
Artisan	M68	G68
Coco	M67	G67
Dove	M66	G66
Dune	M05	G05
Midnight	M69	G69
Portobello	M7413	G7413
Winter	M70	G70

	Matte	Gloss
Flaky Oak		
Sahara	M61	G61

	Matte	Gloss
Cherry		
Auburn	M93	G93
Cognac	M21	G21

	Matte	Gloss
Walnut		
Marron	M35	G35
Mocha	M33	G33
Onyx	M82	G82
Otter	M31	G31
Zinc	M30	G30

	Matte	Gloss
Maple		
Natural Maple	M60	G60

	Matte	Gloss
Linea		
Euro Birch Linea	M09	G09
Oak Linea	M08	G08
Silver Birch Linea	M10	G10
Walnut Linea	M27	G27

	Matte	Gloss
Paldao		
Canyon	M77	G77
Paldao	M76	G76
Thicket	M75	G75

LAMINATE

Coordinating wood finish and edgeband options listed below.

		Solid Edge Band
Solid Laminates		
Formica Brite White	459-58	R01
Formica Dover White	7197-58	R01
Formica Folkstone	927-58	R03
Formica Graphite	837-58	R05
Formica Graystone	464-58	R02
Formica Pearl	934-58	R02

Patterned Laminates		
Nevamar Calm Distinction	VA6001T	R05
Nevamar Cool Chic	VA7002T	R02
Nevamar Easy Elegance	VA5002T	R05
Nevamar Serene Stardom	VA5001T	R05
Wilsonart Sheer Mesh	4876-38	R02
Wilsonart Grey Mesh	4877-38	R02
Wilsonart Pewter Mesh	4878-38	R05

		Wood Finish	Woodgrain Edge Band
Wood Grain Laminates			
Formica Aged Ash	8844-58	M8844	R8844
Formica Blackened Legno	8848-58	M8848	R8848
Formica Bleached Legno	8845-58	M8845	R8845
Formica Chestnut Woodline	5884-58	M5884	R5884
Formica Espresso Pear	5489-58	M5489	R5489
Formica Natural Ash	8843-58	M8843	R8843
Formica Oiled Legno	8846-58	M8846	R8846
Formica Pecan Woodline	5883-58	M5883	R5883
Formica Planked Coffee Oak	7413-58	M7413	F7413
Formica Sand Maple	9237-58	G60	W7909
Formica Smoky Brown Pear	5488-58	M5488	R5488
Formica Thermo Walnut	6402-58	M6402	R6402
Formica Urban Planked Oak	9312-58	M9312	R9312
Formica Weathered Ash	8842-58	M8842	R8842
Formica White Ash	8841-58	M8841	R8841

GLASS

	Satin	Gloss
Satin or Gloss Glass		
Black	BS	-
Clove	VS	VG
Meringue	MS	MG
Moonlight	MLS	MLG
Storm	STS	STG
Quill	QS	QG
White	WS	WG



TWO4SIX® SURFACE MATERIALS

STONE

Stone orders may affect lead times. Standard Cambria finish is polished. For alternative finish options, please contact Nucraft Customer Service.

Stone	Subtop Paint	
Absolute Black Honed Granite	ST01	S8007
Carrara Marble	ST16	S8004

Quartz | Cambria® Signature

Ainsley	STC100	S8004
Armitage	STC101	S44
Avalene	STC192	S8004
Bellingham	STC102	S8004
Berkeley	STC103	S8004
Berwyn	STC104	S8004
Blackbrook	STC105	S44
Bradshaw	STC106	S8004
Bradwell	STC107	S8004
Cambria Black	STC109	S44
Carrick	STC110	S44
Charlestown	STC207	S44
Charston	STC208	S44
Clifton	STC112	S8004
Colton	STC113	S8004
Copeland	STC200	S8004
Crowndale	STC114	S8004
Devon	STC115	S44
Dovestone	STC209	S8004
Fairbourne	STC116	S8004
Fieldstone	STC117	S44
Hadley	STC201	S44
Halewood	STC119	S8004
Hermitage	STC120	S8004
Kendal	STC122	S8004
Laneshaw	STC124	S44
MacBeth	STC202	S8004
Malvern	STC125	S8004
Montgomery	STC128	S8004
New Quay	STC130	S8004
Pendle Hill	STC131	S8004
Praa Sands	STC132	S8004
Ridgegate	STC203	S8004
Rose Bay	STC133	S8004
Sandgate	STC135	S8004
Seacourt	STC204	S8004
Smithfield	STC136	S8004
Sutherland	STC138	S8004
Swanbridge	STC139	S8004
Torquay	STC140	S8004
Trafalgar	STC205	S8004
Travella	STC141	S8004
Weybourne	STC143	S8004
Whitendale	STC206	S8004
Whitney	STC144	S8004
Woodcroft	STC146	S44

Quartz | Cambria® Luxury

Abbey	STC147	S8004
Annicca	STC148	S8004
Beckington	STC150	S8004
Bentley	STC151	S8004
Brighton	STC212	S8004
Brittanicca	STC153	S8004
Brittanicca Gold Cool	STC154	S8004
Brittanicca Gold Warm	STC155	S8004
Brittanicca Warm	STC156	S8004
Claremont	STC215	S8004
Clovelly	STC158	S8004
Delamere	STC159	S44
Delgatie	STC160	S8004
Ella	STC161	S8004
Everleigh	STC162	S8004
Everleigh Warm	STC191	S8004
Gladstone	STC163	S8004
Golden Dragon	STC164	S44
Hailey	STC165	S8004
Harlow	STC166	S8004
Hemsworth	STC167	S8004
Huntley	STC168	S8004
Inverness Blakeley	STC190	S8004
Inverness Bristol Bay	STC169	S8004
Inverness Bronze	STC170	S8004
Inverness Cobalt	STC171	S8004
Inverness Everleigh	STC172	S8004
Inverness Frost	STC196	S8004
Inverness Gold	STC197	S8004
Inverness Platinum	STC173	S8004
Inverness Swansea	STC174	S8004
Ironsbridge	STC175	S8004
Iverness Frost	STC176	S8004
Iverness Gold	STC177	S8004
Kenwood	STC216	S8004
Lakedale	STC179	S8004
Mayfair	STC181	S8004
Mersey	STC182	S44
Notting Hill	STC183	S8004
Oakleigh	STC184	S8004
Portrush	STC185	S8004
Queen Anne	STC186	S8006
Skara Brae	STC187	S8004
Southport	STC188	S8004
White Cliff	STC189	S8004



TWO4SIX® SURFACE MATERIALS

Quartz | Cambria® Coordinates

Big Sur Mist	STC221	S8004
Black Rock	STC223	S44
Foggy City	STC220	S8004
Mammoth Cave	STC222	S44
Minnesota Snow	STC219	S8004
Salt Lake	STC218	S8004
St. Isley	STC213	S8004
Traymore Bay	STC214	S8004

Quartz | Wilsonart

Carrara Codena	ST21	S8004
Serene	ST17	S8004

SOLID SURFACE

Wilsonart Designer White	ST11
--------------------------	------

METAL

Powder Coat

Aged Bronze	A8010
Black	A44
Burnished	A8009
Cloud	A8004
Foil	A8006
Galaxy	A8007
Moonlight	A87
Satin Bronze	A8011
Shadow	A8005
Storm	A8012

Metal

Clear Anodized*	CA
Polished Chrome (upcharge applies)	PC

*Not available on Open Frame Base.

PAINT

Aged Bronze	S8010
Black	S44
Burnished	S88
Cloud	S8004
Foil	S8006
Galaxy	S8007
Moonlight	S87
Satin Bronze	S8011
Shadow	S8005
Storm	S8012

Paint to Match

To request a custom paint color, contact Nucraft Customer Service. A paint sample must be matched and approved prior to order.

EDGE BAND

Ashen	R04
Parchment	R02
Shale	R05
Stone	R03
Whitecap	R01